

TNC ATTENUATOR
17 DB 3 GHZ 1W

R412.517.124
Series : ATTENUATOR

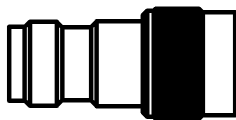

SCALE 1/1

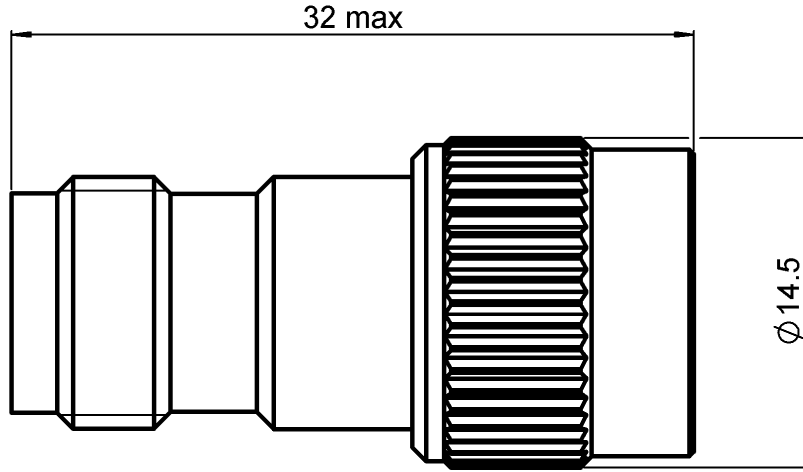
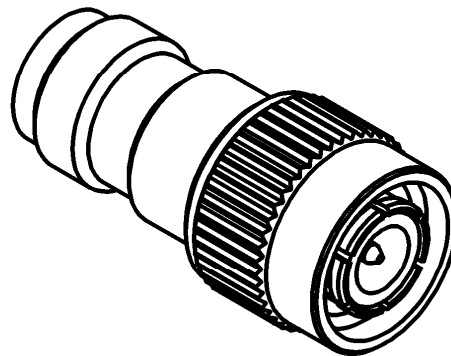

All dimensions are in mm.

COMPONENTS	MATERIALS	PLATING(µm)
BODY	BRASS	NICKEL 2
MALE CENTER CONTACT	BRASS	GOLD 1 OVER NICKEL 2
FEMALE CENTER CONTACT	BERYLLIUM COPPER	GOLD 1 OVER NICKEL 2
OUTER CONTACT		
INSULATOR	PTFE	
GASKET	SILICONE RUBBER	
SUBSTRATE	ALUMINA	
RESISTOR	THICK FILM	
OTHERS PARTS		

Issue : 0827 A

In the effort to improve our products, we reserve the right to make changes judged to be necessary.



TNC ATTENUATOR
17 DB 3 GHZ 1W

R412.517.124
Series : ATTENUATOR

ELECTRICAL CHARACTERISTICS

Frequency (GHz)	DC - 2	2 - 3
V.S.W.R (≤)	1.20	1.30
Deviation(±dB)	0.70	0.70

Operating Frequency Range	DC - 3	GHz
Impedance	50	Ω
Nominal Attenuation	17	dB
Peak power at 25°C (1μs, 1%)	100	W
Average power at 25°C	1	W (Free Air Cooled)
		W (Conduction Cooled)

MECHANICAL CHARACTERISTICS

Connectors	TNC	Male Female	MIL-C 39012
Weight	16,7650 g		

ENVIRONMENTAL CHARACTERISTICS

Operating temperature range	-40 / +85 °C
Storage temperature range	-40 / +85 °C



SPECIFICATION

OTHER CHARACTERISTICS

Issue : 0827 A

In the effort to improve our products, we reserve the right to make changes judged to be necessary.

