



CORDIC IP Core

User Guide

FPGA-IPUG-02044 Version 1.4

July 2018

Contents

Acronyms in This Document	5
1. Introduction	6
2. Quick Facts	7
3. Features	12
4. Functional Description	13
4.1. General Description of the CORDIC Algorithm	13
4.2. Block Diagram	15
4.2.1. Data Path	15
4.2.1.1. Pre-processor	15
4.2.1.2. CORDIC Arithmetic Unit	15
4.2.1.3. Arctan ROM	15
4.2.1.4. Controller	15
4.2.1.5. Post-processor	15
4.2.1.6. Rounding	16
4.2.2. CORDIC Functions	16
4.2.2.1. Vector Rotation	16
4.2.2.2. Vector Translation	17
4.2.2.3. Sin and Cos	17
4.2.2.4. Arctan	18
4.3. Interface Diagram	18
4.4. Configuring the CORDIC IP Core	19
4.4.1. Basic Options	19
4.4.1.1. Architecture Specification	19
4.4.1.2. Iterations Specification	20
4.4.1.3. Pre-rotation Specification	20
4.4.1.4. Compensation Specification	20
4.4.2. Advanced Options	20
4.4.2.1. Round Method Specification	20
4.4.2.2. Input/Output Width Specification	21
4.4.2.3. Data Format Specification	21
4.4.2.4. Phase Format Specification	21
4.4.2.5. Synthesis Options Specification	22
4.5. Timing Specification	22
5. Parameter Settings	24
5.1. Basic Options Tab	24
5.1.1. Mode	25
5.1.2. Architecture	25
5.1.3. Iterations	25
5.1.4. Compensation	25
5.1.5. Pre-Rotation	25
5.2. Advanced Options Tab	25
5.2.1. Data Width	25
5.2.2. Rounding	25
5.2.3. Optional Ports	25
5.2.3.1. Synchronous Reset	25
5.2.3.2. Clock Enable	26
5.2.4. Synthesis Options	26
5.2.4.1. Frequency Constraints (MHz)	26
5.2.4.2. Pipelining and Retiming	26
6. IP Core Generation	27
6.1. Licensing the IP Core	27
6.2. Getting Started	27

6.3.	IPexpress-Created Files and Top Level Directory Structure	29
6.4.	Instantiating the Core	30
6.5.	Running Functional Simulation	30
6.6.	Synthesizing and Implementing the Core in a Top-Level Design	31
6.7.	Hardware Evaluation	32
6.7.1.	Enabling Hardware Evaluation in Diamond	32
6.7.2.	Enabling Hardware Evaluation in ispLEVER	32
6.8.	Updating/Regenerating the IP Core.....	32
6.8.1.	Regenerating an IP Core in Diamond.....	32
6.8.2.	Regenerating an IP Core in ispLEVER.....	33
7.	Core Verification.....	34
	References.....	35
	LatticeEC/ECP	35
	LatticeECP2M.....	35
	LatticeECP3	35
	LatticeSCM.....	35
	LatticeXP	35
	LatticeXP2	35
	Technical Support Assistance	36
	Appendix A. Resource Utilization	37
	LatticeEC Devices.....	37
	LatticeECP Devices.....	38
	LatticeECP2 Devices.....	38
	LatticeECP2M Devices	38
	LatticeECP3 Devices.....	39
	LatticeSC and LatticeSCM Devices	39
	LatticeXP Devices.....	39
	LatticeXP2 Devices.....	40
	ECP5 (LFE5U) Devices	40
	ECP5 (LFE5UM) Devices	40
	ECP5-5G (LFE5UM5G) Devices.....	41
	Revision History.....	42

Figures

Figure 4.1. CORDIC IP Core Block Diagram	15
Figure 4.2. Vector Rotation.....	16
Figure 4.3. Vector Translation.....	17
Figure 4.4. Top-Level Interface for CORDIC IP Core.....	18
Figure 4.5. Basic CORDIC Arithmetic Unit.....	19
Figure 4.6. Timing Diagram for Parallel CORDIC (Rotation Mode) with Continuous Input.....	22
Figure 4.7. Timing Diagram for Parallel CORDIC (Sin/Cos Mode) with Gapped Inputs.....	22
Figure 4.8. Timing Diagram for Serial CORDIC (Translation Mode)	23
Figure 5.1. CORDIC Basic Options Tab	24
Figure 5.2. CORDIC Advanced Options Tab.....	25
Figure 6.1. IPexpress Dialog Box	28
Figure 6.2. Configuration Interface (Diamond Version).....	29
Figure 6.3. LatticeECP2M CORDIC IP Core Directory Structure	29

Tables

Table 2.1. Cordic IP Core for LatticeECP Devices Quick Facts.....	7
Table 2.2. CORDIC IP Core for LatticeECP2 Devices Quick Facts.....	7
Table 2.3. CORDIC IP Core for LatticeECP2M Devices Quick Facts	8
Table 2.4. CORDIC IP Core for LatticeECP3 Devices Quick Facts.....	8
Table 2.5. CORDIC IP Core for LatticeSC/M Devices Quick Facts	9
Table 2.6. CORDIC IP Core for LatticeXP Devices Quick Facts.....	9
Table 2.7. CORDIC IP Core for LatticeXP2 Devices Quick Facts.....	10
Table 2.8. CORDIC IP Core for ECP5 (LFE5U)Devices Quick Facts	10
Table 2.9. CORDIC IP Core for ECP5 (LFE5UM) Devices Quick Facts.....	11
Table 2.10. CORDIC IP Core for ECP5-5G (LFE5UM5G) Devices Quick Facts.....	11
Table 4.1. Vector Rotation Input/Output	16
Table 4.2. Vector Translation Input/Output	17
Table 4.3. Sin and Cos Input/Output	17
Table 4.4. Arctan Input/Output	18
Table 4.5. Top-Level Definitions	18
Table 4.6. Round Method	20
Table 5.1. Parameter Specifications for the CORDIC IP Core.....	24
Table 6.1. File List	30
Table A.1. Parameter Settings of the Evaluation Packages	37
Table A.2. Performance and Resource Utilization (LatticeEC)*	37
Table A.3. Performance and Resource Utilization (LatticeECP)*	38
Table A.4. Performance and Resource Utilization (LatticeECP2)*	38
Table A.5. Performance and Resource Utilization (LatticeECP2M)*	38
Table A.6. Performance and Resource Utilization (LatticeECP3)*	39
Table A.7. Performance and Resource Utilization (LatticeSC and LatticeSCM)*	39
Table A.8. Performance and Resource Utilization (LatticeXP)*	39
Table A.9. Performance and Resource Utilization (LatticeXP2)*	40
Table A.10. Performance and Resource Utilization (ECP5 (LFE5U))*	40
Table A.11. Performance and Resource Utilization (ECP5 (LFE5UM))*	40
Table A.12. Performance and Resource Utilization (ECP5-5G (LFE5UM5G))*	41

Acronyms in This Document

A list of acronyms used in this document.

Acronym	Definition
CORDIC	Coordinate Rotation Digital Computer
FPGA	Field-Programmable Gate Array
LED	light-emitting diode
MLE	Machine Learning Engine
SDHC	Secure Digital High Capacity
SDXC	Secure Digital eXtended Capacity
SPI	Serial Peripheral Interface
VIP	Video Interface Platform
USB	Universal Serial Bus
NN	Neuro Network
OPN	Ordering Part Number

1. Introduction

This user's guide provides a description of Lattice's Coordinate Rotation Digital Computer (CORDIC) IP core. The CORDIC IP core is configurable and supports several functions, including rotation, translation, sin and cos, and arctan. Two architecture configurations are supported for the arithmetic unit: parallel, in which the output data is calculated in a single clock cycle, and word-serial, in which the output data is calculated over multiple clock cycles. The input and output data widths and computation iterative numbers are configurable over a wide range of values. The IP core uses full precision arithmetic internally while supporting variable output precision and several choices of rounding algorithms.

2. Quick Facts

Table 2.1 through Table 2.10 give quick facts about the CORDIC IP core for LatticeECP™, LatticeECP2™, LatticeECP2M™, LatticeECP3™, LatticeSC/M™, LatticeXP™, LatticeXP2™, ECP5™ (LFE5U), ECP5™ (LFE5UM), and ECP5-5G™ (LFE5UM5G) devices, respectively.

Table 2.1. Cordic IP Core for LatticeECP Devices Quick Facts

		Cordic IP Configuration			
		Rotate Parallel	Translate Parallel	Rotate Serial	Translate Serial
Core Requirements	FPGA Families Supported	LatticeECP			
	Minimal Device Needed	LFEC1E-3T100C	LFEC1E-3T100C	LFEC1E-3T100C	LFEC1E-3T100C
Resource Utilization	Targeted Device	LFEC20E-5F484C	LFEC20E-5F484C	LFEC20E-5F484C	LFEC20E-5F484C
	Data Path Width	16	16	16	16
	LUTs	1346	1332	685	730
	sysMEM EBRs	0	0	0	0
	Registers	1242	1218	315	358
Design Tool Support	Lattice Implementation	Lattice Diamond® 3.10.2.115			
	Synthesis	Synplify Pro® M-2017.03L-SP1-1			
	Simulation	Aldec® Active-HDL™ 10.3 Lattice Edition			

Table 2.2. CORDIC IP Core for LatticeECP2 Devices Quick Facts

		Cordic IP Configuration			
		Rotate Parallel	Translate Parallel	Rotate Serial	Translate Serial
Core Requirements	FPGA Families Supported	LatticeECP2			
	Minimal Device Needed	LFE2-6E-5T144C	LFE2-6E-5T144C	LFE2-6E-5T144C	LFE2-6E-5T144C
Resource Utilization	Targeted Device	LFE2-20E-7F484C	LFE2-20E-7F484C	LFE2-20E-7F484C	LFE2-20E-7F484C
	Data Path Width	16	16	16	16
	LUTs	1434	1420	693	730
	sysMEM EBRs	0	0	0	0
	Registers	1242	1214	315	357
Design Tool Support	Lattice Implementation	Lattice Diamond 3.10.2.115			
	Synthesis	Synplify Pro M-2017.03L-SP1-1			
	Simulation	Aldec Active-HDL 10.3 Lattice Edition			

Table 2.3. CORDIC IP Core for LatticeECP2M Devices Quick Facts

		Cordic IP Configuration			
		Rotate Parallel	Translate Parallel	Rotate Serial	Translate Serial
Core Requirements	FPGA Families Supported	LatticeECP2M			
	Minimal Device Needed	LFE2M20E-5F256C	LFE2M20E-5F256C	LFE2M20E-5F256C	LFE2M20E-5F256C
Resource Utilization	Targeted Device	LFE2M20E-7F484C	LFE2M20E-7F484C	LFE2M20E-7F484C	LFE2M20E-7F484C
	Data Path Width	16	16	16	16
	LUTs	1434	1420	693	730
	sysMEM EBRs	0	0	0	0
	Registers	1242	1214	315	357
Design Tool Support	Lattice Implementation	Lattice Diamond 3.10.2.115			
	Synthesis	Synplify Pro M-2017.03L-SP1-1			
	Simulation	Aldec Active-HDL 10.3 Lattice Edition			

Table 2.4. CORDIC IP Core for LatticeECP3 Devices Quick Facts

		Cordic IP Configuration			
		Rotate Parallel	Translate Parallel	Rotate Serial	Translate Serial
Core Requirements	FPGA Families Supported	LatticeECP3			
	Minimal Device Needed	LFE3-17EA-6FTN256CES	LFE3-17EA-6FTN256CES	LFE3-17EA-6FTN256CES	LFE3-17EA-6FTN256CES
Resource Utilization	Targeted Device	LFE3-70E-8FN484C	LFE3-70E-8FN484C	LFE3-70E-8FN484C	LFE3-70E-8FN484C
	Data Path Width	16	16	16	16
	LUTs	1434	1420	693	730
	sysMEM EBRs	0	0	0	0
	Registers	1242	1214	315	357
Design Tool Support	Lattice Implementation	Lattice Diamond 3.10.2.115			
	Synthesis	Synplify Pro M-2017.03L-SP1-1			
	Simulation	Aldec Active-HDL 10.3 Lattice Edition			

Table 2.5. CORDIC IP Core for LatticeSC/M Devices Quick Facts

		Cordic IP Configuration			
		Rotate Parallel	Translate Parallel	Rotate Serial	Translate Serial
Core Requirements	FPGA Families Supported	LatticeSC/M			
	Minimal Device Needed	LFSC3GA15 E-5F256C	LFSC3GA15 E-5F256C	LFSC3GA15 E-5F256C	LFSC3GA15 E-5F256C
Resource Utilization	Targeted Device	LFSC3GA25 E-7F900C	LFSC3GA25 E-7F900C	LFSC3GA25 E-7F900C	LFSC3GA25 E-7F900C
	Data Path Width	16	16	16	16
	LUTs	1775	1984	743	793
	sysMEM EBRs	0	0	0	0
	Registers	1265	1257	329	363
Design Tool Support	Lattice Implementation	Lattice Diamond 3.10.2.115			
	Synthesis	Synplify Pro M-2017.03L-SP1-1			
	Simulation	Aldec Active-HDL 10.3 Lattice Edition			

Table 2.6. CORDIC IP Core for LatticeXP Devices Quick Facts

		Cordic IP Configuration			
		Rotate Parallel	Translate Parallel	Rotate Serial	Translate Serial
Core Requirements	FPGA Families Supported	LatticeXP			
	Minimal Device Needed	LFXP3C- 3Q208C	LFXP3C- 3Q208C	LFXP3C- 3Q208C	LFXP3C- 3Q208C
Resource Utilization	Targeted Device	LFXP20E- 5F484C	LFXP20E- 5F484C	LFXP20E- 5F484C	LFXP20E- 5F484C
	Data Path Width	16	16	16	16
	LUTs	1345	1331	692	731
	sysMEM EBRs	0	0	0	0
	Registers	1239	1216	320	355
Design Tool Support	Lattice Implementation	Lattice Diamond 3.10.2.115			
	Synthesis	Synplify Pro M-2017.03L-SP1-1			
	Simulation	Aldec Active-HDL 10.3 Lattice Edition			

Table 2.7. CORDIC IP Core for LatticeXP2 Devices Quick Facts

		Cordic IP Configuration			
		Rotate Parallel	Translate Parallel	Rotate Serial	Translate Serial
Core Requirements	FPGA Families Supported	LatticeXP2			
	Minimal Device Needed	LFXP2-5E-5M132C	LFXP2-5E-5M132C	LFXP2-5E-5M132C	LFXP2-5E-5M132C
Resource Utilization	Targeted Device	LFXP2-30E-7F484C	LFXP2-30E-7F484C	LFXP2-30E-7F484C	LFXP2-30E-7F484C
	Data Path Width	16	16	16	16
	LUTs	1426	1412	685	722
	sysMEM EBRs	0	0	0	0
	Registers	1240	1212	313	355
Design Tool Support	Lattice Implementation	Lattice Diamond 3.10.2.115			
	Synthesis	Synplify Pro M-2017.03L-SP1-1			
	Simulation	Aldec Active-HDL 10.3 Lattice Edition			

Table 2.8. CORDIC IP Core for ECP5 (LFE5U) Devices Quick Facts

		Cordic IP Configuration			
		Rotate Parallel	Translate Parallel	Rotate Serial	Translate Serial
Core Requirements	FPGA Families Supported	ECP5 (LFE5U)			
	Minimal Device Needed	LFE5U-12F-6BG256C	LFE5U-12F-6BG256C	LFE5U-12F-6BG256C	LFE5U-12F-6BG256C
Resource Utilization	Targeted Device	LFE5U-85F-8BG756C	LFE5U-85F-8BG756C	LFE5U-85F-8BG756C	LFE5U-85F-8BG756C
	Data Path Width	16	16	16	16
	LUTs	1423	1408	686	705
	sysMEM EBRs	0	0	0	0
	Registers	1239	1212	313	355
Design Tool Support	Lattice Implementation	Lattice Diamond 3.10.2.115			
	Synthesis	Synplify Pro M-2017.03L-SP1-1			
	Simulation	Aldec Active-HDL 10.3 Lattice Edition			

Table 2.9. CORDIC IP Core for ECP5 (LFE5UM) Devices Quick Facts

		CORDIC IP Configuration			
		Rotate Parallel	Translate Parallel	Rotate Serial	Translate Serial
Core Requirements	FPGA Families Supported	ECP5 (LFE5UM)			
	Minimal Device Needed	LFE5UM-25F-6BG381C	LFE5UM-25F-6BG381C	LFE5UM-25F-6BG381C	LFE5UM-25F-6BG381C
Resource Utilization	Targeted Device	LFE5UM-85F-8BG756C	LFE5UM-85F-8BG756C	LFE5UM-85F-8BG756C	LFE5UM-85F-8BG756C
	Data Path Width	16	16	16	16
	LUTs	1423	1408	685	699
	sysMEM EBRs	0	0	0	0
	Registers	1239	1212	315	357
Design Tool Support	Lattice Implementation	Lattice Diamond 3.10.2.115			
	Synthesis	Synplify Pro M-2017.03L-SP1-1			
	Simulation	Aldec Active-HDL 10.3 Lattice Edition			

Table 2.10. CORDIC IP Core for ECP5-5G (LFE5UM5G) Devices Quick Facts

		CORDIC IP Configuration			
		Rotate Parallel	Translate Parallel	Rotate Serial	Translate Serial
Core Requirements	FPGA Families Supported	ECP5-5G (LFE5UM5G)			
	Minimal Device Needed	LFE5UM5G-25F-8MG285C	LFE5UM5G-25F-8MG285C	LFE5UM5G-25F-8MG285C	LFE5UM5G-25F-8MG285C
Resource Utilization	Targeted Device	LFE5UM5G-85F-8BG756C	LFE5UM5G-85F-8BG756C	LFE5UM5G-85F-8BG756C	LFE5UM5G-85F-8BG756C
	Data Path Width	16	16	16	16
	LUTs	1423	1408	686	705
	sysMEM EBRs	0	0	0	0
	Registers	1239	1212	313	355
Design Tool Support	Lattice Implementation	Lattice Diamond 3.10.2.115			
	Synthesis	Synplify Pro M-2017.03L-SP1-1			
	Simulation	Aldec Active-HDL 10.3 Lattice Edition			

3. Features

- Functions supported:
 - Vector rotation (polar to rectangular)
 - Vector translation (rectangular to polar)
 - Sin and cos
 - Arctan
- Input data widths from 8 to 32 bits
- Configurable number of iterations used to derive output from 4 to 32
- Optional pre-rotation module
- Optional amplitude compensation scaling module to compensate for the CORDIC algorithm's output amplitude scale factor
- Selectable rounding algorithm: truncation, rounding up, rounding away from zero, convergent rounding
- Selectable parallel architectural configuration for throughput optimization
- Selectable word-serial architectural configuration for area optimization
- Signed 2's complement data
- Optional clock enable (ce) and synchronous reset (sr) control signals
- Full precision internal arithmetic

4. Functional Description

This chapter provides a functional description of the CORDIC IP core.

4.1. General Description of the CORDIC Algorithm

The CORDIC algorithm is an iterative method that uses simple arithmetic operations such as addition, subtraction, bit shift and table look up to perform hyperbolic and trigonometric functions. The CORDIC algorithm was initially designed to perform a vector rotation, where the vector (x, y) is rotated through the angle θ yielding a new vector (x', y') . Using a matrix form, a planar rotation for a vector of (x, y) is defined as:

$$\begin{aligned} x' &= x \cos \theta - y \sin \theta \\ y' &= y \cos \theta + x \sin \theta \end{aligned} \quad (1)$$

Note that θ is the angle that is to be traversed. With the CORDIC algorithm, the traversal is accomplished in iterative steps in which each step completes a small part of the rotation.

A single step is defined by the following equation:

$$\begin{aligned} x_{i+1} &= \cos \theta_i (x_i - y_i \tan \theta_i) \\ y_{i+1} &= \cos \theta_i (y_i + x_i \tan \theta_i) \end{aligned} \quad (2)$$

The number of multipliers required is reduced by selecting the angle steps such that the tangent of a step is a power of 2. The angle for each step is given by:

$$\theta_i = \arctan(1/2^i) \quad (3)$$

Multiplying or dividing by a power of 2 can be implemented using a simple shift operation. All iteration-angles summed must equal the rotation angle θ .

$$\sum_{i=0}^{\infty} d_i \theta_i = \theta \quad \text{where } d_i = \{-1; +1\} \quad (4)$$

This results in the following equation for $\tan \theta_i$:

$$\tan \theta_i = d_i 2^{-i} \quad (5)$$

Combining equations 2 and 5 results in:

$$\begin{aligned} x_{i+1} &= \cos \theta_i (x_i - y_i \cdot d_i \cdot 2^{-i}) \\ y_{i+1} &= \cos \theta_i (y_i + x_i \cdot d_i \cdot 2^{-i}) \end{aligned} \quad (6)$$

The iterative rotation can now be expressed as:

$$\begin{aligned}x_{i+1} &= K_i(x_i - y_i \cdot d_i \cdot 2^{-i}) \\y_{i+1} &= K_i(y_i + x_i \cdot d_i \cdot 2^{-i})\end{aligned}\tag{7}$$

where:

$$K_i = \cos(\tan^{-1} 2^{-i}) = 1/\sqrt{1+2^{-2i}}$$

$$d_i = \pm 1$$

The CORDIC rotator is normally operated in one of two modes. The first, called rotation, rotates the input vector by a specified angle. The second mode, called vectoring, rotates the input vector to the x-axis while recording the angle required to make that rotation.

For rotation mode, the CORDIC equations are:

$$\begin{aligned}x_{i+1} &= x_i - y_i \cdot d_i \cdot 2^{-i} \\y_{i+1} &= y_i + x_i \cdot d_i \cdot 2^{-i} \\z_{i+1} &= z_i - d_i \cdot \tan^{-1}(2^{-i})\end{aligned}\tag{8}$$

where $d_i = -1$ if $z_i < 0$, $+1$ otherwise. Here z_i is the residual angle in the angle accumulator with the initial value z_0 as the angle to be rotated.

In vectoring mode, the CORDIC vectoring function works by seeking to minimize the y component of the residual vector at each rotation. The sign of the residual component is used to determine which direction to rotate next. If the angle accumulator is initialized with zero, it will contain the traversed angle at the end of the iterations. For vectoring mode, the CORDIC equations are:

$$\begin{aligned}x_{i+1} &= x_i - y_i \cdot d_i \cdot 2^{-i} \\y_{i+1} &= y_i + x_i \cdot d_i \cdot 2^{-i} \\z_{i+1} &= z_i - d_i \cdot \tan^{-1}(2^{-i})\end{aligned}\tag{9}$$

where $d_i = -1$ if $y_i < 0$, $+1$ otherwise

In sin/cos mode, the unit vector is rotated by the input phase angle θ generating the output vector $(\cos(\theta), \sin(\theta))$. The rotation mode CORDIC operation can simultaneously compute the sine and cosine of the input angle θ . Setting the x component to 1 and y component to zero reduces the rotation mode. This results the equations 11 from equations 1:

$$\begin{aligned}x' &= \cos \theta \\y' &= \sin \theta\end{aligned}\tag{10}$$

In arctangent mode, $\theta = \arctan(y_0/x_0)$ is directly computed using the vectoring mode if the angle accumulator is initialized with zero.

$$z_n = z_0 + \arctan(y_0/x_0)\tag{11}$$

4.2. Block Diagram

Figure 4.1 shows a block diagram of the CORDIC IP Core.

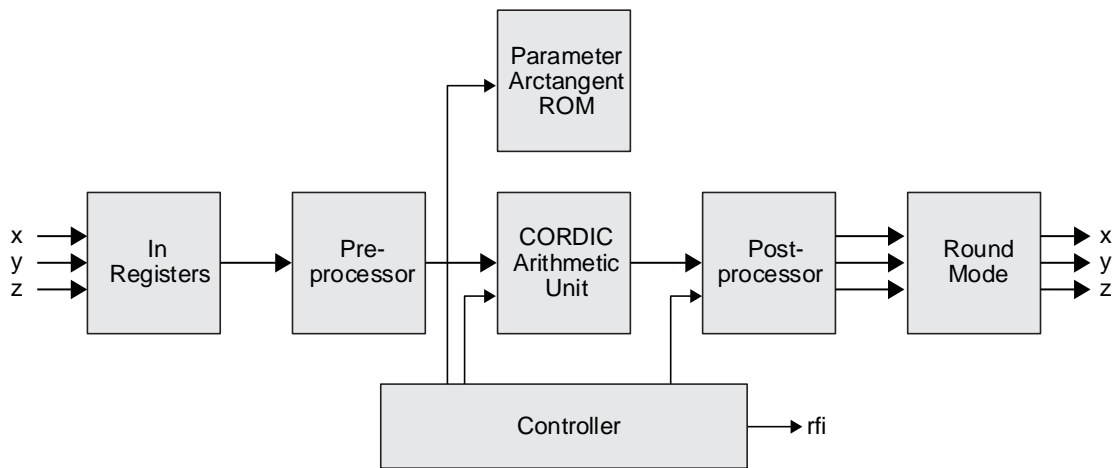

Figure 4.1. CORDIC IP Core Block Diagram

4.2.1. Data Path

4.2.1.1. Pre-processor

The CORDIC rotation and vectoring algorithms are limited to rotation angles between $-\pi/2$ and $\pi/2$. This limitation is due to the use of 2° for the tangent in the first iteration. For composite rotation angles larger than $\pi/2$, an additional rotation is required.

4.2.1.2. CORDIC Arithmetic Unit

The CORDIC arithmetic unit performs the actual CORDIC algorithm. Two architecture configurations are available for the arithmetic unit: parallel (with single-cycle data throughput) and word-serial (with multiple-cycle throughput). The parallel configuration has a pipeline-structured core and can perform a CORDIC transformation each clock cycle, producing a new output every cycle. In contrast with the parallel structure, word-serial architecture produces a new output every N cycles. Here N is the user input in the IPexpress™ interface for the Iteration Number parameter.

4.2.1.3. Arctan ROM

The arc tangent ROM stores the $\tan^{-1}(2^{-i})$ values. Its data width is variable, address width is $\log_2(\text{number of iterations}-1)$, address depth is $2^{\log_2(\text{number of iterations}-1)}$.

4.2.1.4. Controller

The controller module control generates all signals necessary for carrying out the iterations, including ROM addressing, ready for input (rfi) and output valid (outvalid). I/O port definition details are explained in Table 4.5.

4.2.1.5. Post-processor

The CORDIC algorithm introduces a scale factor that causes a magnitude gain that must be compensated for at the end (see Equation 8 in General Description of the CORDIC Algorithm). The post-processor module contains logic to correct the scale factor. In addition, it corrects the phase rotation introduced by the pre-processor module (if present).

4.2.1.6. Rounding

The rounding module provides four types of rounding, depending on the ROUNDING parameter:

- **None (truncation)** – Discards all bits to the right of the output least significant bit and leaves the output uncorrected.
- **Rounding up** – Rounds up if the fractional part is exactly one-half.
- **Rounding away from zero** – Rounds away from zero if the fractional part is exactly one-half.
- **Convergent rounding** – Rounds to the nearest even value if the fractional part is exactly one-half.

4.2.2. CORDIC Functions

4.2.2.1. Vector Rotation

Polar to Rectangular Translation: In vector rotation mode, the input vector (x, y) is rotated by a specified angle, θ , giving the a new output vector, (x', y') . Because of the CORDIC algorithm scale factor, a magnitude gain is introduced as shown in [Figure 4.2](#). This magnitude gain is compensated for by the CORDIC IP post-processor module.

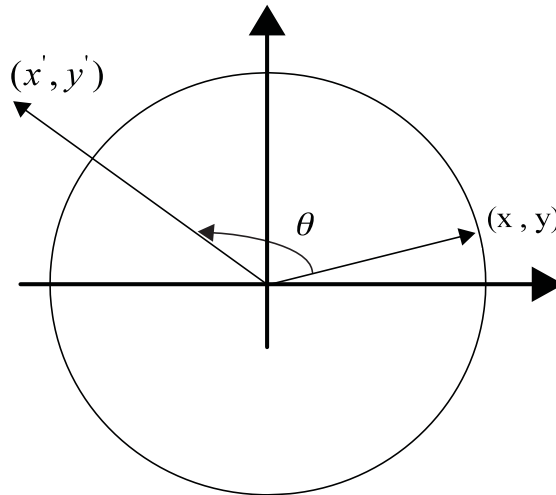

Figure 4.2. Vector Rotation

The inputs, x_{in} , y_{in} and $phase_{in}$, are limited to the ranges given in [Table 4.1](#). Inputs outside the ranges will produce unpredictable results.

Table 4.1. Vector Rotation Input/Output

Signal	Description
x_{in}	Input X Coordinate Range: $-1 \leq x_{in} \leq 1$
y_{in}	Input Y Coordinate Range: $-1 \leq y_{in} \leq 1$
$phase_{in}$	Input Rotation Angle Range: $-\pi \leq Phase_{in} \leq \pi$
x_{out}	Output X Coordinate Range: $-\sqrt{2} \leq x_{out} \leq \sqrt{2}$
y_{out}	Output Y Coordinate Range: $-\sqrt{2} \leq y_{out} \leq \sqrt{2}$

4.2.2.2. Vector Translation

Rectangular to Polar Translation: In vector translation mode, the input vector (x, y) is rotated through whatever angle is necessary to align the result vector with the x-axis, as shown in Figure 2-3. Output is the angle rotated and the magnitude on the x-axis after rotation.

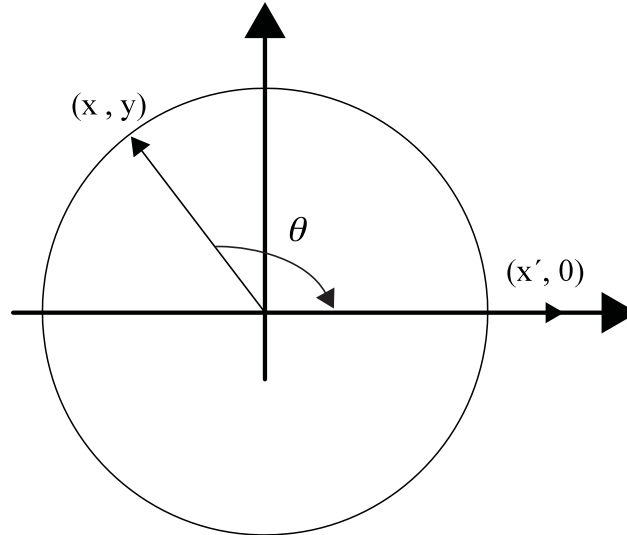

Figure 4.3. Vector Translation

The inputs, x_{in} and y_{in} , are limited to the ranges given in Table 4.2. Inputs outside the ranges will produce unpredictable results.

Table 4.2. Vector Translation Input/Output

Signal	Description
x_{in}	Input X Coordinate Range: $-1 \leq x_{in} \leq 1$
y_{in}	Input Y Coordinate Range: $-1 \leq y_{in} \leq 1$
x_{out}	Output Magnitude Range: $-\sqrt{2} \leq x_{out} \leq \sqrt{2}$
phaseout	Output Phase Range: $-\pi \leq \text{Phaseout} \leq \pi$

4.2.2.3. Sin and Cos

In sin/cos mode, the unit vector is rotated by the input phase angle θ providing the output vector $(\cos(\theta), \sin(\theta))$. The input angle, phase_{in} , is limited to the range given in Table 4.3. Inputs outside this range will produce unpredictable results.

Table 4.3. Sin and Cos Input/Output

Signal	Description
phasein	Input Phase Range: $-\pi \leq \text{Phasein} \leq \pi$
x_{out}	Output $\cos(\theta)$ Range: $-1 \leq x_{out} \leq 1$
y_{out}	Output $\sin(\theta)$ Range: $-1 \leq y_{out} \leq 1$

4.2.2.4. Arctan

In arctan mode, the input vector, (x, y) is rotated until the y component is zero, yielding the output angle, (y/x) . The inputs x_{in} and y_{in} are limited to the ranges given in Table 4.4. Inputs outside the ranges will produce unpredictable results.

Table 4.4. Arctan Input/Output

Signal	Description
x_{in}	Input X Coordinate Range: $-1 \leq x_{in} \leq 1$
y_{in}	Input Y Coordinate Range: $-1 \leq y_{in} \leq 1$
phaseout	Output Phase Range: $-\pi \leq \text{Phaseout} \leq \pi$

4.3. Interface Diagram

The top-level interface diagram for the CORDIC IP core is shown in Figure 4.4. The description of the Input/Output (I/O) ports for the CORDIC IP core is provided in Table 4.5.

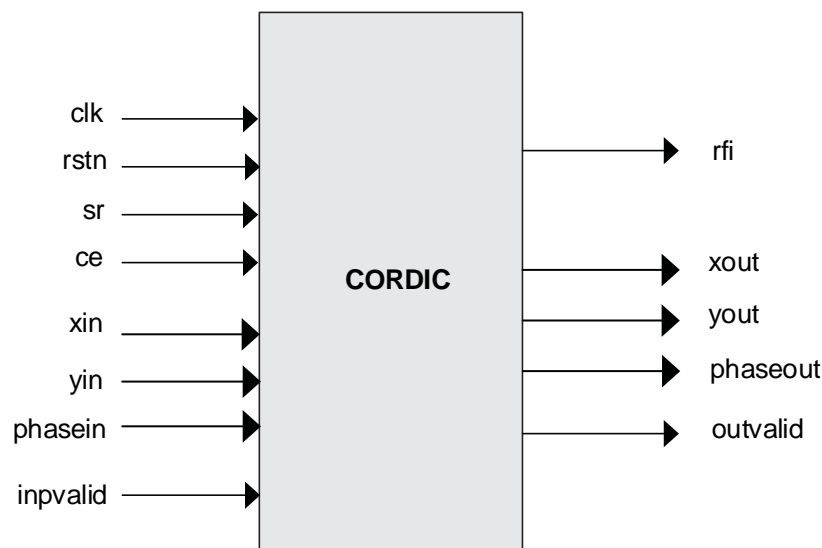

Figure 4.4. Top-Level Interface for CORDIC IP Core

Table 4.5. Top-Level Definitions

Port	Bits	I/O	Description
General I/Os			
clk	1	I	System clock for data and control inputs and outputs.
rstn	1	I	System-wide asynchronous active-low reset signal.
x_{in}	DINWIDTH	I	X component of input sample
y_{in}	DINWIDTH	I	Y component of input sample
phasein	DINWIDTH	I	Phase component of input sample
inpvalid	1	I	Input valid signal. The input data is read in only when inpvalid is high.
xout	DOUTWIDTH	O	X component of output sample
yout	DOUTWIDTH	O	Y component of output sample
phaseout	DOUTWIDTH	O	Y component of output sample

Port	Bits	I/O	Description
outvalid	1	O	Output data qualifier. Output data is valid only when this signal is high.
rfi	1	O	Ready for input. This output, when high, indicates that the IP core is ready to receive the next input data. A valid data may be applied at xin, yin and phasein only if rfi was high during the previous clock cycle.
Optional I/Os			
ce	1	I	Clock Enable. Independent.
sr	1	I	Synchronous Reset. Independent.

4.4. Configuring the CORDIC IP Core

4.4.1. Basic Options

The options for mode, architecture, number of iterations and compensation are independent and specified in the Basic Options tab of the interface. Refer to [Basic Options Tab](#) for more details.

4.4.1.1. Architecture Specification

The CORDIC IP core provides two architecture configurations for the arithmetic unit: parallel (with single cycle data throughput) and word-serial (with multiple-cycle throughput). Because of the pipelined structure, the core can perform a CORDIC transformation each clock cycle, thus producing a new output every cycle. In contrast with parallel structures, word-serial architecture produces a new output every N cycles. [Figure 4.5](#) shows a basic CORDIC arithmetic unit.

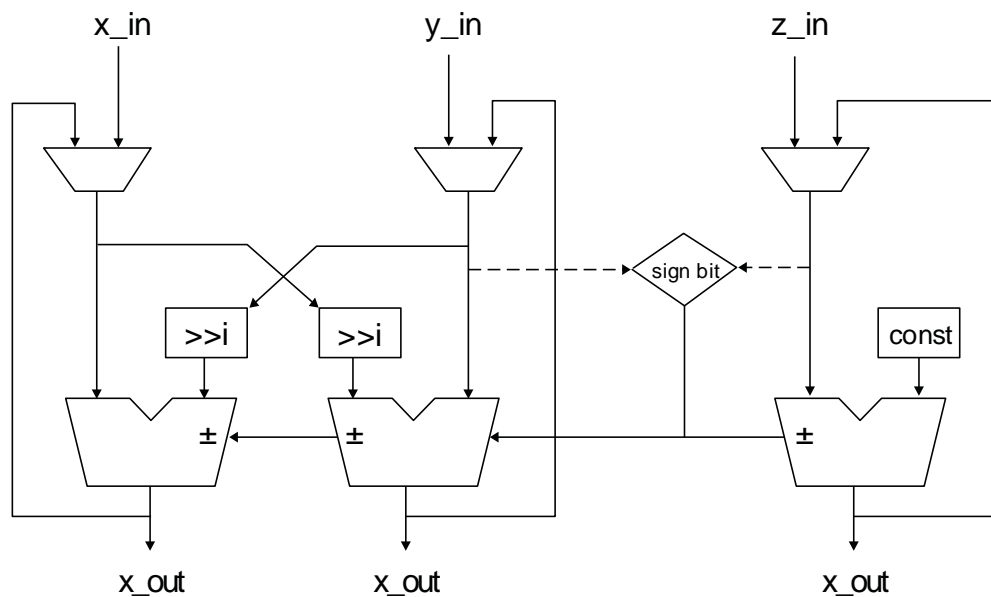

Figure 4.5. Basic CORDIC Arithmetic Unit

4.4.1.2. Iterations Specification

Parameter iteration specifies the number of internal add-sub iterations performed by the CORDIC processor in deriving the result. It determines the accuracy of the output: if the number is larger, the accuracy of the output is higher.

4.4.1.3. Pre-rotation Specification

When the pre-rotation module is selected, the CORDIC operational range extends to the full circle; otherwise the operational range is limited between $-\pi/2$ and $\pi/2$. Angle ranges outside the ranges will produce an unpredictable result if the pre-rotation module is not selected. The following describes an initial pre-rotation $\pm\pi/2$:

$$\begin{aligned} x' &= -d \cdot y \\ y' &= d \cdot x \\ z' &= z + d \cdot \pi/2 \end{aligned} \tag{12}$$

4.4.1.4. Compensation Specification

In the CORDIC algorithm, the magnitude outputs, xout and yout, are generated with a magnitude gain. The compensation module provides three configurations to compensate for the CORDIC magnitude scale factor.

- **None** – The outputs xout and yout will not be compensated. It is the user’s obligation to compensate and scale for the magnitude outputs gain introduced by the CORDIC algorithm. Refer to [General Description of the CORDIC Algorithm](#) of this document for details, especially the K factor in Equation.
- **LUT-based** – The outputs xout and yout are compensated using a LUT-based multiplier.
- **DSP-based** – The outputs xout and yout are compensated using a DSP-based multiplier.

4.4.2. Advanced Options

The controls in this tab are used to define the various data widths and rounding methods used in the data path. The widths of the input data and output data can be defined independently.

4.4.2.1. Round Method Specification

The CORDIC IP core provides four rounding modes. Examples of round method are given in [Table 4.6](#).

- **Truncation** – The outputs, xout, yout and phaseout, are truncated. The LSBs are removed to match the specified output width.
- **Rounding up** – The outputs, xout, yout and phaseout, are rounded up (0.5 rounded up).
- **Rounding away from zero** – The outputs, xout, yout and phaseout, are rounded (0.5 rounded up, -0.5 rounded down).
- **Convergent rounding** – The outputs, xout, yout and phaseout, are rounded towards the nearest even number.

Table 4.6. Round Method

	Truncation	Rounding Up	Rounding Away from Zero	Converting Rounding
1.50	1	2	2	2
-1.50	-2	-1	-2	-2
0.50	0	1	1	0
-0.50	-1	0	-1	0
0.25	0	0	0	0
-0.25	-1	0	0	0
0.65	0	1	1	0

4.4.2.2. Input/Output Width Specification

The input/output data widths can be configured in the range 8 to 32 bits.

4.4.2.3. Data Format Specification

The data signals are: xin, yin, xout and yout. The input data signals, xin and yin, must be in the range [-1,1]. Input data outside the range will produce unpredictable results.

- **Input Data Signals**

Input data signals are represented in decimal format using bus format (as little endian). For N-bit input data signal, the (N-2) LSB represent the fractional component to the left of the decimal place and the MSB represents the sign bit.

For example, when the DINWIDTH is 8, +1 and -1 are represented as:

01000000 => 01.000000 => +1.0

11000000 => 11.000000 => -1.0

When the DINWIDTH is 12, +1 and -1 are represented as:

010000000000 => 01.0000000000 => +1.0

110000000000 => 11.0000000000 => -1.0

- **Output Data Signals**

If compensation is LUT- based or DSP-based, the output data signal format is the same as the input data signal format. The range of the output data signal is $[-\sqrt{2}, \sqrt{2}]$.

For N-bit output data signal, the (N-2) LSB represent the fractional component to the left of the decimal place and the MSB represents the sign bit.

For example, when the DOUTWIDTH is 8, in the data format, +1 and -1 are represented:

01000000 => 01.000000 => +1.0

11000000 => 11.000000 => -1.0

When the DOUTWIDTH is 12, in the data format, +1 and -1 are represented:

010000000000 => 01.0000000000 => +1.0

110000000000 => 11.0000000000 => -1.0

If compensation is None, the output data signals format is different from the input data signals. Due to the magnitude gain introduced by the CORDIC algorithm, without the compensation, the range of the output data signal can be larger than 2 or less than -2, so it will need 2 bits to represent the decimal number.

For the N-bit output data signal, the (N-3) LSB represent the fractional component to the left of the decimal place and the MSB represents the sign bit.

For example, when the DOUTWIDTH is 8, in the data format, +1 and -1 are represented:

00100000 => 001.00000 => +1.0

11000000 => 111.00000 => -1.0

When the DOUTWIDTH is 12, in the data format, +2 and -2 are represented:

010000000000 => 010.000000000 => +2.0

110000000000 => 110.000000000 => -2.0

+2.25 and -2.25 are represented:

010010000000 => 010.010000000 => +2.25

101110000000 => 101.110000000 => -2.25

4.4.2.4. Phase Format Specification

- **Phase Signals**

The phase signals are phasein and phaseout. The input phase signal, phasein, must be in the range $[-\frac{1}{4}, \frac{1}{4}]$. Input phase outside this range will produce unpredictable results.

The phase signals, phasein and phaseout, are always the same representation.

For N-bit phase signal, the (N-3) LSB represents the fractional component to the left of the decimal place and the MSB represents the sign bit.

For example, when the DINWIDTH is 10, in the data format, $+\frac{\pi}{4}$ and $-\frac{\pi}{4}$ are represented:

0110010010 => 011.0010010 => $+\pi$

1001101110 => 100.1101110 => $-\pi$

When the DINWIDTH is 13, in the data format, $+\frac{\pi}{4}$ and $-\frac{\pi}{4}$ are represented:

0110010010001 => 011.0010010001 => $+\pi$

1001101101111 => 100.1101101111 => $-\pi$

4.4.2.5. Synthesis Options Specification

There are two synthesis options for controlling IP generation flow, the Frequency constraint and Pipelining and retiming. The Pipelining and retiming option is used to move existing registers in order to balance the delays between registers. Users can adjust these two options to optimize for timing and area.

4.5. Timing Specification

Timing diagrams for the CORDIC IP core are given in the [Figure 4.6](#), [Figure 4.7](#), and [Figure 4.8](#).

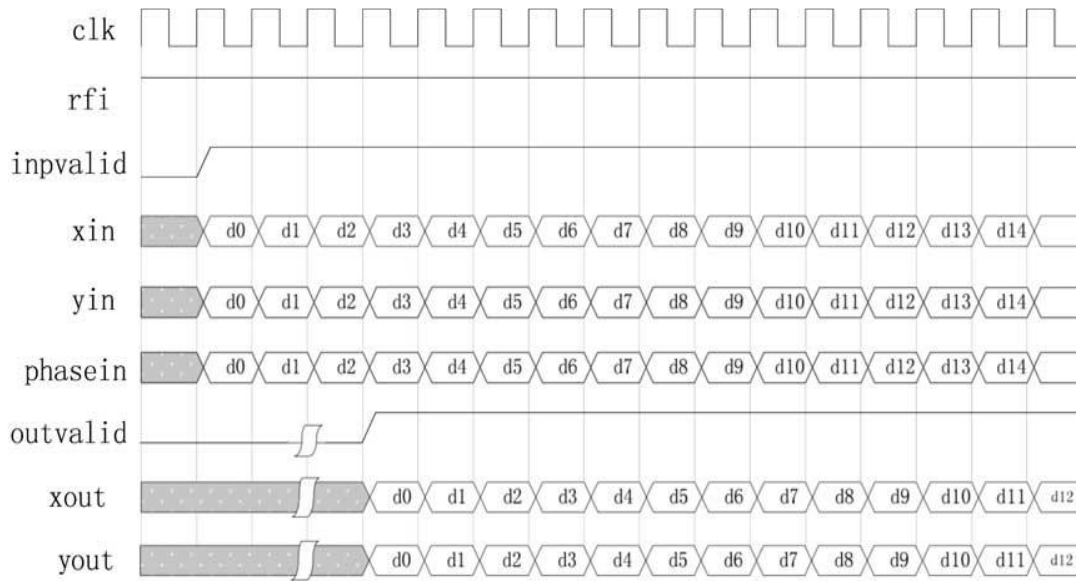

Figure 4.6. Timing Diagram for Parallel CORDIC (Rotation Mode) with Continuous Input



Figure 4.7. Timing Diagram for Parallel CORDIC (Sin/Cos Mode) with Gapped Inputs

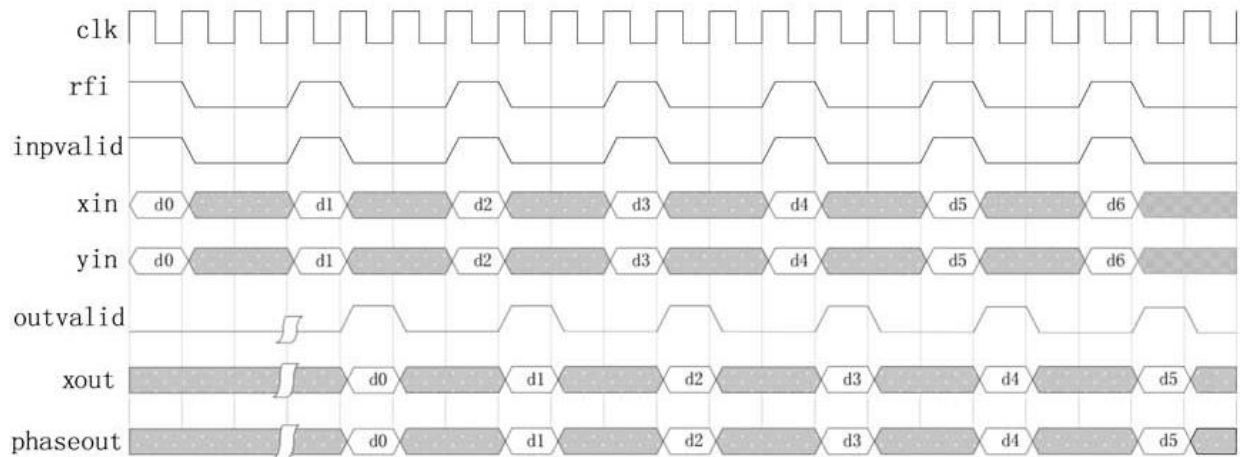

Figure 4.8. Timing Diagram for Serial CORDIC (Translation Mode)

5. Parameter Settings

The IPexpress™ tool is used to create IP and architectural modules in the Diamond and ispLEVER software. You may refer to the [IP Core Generation](#) section on how to generate the IP.

[Table 5.1](#) provides the list of user configurable parameters for the CORDIC IP core. The parameter settings are specified using the CORDIC IP core Configuration interface in IPexpress.

Table 5.1. Parameter Specifications for the CORDIC IP Core

Parameter	Range/Options	Default
CORDIC Specifications		
Mode	Rotate, Translate, Sin/Cos, Arctan	Rotate
Architecture	Word-Serial, Parallel	Parallel
Iterations	4 - 32	16
Compensation	None, LUT based, DSP based	None
Prerotation	Disable, Enable	Enable
I/O Specifications		
Input data width	8 - 32	16
Output data width	8 - 32	16
Precision Control		
Roundmethod	Truncation, Rounding up, Round away from zero, Convergent	Truncation
Option Ports		
Synchronous Reset	Disable, Enable	Disable
Clock Enable	Disable, Enable	Disable
Synthesis Options		
Frequency constraint	1- 400	250
Pipelining and retiming	Disable, Enable	Disable

5.1. Basic Options Tab

[Figure 5.1](#) shows the CORDIC Basic Options tab in the IPexpress tool.

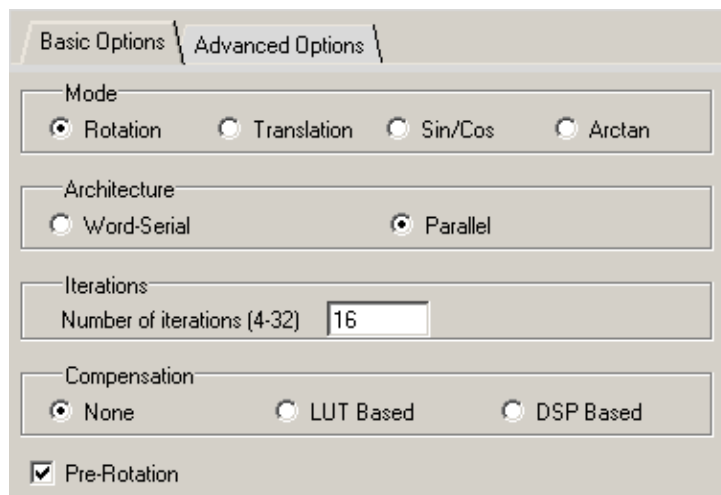

Figure 5.1. CORDIC Basic Options Tab

5.1.1. Mode

Specifies the CORDIC function to be performed.

5.1.2. Architecture

Specifies the architecture configuration for the CORDIC core: parallel (with single-cycle data throughput) or word serial (with multiple-cycle throughput).

5.1.3. Iterations

Specifies the number of internal add-sub iterations to perform.

5.1.4. Compensation

Specifies CORDIC magnitude scaling compensation. The outputs are compensated using a LUT-based multiplier or the block multiplier.

5.1.5. Pre-Rotation

Specifies whether the pre-rotation module is instantiated.

5.2. Advanced Options Tab

Figure 5.2 shows the contents of the I/O Specification tab.

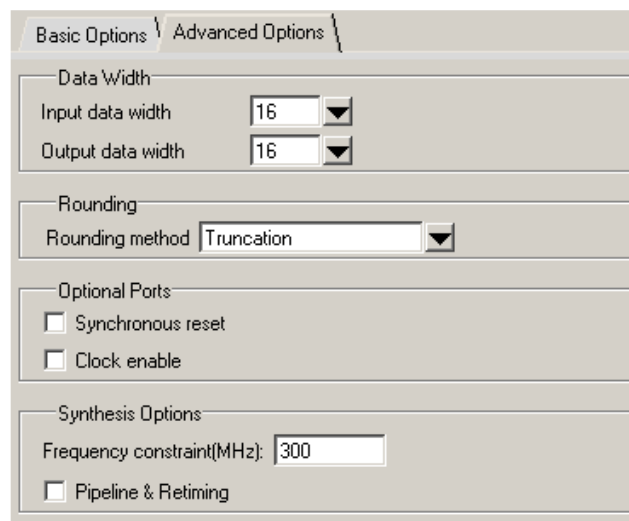

Figure 5.2. CORDIC Advanced Options Tab

5.2.1. Data Width

Consists of two dropdown menus: Input Data Width and Output Data Width.

5.2.2. Rounding

Identifies the rounding method to be used when it is necessary to drop one or more LSBs from the true output.

5.2.3. Optional Ports

5.2.3.1. Synchronous Reset

Specifies whether a synchronous reset port is needed. A synchronous reset signal resets all the registers in the IP core.

5.2.3.2. Clock Enable

Specifies whether a clock enable port is needed in the IP. Clock enable control can be used for power saving when the core is not used. Use of clock enable port increases the resource utilization and may affect performance due to increased routing congestion.

5.2.4. Synthesis Options

5.2.4.1. Frequency Constraints (MHz)

Specifies frequency constraint for synthesis and PAR. The value specified here will be included in the .lpf file with an additional 50MHz overconstraining adjustment factor (overconstraining typically provides improved performance). For example, if this value is 250, the frequency constraint in the .lpf file will be 250MHz PAR_ADJ 50.

5.2.4.2. Pipelining and Retiming

Specifies pipelining and retiming synthesis options for Synplify Pro. This option is not recommended to be selected.

6. IP Core Generation

This chapter provides information on how to generate the CORDIC IP core using the Diamond or ispLEVER soft-ware IPexpress tool, and how to include the core in a top-level design.

6.1. Licensing the IP Core

An IP core- and device-specific license is required to enable full, unrestricted use of the CORDIC IP core in a complete, top-level design. Instructions on how to obtain licenses for Lattice IP cores are given at:

<http://www.latticesemi.com/products/intellectualproperty/aboutip/ispilvercoreonlinepurchas.cfm>

Users may download and generate the CORDIC IP core and fully evaluate the core through functional simulation and implementation (synthesis, map, place and route) without an IP license. The CORDIC IP core also supports Lattice's IP hardware evaluation capability, which makes it possible to create versions of the IP core that operate in hardware for a limited time (approximately four hours) without requiring an IP license. See [Hardware Evaluation](#) for further details. However, a license is required to enable timing simulation, to open the design in the Diamond or ispLEVER EPIC tool, and to generate bitstreams that do not include the hardware evaluation timeout limitation.

6.2. Getting Started

The CORDIC IP core is available for download from the Lattice IP Server using the IPexpress tool. The IP files are automatically installed using ispUPDATE technology in any customer-specified directory. After the IP core has been installed, the IP core will be available in the IPexpress interface dialog box shown in [Figure 6.1](#).

The IPexpress tool interface dialog box for the CORDIC IP core is shown in [Figure 6.1](#). To generate a specific IP core configuration, the user specifies:

- **Project Path** – Path to the directory where the generated IP files will be located.
- **File Name** – Username designation given to the generated IP core and corresponding folders and files.
- **(Diamond) Module Output** – Verilog or VHDL.
- **(ispLEVER) Design Entry Type** – Verilog HDL or VHDL.
- **Device Family** – Device family to which IP is to be targeted (such as LatticeSCM, Lattice ECP2M, LatticeECP3, etc.). Only families that support the particular IP core are listed.
- **Part Name** – Specific targeted part within the selected device family.



Figure 6.1. IPexpress Dialog Box

Note that if the IPexpress tool is called from within an existing project, Project Path, Module Output (Design Entry in ispLEVER), Device Family, and Part Name default to the specified project parameters. Refer to the IPexpress tool online help for further information.

To create a custom configuration, the user clicks the **Customize** button in the IPexpress tool dialog box to display the CORDIC IP core Configuration interface, as shown in [Figure 6.2](#). From this dialog box, the user can select the IP parameter options specific to their application. Refer to [Parameter Settings](#) for more information on the CORDIC IP core parameter settings.



Figure 6.2. Configuration Interface (Diamond Version)

6.3. IPexpress-Created Files and Top Level Directory Structure

When the user clicks the **Generate** button in the IP Configuration dialog box, the IP core and supporting files are generated in the specified Project Path directory. The directory structure of the generated files is shown in Figure 6.3.



Figure 6.3. LatticeECP2M CORDIC IP Core Directory Structure

Table 6.1 provides a list of key files and directories created by the IPexpress tool and how they are used. The IPexpress tool creates several files that are used throughout the design cycle. The names of most of the created files are customized to the user's module name specified in the IPexpress tool.

Table 6.1. File List

File	Description
<username>_inst.v	This file provides an instance template for the IP.
<username>.v	This file provides a wrapper for the CORDIC core for simulation.
<username>_beh.v	This file provides a behavioral simulation model for the CORDIC core.
cordic_params.v	This file provides parameters necessary for the simulation.
<username>_bb.v	This file provides the synthesis black box for the user's synthesis.
<username>.ngo	The ngo files provide the synthesized IP core.
<username>.lpc	This file contains the IPexpress tool options used to recreate or modify the core in the IPexpress tool.
<username>.ipx	The IPX file holds references to all of the elements of an IP or Module after it is generated from the IPexpress tool (Diamond version only). The file is used to bring in the appropriate files during the design implementation and analysis. It is also used to re-load parameter settings into the IP/Module generation interface when an IP/Module is being re-generated.
<username>_top.[v,vhd]	This file provides a module which instantiates the CORDIC core. This file can be easily modified for the user's instance of the CORDIC core. This file is located in the <username>_eval/<username>_src/rtl/top/ directory.

These are all of the files necessary to implement and verify the CORDIC IP core in your own top-level design. The following additional files providing IP core generation status information are also generated in the Project Path directory:

- <username>_generate.log – Synthesis and map log file.
- <username>_gen.log – IPexpress IP generation log file.

The \<cordic_eval> and subtending directories provide files supporting the CORDIC IP core evaluation. The \<cordic_eval> directory contains files/folders with content that is constant for all configurations of the CORDIC IP core. The \<username> subfolder contains files/folders with content specific to the username configuration. The \<cordic_eval> directory is created by IPexpress the first time the core is generated and updated each time the core is regenerated. A \<username> directory is created by IPexpress each time the core is generated and regenerated each time the core with the same file name is regenerated. A separate \<username> directory is generated for cores with different names, such as \<my_core_0>, \<my_core_1>, etc.

6.4. Instantiating the Core

The generated CORDIC IP core package includes black-box (<username>_bb.v) and instance (<username>_inst.v) templates that can be used to instantiate the core in a top-level design. An example RTL top-level reference source file that can be used as an instantiation template for the IP core is provided in \<project_dir>\<cordic_eval>\<username>\src\rtl\top. Users may also use this top-level reference as the starting template for the top-level for their complete design.

6.5. Running Functional Simulation

Simulation support for the CORDIC IP core is provided for Aldec Active-HDL (Verilog and VHDL) simulator, Mentor Graphics ModelSim simulator. The functional simulation includes a configuration-specific behavioral model of the CORDIC IP core. The test bench sources stimulus to the core, and monitors output from the core. The generated IP core package includes the configuration-specific behavior model (<username>_beh.v) for functional simulation in the Project Path root directory. The simulation scripts supporting ModelSim evaluation simulation is provided in \<project_dir>\<cordic_eval>\<username>\sim\modelsim\scripts. The simulation script supporting Aldec evaluation simulation is provided in \<project_dir>\<cordic_eval>\<username>\sim\aldec\scripts. Both Modelsim and Aldec

simulation is supported via test bench files provided in `\<project_dir>\cordic_eval\testbench`. Models required for simulation are provided in the corresponding `\models` folder. Users may run the Aldec evaluation simulation by doing the following:

1. Open Active-HDL.
2. Under the Tools tab, select **Execute Macro**.
3. Browse to folder `\<project_dir>\cordic_eval\<username>\sim\aldec\scripts` and execute one of the **do** scripts shown.

To run the Modelsim evaluation simulation:

1. Open ModelSim.
2. Under the File tab, select Change Directory and choose the folder `<project_dir>\cordic_eval\<username>\sim\modelsim\scripts`.
3. Under the Tools tab, select **Execute Macro** and execute the ModelSim **do** script shown.

Note: When the simulation is complete, a pop-up window appears asking “**Are you sure you want to finish?**” Choose **No** to analyze the results. Choosing **Yes** closes ModelSim.

6.6. Synthesizing and Implementing the Core in a Top-Level Design

Synthesis support for the CORDIC IP core is provided for Mentor Graphics Precision or Synopsys Synplify. The CORDIC IP core itself is synthesized and is provided in NGO format when the core is generated in IPexpress. Users may synthesize the core in their own top-level design by instantiating the core in their top-level as described in IP Core Generation IPUG81_1.3, August 2012 28 CORDIC IP Core User’s Guide previously, and then synthesizing the entire design with either Synplify or Precision RTL Synthesis. The following text describes the evaluation implementation flow for Windows platforms. The flow for Linux and UNIX platforms is described in the Readme file included with the IP core. The top-level files `<username>_top.v` are provided in `\<project_dir>\cordic_eval\<username>\src\rtl\top`. Push-button implementation of the reference design is supported via Diamond or ispLEVER project files, `<username>.syn` for ispLEVER or `<username>.ldf` for Diamond, locates in the following directory:

`\<project_dir>\cordic_eval\<username>\impl\<synplify or precision>`.

To use this project file in Diamond:

1. Choose **File > Open > Project**.
2. Browse to `\<project_dir>\cordic_eval\<username>\impl\<synplify (or precision)>` in the Open Project dialog box.
3. Select and open `<username>_syn`. At this point, all of the files needed to support top-level synthesis and implementation will be imported to the project.
4. Select the Process tab in the left-hand interface window.
5. Implement the complete design through the standard Diamond interface flow.

To use this project file in ispLEVER:

1. Choose **File > Open Project**.
2. Browse to `\<project_dir>\cordic_eval\<username>\impl\<synplify (or precision)>` in the Open Project dialog box.
3. Select and open `<username>_syn`. At this point, all of the files needed to support top-level synthesis and implementation will be imported to the project.
4. Select the device top-level entry in the left-hand interface window.
5. Implement the complete design through the standard ispLEVER interface flow.

6.7. Hardware Evaluation

The CORDIC IP core supports Lattice's IP hardware evaluation capability, which makes it possible to create versions of the IP core that operate in hardware for a limited period of time (approximately four hours) without requiring the purchase of an IP license. It may also be used to evaluate the core in hardware in user-defined designs.

6.7.1. Enabling Hardware Evaluation in Diamond

Choose **Project > Active Strategy > Translate Design Settings**. The hardware evaluation capability may be enabled/disabled in the Strategy dialog box. It is enabled by default.

6.7.2. Enabling Hardware Evaluation in ispLEVER

In the Processes for Current Source pane, right-click the **Build Database** process and choose **Properties** from the dropdown menu. The hardware evaluation capability may be enabled/disabled in the Properties dialog box. It is enabled by default.

6.8. Updating/Regenerating the IP Core

By regenerating an IP core with the IPexpress tool, you can modify any of its settings including device type, design entry method, and any of the options specific to the IP core. Regenerating can be done to modify an existing IP core or to create a new but similar one.

6.8.1. Regenerating an IP Core in Diamond

To regenerate an IP core in Diamond:

1. In IPexpress, click the **Regenerate** button.
2. In the Regenerate view of IPexpress, choose the IPX source file of the module or IP you wish to regenerate.
3. IPexpress shows the current settings for the module or IP in the Source box. Make your new settings in the **Target** box.
4. If you want to generate a new set of files in a new location, set the new location in the **IPX Target File** box. The base of the file name will be the base of all the new file names. The IPX Target File must end with an .ipx extension.
5. Click **Regenerate**. The module's dialog box opens showing the current option settings.
6. In the module dialog box, choose the desired options.
For more information about the options, click **Help**. Also, check the About tab in IPexpress for links to technical notes and user guides. IP may come with additional information.
As the options change, the schematic diagram of the module changes to show the I/O and the device resources the module needs.
7. To import the module into your project, if it's not already there, select **Import IPX to Diamond Project** (not available in stand-alone mode).
8. Click **Generate**.
9. Check the Generate Log tab to check for warnings and error messages.
10. Click **Close**.

The IPexpress package file (.ipx) supported by Diamond holds references to all of the elements of the generated IP core required to support simulation, synthesis and implementation. The IP core may be included in a user's design by importing the .ipx file to the associated Diamond project. To change the option settings of a module or IP that is already in a design project, double-click the module's .ipx file in the File List view. This opens IPexpress and the module's dialog box showing the current option settings. Then go to step 6 above.

6.8.2. Regenerating an IP Core in ispLEVER

To regenerate an IP core in ispLEVER:

1. In the IPexpress tool, choose **Tools > Regenerate IP/Module**.
2. In the Select a Parameter File dialog box, choose the Lattice Parameter Configuration (.lpc) file of the IP core you wish to regenerate, and click **Open**.
3. The Select Target Core Version, Design Entry, and Device dialog box shows the current settings for the IP core in the Source Value box. Make your new settings in the Target Value box.
4. If you want to generate a new set of files in a new location, set the location in the LPC Target File box. The base of the .lpc file name will be the base of all the new file names. The LPC Target File must end with an .lpc extension.
5. Click **Next**. The IP core's dialog box opens showing the current option settings.
6. In the dialog box, choose desired options. To get information about the options, click **Help**. Also, check the About tab in the IPexpress tool for links to technical notes and user guides. The IP core might come with additional information. As the options change, the schematic diagram of the IP core changes to show the I/O and the device resources the IP core will need.
7. Click **Generate**.
8. Click the **Generate Log** tab to check for warnings and error messages.

7. Core Verification

The functionality of the Lattice CORDIC IP core has been verified via simulation and hardware testing, including a simulation environment verifying proper CORDIC functionality.

References

- J. E. Volder, "The CORDIC trigonometric computing technique." IRE Trans. Electron. Comput., vol. EC-8, no. 3, pp. 330-334, Sept. 1959.
- Andraka, Ray, "A survey of CORDIC algorithms for FPGA based computers." Proceedings of the 1998 ACM/SIGDA sixth international symposium on field programmable gate arrays, Feb. 22-24, 1998, Monterrey, CA. pp191-200.
- Duprat, J. and Muller, J.M., "The CORDIC Algorithm: New Results for Fast VLSI Implementation." IEEE Transactions on Computers, Vol. 42, pp. 168-178, 1993.
- Deprettere, E., Dewilde, P., and Udo, R, "Pipelined CORDIC Architecture for Fast VLSI Filtering and Array Processing." Proc. ICASSP'84, 1984, pp. 41.A.6.1-6.4.

LatticeEC/ECP

- [LatticeEC/ECP Family Handbook \(HB1000\)](#)

LatticeECP2M

- [LatticeECP2M Family Handbook \(HB1003\)](#)

LatticeECP3

- [LatticeECP3 Family Handbook \(HB1009\)](#)
- [LatticeECP3 Marvell 1 GbE \(1000BASE-X\) Physical/MAC Layer Interoperability \(TN1196\)](#)
- [LatticeECP3/Marvell SGMII Physical/MAC Layer Interoperability \(TN1197\)](#)

LatticeSCM

- [LatticeSC/M Family Data Sheet \(DS1004\)](#)
- [LatticeSC/M Family flexiPCS Data Sheet \(DS1005\)](#)

LatticeXP

- [LatticeXP Family Handbook \(HB1001\)](#)

LatticeXP2

- [LatticeXP2™ Family Data Sheet \(DS1009\)](#)

Technical Support Assistance

Submit a technical support case through www.latticesemi.com/techsupport.

Appendix A. Resource Utilization

This appendix provides resource utilization information for Lattice FPGAs using the CORDIC IP core.

IPexpress is the Lattice IP configuration utility, and is included as a standard feature of the Diamond and ispLEVER design tools. Details regarding the usage of IPexpress can be found in the IPexpress and Diamond or ispLEVER help system. For more information on the Diamond or ispLEVER design tools, visit the Lattice web site at: www.latticesemi.com/software. Table A.1 lists the parameter settings used in deriving the utilization data shown in Table A.2 through Table A.12.

Table A.1. Parameter Settings of the Evaluation Packages

	Config1	Config2	Config3	Config4
Mode	Rotate	Rotate	Translate	Sin and Cos
Input Data Width	16	16	16	16
Output Data Width	16	16	16	16
Number of Iteration	16	16	16	16
Architecture	Parallel	Serial	Parallel	Parallel
Compensation	No	No	No	No
Rounding Method	Truncation	Truncation	Truncation	Truncation
Pre-rotation	Yes	Yes	Yes	Yes
f _{MAX}	User specify	User specify	User specify	User specify
Retiming	No	No	No	No
Synchronous Reset	No	No	No	No
Clock Enable	No	No	No	No
Enable Hardware Evaluation	Yes	Yes	Yes	Yes

LatticeEC Devices

Table A.2. Performance and Resource Utilization (LatticeEC)*

User-Configurable Mode	Slices	LUTs	Registers	I/Os	sysMEM EBRs	MULT18X18	f _{MAX} (MHz)
1	704	1345	1239	85	0	0	184
2	359	692	320	85	0	0	111
3	711	1331	1216	69	0	0	163
4	611	1159	1078	53	0	0	185

***Note:** Performance and utilization data are generated targeting an LFEC20E-5F484C device using Lattice Diamond 3.10 and Synplify Pro M-2017.03L-SP1-1. Performance may vary when using a different software version or targeting a different device density or speed grade within the LatticeEC family.

Ordering Part Number

The Ordering Part Number (OPN) for the CORDIC targeting LatticeEC devices is CORDIC-E2-U1.

LatticeECP Devices

Table A.3. Performance and Resource Utilization (LatticeECP)*

User-Configurable Mode	Slices	LUTs	Registers	I/Os	sysMEM EBRs	MULT18X18	fMAX (MHz)
1	704	1346	1242	85	0	0	182
2	355	685	315	85	0	0	101
3	711	1332	1218	69	0	0	169
4	628	1197	1112	53	0	0	188

***Note:** Performance and utilization data are generated targeting an LFECP20E-5F484C device using Lattice Diamond 3.10 and Synplify Pro M-2017.03L-SP1-1. Performance may vary when using a different software version or targeting a different device density or speed grade within the LatticeECP family.

Ordering Part Number

The Ordering Part Number (OPN) for the CORDIC targeting LatticeECP devices is CORDIC-E2-U1.

LatticeECP2 Devices

Table A.4. Performance and Resource Utilization (LatticeECP2)*

User-Configurable Mode	Slices	LUTs	Registers	I/Os	sysMEM EBRs	MULT18X18	fMAX (MHz)
1	727	1434	1242	85	0	0	281
2	350	693	315	85	0	0	160
3	723	1420	1214	69	0	0	243
4	650	1281	1112	53	0	0	289

***Note:** Performance and utilization data are generated targeting an LFE2-20E-7F484C device using Lattice Diamond 3.10 Synplify Pro M-2017.03L-SP1-1. Performance may vary when using a different software version or targeting a different device density or speed grade within the LatticeECP2 family.

Ordering Part Number

The Ordering Part Number (OPN) for the CORDIC targeting LatticeECP2 devices is CORDIC-PM-U1.

LatticeECP2M Devices

Table A.5. Performance and Resource Utilization (LatticeECP2M)*

User-Configurable Mode	Slices	LUTs	Registers	I/Os	sysMEM EBRs	MULT18X18	fMAX (MHz)
1	727	1434	1242	85	0	0	243
2	350	693	315	85	0	0	154
3	723	1420	1214	69	0	0	283
4	650	1281	1112	53	0	0	273

***Note:** Performance and utilization data are generated targeting an LFE2M-20E-7F484C device using Lattice Diamond 3.10 and Synplify Pro M-2017.03L-SP1-1. Performance may vary when using a different software version or targeting a different device density or speed grade within the LatticeECP2M family.

Ordering Part Number

The Ordering Part Number (OPN) for the CORDIC targeting LatticeECP2M devices is CORDIC-PM-U1.

LatticeECP3 Devices

Table A.6. Performance and Resource Utilization (LatticeECP3)*

User-Configurable Mode	Slices	LUTs	Registers	I/Os	sysMEM EBRs	MULT18X18	fMAX (MHz)
1	721	1420	1239	85	0	0	271
2	351	694	316	85	0	0	161
3	716	1406	1210	69	0	0	288
4	625	1229	1077	53	0	0	288

***Note:** Performance and utilization data are generated targeting an LFE3-70E-8FN484CES device using Lattice Diamond 3.10 and Synplify Pro M-2017.03L-SP1-1. Performance may vary when using a different software version or targeting a different device density or speed grade within the LatticeECP3 family.

Ordering Part Number

The Ordering Part Number (OPN) for the CORDIC targeting LatticeECP3 devices is CORDIC-E3-U1.

LatticeSC and LatticeSCM Devices

Table A.7. Performance and Resource Utilization (LatticeSC and LatticeSCM)*

User-Configurable Mode	Slices	LUTs	Registers	I/Os	sysMEM EBRs	MULT18X18	fMAX (MHz)
1	900	1775	1265	85	0	0	363
2	380	743	329	85	0	0	207
3	1005	1984	1257	69	0	0	348
4	823	1618	1158	53	0	0	355

***Note:** Performance and utilization data are generated targeting an LFSC3GA25E-7F900C device using Lattice Diamond 3.10 and Synplify Pro M-2017.03L-SP1-1. Performance may vary when using a different software version or targeting a different device density or speed grade within the LatticeSC/M family.

Ordering Part Number

The Ordering Part Number (OPN) for the CORDIC targeting LatticeSC/M devices is CORDIC-SC-U1.

LatticeXP Devices

Table A.8. Performance and Resource Utilization (LatticeXP)*

User-Configurable Mode	Slices	LUTs	Registers	I/Os	sysMEM EBRs	MULT18X18	fMAX (MHz)
1	704	1345	1239	85	0	0	170
2	359	692	320	85	0	0	103
3	711	1331	1216	69	0	0	154
4	611	1159	1078	53	0	0	174

***Note:** Performance and utilization data are generated targeting an LFXP20E-5F484C device using Lattice Diamond 3.10 and Synplify Pro M-2017.03L-SP1-1. Performance may vary when using a different software version or targeting a different device density or speed grade within the LatticeXP family.

Ordering Part Number

The Ordering Part Number (OPN) for the CORDIC targeting LatticeXP devices is CORDIC-XM-U1.

LatticeXP2 Devices

Table A.9. Performance and Resource Utilization (LatticeXP2)*

User-Configurable Mode	Slices	LUTs	Registers	I/Os	sysMEM EBRs	MULT18X18	fMAX (MHz)
1	722	1423	1239	85	0	0	282
2	345	685	315	85	0	0	179
3	716	1408	1212	69	0	0	284
4	643	1269	1110	53	0	0	305

***Note:** Performance and utilization data are generated targeting an LFXP2-30E-7F484C device using Lattice Diamond 3.10 and Synplify Pro M-2017.03L-SP1-1. Performance may vary when using a different software version or targeting a different device density or speed grade within the LatticeXP2 family.

Ordering Part Number

The Ordering Part Number (OPN) for the CORDIC targeting LatticeXP2 devices is CORDIC-X2-U1.

ECP5 (LFE5U) Devices

Table A.10. Performance and Resource Utilization (ECP5 (LFE5U))*

User-Configurable Mode	Slices	LUTs	Registers	I/Os	sysMEM EBRs	MULT18X18	fMAX (MHz)
1	722	1423	1239	85	0	0	301
2	345	686	315	85	0	0	158
3	716	1408	1212	69	0	0	290
4	643	1269	1110	53	0	0	292

***Note:** Performance and utilization data are generated targeting an LFE5U-45F-8MG285C device using Lattice Diamond 3.10 and Synplify Pro M-2017.03L-SP1-1. Performance may vary when using a different software version or targeting a different device density or speed grade within the ECP5 (LFE5U) family.

Ordering Part Number

The Ordering Part Number (OPN) for the CORDIC targeting ECP5 (LFE5U) devices is CORDIC-E5-U.

ECP5 (LFE5UM) Devices

Table A.11. Performance and Resource Utilization (ECP5 (LFE5UM))*

User-Configurable Mode	Slices	LUTs	Registers	I/Os	sysMEM EBRs	MULT18X18	fMAX (MHz)
1	722	1423	1239	85	0	0	305
2	345	686	313	85	0	0	161
3	716	1408	1212	69	0	0	285
4	643	1269	1110	53	0	0	274

***Note:** Performance and utilization data are generated targeting an LFE5UM-45F-8BG554C device using Lattice Diamond 3.10 and Synplify Pro M-2017.03L-SP1-1. Performance may vary when using a different software version or targeting a different device density or speed grade within the ECP5 (LFE5UM) family.

Ordering Part Number

The Ordering Part Number (OPN) for the CORDIC targeting ECP5 (LFE5UM) devices is CORDIC-E5-U.

ECP5-5G (LFE5UM5G) Devices

Table A.12. Performance and Resource Utilization (ECP5-5G (LFE5UM5G))*

User-Configurable Mode	Slices	LUTs	Registers	I/Os	sysMEM EBRs	MULT18X18	fMAX (MHz)
1	722	1423	1239	85	0	0	282
2	345	685	315	85	0	0	179
3	716	1408	1212	69	0	0	284
4	643	1269	1110	53	0	0	305

***Note:** Performance and utilization data are generated targeting an LFE5UM5G-45F-8BG381C device using Lattice Diamond 3.10 and Synplify Pro M-2017.03L-SP1-1. Performance may vary when using a different software version or targeting a different device density or speed grade within the ECP5-5G (LFE5UM5G) family.

Ordering Part Number

The Ordering Part Number (OPN) for the CORDIC targeting ECP5-5G (LFE5UM5G) devices is CORDIC-E5-U.

Revision History

Revision 1.4, July 2018

Section	Change Summary
All	Changed document number from IPUG81 to FPGA-IPUG-02044.
Quick Facts	General update to Quick Facts tables.
Technical Support Assistance	General update.
Appendix A. Resource Utilization	<ul style="list-style-type: none"> Updated Table A.2. Performance and Resource Utilization (LatticeEC)*. Updated Table A.3. Performance and Resource Utilization (LatticeECP)*. Updated Table A.4. Performance and Resource Utilization (LatticeECP2)*. Updated Table A.5. Performance and Resource Utilization (LatticeECP2M)*. Updated Table A.6. Performance and Resource Utilization (LatticeECP3)*. Updated Table A.7. Performance and Resource Utilization (LatticeSC and LatticeSCM)*. Updated Table A.8. Performance and Resource Utilization (LatticeXP)*. Updated Table A.9. Performance and Resource Utilization (LatticeXP2)*. Added Table A.10. Performance and Resource Utilization (ECP5 (LFESU))*. Added Table A.11. Performance and Resource Utilization (ECP5 (LFESUM))*. Added Table A.12. Performance and Resource Utilization (ECP5-5G (LFESUM5G))*.

Revision 1.3, August 2012

Section	Change Summary
All	Updated document with the new corporate logo.
Functional Description	Configuring the CORDIC IP Core text section, under the Compensation Specification subsection, updated the text associated with the None bullet.

Revision 1.2, December 2010

Section	Change Summary
All	Added support for Diamond software throughout.

Revision 1.1, June 2010

Section	Change Summary
All	<ul style="list-style-type: none"> Divided document into chapters. Added table of contents.
Introduction	Added Quick Facts table.
IP Core Generation	Added new content.
Core Verification	Added new content.

Revision 1.0, May 2009

Section	Change Summary
All	Initial release.



7th Floor, 111 SW 5th Avenue
Portland, OR 97204, USA
T 503.268.8000
www.latticesemi.com