

**E-Series Surface Mount Mixer**  
2110 – 2170 MHz

**EFM-2100**  
**V2**

**Features**

- LO Power +13 dBm
- +22dB Compression Point
- Surface Mount
- +32dBm IIP3
- Up and Down Converting
- Tape and reel packaging available

**Description**

M/A Com's EFM-2100 uses a novel, patent pending design to achieve very high linearity at low LO drive levels. Typically IP3 performance is +32dBm with an LO drive level of just +13dBm. The mixer combines PHEMT devices and carefully matched transformers in a surface mount package which can be used for both up and down converting. It is ideally suited for wireless applications where high linearity is required. Parts are packaged in tape & reel.

**SM - 106 - Non Hermetic Package**

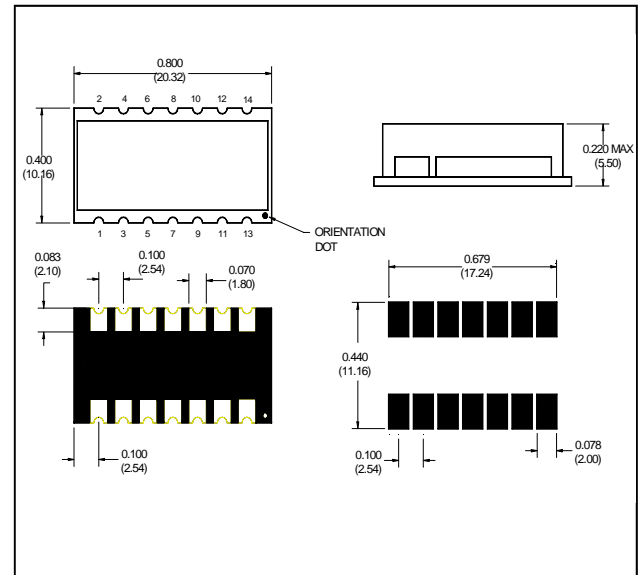

**Electrical Specifications:  $T_A = 25^\circ\text{C}$ ,  $Z_0 = 50\Omega$ <sup>1</sup>**

Parameter	Test Conditions	Frequency	Units	Min	Typ	Max
RF Frequency	DC bias 3V ± 0.3V	2110 - 2170	MHz	—	—	—
LO Frequency	DC bias 3V ± 0.3V	1650 - 2070	MHz	—	—	—
IF Frequency	DC bias 3V ± 0.3V	100 - 500	MHz	—	—	—
Conversion Loss	—	2110 - 2170	dB	-	8.5	10.0
Isolation	LO to RF	1650 - 2070	dB	10.0	16.0	—
Isolation	LO to IF	1650 - 2070	dB	20.0	25.0	—
Isolation	RF to IF	2110 - 2170	dB	25	35	—
VSWR	LO	1650 - 2070	—	—	2.5	—
VSWR	RF	2110 - 2170	—	—	2.8	—

**Ordering Information**

Part Number	Package
EFM-2100TR	Tape and Reel (300 piece Reel)

**Electrical Specifications:  $T_A = 25^\circ\text{C}$ ,  $Z_0 = 50\Omega$  <sup>1</sup>**

Parameter	Test Conditions	Frequency	Units	Min	Typ	Max
IF VSWR	—	100 - 500	—	—	1.8	—
Input IP3	Up Converting	—	dBm	30.0	34.0	—
Input IP3	Down Converting	—	dBm	30.0	34.0	—
Input 1dB Compression	—	1850 - 1980	dBm	—	22.0	—

**Pin Configuration**

Pin No.	Function		
1	Ground	8	Ground
2	RF	9	LO
3	Ground	10	Ground
4	Ground	11	Ground
5	Ground	12	Ground
6	Ground	13	Bias
7	Ground	14	IF

**Schematic**

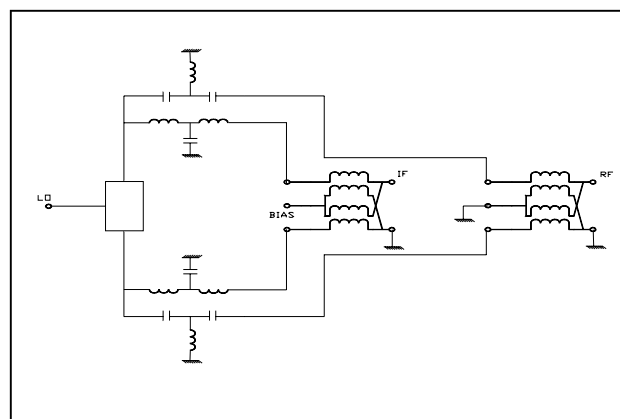

**Absolute Maximum Ratings <sup>1</sup>**

Parameter	Absolute Maximum
Max RF Power	200 mW
Peak IF Current	40 mA
Operating Temperature	-40°C to +85°C
Storage Temperature	-55°C to +125°C
ESD Rating	Zero

1. Operation of this device above any one of these parameters may cause permanent damage.

**Typical Performance Curves**

**Conversion Loss**

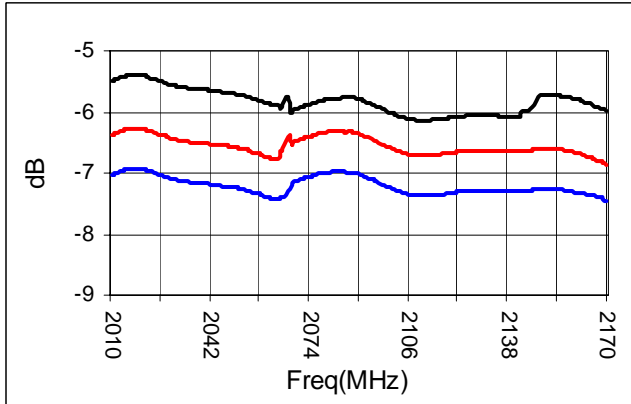

**LO - RF Isolation**

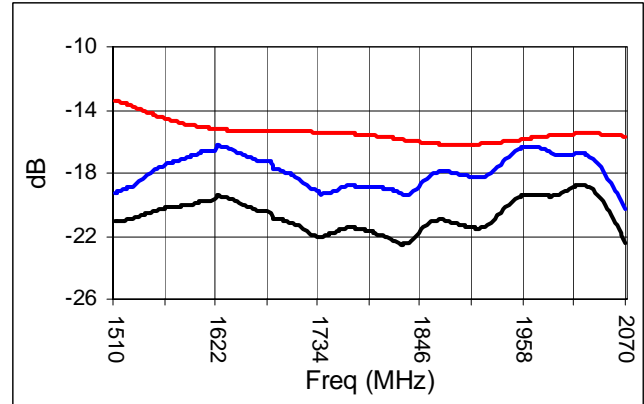

**LO—IF Isolation**

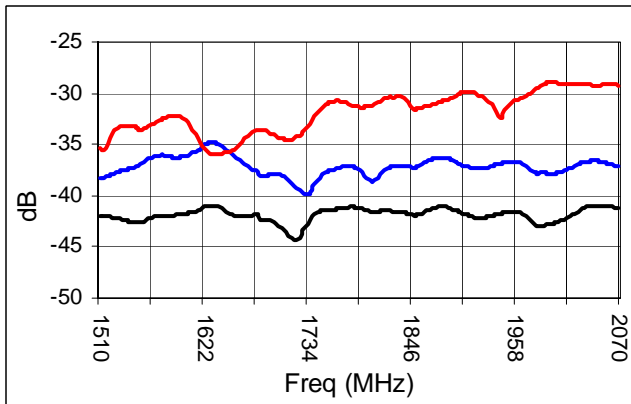

**IIP3**

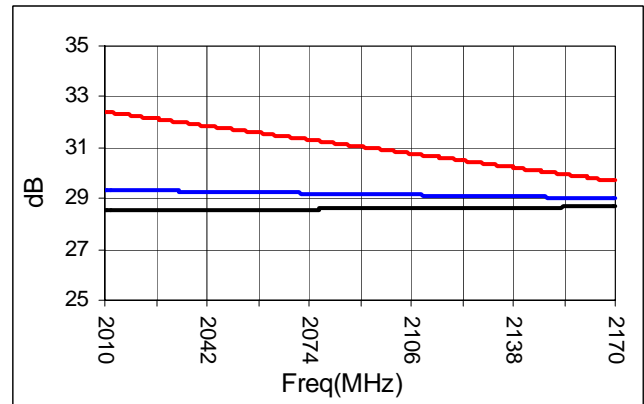

**1 dB Compression Point**

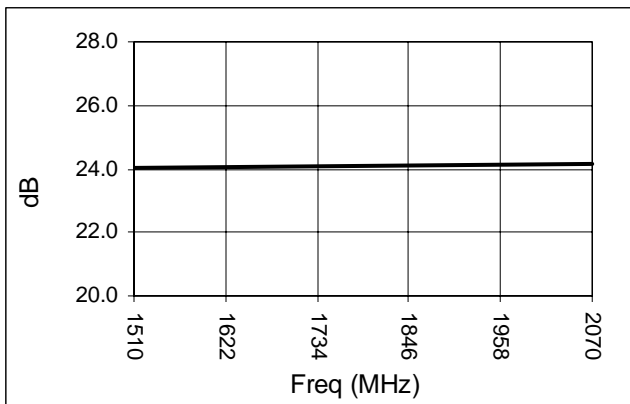

**E-Series Surface Mount Mixer**  
2110 – 2170 MHz

**EFM-2100**  
**V2**

**Spurious Table: 2100MHz**

(In dBc below IF, assuming down conversion)

		nf <sub>LO</sub> - mf <sub>RF</sub>					
		0	X	9	17	22	30
		1	35	0	37	57	45
RF		2	77	77	56	77	77
(n)		3	77	77	77	70	77
		4	77	77	77	77	77
		0	1	2	3	4	

LO (m)

RF = 2110 MHz, 0dBm  
LO = 2010 MHz, +13dBm  
IF = 100 MHz

**Spurious Table: 2100MHz**

(In dBc below IF, assuming down conversion)

		nf <sub>LO</sub> - mf <sub>RF</sub>					
		0	X	8	12	10	23
		1	25	0	28	59	61
RF		2	77	77	62	52	77
(n)		3	77	77	77	77	70
		4	77	77	77	77	77
		0	1	2	3	4	

LO (m)

RF = 2100 MHz, 0dBm  
LO = 1610 MHz, +13dBm  
IF = 500 MHz

**Spurious Table: 2170MHz**

(In dBc below IF, assuming down conversion)

		nf <sub>LO</sub> - mf <sub>RF</sub>					
		0	X	10	13	22	32
		1	33	0	45	59	47
RF		2	70	77	48	74	69
(n)		3	71	77	77	66	77
		4	77	77	77	77	77
		0	1	2	3	4	

LO (m)

RF = 2170 MHz, 0dBm  
LO = 2070 MHz, +13dBm  
IF = 100 MHz

**Spurious Table: 2170MHz**

(In dBc below IF, assuming down conversion)

		nf <sub>LO</sub> - mf <sub>RF</sub>					
		0	X	10	12	16	17
		1	34	0	39	54	65
RF		2	73	77	65	60	77
(n)		3	77	77	77	77	77
		4	77	77	77	77	77
		0	1	2	3	4	

LO (m)

RF = 2170 MHz, 0dBm  
LO = 1670 MHz, +13dBm  
IF = 500 MHz