

Comparator click

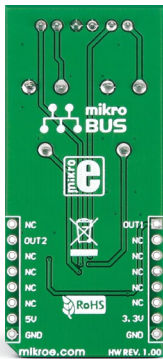
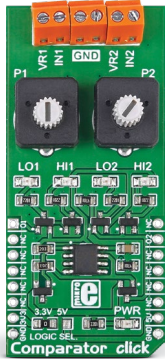

1. Introduction

Comparator click, carrying the **LM2903** IC, has two independent precision voltage comparators. Two pairs of screw terminals allow you to connect separate inputs [additional two screw terminals are for GND connections]. Two potentiometers are placed between the terminals and the IC. Each input has its own Interrupt pin on the mikroBUS™ socket [one on the INT pin, the other in place of the mikroBUS™ AN pin], here marked O1 and O2.

2. Soldering the headers

Before using your click board™, make sure to solder 1x8 male headers to both left and right side of the board. Two 1x8 male headers are included with the board in the package.

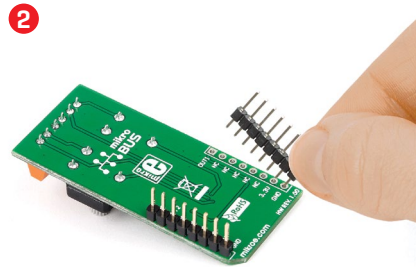
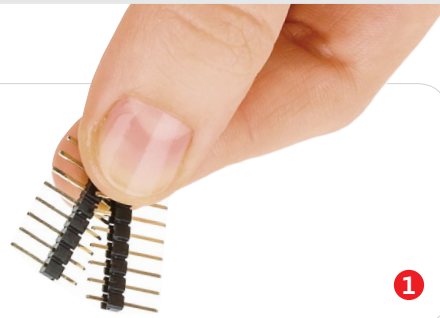

Turn the board upside down so that the bottom side is facing you upwards. Place shorter pins of the header into the appropriate soldering pads.

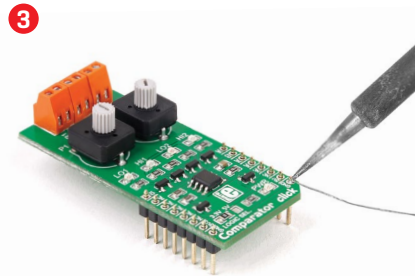

Turn the board upward again. Make sure to align the headers so that they are perpendicular to the board, then solder the pins carefully.

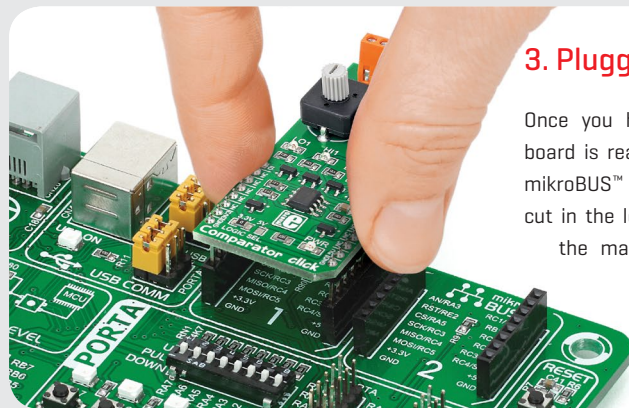

3. Plugging the board in

Once you have soldered the headers your board is ready to be placed into the desired mikroBUS™ socket. Make sure to align the cut in the lower-right part of the board with the markings on the silkscreen at the mikroBUS™ socket. If all the pins are aligned correctly, push the board all the way into the socket.

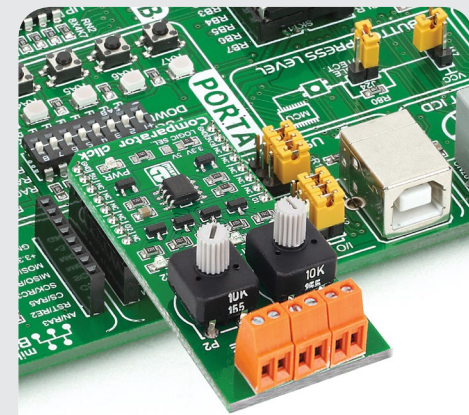

4. Essential features

Comparator click can be used with a single or dual power supply. If a single power supply is used, the offset voltage can be as low as 2.0 mV, with a range from 2.0 VDC to 36 VDC. For dual supplies, the range is from ± 1.0 VDC to ± 18 VDC. The resulting output is compatible with TTL, DTL, ECL, MOS and CMOS logic systems.

click
BOARD™
www.mikroe.com



Comparator click manual
ver 1.01



5. Schematic

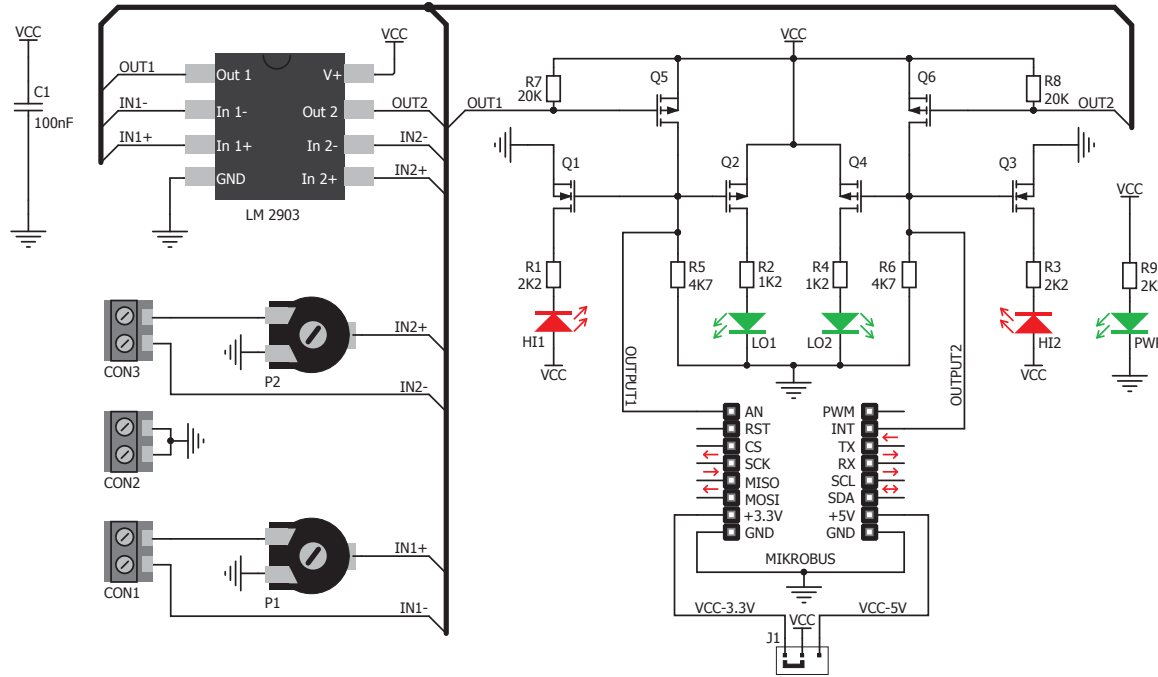

6. Dimensions

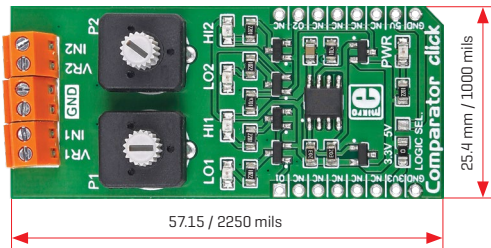

	mm	mils
LENGTH	57.15	2250
WIDTH	25.4	1000
HEIGHT*	15	590

* without headers

7. SMD jumper



LOGIC SEL is used to determine whether 5V or 3.3V logic level is used on the interrupt pins.

8. Code examples

Once you have done all the necessary preparations, it's time to get your click board™ up and running. We have provided examples for mikroC™, mikroBasic™ and mikroPascal™ compilers on our **Libstock** website. Just download them and you are ready to start.



9. Support

MikroElektronika offers **free tech support** [www.mikroe.com/support] until the end of the product's lifetime, so if something goes wrong, we're ready and willing to help!



10. Disclaimer

MikroElektronika assumes no responsibility or liability for any errors or inaccuracies that may appear in the present document. Specification and information contained in the present schematic are subject to change at any time without notice.

Copyright © 2015 MikroElektronika.
All rights reserved.