

Compact and good operational feel, suitable for mixing console faders



Typical Specifications



Items	Specifications
Total resistance tolerance	±20%
Maximum operating voltage	200V AC, 10V DC (Single-unit) 150V AC, 10V DC (Dual-unit)
Operating force	0.5 $\begin{smallmatrix} +1.0 \\ -0.4 \end{smallmatrix}$ N
Operating life	30,000 cycles
Operating temperature range	-10°C to +60°C

Product Line

Number of resistor elements	Travel (mm)	Lever type	Length of lever (mm)	Total resistance (kΩ)	Resistance taper	Minimum order unit (pcs.)		Products No.
						Japan	Export	
Single-unit	60	6	15	10	1B	900	900	RS6011SP6003
				20				RS6011SP6004
Dual-unit				10	15A			RS6011DP6002
				20				RS6011DP6003

Note

Other varieties are also available. Refer to "Other Specifications" (P.409).

Packing Specifications

Tray

Number of packages (pcs.)		Export package measurements (mm)
1 case /Japan	1 case /export packing	
900	900	529×373×273

Dimensions

Style	PC board mounting hole dimensions (Viewed from mounting side)
	<p>The RS6011SP uses lug terminals for terminals 1' 2' 3'.</p>

Refer to P.409 for other specifications.
 Refer to P.409 for details of lever types.
 Refer to P.410 for ordering products not listed.
 Refer to P.417 for soldering conditions.

Rotary Potentiometers
 Slide Potentiometers
 General-use
 Mixer

In addition to the products listed, we can accommodate the follow specifications.

Total Resistance Variety

Total resistance (k Ω)	10	20	50
------------------------	----	----	----

Resistance Taper

Resistance taper	15A	1B	10A
------------------	-----	----	-----

Lever Types

Unit:mm

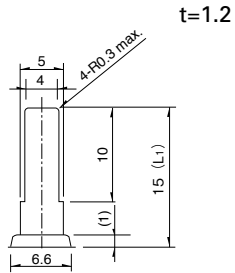
Configuration code	6 (Metal lever)
Dimensions	
Length L ₁	15

Terminal Layout / Circuit Diagram (Viewed from Mounting Side)

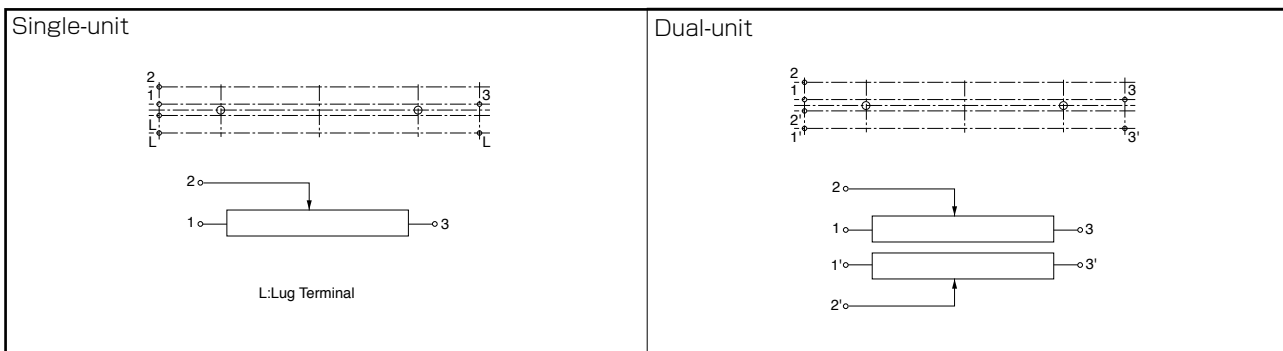

Corresponding Specifications

Dust cover	Available
------------	-----------

Notes

1. Marked are specifications recommended by Alps Alpine.
2. A variety of operational feels are available, so please inquire if you have a request.

When ordering product varieties that are not listed, specify referring to the examples below.

■ Sample Part Number

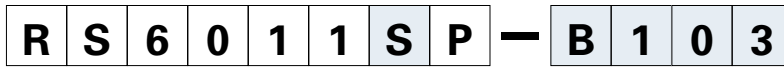

Number of resistor elements

Single-unit	S
Dual-unit	D

Resistance taper



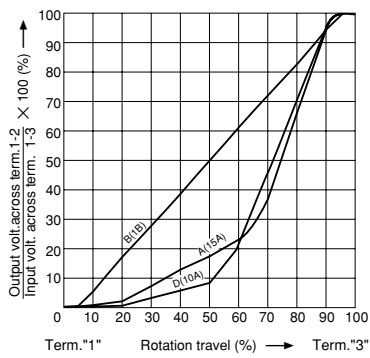







Code	Resistance taper
A	15A
B	1B
D	10A



Total resistance

Code	Total resistance (k Ω)
103	10
203	20
503	50

Rotary Potentiometers
 Slide Potentiometers
 General-use
 Mixer

Type		Low-profile Master Type		Motor-driven Master Type		
Series		Slim Type	Super P Fader	Motor N Fader	Motor K Fader	Motor V Fader
		RS □□ N11S	RS6011 □ P	RS □□ N1 □ M	RSA0K1 □ V	RSA0V11M
		Single-unit	Single-unit/Dual-unit	Single-unit/Dual-unit	Single-unit/Dual-unit	Single-unit
Photo						
Travel (mm)		60, 100	60	60, 100	100	
Direction of lever		Vertical				
Lever material		Metal				Resin
Operating temperature range		-10°C to +60°C				
Operating life		30,000 cycles			300,000 cycles	100,000 cycles
Available for automotive use		—	—	—	—	—
Life cycle						
Electrical performance	Total resistance (k Ω)	10, 50, 100, 250	10, 20, 50	10, 50, 100, 250	10	
	Resistance taper	15A, 1B, 10A		Single-unit: 1B Dual-unit: Servo 1B Audio 15A, 1B, 10A		1B
	Rated Power	0.2W (RS60N11S) 0.5W (RSA0N11S)	0.2W (Single-unit) 0.1W (Dual-unit)	0.2W (RS60N1□M) 0.5W (RSA0N1□M)	0.5W	
	Insulation resistance	100MΩ min. 250V DC				
	Voltage proof	250V AC for 1 minute				
	Center-taps	Without				
Mechanical performance	Operating force	0.3 ^{+0.5} _{-0.25} N	0.5 ^{+1.0} _{-0.4} N	0.8±0.5N	Single-unit: 0.4±0.25N Dual-unit: 0.25 to 0.9N	—
	Center detent	Without				
	Stopper strength	100N				10N
	Lever push-pull strength	50N				20N
	Lever wobble (mm) * Both sides	$\frac{2(2 \times L)}{25}$				
	Lever deviation (mm)	0.5 max. (One side)				
Terminal style		Insertion		Lead, Insertion	Connector (Fader) Lead (Motor)	Connector
Page		405	408	411		

Slide Potentiometers Soldering Conditions	417
Potentiometer Cautions	418
Potentiometers Measurement and Test Methods	420
Potentiometers Resistance Taper	422

Notes

- Attenuation is specified for residual resistance.
- "L" in the "Lever Wobble" column of the above table indicates the length of lever.

Reference for Manual Soldering

Series	Tip temperature	Duration of Soldering time	No. of solders
RS□□1, RS08U, RS□□K (Standard), RS□□N, RS□□N11S, RS6011□P, RS□□N1□M, RSA0K1□V (Motor terminal)	350°C max.	3s max.	1 time

Reference for Dip Soldering

Series	Preheating		Dip soldering		Number of soldering
	Soldering surface temperature	Heating time	Soldering temperature	Soldering time	
RS□□1, RS□□N, RS□□N11S, RS6011□P, RS□□N1□M	100°C max.	1 min. max.	260°C	5s max.	1 time

Example of Reflow Soldering Condition

Temperature profile

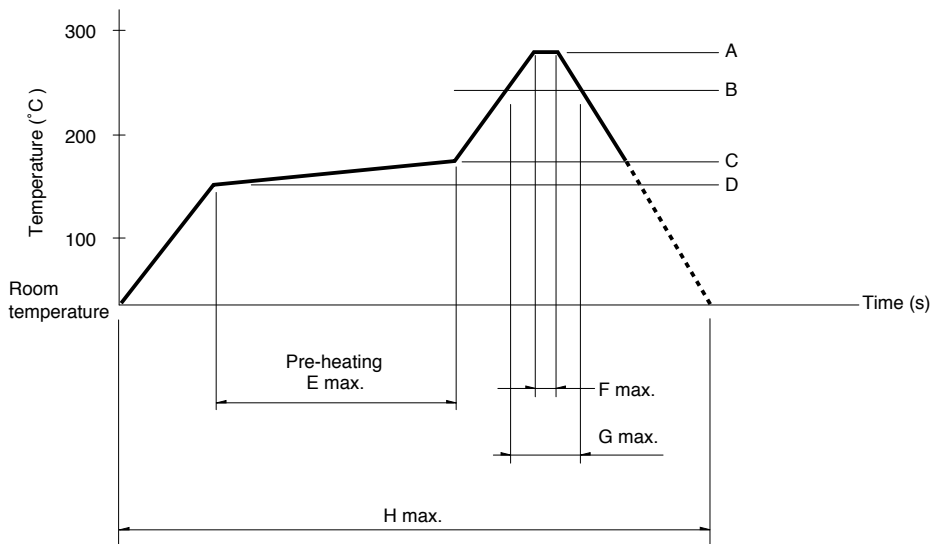

Series	A	B	C	D	E	F	G	H	No. of reflows
RS08U	250°C	200°C	150°C	150°C	2 min.	3s	40s	4 min.	1 time

Notes

1. When using an infrared reflow oven, solder may sometimes not be applied. Be sure to use a hot air reflow oven or a type that uses infrared rays in combination with hot air.
2. The temperatures given above are the maximum temperatures at the terminals of the products when employing a hot air reflow method. The temperature of the PC board and the surface temperature of the products may vary greatly depending on the PC board material, its size and thickness. Ensure that the surface temperature of the products does not rise to 250°C or greater.
3. Conditions vary to some extent depending on the type of reflow bath used. Be sure to give due consideration to this prior to use.