

W28 series

Push to Reset Fuseholder-Type Thermal P&B Circuit Breaker



Note: VDE not available on 16A and 20A W28 only.

Features

- Push to reset.
- Approved to many international standards.
- Replaces slow blow glass cartridge fuse.
- Labor-saving snap-in mounting.
- Button extends for visual trip indication.

Agency Approvals

W28 series is UL 1077 Recognized as Supplementary Protectors, File E69543, and CSA Accepted as Supplementary Protectors (Appliance Component Protectors), File LR15734. W28 breakers are VDE approved for use in office equipment (AC loads only) and provides 8mm isolation. 16 amp and 20 amp models do not have VDE approvals at present. CCC mark compliant, certificate 2004010307135992.

Users should thoroughly review the technical data before selecting a product part number. It is recommended that users also seek out the pertinent approvals files of the agencies/laboratories and review them to confirm the product meets the requirements for a given application.

Electrical Data @ 25°C

Calibration: Will continuously carry 100% of rating.
 3-20 amp models – may trip between 101% and 134%, but must trip at 135% of rating within one hour at +25°C.
 0.25-2 amp models – may trip between 101% and 174%, but must trip at 175% of rating within one hour at +25°C.
 Dielectric Strength: Over 1,500 volts RMS.
 Maximum Operating Voltages: 32VDC; 250VAC, 50/60 Hz.
 Interrupt Capacity: 1,000 amps at 250VAC, 50/60 Hz. and 32VDC in accordance with UL standard 1077.

Resettable Overload Capacity: Six times rated current for 0.25 through 2 amp models. Ten times rated current for 3 through 20 amp models.
 Reset Time: 180 seconds max. for 0.25 through 2 amp models. 5 to 30 seconds for 3 through 20 amp models.

Typical Resistance vs. Current Rating @ +25°C

Current Rating in Amps	Typical Resistance in Ohms	Current Rating in Amps	Typical Resistance in Ohms
0.25	14.0	8.0	0.016
0.50	3.55	9.0	0.014
0.75	2.0	10.0	0.011
1.0	0.89	11.0	0.01
2.0	0.17	12.0	0.009
3.0	0.069	13.0	0.009
4.0	0.043	14.0	0.007
5.0	0.030	15.0	0.007
6.0	0.026	16.0	0.007
7.0	0.017	20.0	0.006

Mechanical/Environmental Data

Termination: .250" (6.35mm) quick connects. Soldering to terminals is not recommended.
 Mounting: Snaps into panel from front. See Recommended Panel Cutouts.
 Approximate Weight: 0.35 oz. (10g).

Time vs. Current Trip Curve @ +25°C



Ambient Compensation Chart



To use this chart: Read up from the ambient temperature to the curve, and across to find a correction factor. Multiply the breaker rating by the correction factor to determine the compensated rating. Calculate the overloads in terms of the compensated rating to use the published trip curve. Do not use these devices outside their specified operating temperature ranges.

Ordering Information

Typical Part Number >		W	28	-X	Q	1	A	-5																				
1. Designator: W = Circuit breaker																												
2. Series Number: 28 = Single Pole Fuseholder Type																												
3. Circuit Function: X = Series Trip, Push-to-Reset Button																												
4. Terminal Type and Mounting: Q = .250" (6.35mm) Quick Connect will mount in .032"-.062" (.813mm - 1.574mm) thick panel. T = .250" (6.35mm) Quick Connect will mount in .075"-.105" (1.905mm - 2.667mm) thick panel. For panel thicknesses other than above, order "Q" type and 55-025B Internal Tooth Push-On Lockwasher.																												
5. Bezel Color: 1 = Black with White Rate Marking 2 = Red with White Rate Marking B = Black with White "Reset" Marked On Bezel (No Rate Marking) 11 = Black with No Rate Marking 21 = Red with No Rate Marking Consult factory for other bezel colors.																												
6. Button Color: A = Black B = Red Consult factory for other button colors.																												
7. Amp Rating:		<table border="1"> <tr> <td>0.25</td><td>0.75</td><td>2</td><td>4</td><td>6</td><td>8</td><td>10</td><td>12</td><td>14</td><td>20</td> </tr> <tr> <td>0.50</td><td>1</td><td>3</td><td>5</td><td>7</td><td>9</td><td>11</td><td>13</td><td>16</td><td></td> </tr> </table>							0.25	0.75	2	4	6	8	10	12	14	20	0.50	1	3	5	7	9	11	13	16	
0.25	0.75	2	4	6	8	10	12	14	20																			
0.50	1	3	5	7	9	11	13	16																				

Note: All standard part numbers in this series are RoHS compliant.

Stock Items – Authorized distributors are more likely to stock the following items.

W28-XQ1A-0.25	W28-XQ1A-1	W28-XQ1A-4	W28-XQ1A-7	W28-XQ1A-12	W28-XT1A-10
W28-XQ1A-0.50	W28-XQ1A-2	W28-XQ1A-5	W28-XQ1A-8	W28-XQ1A-15	W28-XT1A-12
W28-XQ1A-0.75	W28-XQ1A-3	W28-XQ1A-6	W28-XQ1A-10	W28-XQ1A-20	

Outline Dimensions

Push-to-Reset Type

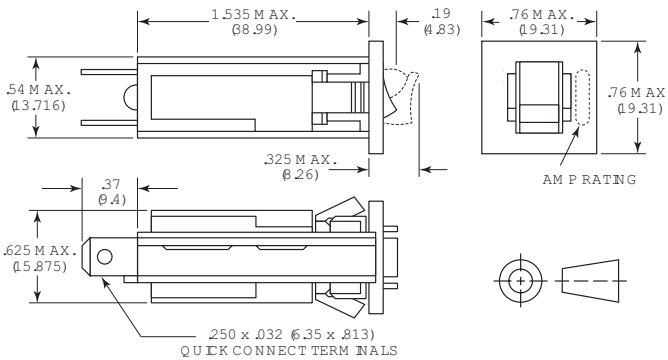

- Notes:
- Soldering to terminals is not recommended.
 - Recommended Panel Thickness: Style Q: .032" - .062" (.813 mm - 1.574 mm)
Style T: .075" - .105" (1.905 mm - 2.667 mm)
 - Internal tooth push-on washer available for panel thickness not covered above. Part No. 55-025B.

Recommended Panel Cutouts



Optional Internal Tooth Push-On Lockwasher

For panels greater than .105 (2.67) thickness 55-025B



55-025B
INTERNAL TOOTH
PUSH-ON LOCKWASHER
For panels greater than .105" (2.67) thickness

Disclaimer

While TE has made every reasonable effort to ensure the accuracy of the information in this document, TE does not guarantee that it is error-free, nor does TE make any other representation, warranty or guarantee that the information is accurate, correct, reliable or current.

TE reserves the right to make any adjustments to the information contained herein at any time without notice. TE expressly disclaims all implied warranties regarding the information contained herein, including, but not limited to, any implied warranties of merchantability or fitness for a particular purpose.

The dimensions in this catalog are for reference purposes only and are subject to change without notice. Specifications are subject to change without notice. Consult TE for the latest dimensions and design specifications.