



Main

Range of product	Altivar Machine ATV320
Product or component type	Variable speed drive
Product specific application	Complex machines
Device short name	ATV320
Format of the drive	Compact
Product destination	Asynchronous motors Synchronous motors
EMC filter	Without EMC filter
IP degree of protection	IP20 conforming to EN/IEC 61800-5-1
Degree of protection	UL type 1 with UL type 1 conformity kit
Type of cooling	Fan
Phase	3 phases
[Us] rated supply voltage	200...240 V (- 15...10 %)
Supply frequency	50...60 Hz (- 5...5 %)
Motor power kW	15 kW heavy duty
Motor power hp	20 hp heavy duty
Line current	79.7 A at 200 V heavy duty 67.1 A at 240 V heavy duty
Prospective line I _{sc}	22 kA
Apparent power	27.9 kVA at 240 V heavy duty
Continuous output current	66 A at 4 kHz heavy duty
Maximum transient current	99 A during 60 s heavy duty
Asynchronous motor control profile	Voltage/frequency ratio, 2 points Voltage/frequency ratio, 5 points Flux vector control without sensor, standard Voltage/frequency ratio - Energy Saving, quadratic U/f Flux vector control without sensor - Energy Saving
Synchronous motor control profile	Vector control without sensor
Speed drive output frequency	0.1...599 Hz
Nominal switching frequency	4 kHz
Switching frequency	2...16 kHz adjustable 4...16 kHz with current derating
Safety function	STO (safe torque off) SIL 3 SS1 (safe stop 1) SMS (safe maximum speed) SLS (safe limited speed) GDL (guard door locking)
Communication port protocol	CANopen Modbus
Option card	Communication module: CANopen daisy chain RJ45 Communication module: CANopen SUB-D 9 Communication module: CANopen open style terminal block Communication module: EtherCAT RJ45 Communication module: DeviceNet Communication module: Ethernet/IP Communication module: Profibus DP V1 Communication module: Profinet Communication module: Ethernet Powerlink

Complementary

The information provided in this documentation contains general descriptions and/or technical characteristics of the performance of the products contained herein. This documentation is not intended as a substitute for and is not to be used for determining suitability or reliability of these products for specific user applications. It is the duty of any such user or integrator to perform the appropriate and complete risk analysis, evaluation and testing of the products with respect to the relevant specific application or use thereof. Neither Schneider Electric Industries SAS nor any of its affiliates or subsidiaries shall be responsible or liable for misuse of the information contained herein.

Variant	Standard version
Output voltage	<= power supply voltage
Permissible temporary current boost	1.5 x In during 60 s heavy duty
Speed range	With asynchronous motor in open-loop mode
Speed accuracy	+/- 10 % of nominal slip 0.2 Tn to Tn
Torque accuracy	+/- 15 %
Transient overtorque	170...200 % of nominal motor torque
Braking torque	<= 170 % with braking resistor during 60 s
Regulation loop	Adjustable PID regulator
Motor slip compensation	Automatic whatever the load Not available in voltage/frequency ratio (2 or 5 points) Adjustable 0...300 %
Acceleration and deceleration ramps	S U CUS Deceleration ramp automatic stop DC injection Deceleration ramp adaptation Linear Ramp switching
Braking to standstill	By DC injection
Protection type	Drive: thermal protection Drive: overcurrent between output phases and earth Drive: input phase breaks Drive: overheating protection Drive: short-circuit between motor phases
Frequency resolution	Display unit: 0.1 Hz Analog input: 0.012/50 Hz
Electrical connection	Control, screw terminal: 0.5...1.5 mm ² AWG 20...AWG 16 Motor/braking resistor, screw terminal: 2 x 16 mm ² 2 x AWG 6 Power supply, screw terminal: 2 x 16 mm ² 2 x AWG 6
Connector type	1 RJ45 Modbus/CANopen on control terminal
Physical interface	2-wire RS 485 Modbus
Transmission frame	RTU Modbus
Transmission rate	4.8, 9.6, 19.2, 38.4 kbit/s Modbus 50 kbps, 125 kbps, 250 kbps, 500 kbps, 1 Mbps CANopen
Data format	8 bits, configurable odd, even or no parity Modbus
Type of polarization	No impedance Modbus
Number of addresses	CANopen Modbus
Method of access	Slave CANopen
Supply	Internal supply for reference potentiometer (1 to 10 kOhm): 10.5 V DC (+/- 5 %) current <= 10 mA (overload and short-circuit protection)
Local signalling	1 LED green CANopen run 1 LED red CANopen error 1 LED red drive fault
Width	7.09 in (180 mm)
Height	12.99 in (330 mm) 15.94 in (405 mm) with EMC plate
Depth	7.8 in (198 mm)
Product weight	15.21 lb(US) (6.9 kg)
Analogue input number	3
Analogue input type	Voltage (AI1): 0...10 V DC, impedance 30000 Ohm, resolution 10 bits Bipolar differential voltage (AI2): +/- 10 V DC, impedance 30000 Ohm, resolution 10 bits Current (AI3): 0...20 mA (or 4-20 mA, x-20 mA, 20-x mA or other patterns by configuration), impedance 250 Ohm, resolution 10 bits
Discrete input number	7
Discrete input type	Programmable (sink/source) (DI1...DI4): 24...30 V DC: level 1 PLC Programmable as pulse input 20 kpps (DI5): 24...30 V DC: level 1 PLC Switch-configurable PTC probe (DI6): 24...30 V DC Safe torque off (STO): 24...30 V DC, impedance 1500 Ohm
Discrete input logic	Negative logic (sink) : DI1...DI6, > 19 V (state 0) < 13 V (state 1) Positive logic (source) : DI1...DI6, < 5 V (state 0) > 11 V (state 1)
Analogue output number	1

Analogue output type	Software-configurable current (AQ1): 0...20 mA, impedance 800 Ohm, resolution 10 bits Software-configurable voltage (AQ1): 0...10 V, impedance 470 Ohm, resolution 10 bits
Sampling duration	Analog input (AI1, AI2, AI3): 2 ms Analog output (AQ1): 2 ms
Accuracy	Analog input AI1, AI2, AI3: +/- 0.2 % for a temperature of -10...60 °C Analog input AI1, AI2, AI3: +/- 0.5 % for a temperature of 25 °C Analog output AQ1: +/- 1 % for a temperature of 25 °C Analog output AQ1: +/- 2 % for a temperature of -10...60 °C
Linearity error	Analog input (AI1, AI2, AI3): +/- 0.2...0.5 % of maximum value Analog output (AQ1): +/- 0.3 %
Discrete output number	3
Discrete output type	Configurable relay logic NO/NC (R1A, R1B, R1C): electrical durability 100000 cycles Configurable relay logic NO (R2A, R2B): electrical durability 100000 cycles Logic (LO)
Refresh time	Logic input (DI1...DI6): 8 ms (+/- 0.7 ms) Relay output (R1A, R1B, R1C): 2 ms Relay output (R2A, R2C): 2 ms
Minimum switching current	Relay output (R1, R2): 5 mA at 24 V DC
Maximum switching current	Relay output (R1) on resistive load (cos phi = 1): 3 A at 250 V AC Relay output (R1) on resistive load (cos phi = 1): 4 A at 30 V DC Relay output (R1, R2) on inductive load (cos phi = 0.4): 2 A at 250 V AC Relay output (R1, R2) on inductive load (cos phi = 0.4): 2 A at 30 V DC Relay output (R2) on resistive load (cos phi = 1): 5 A at 250 V AC Relay output (R2) on resistive load (cos phi = 1): 5 A at 30 V DC
Discrete and process manufacturing	Hoisting self erecting Material handling carousel Material handling conveyor Material handling lifting platform Material handling palletizers - medium performance Material handling transfer table Material handling turn table Material working (wood, ceramic, stone, pvc, metal) cutting - medium accuracy Material working (wood, ceramic, stone, pvc, metal) drilling Material working (wood, ceramic, stone, pvc, metal) saw Packaging bagging Packaging feed conveyor low performance Packaging filling bottles - intermittent operation Packaging linear labeling Packaging other application Packaging stretching wrapping Packaging tray take Textile knitting Textile printing machines Textile spinning Washing machines car Washing machines other application Hoisting standard crane - travelling or trolley
Power range	15...25 kW 200...240 V 3 phases
Motor starter type	Variable speed drive

Environment

isolation	Between power and control terminals
insulation resistance	> 1 mOhm at 500 V DC for 1 minute to earth
noise level	58 dB conforming to 86/188/EEC
power dissipation in W	545 W (fan) at 200 V, 4 kHz
volume of cooling air	41211.58 Gal/hr(US) (156 m3/h)
operating position	Vertical +/- 10 degree
electromagnetic compatibility	Conducted radio-frequency immunity test conforming to IEC 61000-4-6 level 3 Electrical fast transient/burst immunity test conforming to IEC 61000-4-4 level 4 Electrostatic discharge immunity test conforming to IEC 61000-4-2 level 3 Radiated radio-frequency electromagnetic field immunity test conforming to IEC 61000-4-3 level 3 Voltage dips and interruptions immunity test conforming to IEC 61000-4-11 1.2/50 µs - 8/20 µs surge immunity test conforming to IEC 61000-4-5 level 3
pollution degree	2 conforming to EN/IEC 61800-5-1
vibration resistance	1 gn (f = 13...200 Hz) conforming to EN/IEC 60068-2-6 1.5 mm peak to peak (f = 2...13 Hz) conforming to EN/IEC 60068-2-6

shock resistance	15 gn during 11 ms conforming to EN/IEC 60068-2-27
relative humidity	5...95 % without condensation conforming to IEC 60068-2-3 5...95 % without dripping water conforming to IEC 60068-2-3
ambient air temperature for operation	14...122 °F (-10...50 °C) without derating 122...140 °F (50...60 °C) with derating factor
ambient air temperature for storage	-13...158 °F (-25...70 °C)
operating altitude	<= 3280.84 ft (1000 m) without derating 3280.84...9842.52 ft (1000...3000 m) with current derating 1 % per 100 m
environmental characteristic	Chemical pollution resistance class 3C3 EN/IEC 60721-3-3 Dust pollution resistance class 3S2 EN/IEC 60721-3-3
standards	EN/IEC 61800-3 EN/IEC 61800-3 environment 1 category C2 EN/IEC 61800-5-1 IEC 60721-3 IEC 61508 IEC 13849-1
product certifications	CSA NOM 117 UL RCM EAC
marking	CE

Offer Sustainability

Green Premium product	Green Premium product
Compliant - since 1714 - Schneider Electric declaration of conformity	Compliant - since 1714 - Schneider Electric declaration of conformity
Reference not containing SVHC above the threshold	Reference not containing SVHC above the threshold
Available	Available
Available	Available
WARNING: This product can expose you to chemicals including:	WARNING: This product can expose you to chemicals including:
Lead and lead compounds, which is known to the State of California to cause cancer and birth defects or other reproductive harm.	Lead and lead compounds, which is known to the State of California to cause cancer and birth defects or other reproductive harm.
For more information go to www.p65warnings.ca.gov	For more information go to www.p65warnings.ca.gov

Dimensions

Right and Front View

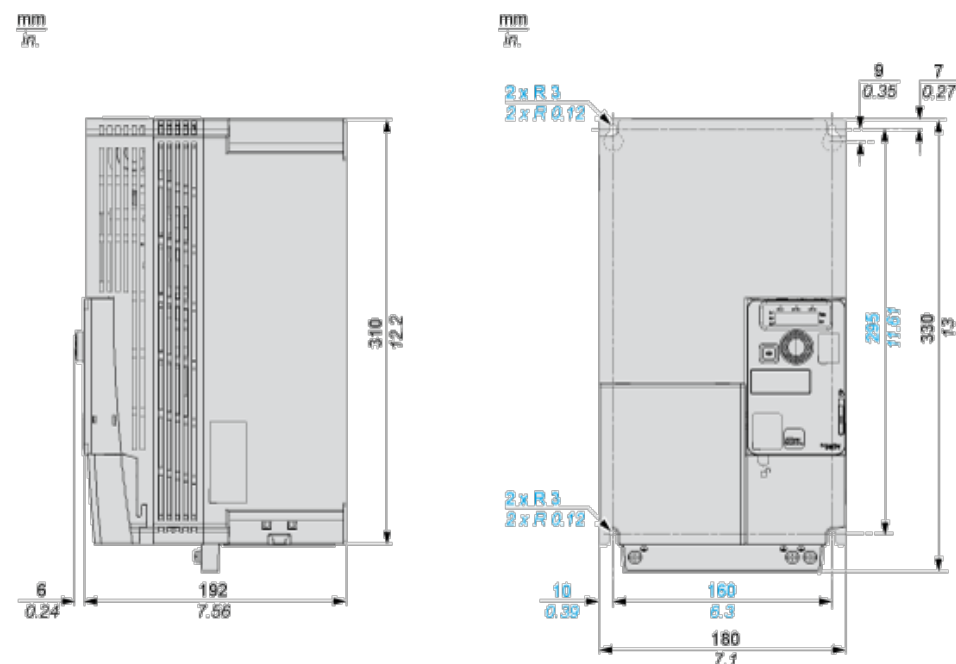

Right and Front View with EMC Plate

mm
in.

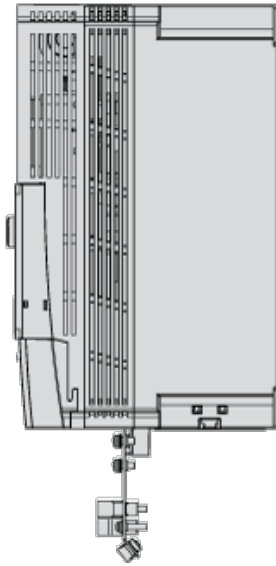

mm
in.

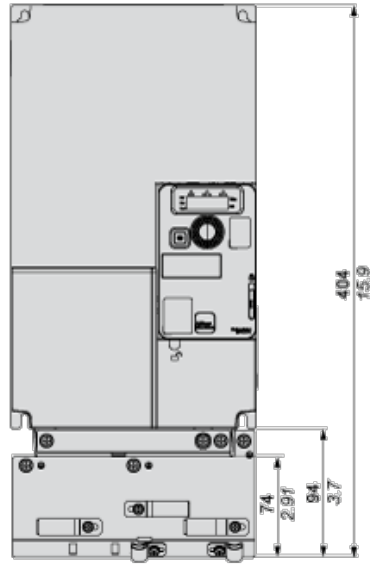

Mounting Types

Mounting Type A: Individual with Ventilation Cover

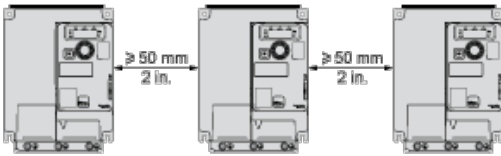

Only Possible at Ambient Temperature Less or Equal to 50 °C (122 °F)

Mounting Type B: Side by Side, Ventilation Cover Removed

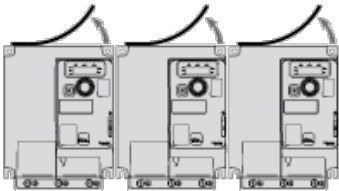

Mounting Type C: Individual, Ventilation Cover Removed

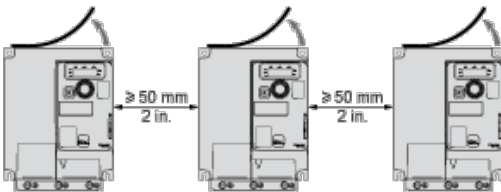

For Operation at Ambient Temperature Above 50 °C (122 °F)

Connection Diagrams

Diagram with Line Contactor

Connection diagrams conforming to standards ISO13849 category 1 and IEC/EN 61508 capacity SIL1, stopping category 0 in accordance with standard IEC/EN 60204-1.

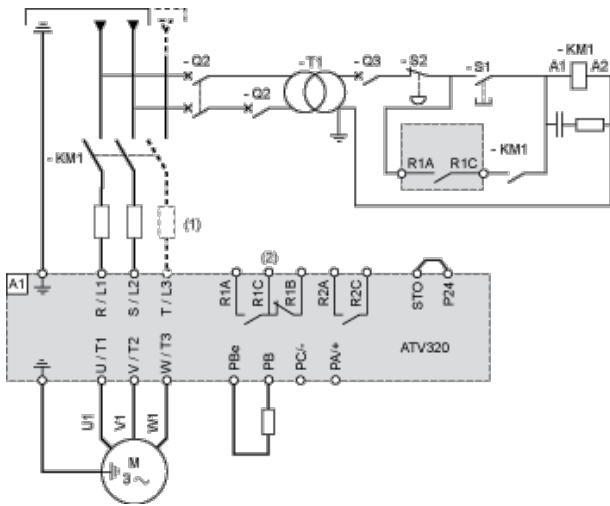

- (1) Line choke (if used)
- (2) Fault relay contacts, for remote signaling of drive status

Diagram with Switch Disconnect

Connection diagrams conforming to standards EN 954-1 category 1 and IEC/EN 61508 capacity SIL1, stopping category 0 in accordance with standard IEC/EN 60204-1.

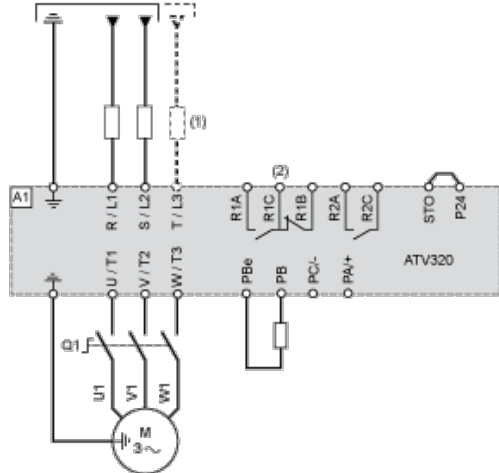

- (1) Line choke (if used)
- (2) Fault relay contacts, for remote signaling of drive status

Control Connection Diagram in Source Mode

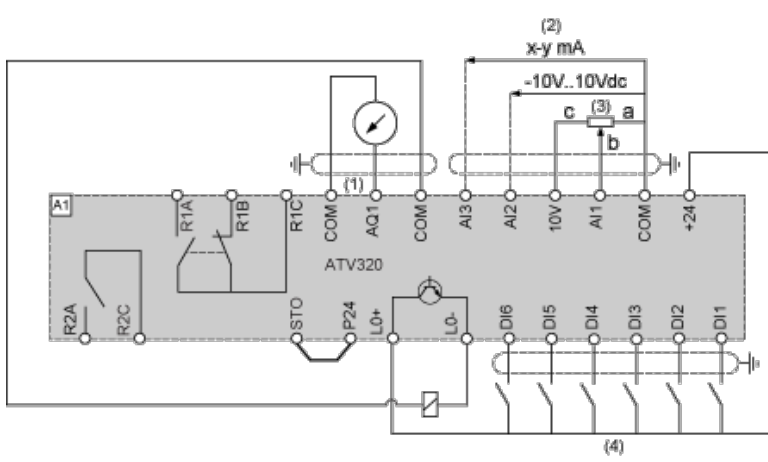

- (1) Analog output
- (2) Analog inputs
- (3) Reference potentiometer (10 kOhm maxi)
- (4) Digital inputs

Digital Inputs Wiring

The logic input switch (SW1) is used to adapt the operation of the logic inputs to the technology of the programmable controller outputs.

Switch SW1 set to "Source" position and use of the output power supply for the DIs.

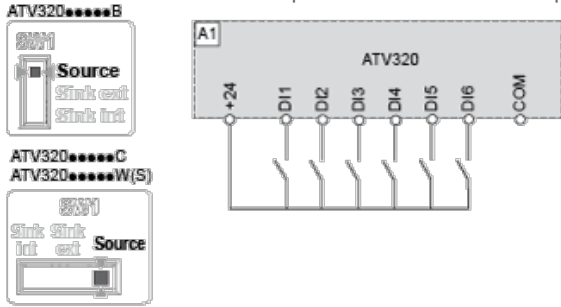

Switch SW1 set to "Source" position and use of an external power supply for the DIs.

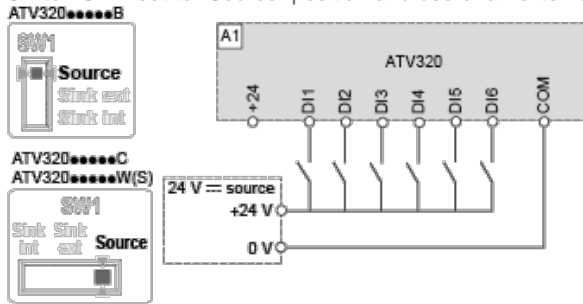

Switch SW1 set to "Sink Int" position and use of the output power supply for the DIs.

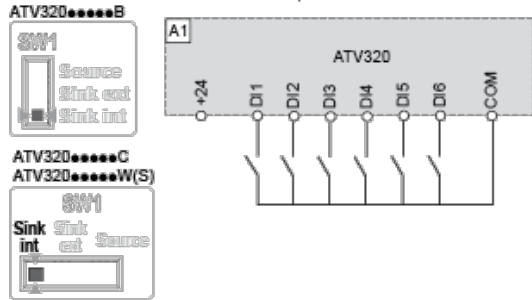

Switch SW1 set to "Sink Ext" position and use of an external power supply for the DIs.

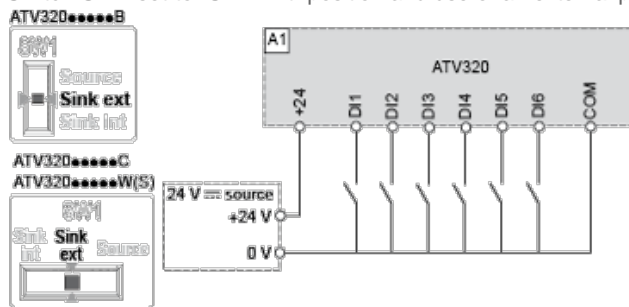

Derating Curves

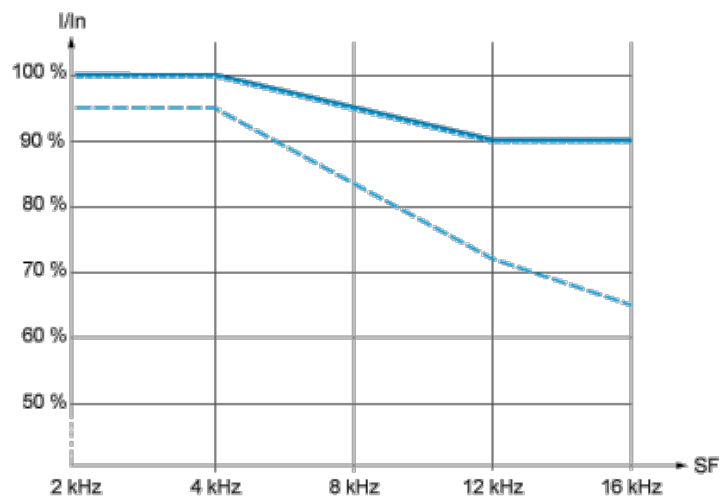

—— 40 °C (104 °F) - Mounting type A, B and C

..... 50 °C (122 °F) - Mounting type C

- - - - 60 °C (140 °F) - Mounting type C

In : Nominal Drive Current

SF : Switching Frequency