

**Dimensions: [mm]**

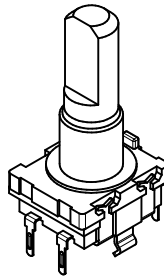

Scale - 1,2:1

**Recommended Hole Pattern: [mm]**

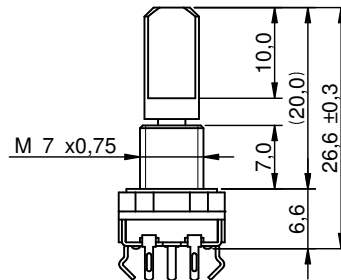
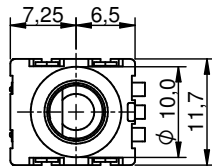
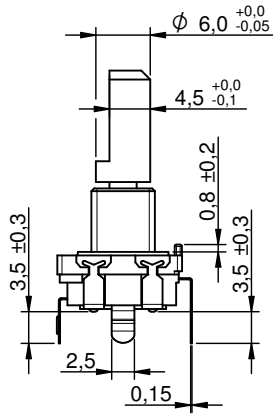
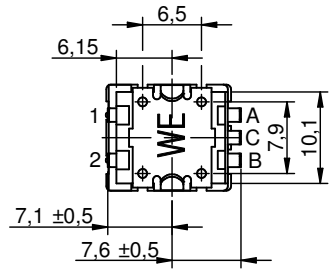
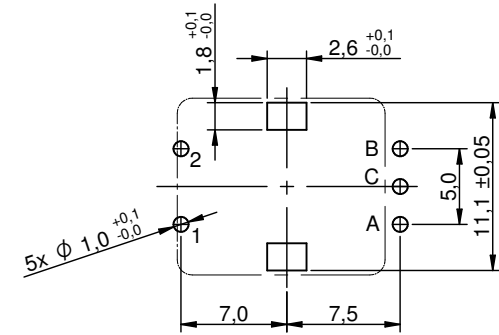

Scale - 2:1

**Schematic:**

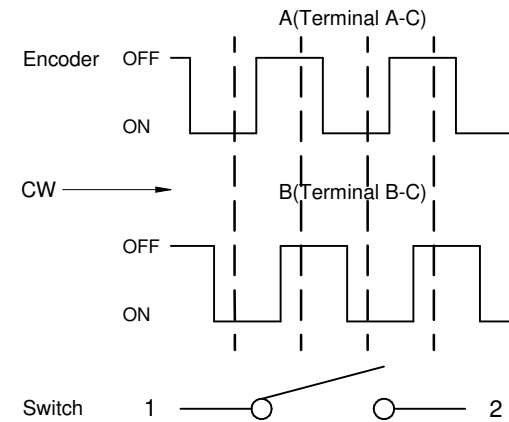

Würth Elektronik eiSos GmbH & Co. KG  
EMC & Inductive Solutions

Max-Eyth-Str. 1  
74638 Waldenburg  
Germany  
Tel. +49 (0) 79 42 945 - 0

www.we-online.com  
eiSos@we-online.com



CREATED DaSc	CHECKED MTH	GENERAL TOLERANCE DIN ISO 2768-1m	PROJECTION METHOD 
DESCRIPTION <b>WS-ENTV Mechanical Incremental Encoder Switch 11.7 x 13.75 x 26.6 mm Shaft with bushing</b>		ORDER CODE <b>482016514001</b>	
REVISION 001.000	STATUS Valid	DATE (YYYY-MM-DD) 2018-10-30	BUSINESS UNIT eiCan
		PAGE 1/6	

## Material Properties:

Actuator Material	Aluminium Alloy
Cover Material	Zinc Alloy
Bracket Material	Tin plate
Bracket Plating	Tin
Moveable Contact Material	POM
Moveable Contact Flammability	UL94 HB
Moveable Contact Color	White
Moveable Contact Material	Copper Alloy
Moveable Contact Plating	Silver
Frame Material	PBT
Frame Flammability Rating	UL94 HB
Frame Color	Black
Terminal Material	Copper Alloy
Terminal Plating	Silver

## Electrical Properties:

Properties		Test conditions	Value	Unit	Tol.
Rated Current	$I_R$		10	mA	
Rated Voltage	$U_R$		5	V (DC)	
Bounce Encoder			2	ms	max.
Sliding Noise Encoder			2	ms	max.
Contact Resistance Initial	R	for Switch	100	mΩ	max.
Contact Resistance After Life Test	R	for Switch	300	mΩ	max.
Bounce		for Switch	10	ms	max.
Insulation Resistance	$R_{ISO}$	250 V (DC)	100	MΩ	min.
Withstanding Voltage		1 min	300	V (AC)	

## Mechanical Properties:



Properties	Value	Unit	Tol.
Torque Encoder	200	gf.cm	max.
Resolution	15	Pulse/360°	
Detent	30	Positions	
Operation Force	600	g	+400/-300
Travel	0.5	mm	+0.4/-0.3
Electrical Life Encoder	15000	Cycles	
Electrical Life Switch	20000	Times	

## General Information:

Operating Temperature	-40 up to +85 °C
Storage Conditions (in original packaging)	< 40 °C ; < 75 % RH
Moisture Sensitivity Level (MSL)	1

## Packaging Properties:

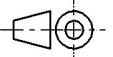
Properties	Value
Packaging	Tray
Packaging Unit	Qty. 100

Würth Elektronik eiSos GmbH & Co. KG EMC & Inductive Solutions  Max-Eyth-Str. 1 74638 Waldenburg Germany Tel. +49 (0) 79 42 945 - 0  www.we-online.com eiSos@we-online.com		CREATED DaSc	CHECKED MTH	GENERAL TOLERANCE DIN ISO 2768-1m	PROJECTION METHOD 
DESCRIPTION <b>WS-ENTV Mechanical Incremental Encoder Switch 11.7 x 13.75 x 26.6 mm Shaft with bushing</b>			ORDER CODE <b>482016514001</b>		
		REVISION 001.000	STATUS Valid	DATE (YYYY-MM-DD) 2018-10-30	BUSINESS UNIT eiCan
				PAGE 2/6	

## Classification Wave Soldering Profile:



## Classification Wave Soldering Profile:

Profile Feature		Pb-Free Assembly	Sn-Pb Assembly
Preheat Temperature Min <sup>1)</sup>	$T_{s \min}$	100 °C	100 °C
Preheat Temperature Typical	$T_{s \text{ typical}}$	120 °C	120 °C
Preheat Temperature Max	$T_{s \max}$	130 °C	130 °C
Preheat Time $t_s$ from $T_{s \min}$ to $T_{s \max}$	$t_s$	70 seconds	70 seconds
Ramp-up Rate	$\Delta T$	150 °C max.	150 °C max.
Peak Temperature	$T_p$	250 °C - 260 °C	235 °C - 260 °C
Time of actual peak temperature	$t_p$	max. 10 seconds max. 5 seconds each wave	max. 10 seconds max. 5 seconds each wave
Ramp-down Rate, Min		~ 2 K/ second	~ 2 K/ second
Ramp-down Rate, Typical		~ 3.5 K/ second	~ 3.5 K/ second
Ramp-down Rate, Max		~ 5 K/ second	~ 5 K/ second
Time 25 °C to 25 °C		4 minutes	4 minutes

<sup>1)</sup> refer to EN61760-1:2006  
 refer to EN61760-1:2006

Würth Elektronik eiSos GmbH & Co. KG  
 EMC & Inductive Solutions

Max-Eyth-Str. 1  
 74638 Waldenburg  
 Germany  
 Tel. +49 (0) 79 42 945 - 0

www.we-online.com  
 eiSos@we-online.com



CREATED DaSc	CHECKED MTH	GENERAL TOLERANCE DIN ISO 2768-1m	PROJECTION METHOD 
DESCRIPTION <b>WS-ENTV Mechanical Incremental Encoder Switch 11.7 x 13.75 x 26.6 mm Shaft with bushing</b>		ORDER CODE <b>482016514001</b>	
REVISION 001.000	STATUS Valid	DATE (YYYY-MM-DD) 2018-10-30	BUSINESS UNIT eiCan
		PAGE 3/6	

## Cautions and Warnings:

### The following conditions apply to all goods within the product series of Encoder switch of Würth Elektronik eiSos GmbH & Co. KG:

#### General:

- This mechanical component is designed and manufactured for use in general electronic equipment.
- Würth Elektronik must be asked for written approval (following the PPAP procedure) before incorporating the components into any equipment in fields such as military, aerospace, aviation, nuclear control, submarine, transportation (automotive control, train control, ship control), transportation signal, disaster prevention, medical, public information network, etc. where higher safety and reliability are especially required and/or if there is the possibility of direct damage or human injury.
- Mechanical components that will be used in safety-critical or high-reliability applications, should be pre-evaluated by the customer.
- The component is designed and manufactured to be used within the datasheet specified values. If the usage and operation conditions specified in the datasheet are not met, the switch, pins or termination may be damaged or dissolved.
- Do not drop or impact the components, as the switch, pins or termination may flake apart.
- Prevent any damage or scratches on the switch, especially on the actuator.
- Würth Elektronik products are qualified according to international standards, which are listed in each product reliability report. Würth Elektronik does not warrant any customer qualified product characteristics beyond Würth Elektronik's specifications, for its validity and sustainability over time.
- The responsibility for the applicability of the customer specific products and use in a particular customer design is always within the authority of the customer. All technical specifications for standard products also apply to customer specific products.

#### Product specific:

##### Soldering:

- The solder profile must comply with the Würth Elektronik technical soldering specification. All other profiles will void the warranty.
- All other soldering methods are at the customers' own risk.

##### Cleaning and Washing:

- If a series is washable, the general information section in the datasheet will contain the washability guidelines. Should there be no information regarding washability, the product has not been constructed to withstand a washing process. Washing agents used during the production to clean the customer application might damage or change the characteristics of the component, body, pins and/or termination. Washing agents may have a negative effect on the long-term functionality of the product.

If the parts are washable, hermetic:

- Cleaning agents used to clean the customers' applications, may damage or change the characteristics of the component, body, pins and termination.
- Please do not immerse any washable products into water or cleaning agents or put them in locations exposed to water completely.
- Do not clean washable series immediately after soldering. The cleaning agent may be absorbed into the switch through respiration while the switch cools.
- Please do not press actuator or change status /position during the cleaning and washing process.
- Using a brush during the cleaning process could deform function relevant areas. Therefore, we do not recommend using a brush during the PCB cleaning process.

##### Potting and Coating:



- If the product is potted in the customer application, the potting material may shrink or expand during and after hardening. Shrinking could lead to an incomplete seal, allowing contaminants into the body, pins or termination. Expansion could damage body, pins or termination. We recommend a manual inspection after potting or coating to avoid these effects.

#### Storage Conditions:

- A storage of Würth Elektronik products for longer than 12 months is not recommended. Within other effects, the terminals may suffer degradation, resulting in bad solderability. Therefore, all products shall be used within the period of 12 months based on the day of shipment.
- Do not expose the components to direct sunlight.
- The storage conditions in the original packaging are defined according to DIN EN 61760-2.
- If there is a moisture sensitive component, the storage condition in the original packaging is defined according to IPC/JEDEC-J-STD-033. It is also recommended to return the component to the original moisture proof bag and reseal the moisture proof bag again.

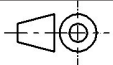

#### Handling:

1. The mechanical incremental encoder may experience bounce or chattering and sliding noise based on the operation speed and operation force. These possible behaviours should be considered during the design stage on customer side. The chattering and noise measurements are based on 1 rotation /second. The operation speed when manually operated, may have different outcome. In order to have proper use between firmware and encoder, please test the part under real conditions.
2. The phase difference value can vary by different rotation speed and force. Our measurement is based on 1 rotation/second. The operation speed when manually operated, may have different outcome. In order to have proper use between firmware and encoder, please test the part under real conditions.
3. Our encoder is not suitable for environments with high salt content or high moisture nor dew environments. Insulation deterioration or short circuits may occur.
4. Do not repeatedly operate the switch with excessive force. It may damage or deform the switch, which may result in malfunction of the switch.
5. Before setting the positions of the switch, one shall be sure that the PCB has cooled down.
6. In order to reduce the shifting of the actuator, side force shall be avoided.

Würth Elektronik eiSos GmbH & Co. KG EMC & Inductive Solutions  Max-Eyth-Str. 1 74638 Waldenburg Germany Tel. +49 (0) 79 42 945 - 0  www.we-online.com eiSos@we-online.com	CREATED DaSc	CHECKED MTH	GENERAL TOLERANCE DIN ISO 2768-1m	PROJECTION METHOD 	
	DESCRIPTION <b>WS-ENTV Mechanical Incremental Encoder Switch 11.7 x 13.75 x 26.6 mm Shaft with bushing</b>			ORDER CODE <b>482016514001</b>	
		REVISION 001.000	STATUS Valid	DATE (YYYY-MM-DD) 2018-10-30	BUSINESS UNIT eiCan

7. If the actuator is long, the rotation wobble increases in proportion to its length. To secure the quality of a set, we recommend use of the types with a bushing.
8. For products with switch function, we do not recommend to stack PCB's, in order to avoid malfunction of the switch.
9. In case a product requires particular handling precautions, in addition to the general recommendations mentioned here before, these will appear on the product datasheet.

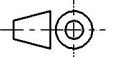
These cautions and warnings comply with the state of the scientific and technical knowledge and are believed to be accurate and reliable. However, no responsibility is assumed for inaccuracies or incompleteness.

Würth Elektronik eiSos GmbH & Co. KG EMC & Inductive Solutions  Max-Eyth-Str. 1 74638 Waldenburg Germany Tel. +49 (0) 79 42 945 - 0  www.we-online.com eiSos@we-online.com	CREATED DaSc	CHECKED MTH	GENERAL TOLERANCE DIN ISO 2768-1m	PROJECTION METHOD 
	DESCRIPTION <b>WS-ENTV Mechanical Incremental Encoder Switch 11.7 x 13.75 x 26.6 mm Shaft with bushing</b>			ORDER CODE <b>482016514001</b>
		REVISION 001.000	STATUS Valid	DATE (YYYY-MM-DD) 2018-10-30
			PAGE 5/6	

## Important Notes

The following conditions apply to all goods within the product range of Würth Elektronik eiSos GmbH & Co. KG:

### 1. General Customer Responsibility

Some goods within the product range of Würth Elektronik eiSos GmbH & Co. KG contain statements regarding general suitability for certain application areas. These statements about suitability are based on our knowledge and experience of typical requirements concerning the areas, serve as general guidance and cannot be estimated as binding statements about the suitability for a customer application. The responsibility for the applicability and use in a particular customer design is always solely within the authority of the customer. Due to this fact it is up to the customer to evaluate, where appropriate to investigate and decide whether the device with the specific product characteristics described in the product specification is valid and suitable for the respective customer application or not.

### 2. Customer Responsibility related to Specific, in particular Safety-Relevant Applications

It has to be clearly pointed out that the possibility of a malfunction of electronic components or failure before the end of the usual lifetime cannot be completely eliminated in the current state of the art, even if the products are operated within the range of the specifications. In certain customer applications requiring a very high level of safety and especially in customer applications in which the malfunction or failure of an electronic component could endanger human life or health it must be ensured by most advanced technological aid of suitable design of the customer application that no injury or damage is caused to third parties in the event of malfunction or failure of an electronic component. Therefore, customer is cautioned to verify that data sheets are current before placing orders. The current data sheets can be downloaded at [www.we-online.com](http://www.we-online.com).

### 3. Best Care and Attention

Any product-specific notes, cautions and warnings must be strictly observed. Any disregard will result in the loss of warranty.

### 4. Customer Support for Product Specifications

Some products within the product range may contain substances which are subject to restrictions in certain jurisdictions in order to serve specific technical requirements. Necessary information is available on request. In this case the field sales engineer or the internal sales person in charge should be contacted who will be happy to support in this matter.

### 5. Product R&D

Due to constant product improvement product specifications may change from time to time. As a standard reporting procedure of the Product Change Notification (PCN) according to the JEDEC-Standard inform about minor and major changes. In case of further queries regarding the PCN, the field sales engineer or the internal sales person in charge should be contacted. The basic responsibility of the customer as per Section 1 and 2 remains unaffected.

## 6. Product Life Cycle



Due to technical progress and economical evaluation we also reserve the right to discontinue production and delivery of products. As a standard reporting procedure of the Product Termination Notification (PTN) according to the JEDEC-Standard we will inform at an early stage about inevitable product discontinuance. According to this we cannot guarantee that all products within our product range will always be available. Therefore it needs to be verified with the field sales engineer or the internal sales person in charge about the current product availability expectancy before or when the product for application design-in disposal is considered. The approach named above does not apply in the case of individual agreements deviating from the foregoing for customer-specific products.

## 7. Property Rights

All the rights for contractual products produced by Würth Elektronik eiSos GmbH & Co. KG on the basis of ideas, development contracts as well as models or templates that are subject to copyright, patent or commercial protection supplied to the customer will remain with Würth Elektronik eiSos GmbH & Co. KG. Würth Elektronik eiSos GmbH & Co. KG does not warrant or represent that any license, either expressed or implied, is granted under any patent right, copyright, mask work right, or other intellectual property right relating to any combination, application, or process in which Würth Elektronik eiSos GmbH & Co. KG components or services are used.

## 8. General Terms and Conditions

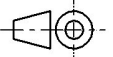
Unless otherwise agreed in individual contracts, all orders are subject to the current version of the "General Terms and Conditions of Würth Elektronik eiSos Group", last version available at [www.we-online.com](http://www.we-online.com).

Würth Elektronik eiSos GmbH & Co. KG EMC & Inductive Solutions  Max-Eyth-Str. 1 74638 Waldenburg Germany Tel. +49 (0) 79 42 945 - 0  <a href="http://www.we-online.com">www.we-online.com</a> <a href="mailto:eiSos@we-online.com">eiSos@we-online.com</a>	CREATED DaSc	CHECKED MTH	GENERAL TOLERANCE DIN ISO 2768-1m	PROJECTION METHOD 
	DESCRIPTION <b>WS-ENTV Mechanical Incremental Encoder Switch 11.7 x 13.75 x 26.6 mm Shaft with bushing</b>			ORDER CODE <b>482016514001</b>
		REVISION 001.000	STATUS Valid	DATE (YYYY-MM-DD) 2018-10-30
			PAGE 6/6	