



Bushless version

FEATURES

- Carbon resistive element.
- IP54 protection according to IEC 60529.
- Polyester substrate.
- Modular gang type (up to 4).
- Self extinguishable material UL 94-V0.
- Upon request:
 - Metallic support.
 - Stereo matching.
 - Switch.
 - Nut & washer.
 - Bushless & shaftless models.
 - Assemblies with wires and connectors.

MECHANICAL SPECIFICATIONS

- Mechanical rotation angle: $300^\circ \pm 5^\circ$
- Electrical rotation angle: $280^\circ \pm 20^\circ$
- Torque: 0.5 to 1.5 Ncm. (0.7 to 2.1 in-oz)
- Stop torque: > 40 Ncm. (>56 in-oz)
- Max. torque nut (binding out): < 80 Ncm. (112 in-oz)
- Thrust and pull in the shaft: > 25 N

* Others check availability.

** Up to 85°C depending on application.

ELECTRICAL SPECIFICATIONS

- Range of values*
 $100\Omega \leq R_n \leq 5\text{ M}$ (Decad. 1.0 - 2.0 - 2.2 - 2.5 - 4.7 - 5.0)
- Standard tolerance*: $100\Omega \leq R_n \leq 1\text{M}\Omega$ $\pm 20\%$
 $1\text{M}\Omega < R_n \leq 5\text{M}\Omega$ $\pm 30\%$
- Max. Voltage: 250 VDC (lin) 125 VDC (no lin)
- Nominal Power 50°C (122°F) (see power rating curve)
 0.2 W (lin) 0.1 W (no lin)
- Taper* Lin ; Log; Alog (Log. & Alog. only $R_n \geq 1\text{K}$).
- Residual resistance*: $\leq 0.5\% R_n$ (5 Ω min.)
- Equivalent Noise Resistance: $\leq 3\% R_n$ (3 Ω min.)
- Operating temperature**: $-25^\circ\text{C} + 70^\circ\text{C}$ ($-13^\circ\text{F} + 158^\circ\text{F}$)

HOW TO ORDER



NOTES:

- (1) Mounting style: Type "V" is only available in model "S" potentiometer and with printed circuit terminals.
- (2) Bushings: Type "10" has two parallel flat surfaces for avoiding rotation. Bushless option only available for single model.
- (3) M07 shaft is only available with M10 bushing. --- = no shaft
- (4) Value:
 - Code: 10 1 100 Ω
 - Number of zeros
 - 2 first digits of the value.
 - In models "D", "T", "C", with different values, they will be asked by drawings.
- (5) Tolerance (non standard), upon request. Example: +7% Code: 07 05
 -5%
- (6) Shaft special length:
 - Only for special length and plain shafts (not knurled). Example: Shaft $\varnothing 6.35$ L = 24.5 M07 24.5
 - NOTE: Maximum length recommended: L = 45
 - special length shafts
- (7) Mounting brackets: Only applicable for model "S", mounting "H" and without switch.
- (8) Stereo matching: not available for single models. Maximum will be: •3dB for model "D" •4dB for model "T" •6dB for model "C"
- (9) Not available for Bushless version.
- (10) Switch option not available with antilog taper.

HOW TO ORDER CUSTOM DRAWING

PC-16 S V + DRAWING NUMBER (Max. 16 digits)

This way of ordering should be used for options which are not included in the "How to order" standard and optional extras.

STANDARD OPTIONS

Shaft length 0 Standard Length
 Mounting brackets Without mounting brackets
 Stereo matching Only on request (see note 8)
 Switch No switch
 Nut & washer Without nut and washer

MODELS



PC-16 S/D/T/C..H...

PC-16 SV

METALLIC SUPPORT

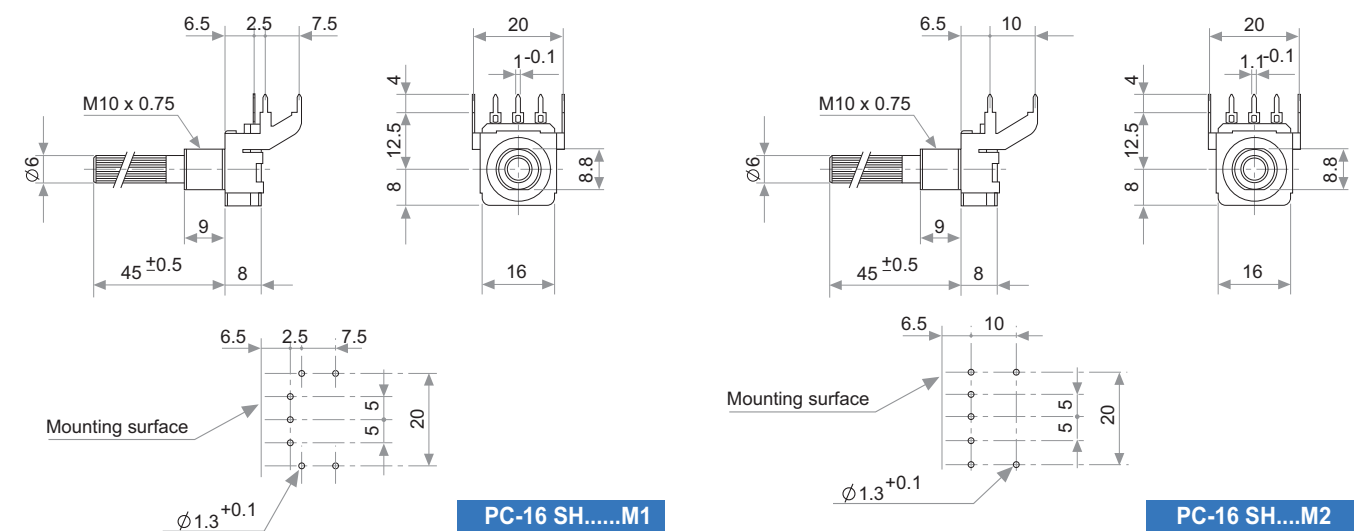

PC-16 SH.....M1

PC-16 SH....M2

BUSHINGS

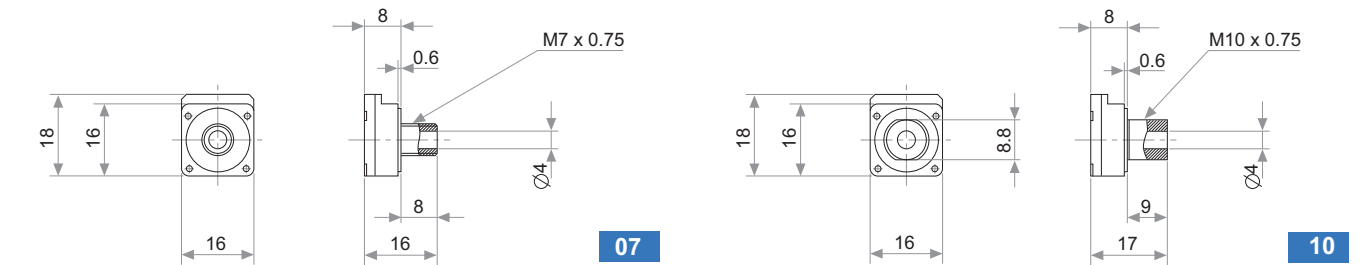

07

10

EXAMPLES OF BUSHLESS VERSION

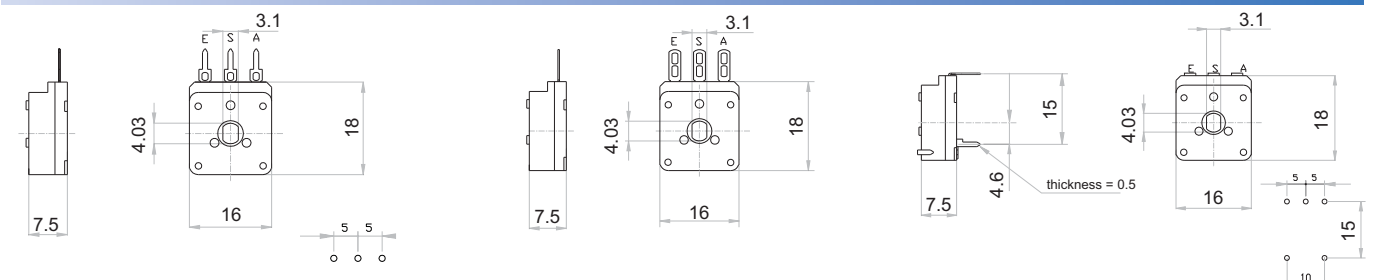

Download STEP files here:
<https://piher.net/piher/?p=938>

TERMINALS

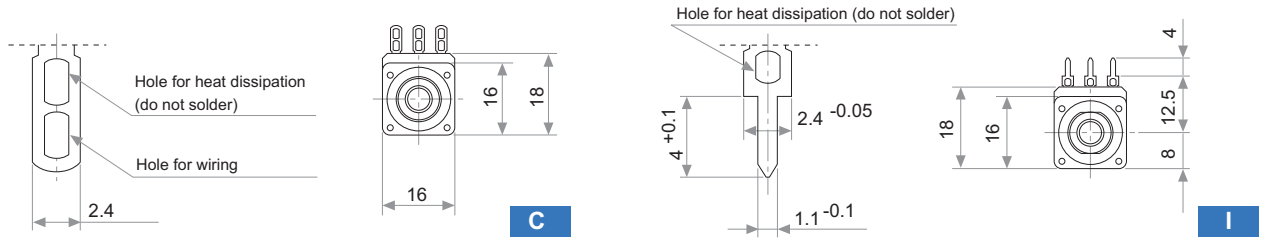

TAPERS

Standard

A = Linear
B = Log.
C = Alog.

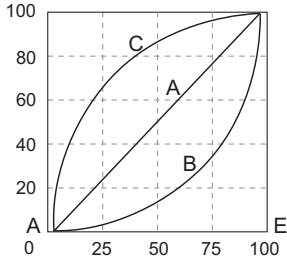

POWER RATING CURVE



NUTS & WASHERS

Bushing 10

Bushing 07



NOTE = Please note relative terminal positions when ordering non linear tapers.

TESTS

TYPICAL VARIATIONS

TESTS		TYPICAL VARIATIONS
ELECTRICAL LIFE	1.000 h. @ 50°C; 0.2 W	±5 %
MECHANICAL LIFE : POT.* SWITCH	25.000 (10-15 CPM) 10.000 (1 A, 50 VAC)	±3 % (Rn < 1 MΩ)
TEMPERATURE COEFFICIENT	-25°C; +70°C	±300 ppm/°C (Rn < 100 KΩ)
THERMAL CYCLING	16 h. @ 85°C; 2h. @ -25°C	±2.5 %
DAMP HEAT	500 h. @ 40°C @ 95% HR	±5 %
VIBRATION (for each plane X,Y,Z)	2 h. @ 10 Hz. ... 55 Hz.	±2 %

(*) only applicable to values ≥1K. For lower values please consult.

SWITCH



SWITCH SPECIFICATIONS

NOMINAL CURRENT	1A, 250 VAC
CONTACT RESISTANCE (initial)	10 m Ω
OPERATING TORQUE	1 to 3 Ncm (1.4 to 4.2 in oz)
OPERATING ANGLE	30° \pm 5°
TEST VOLTAGE	500 V

PACKAGING

Boxes of 100 pieces (single body model): Inner dimensions 250 x 160 x 95 mm

METALIC SHAFTS

STANDARD



A	L	CODE
4	45	M04
6	45	M06
6.35	45	M07



A	B	C	L	CODE
2	5	7	15	M11
2	10	11	20	M12
4	12	14	25	M13
4	12	14	30	M14
4	12	14	35	M15
4	12	14	40	M16
4	12	14	45	M17

SPECIAL



A
Ø 4
Ø 6
Ø 6.35

PLASTIC SHAFTS Ø3.1



P09

PLASTIC SHAFTS Ø4

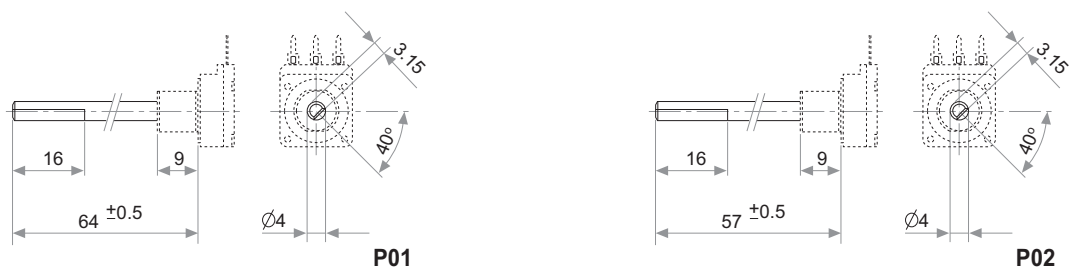

P01

P02

PLASTIC SHAFTS Ø4



PLASTIC SHAFTS Ø6

Shaft position shown full CCW. Any other position for plastic shafts has to be shifted n times 24° . Other positions upon request.



Special shaft example (18 teeth knurl & arrow. Check availability.).



OPEN CIRCUIT FEATURE (CUT TRACK)



CCW on-off (A)

PCI
Cut track at the beginning of the travel.

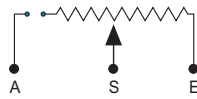

PCF
Cut track at the end of the travel.

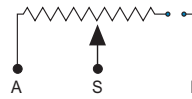

CW on-off (E)

A = Initial S = Wiper E = Final.

PCI, PCF and other configurations available upon request. Check the ordering code with Piher.

RECOMMENDED CONNECTIONS

Piher potentiometer's recommended connection circuit for a position sensor or control application. (voltage divider circuit electronic design).



Disclaimer

The product information in this catalogue is for reference purposes. Please consult for the most up to date and accurate design information.

Piher Sensors & Controls S.A., its affiliates, agents, and employees, and all persons acting on its or their behalf (collectively, "Piher"), disclaim any and all liability for any errors, inaccuracies or incompleteness contained herein or in any other disclosure relating to any product described herein.

Piher disclaims any and all liability arising out of the use or application of any product described herein or of any information provided herein to the maximum extent permitted by law. The product specifications do not expand or otherwise modify Piher's terms and conditions of sale, including but not limited to the warranty expressed therein, which apply to these products.

No licence, express or implied, by estoppel or otherwise, to any intellectual property rights is granted by this document or by any conduct of Piher.

The products shown herein are not designed for use in medical, life-saving, or life-sustaining applications unless otherwise expressly indicated. Customers using or selling Piher products not expressly indicated for use in such applications do so entirely at their own risk and agree to fully indemnify Piher for any damages arising or resulting from such use or sale. Please contact authorised Piher personnel to obtain written terms and conditions regarding products designed for such applications.

Product names and markings noted herein may be trademarks of their respective owners.

Information contained in and/or attached to this catalogue may be subject to export control regulations of the European Community, USA, or other countries. Each recipient of this document is responsible to ensure that usage and/or transfer of any information contained in this document complies with all relevant export control regulations. If you are in any doubt about the export control restrictions that apply to this information, please contact the sender immediately. For any Piher International Corp. Exports, Note: All products / technologies are EAR99 Classified commodities. Exports from the United States are in accordance with the Export Administration Regulations. Diversion contrary to US law is prohibited.

Piher is an Amphenol™ company.



Note: Piher products can be adapted to meet customer's requirements. Due to continuous process improvement, specifications are subject to change without notice.

v180220

Contact

Piher Sensors & Controls SA
Polígono Industrial Municipal
Vial T2, 22,
31500 Tudela - Spain.
t. +34-948-820450
f. +34-948-824050

sales@piher.net

www.piher.net