

## Commercial Miniature 9mm Encoders

### Features

- Miniature 9mm style
- 2 bit quadrature (Graycode)
- Optional momentary switch
- Continuous rotation
- Durable metal shaft
- Available with 16 or 20 detents
- RoHS compliant



## Electrical and Mechanical Specifications

### Encoder Ratings :

**Contact Resistance**  
1Ω maximum

**Voltage Rating (each channel)**  
12 VDC @ 10 mA maximum.  
5 VDC @ 1 mA minimum.

**Phase Difference (FIG.1)**  
T1,T2,T3,T4 —2 milliseconds min for 20 pulse encoder.  
- 8 milliseconds min for 8 pulse encoder.

**Contact Bounce / Chatter (FIG.3)**  
t1, t2, t3 - 3 milliseconds max.

**Detent Points**  
16 or 20 detents available

**Rotational Life**  
50,000 cycles

**Resolution**  
8 or 20 pulses in 360°

**Insulation Resistance**  
100 megohms between all terminals & bushing at 250 VDC

**Temperature Ratings**  
Operation: - 30°C to +70°C

### **Solderability**

Flux for 5 - 10 sec., then dip into a solder bath at 260 ±5°C for 3 sec.

### **Pull and Thrust on Shaft**

Withstand a pushing or pulling force of 10 kg-f static load applied in axial direction for 10 ±1 sec. without physical damage or electrical degradation.

### Momentary SPST Switch Ratings :

**Switch Contact Resistance**  
100 mΩ maximum initial, 200mΩ after life cycles

**Switch Rating**  
16 VDC @ 10mA min. to 0.5A max.

**Switch Bounce**  
5 milliseconds maximum

**Switch Operating Force**  
600 ±300 grams (21 ±11oz) for 0.5mm (.020") travel

**Switch Life**  
100,000 operations for 0.5mm (.020") travel

**Switch Travel**  
0.5mm (.020")

# TYPE MC-290V Typical 2-Bit Encoder With Momentary Switch, Shaft Perpendicular to PC Board

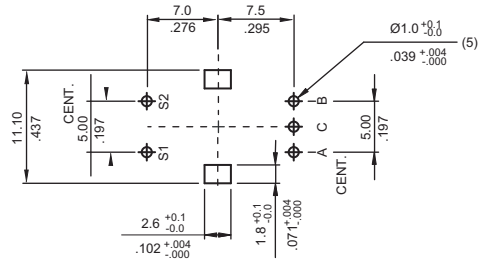
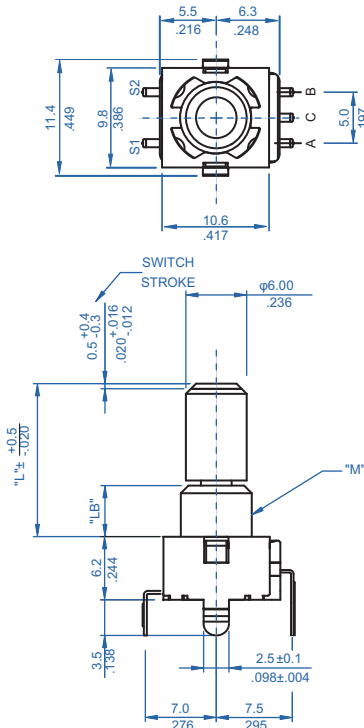

MOUNTING HOLE DETAIL VIEWED FROM MOUNTING SIDE

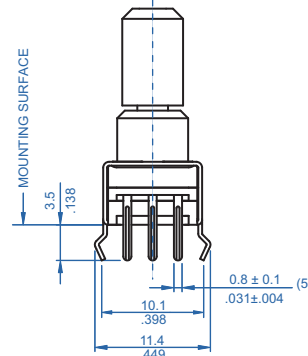

DIMENSION:  $\frac{\text{mm}}{\text{inch}}$

20 PPR OUTPUT SIGNAL (FIG.1.1)

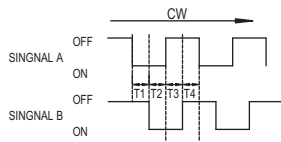

8 PPR OUTPUT SIGNAL (FIG.1.2)

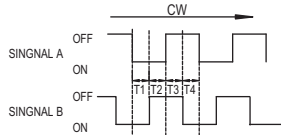

PHASE DIFFERENCE

TYPICAL CIRCUIT (FIG.2)

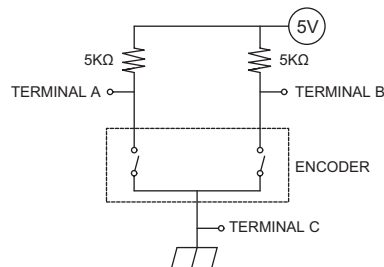

BOUNCE / CHATTER (FIG.3)

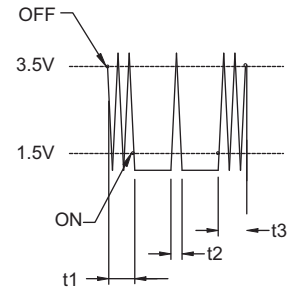

## Shaft Trim

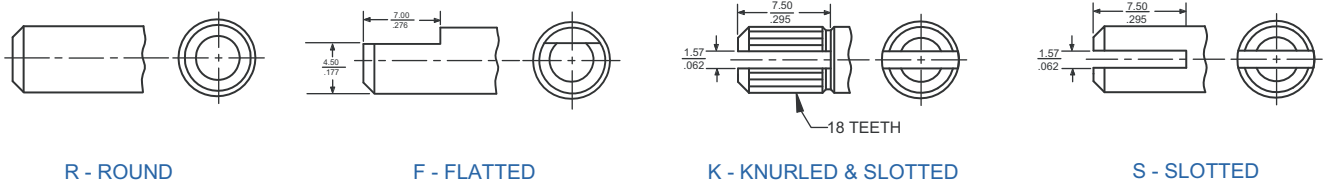

DIMENSION:  $\frac{\text{mm}}{\text{inch}}$

## Ordering Information



**Output Combinations :**  
 8 PPR with 0 or 16 Detents  
 20 PPR with 0 or 20 Detents

Consult CTS for other available options not listed

# Mouser Electronics

Authorized Distributor

Click to View Pricing, Inventory, Delivery & Lifecycle Information:

[CTS:](#)

[290VAA5F201A1](#) [290VAA5F201A2](#) [290VAA5F201B1](#) [290VAA5F201B2](#) [290VAB0R201A1](#) [290VAB0R201A2](#)  
[290VAB0R201B1](#) [290VAB0R201B2](#) [290VAB0F201A2](#) [290VAB0F201B2](#) [290VBA5F081B3](#)