

# G3VM-61GR2

MOS FET Relays

## MOS FET Relays with 1.7-A switching Designed for Switching Minute Signals and Analog Signals.

- Continuous load current of 1.7 A.

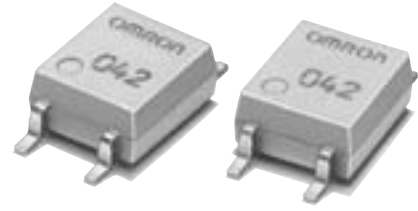

Note: The actual product is marked differently from the image shown here.

RoHS compliant

### Application Examples

- Semiconductor test equipment
- Test & Measurement equipment
- Communication equipment
- Data loggers

### Terminal Arrangement/Internal Connections

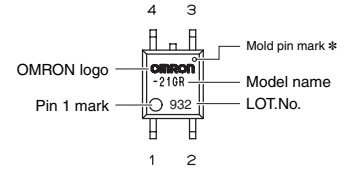
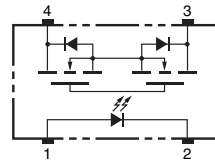

Note: The actual product is marked differently from the image shown here.  
\* The indentation in the corner diagonally opposite from the pin 1 mark is from a pin on the mold.

### List of Models

Package type	Contact form	Terminals	Load voltage (peak value) *	Model	Minimum package quantity	
					Number per tube	Number per tape and reel
SOP4	1a (SPST-NO)	Surface-mounting Terminals	60 V	G3VM-61GR2	100	-
				G3VM-61GR2 (TR05)	-	500

\* The AC peak and DC value are given for the load voltage.

### Absolute Maximum Ratings (Ta = 25°C)

Item	Symbol	Rating	Unit	Measurement conditions	
Input	LED forward current	IF	30	mA	
	LED forward current reduction rate	$\Delta I_F / ^\circ C$	-0.3	mA/ $^\circ C$	Ta $\geq 25^\circ C$
	LED reverse voltage	VR	5	V	
	Connection temperature	TJ	125	$^\circ C$	
Output	Load voltage (AC peak/DC)	V <sub>OFF</sub>	60	V	
	Continuous load current (AC peak/DC)	Io	1.7	A	
	ON current reduction rate	$\Delta I_o / ^\circ C$	-17	mA/ $^\circ C$	Ta $\geq 25^\circ C$
	Pulse ON current	Iop	5	A	t = 100 ms, Duty = 1/10
Connection temperature	TJ	125	$^\circ C$		
Dielectric strength between I/O (See note 1.)	V <sub>I-O</sub>	1500	V <sub>rms</sub>	AC for 1 min	
Ambient operating temperature	Ta	-40 to +85	$^\circ C$	With no icing or condensation	
Ambient storage temperature	T <sub>stg</sub>	-55 to +125	$^\circ C$	With no icing or condensation	
Soldering temperature	-	260	$^\circ C$	10 s	

Note: 1. The dielectric strength between the input and output was checked by applying voltage between all pins as a group on the LED side and all pins as a group on the light-receiving side.

### Electrical Characteristics (Ta = 25°C)

Item	Symbol	Minimum	Typical	Maximum	Unit	Measurement conditions	
Input	LED forward voltage	V <sub>F</sub>	1.18	1.33	1.48	V	I <sub>F</sub> = 10 mA
	Reverse current	I <sub>R</sub>	-	-	10	$\mu A$	V <sub>R</sub> = 5 V
	Capacity between terminals	C <sub>T</sub>	-	70	-	pF	V = 0, f = 1 MHz
	Trigger LED forward current	I <sub>FT</sub>	-	0.6	3	mA	I <sub>o</sub> = 100 mA
	Turn-OFF LED forward current	I <sub>FC</sub>	0.1	-	-	mA	I <sub>OFF</sub> = 100 $\mu A$
Output	Maximum resistance with output ON	R <sub>ON</sub>	-	0.08	0.13	$\Omega$	I <sub>F</sub> = 5 mA, I <sub>o</sub> = 1.7 A, t < 1 s
	Current leakage when the relay is open	I <sub>LEAK</sub>	-	1	10	nA	V <sub>OFF</sub> = 60 V
	Capacity between terminals	C <sub>off</sub>	-	250	-	pF	V = 0, f = 1 MHz
	Capacity between I/O terminals	C <sub>I-O</sub>	-	0.8	-	pF	f = 1 MHz, V <sub>s</sub> = 0 V
	Insulation resistance between I/O terminals	R <sub>I-O</sub>	1000	10 <sup>8</sup>	-	M $\Omega$	V <sub>I-O</sub> = 500 VDC, RoH $\leq 60\%$
Turn-ON time	t <sub>ON</sub>	-	0.7	3	ms	I <sub>F</sub> = 5 mA, R <sub>L</sub> = 200 $\Omega$	
Turn-OFF time	t <sub>OFF</sub>	-	0.1	0.5	ms	V <sub>DD</sub> = 20 V (See note 2.)	

Note: 2. Turn-ON and Turn-OFF Times

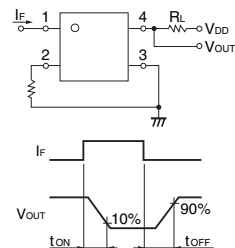

## Recommended Operating Conditions

For usage with high reliability, Recommended Operation Conditions is a measure that takes into account the derating of Absolute Maximum Ratings and Electrical Characteristics. Each item on this list is an independent condition, so it is not simultaneously satisfy several conditions.

Item	Symbol	Minimum	Typical	Maximum	Unit
Load voltage (AC peak/DC)	V <sub>DD</sub>	-	-	48	V
Operating LED forward current	I <sub>F</sub>	5	10	25	mA
Continuous load current (AC peak/DC)	I <sub>O</sub>	-	-	1.3	A
Ambient operating temperature	T <sub>a</sub>	-20	-	65	°C

## Engineering Data

LED forward current vs. Ambient temperature

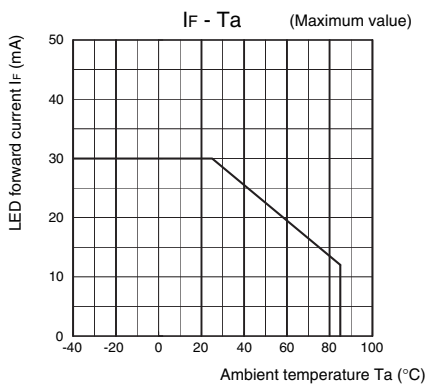

Continuous load current vs. Ambient temperature

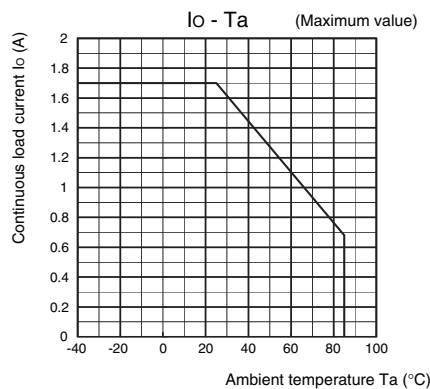

LED forward current vs. LED forward voltage

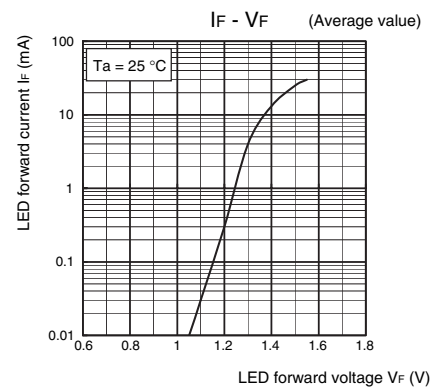

Continuous load current vs. On-state voltage

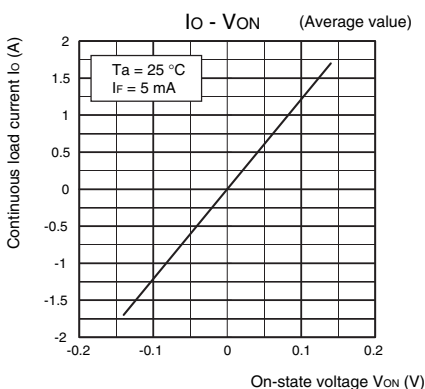

On-state resistance vs. Ambient temperature

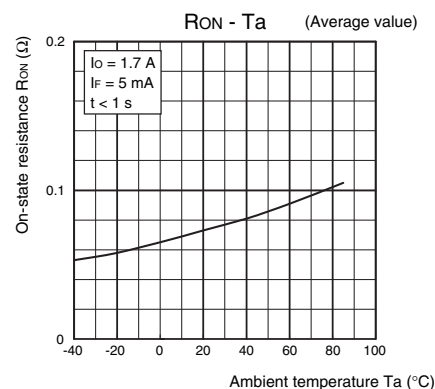

Trigger LED forward current vs. Ambient temperature

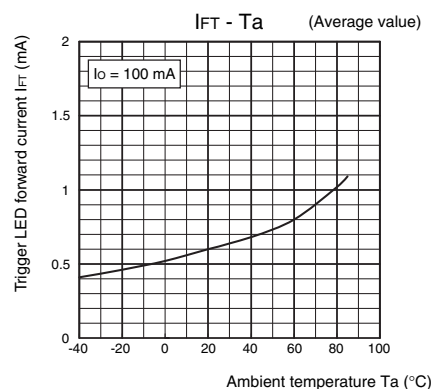

Turn ON, Turn OFF time vs. LED forward current

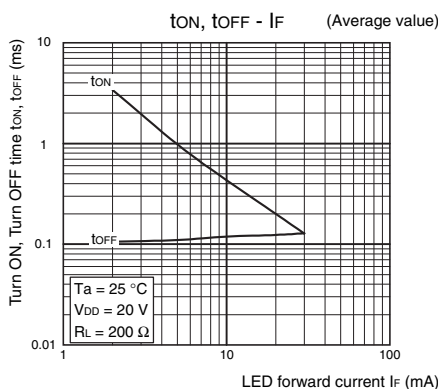

Turn ON, Turn OFF time vs. Ambient temperature

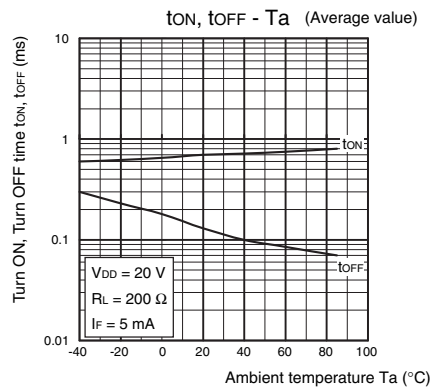

Current leakage vs. Ambient temperature

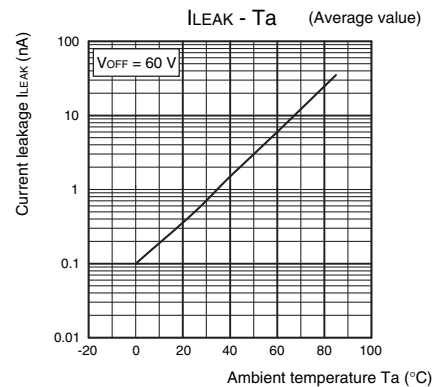

## Safety Precautions

- Refer to "Common Precautions" for all G3VM models.

## ■ Appearance

### SOP (Small Outline Package)

SOP4

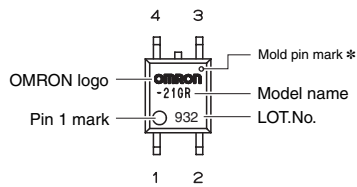

Note: The actual product is marked differently from the image shown here.

\* The indentation in the corner diagonally opposite from the pin 1 mark is from a pin on the mold.

## ■ Dimensions

(Unit: mm)



### Surface-mounting Terminals

Weight: 0.1 g

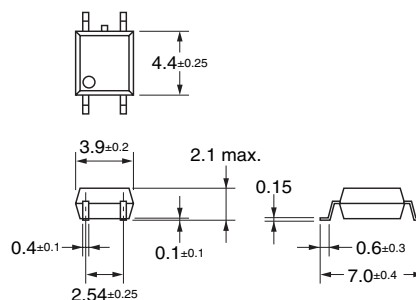

### Actual Mounting Pad Dimensions

(Recommended Value, TOP VIEW)

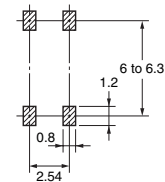

Note: The actual product is marked differently from the image shown here.

- Application examples provided in this document are for reference only. In actual applications, confirm equipment functions and safety before using the product.
- Consult your OMRON representative before using the product under conditions which are not described in the manual or applying the product to nuclear control systems, railroad systems, aviation systems, vehicles, combustion systems, medical equipment, amusement machines, safety equipment, and other systems or equipment that may have a serious influence on lives and property if used improperly. Make sure that the ratings and performance characteristics of the product provide a margin of safety for the system or equipment, and be sure to provide the system or equipment with double safety mechanisms.

Note: Do not use this document to operate the Unit.

# Mouser Electronics

Authorized Distributor

Click to View Pricing, Inventory, Delivery & Lifecycle Information:

Omron:

[G3VM-61GR2](#) [G3VM-61GR2\(TR05\)](#)