

Product Overview

The Qorvo TGF2977-SM is a 5 W (P_{3dB}) discrete GaN on SiC HEMT which operates from DC to 12 GHz and 32 V supply. The device is in an industry standard overmolded package and is ideally suited for avionics, military, marine and weather radar. The device can support pulsed and linear operations.

Lead-free and ROHS compliant.

Evaluation boards are available upon request.

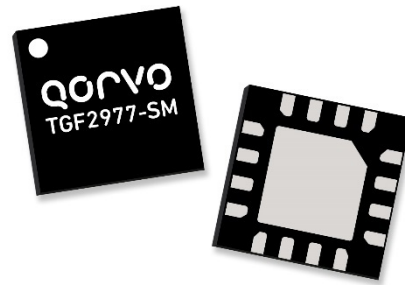

3 x 3mm Package

Functional Block Diagram

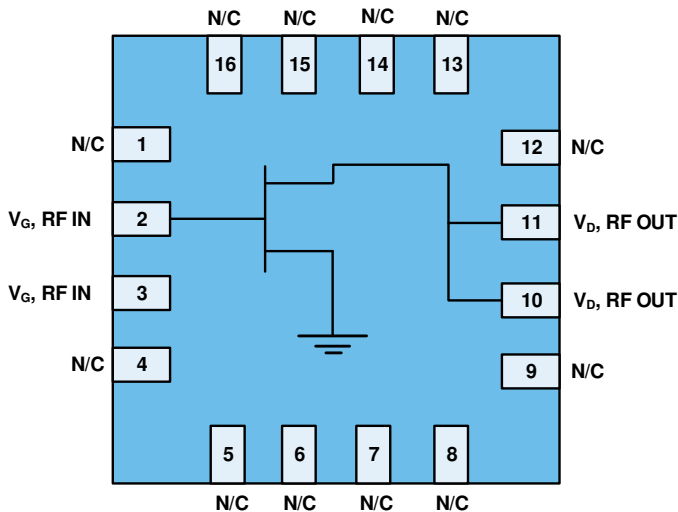

Key Features

- Frequency: DC to 12 GHz
 - Output Power (P_{3dB})¹: 4.8 W
 - Linear Gain¹: 13 dB
 - Typical PAE_{3dB}¹: 50%
 - Operating Voltage: 32 V
 - CW and Pulse capable
- Note 1: @ 9 GHz Load Pull

Applications

- Military radar
- Commercial radar
 - Avionics
 - Marine
 - Weather

Ordering info

Part No.	ECCN	Description
TGF2977-SM	EAR99	QFN Packaged Part
TGF2977-SMEVBP01	EAR99	9 – 10 GHz EVB
TGF2977-SMEVBP02	EAR99	2.6 – 4.2 GHz EVB

Absolute Maximum Ratings¹

Parameter	Rating	Units
Breakdown Voltage, BV_{DG}	+100	V
Gate Voltage Range, V_G	-7 to +2	V
Drain Current, $I_{D_{MAX}}$	0.6	A
Gate Current Range, I_G	See page 20.	mA
Power Dissipation, CW (P_{DISS})	9.3 ²	W
RF Input Power, CW, $T_{amb} = 25\text{ }^\circ\text{C}$	+30	dBm
Channel Temperature, T_{CH}	275	$^\circ\text{C}$
Mounting Temperature (30 Seconds)	320	$^\circ\text{C}$
Storage Temperature	-65 to +150	$^\circ\text{C}$

Notes:

1. Operation of this device outside the parameter ranges given above may cause permanent damage.
2. Device base temperature = 85 $^\circ\text{C}$.

Recommended Operating Conditions¹

Parameter	Min	Typ	Max	Units
Operating Temp. Range	-40	+25	+85	$^\circ\text{C}$
Drain Voltage Range, V_D		+32	+40	V
Drain Bias Current, I_{DQ}		25		mA
Drain Current, I_D^4	-	325	-	mA
Gate Voltage, V_G^3	-	-2.8	-	V
Channel Temperature (T_{CH})	-	-	225	$^\circ\text{C}$
Power Dissipation (P_D) ^{2,4}	-	-	9.2	W
Power Dissipation (P_D), CW ²	-	-	7.4	W

Notes:

1. Electrical performance is measured under conditions noted in the electrical specifications table. Specifications are not guaranteed over all recommended operating conditions.
2. Package base at 85 $^\circ\text{C}$
3. To be adjusted to desired I_{DQ}
4. Pulsed, 100uS PW, 20% DC

Measured Load Pull Performance – Power Tuned¹

Parameter	Typical Values						Units
	5	6	8	9	10	12	
Frequency, F	5	6	8	9	10	12	GHz
Drain Voltage, V_D	32	32	32	32	32	32	V
Drain Bias Current, I_{DQ}	25	25	25	25	25	25	mA
Output Power at 3dB compression, P_{3dB}	37.5	37.2	37.0	36.8	36.8	36.5	dBm
Power Added Efficiency at 3dB compression, PAE_{3dB}	52.0	56.3	51.1	45.8	41.7	31.8	%
Gain at 3dB compression, G_{3dB}	15.2	14.4	11.4	9.8	8.3	5.3	dB

Notes:

1. Pulsed, 100 uS Pulse Width, 20% Duty Cycle
2. Characteristic Impedance, $Z_o = 15\ \Omega$.

Measured Load Pull Performance – Efficiency Tuned¹

Parameter	Typical Values						Units
	5	6	8	9	10	12	
Frequency, F	5	6	8	9	10	12	GHz
Drain Voltage, V_D	32	32	32	32	32	32	V
Drain Bias Current, I_{DQ}	25	25	25	25	25	25	mA
Output Power at 3dB compression, P_{3dB}	37.2	36.3	35.7	36.0	35.5	36.1	dBm
Power Added Efficiency at 3dB compression, PAE_{3dB}	60.2	62.3	56.6	52.0	47.1	38.2	%
Gain at 3dB compression, G_{3dB}	15.5	14.8	12.0	10.4	8.9	5.8	dB

Notes:

1. Pulsed, 100 uS Pulse Width, 20% Duty Cycle
2. Characteristic Impedance, $Z_o = 15\ \Omega$.

9 – 10 GHz EVB 9.4 GHz Performance¹

Parameter	Min	Typ	Max	Units
Linear Gain, G_{LIN}	–	10.1	–	dB
Output Power at 3dB compression point, P3dB	–	3.6	–	W
Drain Efficiency at 3dB compression point, DEFF3dB	–	48.4	–	%
Gain at 3dB compression point, G3dB	–	7.1	–	dB

Notes:

1. $V_D = +32$ V, $I_{DQ} = 35$ mA, Temp = +25 °C, Pulse Width = 100 uS, Duty Cycle = 20%

RF Characterization – Mismatch Ruggedness at 9.4 GHz

Symbol	Parameter	dB Compression	Typical
VSWR	Impedance Mismatch Ruggedness	3	10:1

Test conditions unless otherwise noted: $T_A = 25$ and -40 °C, $V_D = 32$ V, $I_{DQ} = 35$ mA

Input drive power is determined at pulsed 3dB compression under matched condition at EVB output connector.

Measured Load-Pull Smith Charts^{1, 2}

Notes:

1. Test Conditions: $V_D = 32\text{ V}$, $I_{DQ} = 25\text{ mA}$, 100 μS Pulse Width, 20% Duty Cycle
2. See page 21 for load pull reference planes where the performance was measured.

5GHz, Load-pull

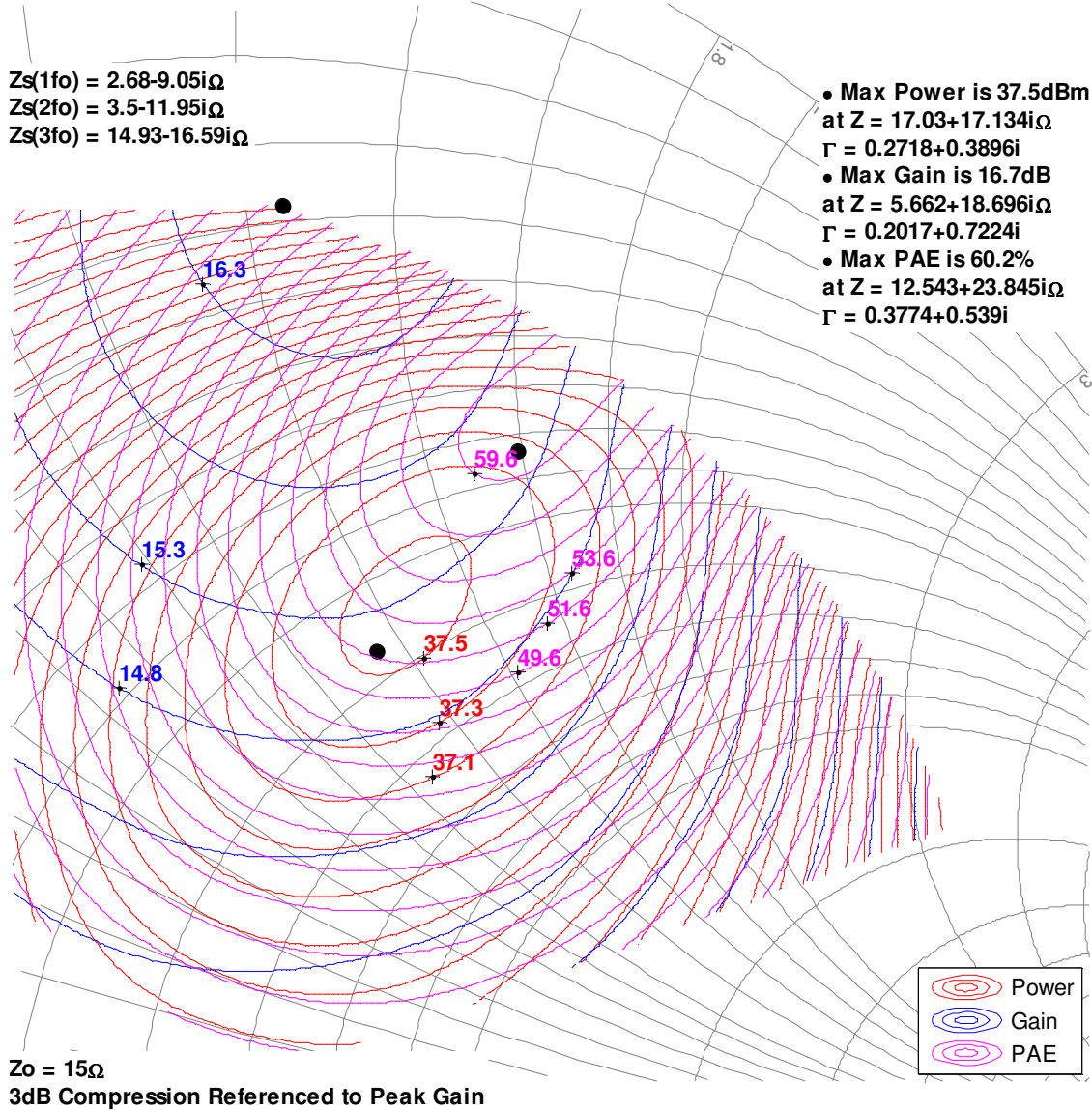

Measured Load-Pull Smith Charts^{1,2}

Notes:

1. Test Conditions: $V_D = 32\text{ V}$, $I_{DQ} = 25\text{ mA}$, 100 uS Pulse Width, 20% Duty Cycle
2. See page 21 for load pull reference planes where the performance was measured.

6GHz, Load-pull

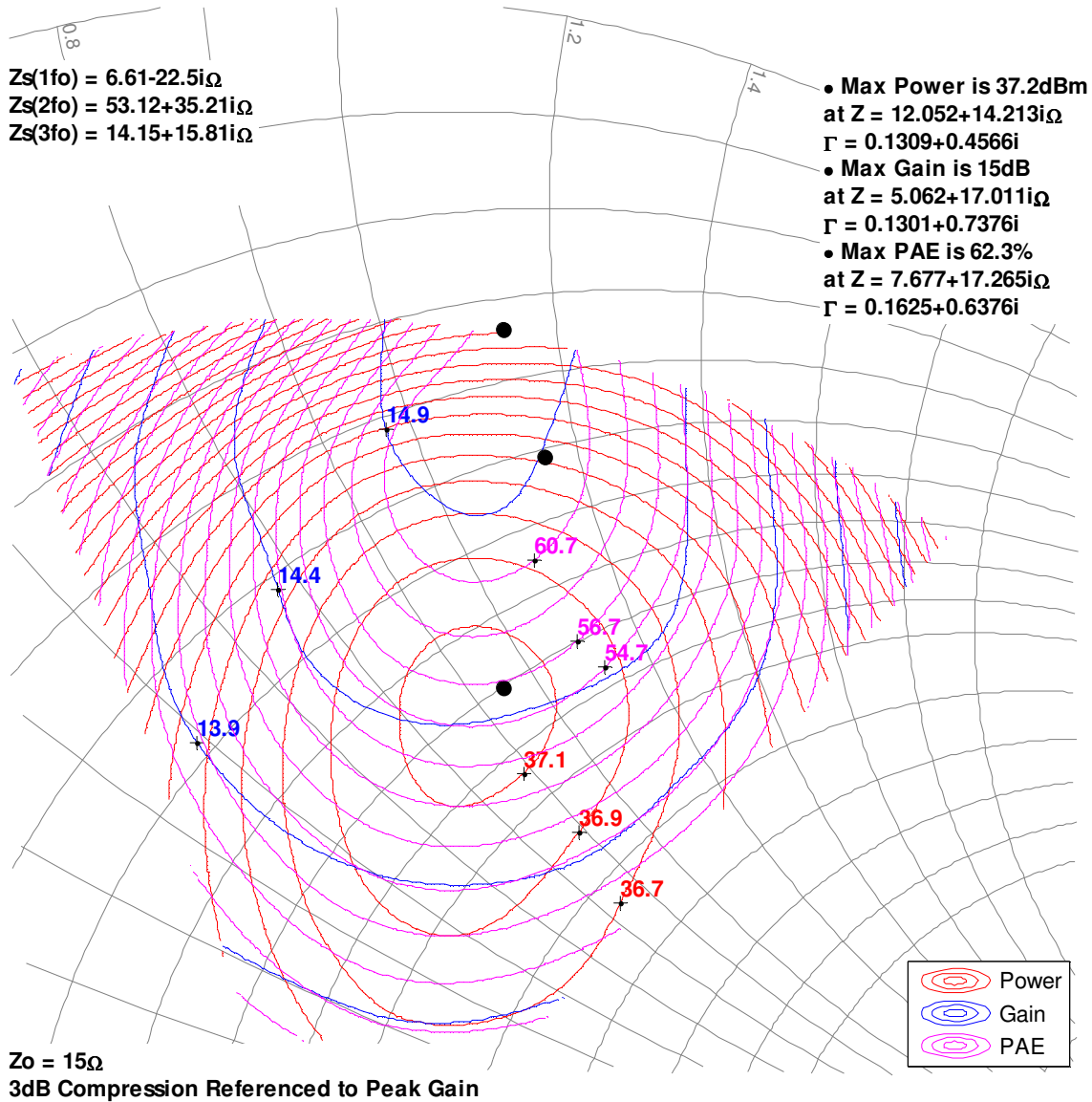

Measured Load-Pull Smith Charts^{1,2}

Notes:

1. Test Conditions: $V_D = 32\text{ V}$, $I_{DQ} = 25\text{ mA}$, 100 uS Pulse Width, 20% Duty Cycle
2. See page 21 for load pull reference planes where the performance was measured.

8GHz, Load-pull

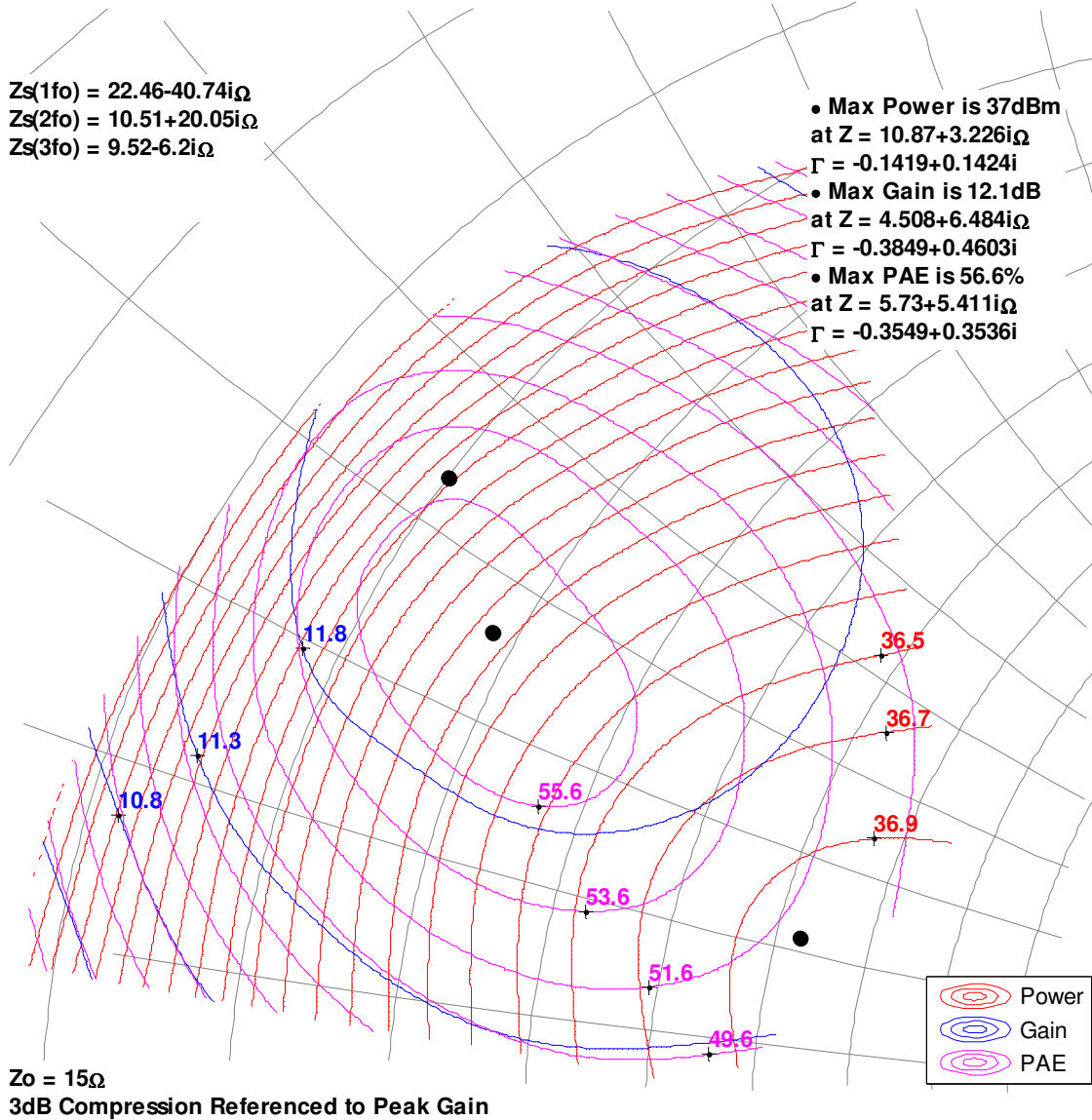

Measured Load-Pull Smith Charts^{1,2}

Notes:

1. Test Conditions: $V_D = 32\text{ V}$, $I_{DQ} = 25\text{ mA}$, 100 uS Pulse Width, 20% Duty Cycle
2. See page 21 for load pull reference planes where the performance was measured.

9GHz, Load-pull

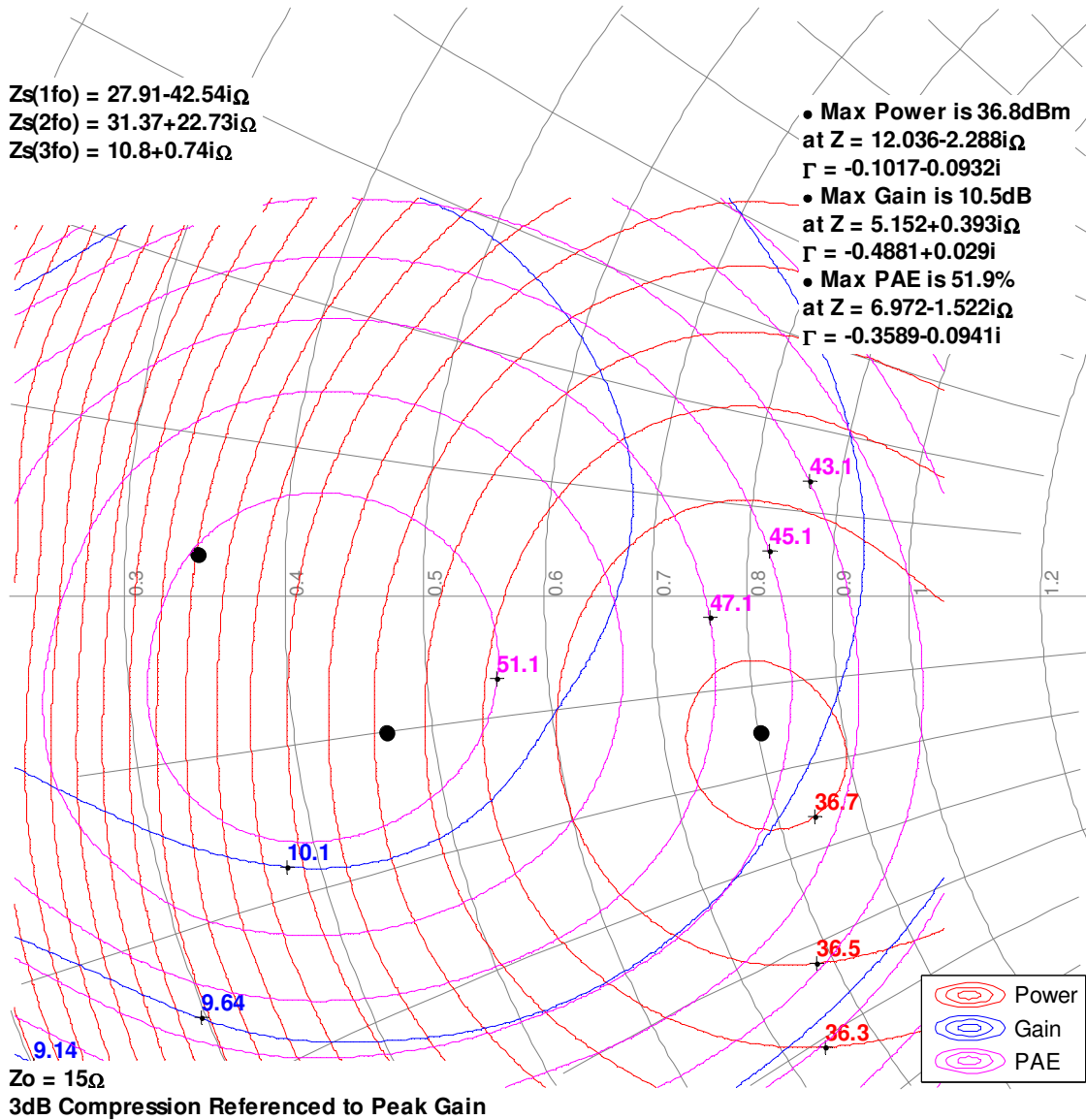

Measured Load-Pull Smith Charts^{1,2}

Notes:

1. Test Conditions: $V_D = 32\text{ V}$, $I_{DQ} = 25\text{ mA}$, 100 μS Pulse Width, 20% Duty Cycle
2. See page 21 for load pull reference planes where the performance was measured.

10GHz, Load-pull

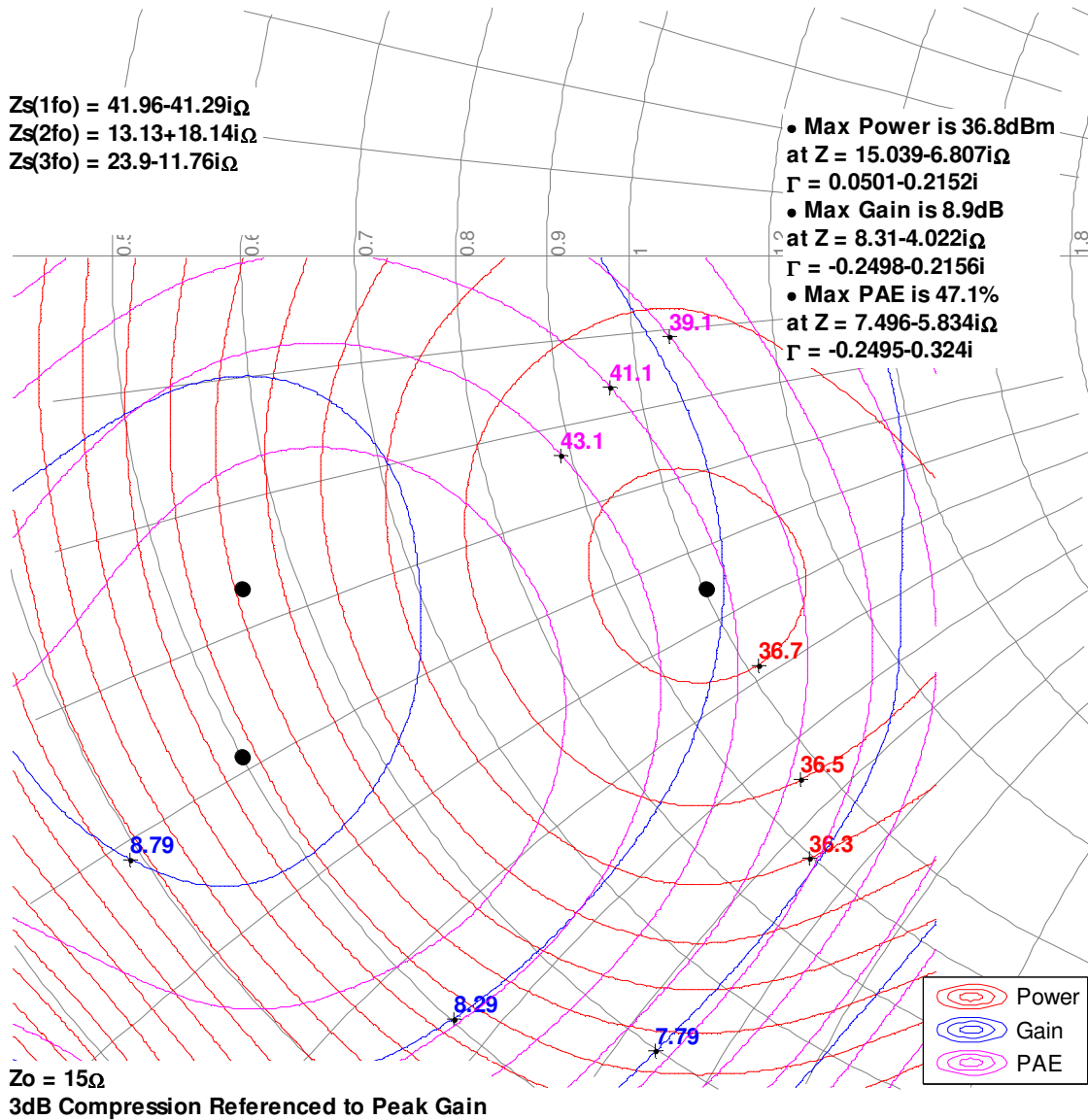

Measured Load-Pull Smith Charts^{1,2}

Notes:

1. Test Conditions: $V_D = 32\text{ V}$, $I_{DQ} = 25\text{ mA}$, 100 uS Pulse Width, 20% Duty Cycle
2. See page 21 for load pull reference planes where the performance was measured.

12GHz, Load-pull

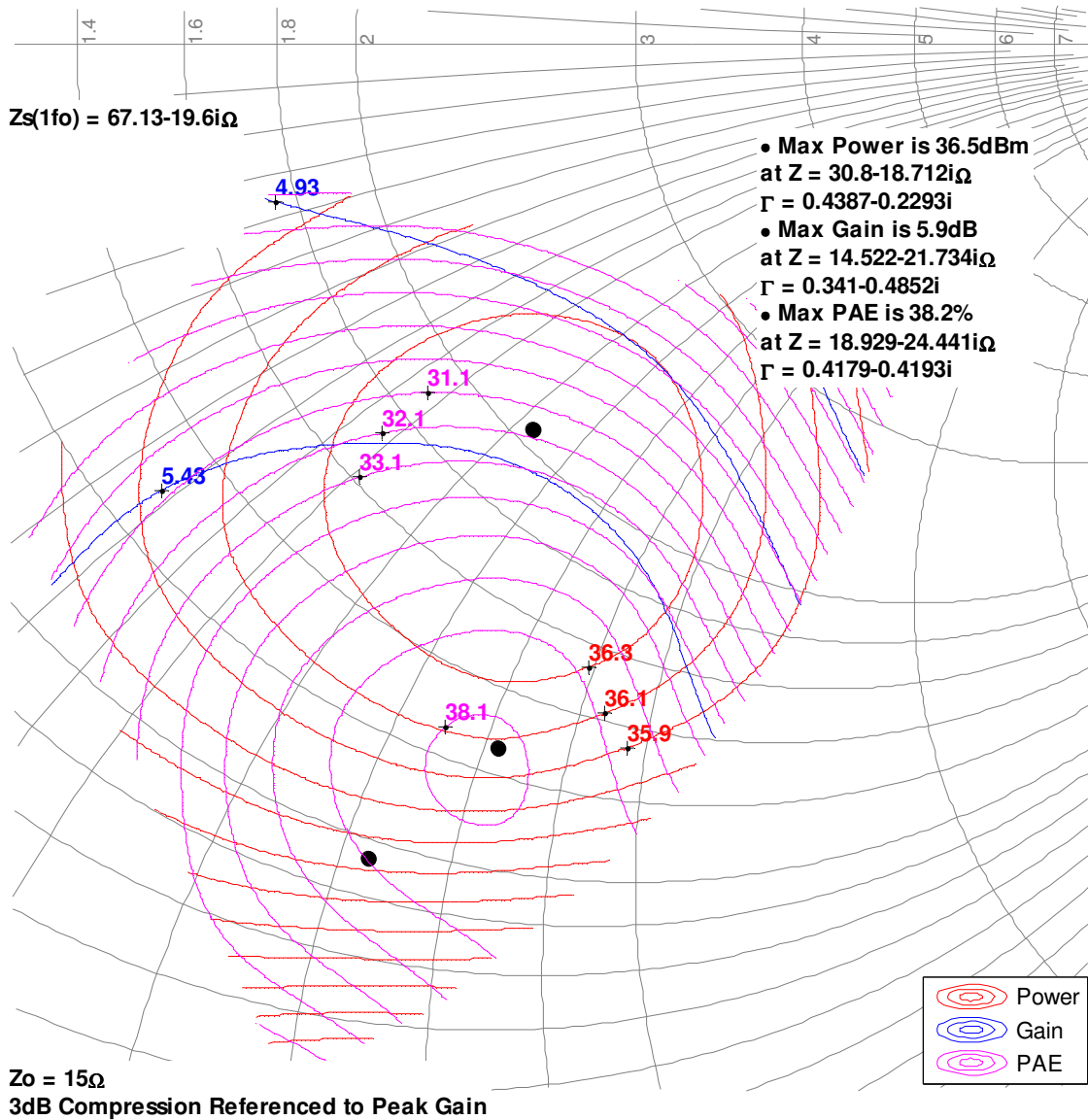

Typical Measured Performance – Load-Pull Drive-up^{1, 2}

Notes:

1. Test Conditions: $V_D = 32\text{ V}$, $I_{DQ} = 25\text{ mA}$, 100 μs Pulse Width, 20% Duty Cycle
2. See page 21 for load-pull and source-pull reference planes PAE where the performance was measured.

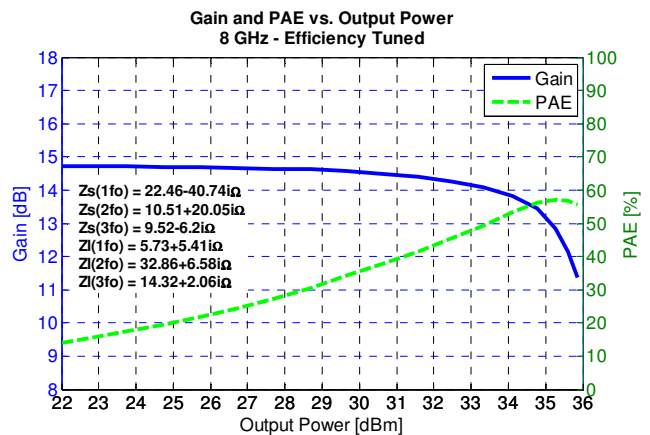
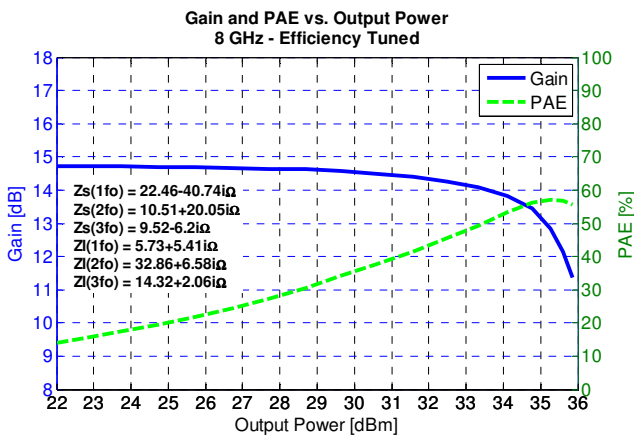
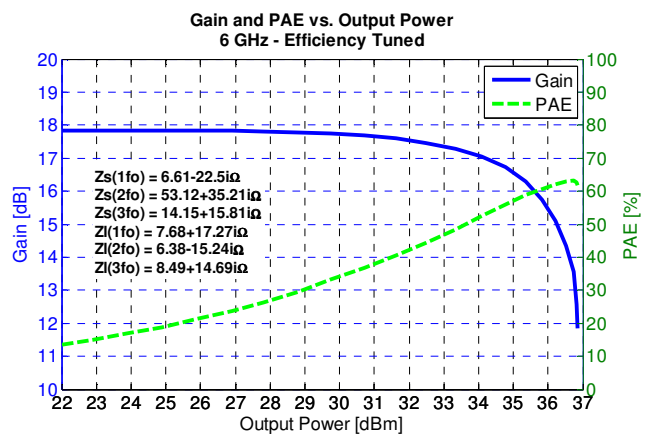
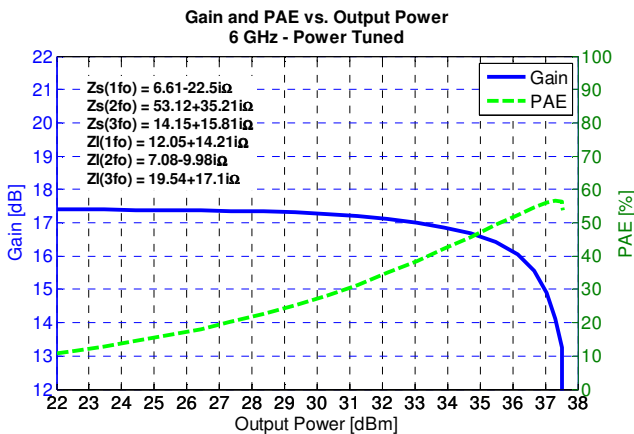
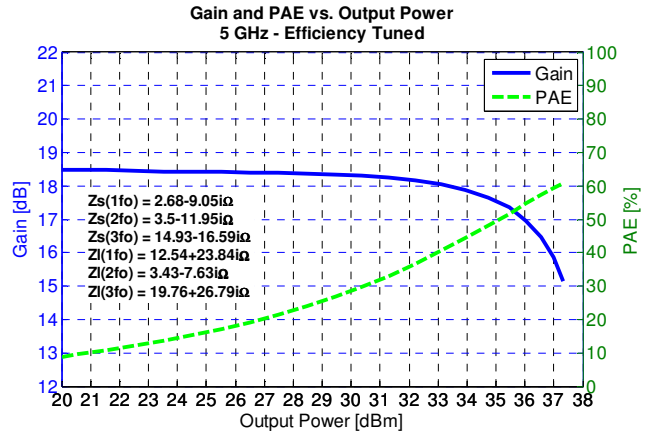
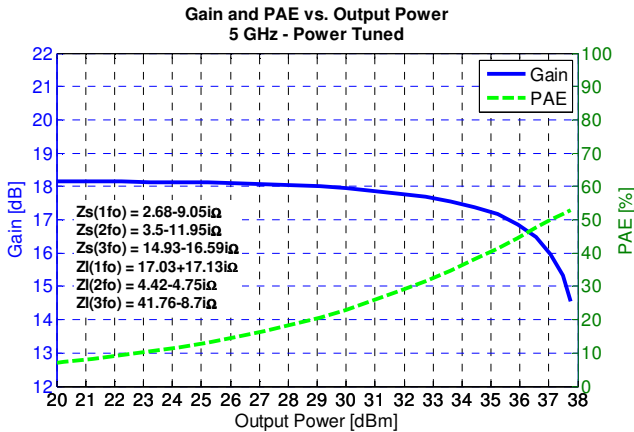

Typical Measured Performance – Load-Pull Drive-up^{1, 2}

Notes:

1. C Test Conditions: $V_D = 32\text{ V}$, $I_{DQ} = 25\text{ mA}$, 100 μs Pulse Width, 20% Duty Cycle
2. See page 21 for load-pull and source-pull reference planes where the performance was measured.

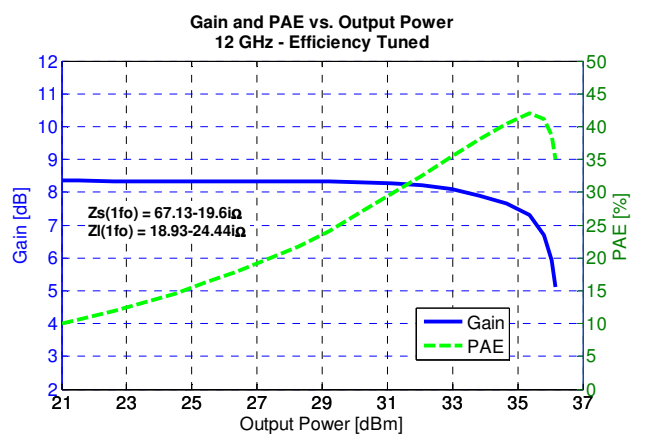
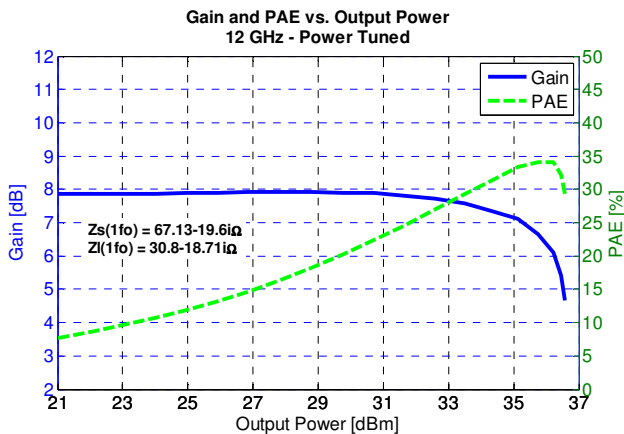
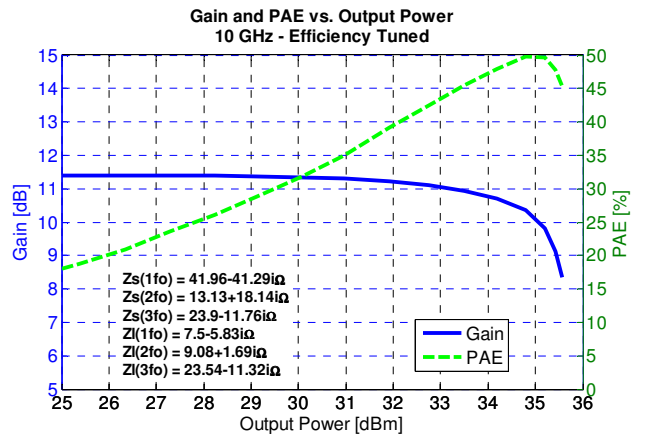
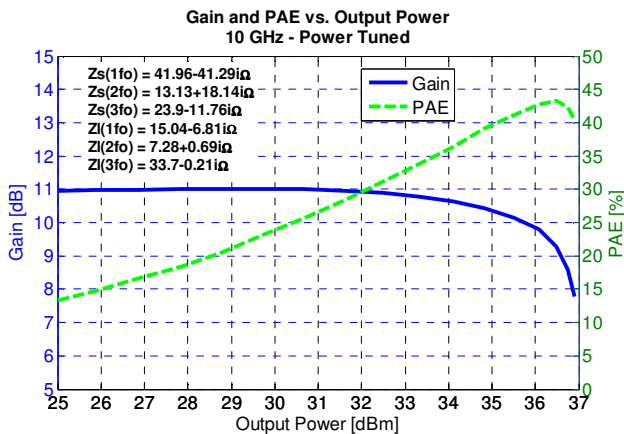
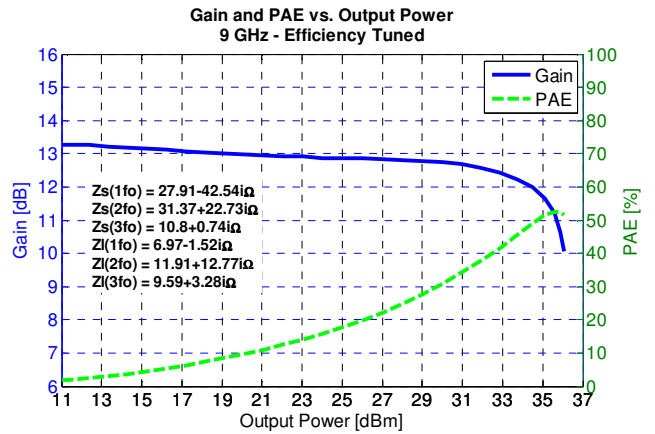
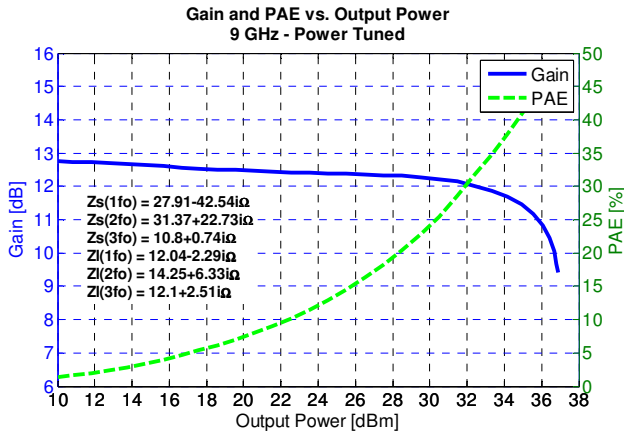

S-Parameters Of 9 – 10 GHz EVB at -40°C¹

Notes:

1. Test Conditions: $V_D = 32\text{ V}$, $I_{DQ} = 35\text{ mA}$

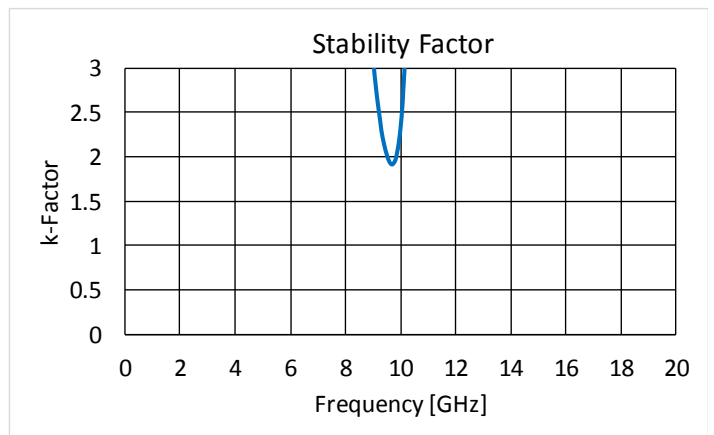
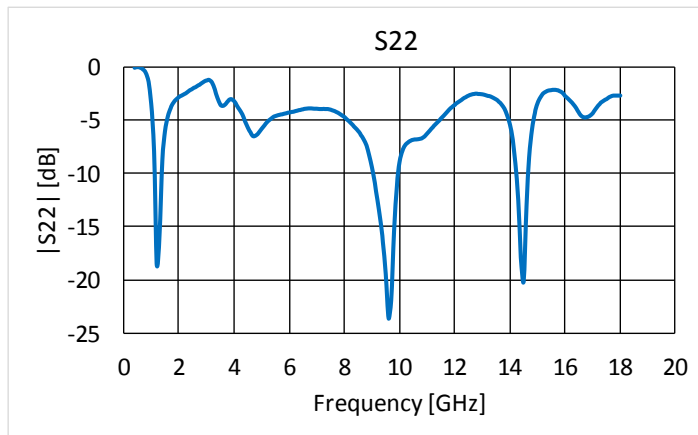
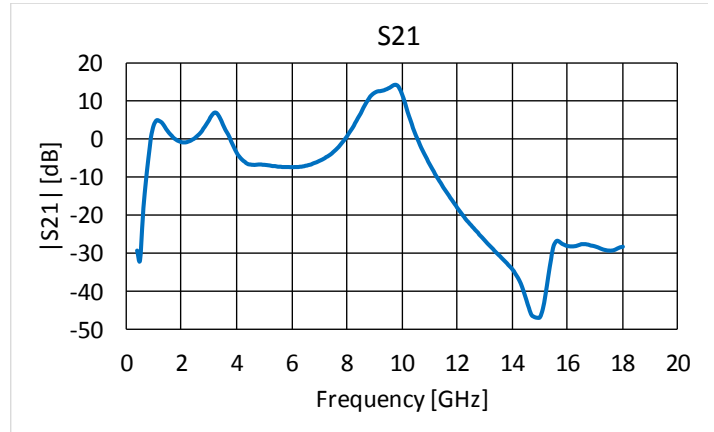
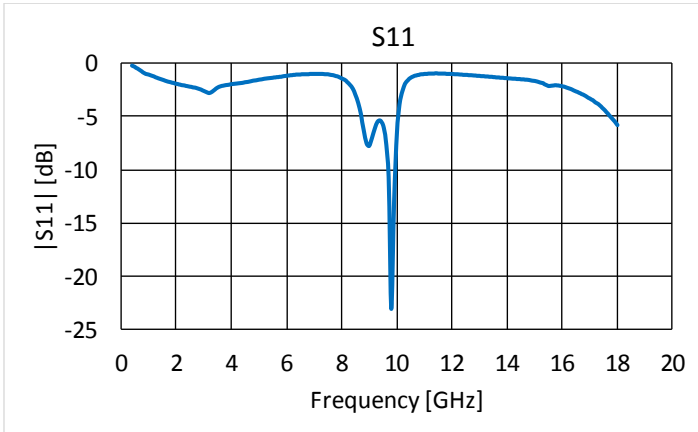

Power Driveup Performance Over Temperatures Of 9 – 10 GHz EVB^{1,2}

Notes:

2. Test Conditions: $V_D = 32\text{ V}$, $I_{DQ} = 35\text{ mA}$, 100 μs Pulse Width, 20% Duty Cycle
3. The dissipation power limit is conservative because it is specified at DUT only without accounting for the loss of the output matching network.

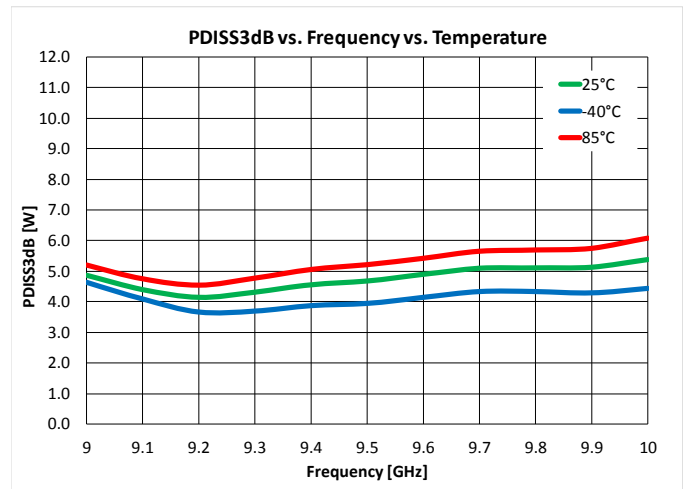
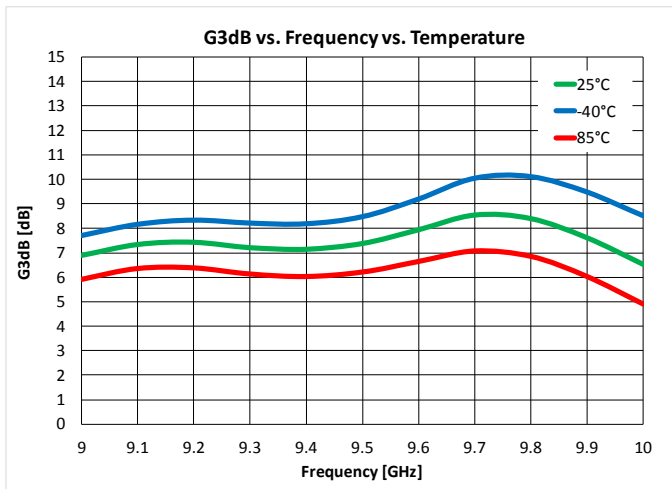
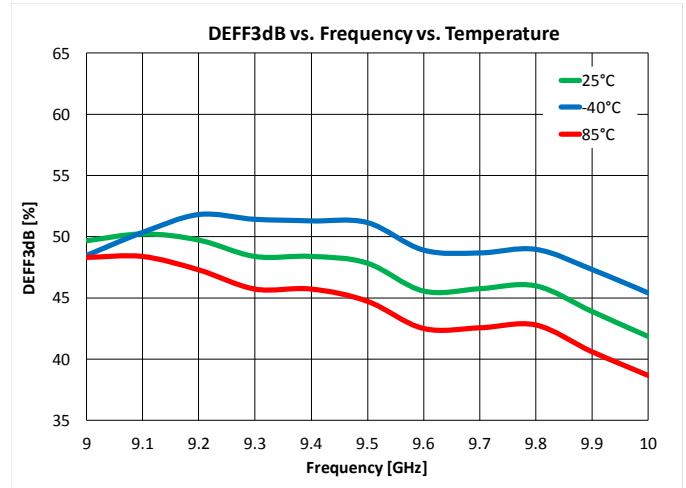
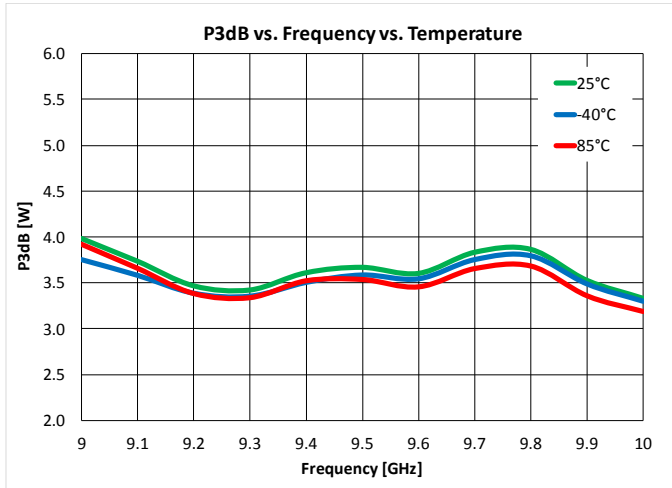

Power Driveup Performance At 25°C Of 9 – 10 GHz EVB^{1,2}

Notes:

1. Test Conditions: $V_D = 32\text{ V}$, $I_{DQ} = 35\text{ mA}$, 100 μs Pulse Width, 20% Duty Cycle
2. The dissipation power is conservative because it is specified at DUT only without accounting for the loss of the output matching network..

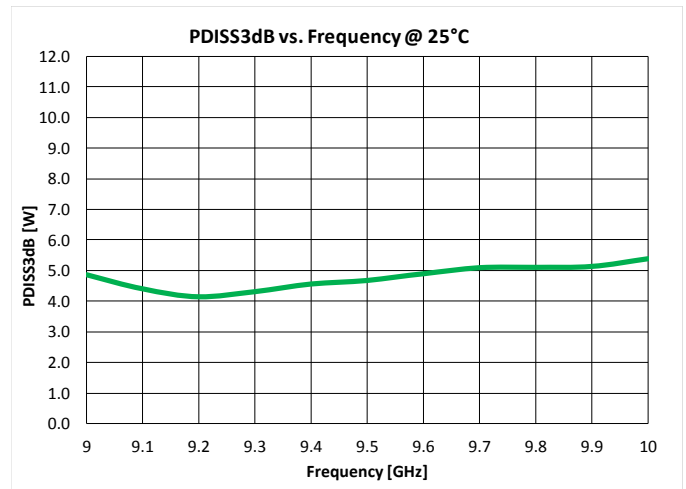
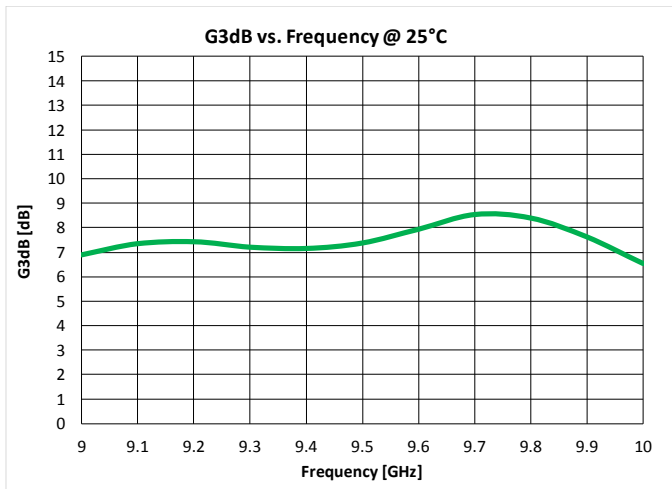
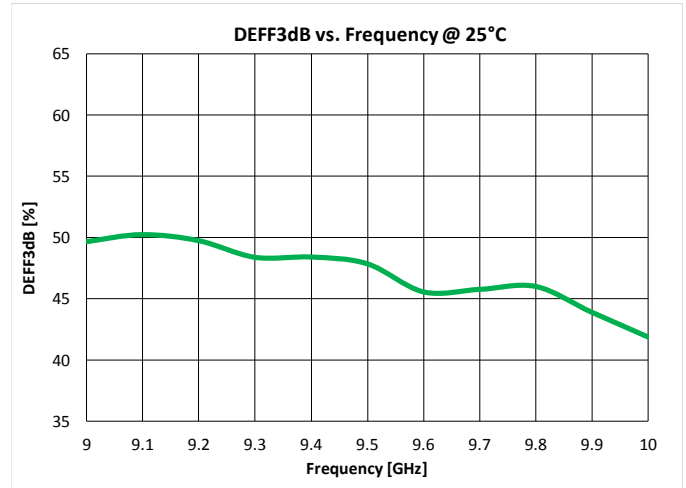
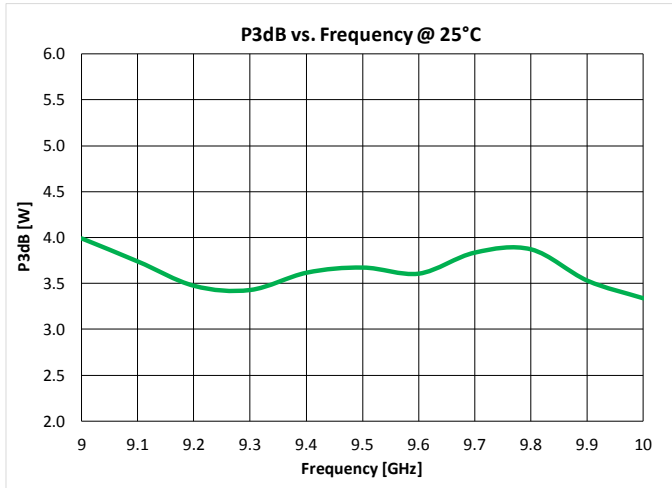

S-Parameters Of 2.6 – 4.2GHz EVB¹

Notes:

1. Test Conditions: $V_D = 32\text{ V}$, $I_{DQ} = 25\text{ mA}$, $T = 25^\circ\text{C}$

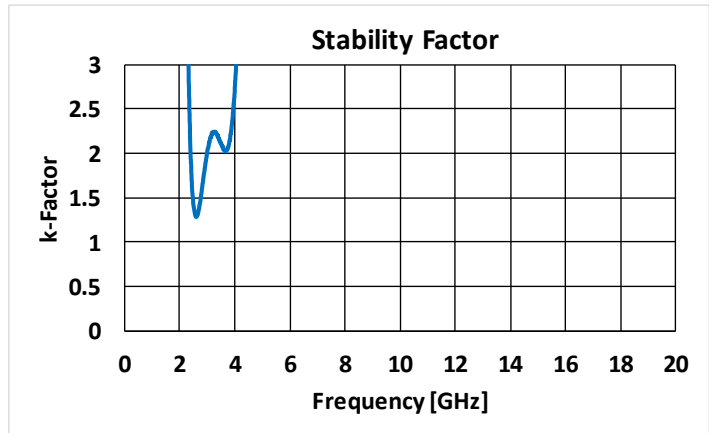
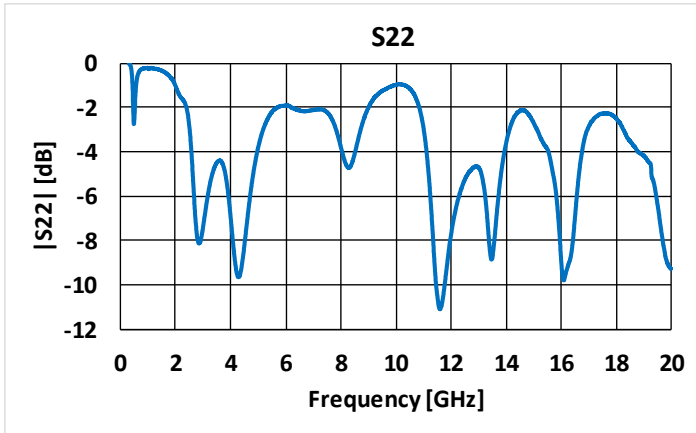
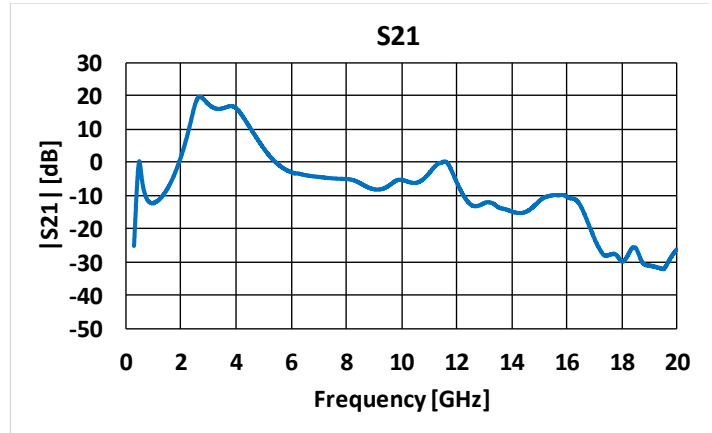
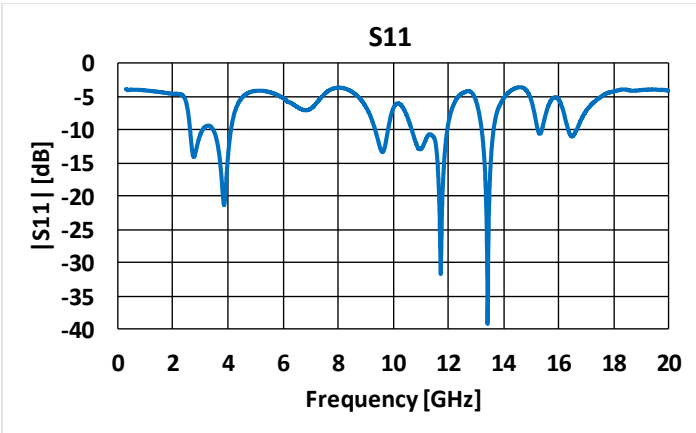

Power Driveup Performance Of 2.6 – 4.2GHz EVB^{1,2}

Notes:

3. Test Conditions: $V_D = 32\text{ V}$, $I_{DQ} = 25\text{ mA}$, 100 μs Pulse Width, 20% Duty Cycle, $T = 25^\circ\text{C}$
4. The dissipation power is conservative because it is specified at DUT only without accounting for the loss of the output matching network..

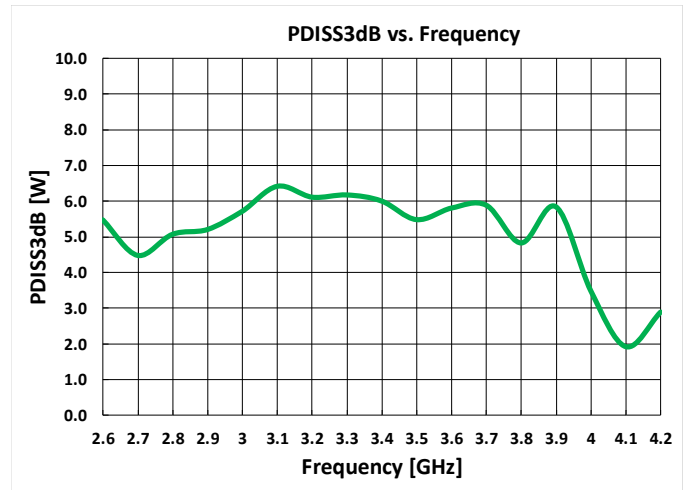
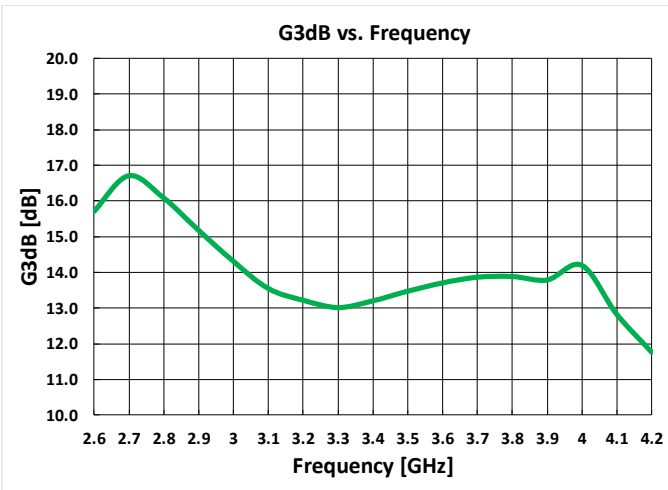
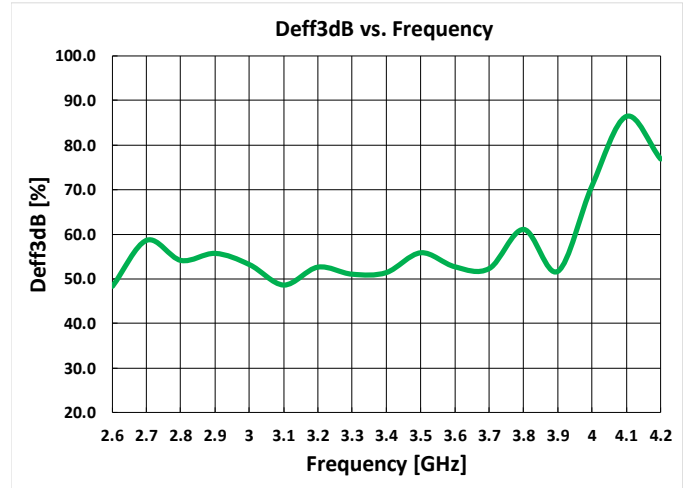
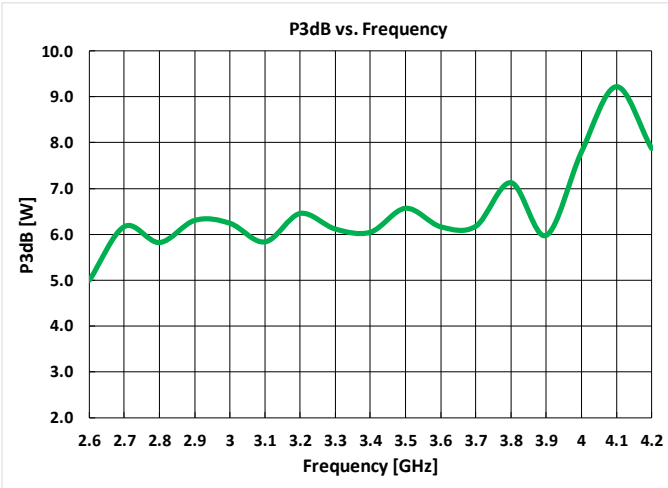

Thermal and Reliability Information – Pulsed^{1, 2, 3, 4}

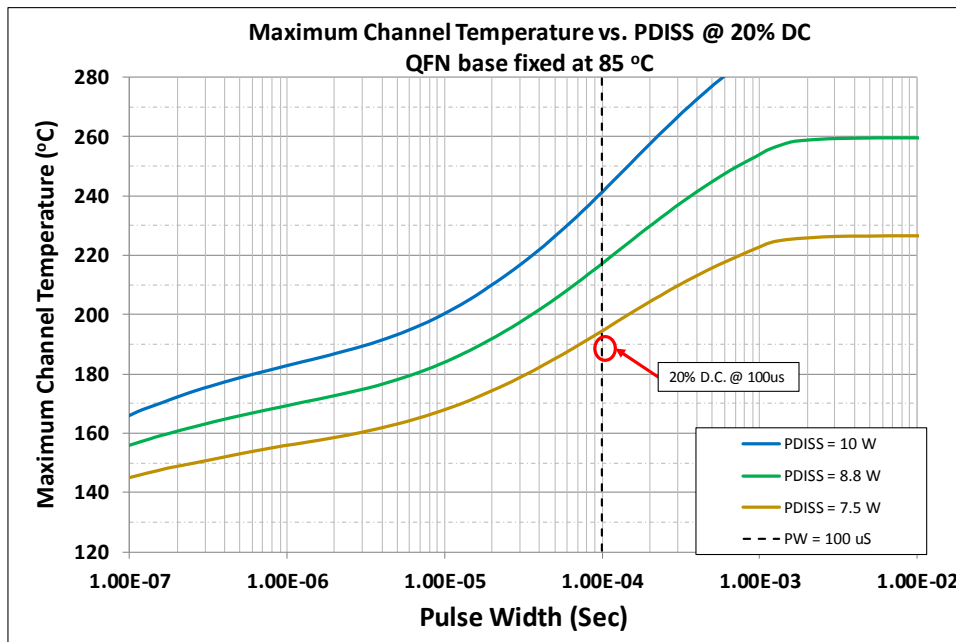

Parameter	Conditions	Values	Units
Thermal Resistance (θ_{JC})	85 °C Case 10.1 W Pdiss, 100uS PW, 20%	15.4	°C/W
Peak Channel Temperature (T_{CH})		241	°C
Median Lifetime (T_M) ¹		2.6E6	Hrs
Thermal Resistance, IR (θ_{JC})		9.8	°C/W
Max. Channel Temperature, IR (T_{CH})		184	°C
Thermal Resistance (θ_{JC})	85 °C Case 9.2 W Pdiss, 100uS PW, 20%	15.2	°C/W
Peak Channel Temperature (T_{CH})		225	°C
Median Lifetime (T_M) ¹		9.0E06	Hrs
Thermal Resistance, IR (θ_{JC})		9.8	°C/W
Max. Channel Temperature, IR (T_{CH})		175	°C
Thermal Resistance (θ_{JC})	85 °C Case 8.8 W Pdiss, 100uS PW, 20%	15.0	°C/W
Peak Channel Temperature (T_{CH})		217	°C
Median Lifetime (T_M) ¹		1.8E07	Hrs
Thermal Resistance, IR (θ_{JC})		9.8	°C/W
Max. Channel Temperature, IR (T_{CH})		171	°C
Thermal Resistance (θ_{JC})	85 °C Case 7.6 W Pdiss, 100uS PW, 20%	14.5	°C/W
Peak Channel Temperature (T_{CH})		195	°C
Median Lifetime (T_M) ¹		1.2E08	Hrs
Thermal Resistance, IR (θ_{JC})		9.6	°C/W
Max. Channel Temperature, IR (T_{CH})		158	°C

Notes:

1. Finite Element Analysis (FEA) thermal values shall be used to determine performance and reliability. Unless otherwise noted, all thermal references are FEA.
2. Infrared (IR) thermal values are for reference only.
3. Thermal resistance measured to backside of package.
4. Median lifetime under pulsed condition is the lifetime under CW condition divided by the duty cycle.

Thermal and Reliability Information – CW^{1, 2, 3}

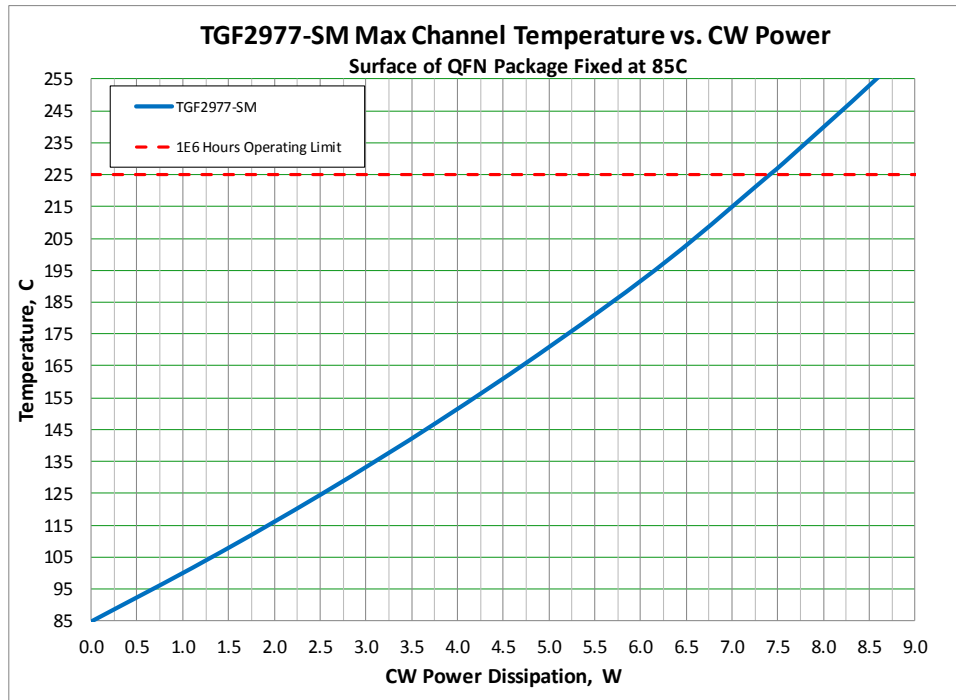

Parameter	Conditions	Values	Units
Thermal Resistance (θ_{JC})		20.1	$^{\circ}\text{C}/\text{W}$
Maximum Channel Temperature (T_{CH})		262	$^{\circ}\text{C}$
Median Lifetime (T_M)		1.1E05	Hrs
Thermal Resistance, IR (θ_{JC})		12.6	$^{\circ}\text{C}/\text{W}$
Max. Channel Temperature, IR (T_{CH})		196	$^{\circ}\text{C}$
Thermal Resistance (θ_{JC})		18.9	$^{\circ}\text{C}/\text{W}$
Maximum Channel Temperature (T_{CH})		225	$^{\circ}\text{C}$
Median Lifetime (T_M)		1.8E6	Hrs
Thermal Resistance, IR (θ_{JC})		12.2	$^{\circ}\text{C}/\text{W}$
Max. Channel Temperature, IR (T_{CH})		175	$^{\circ}\text{C}$
Thermal Resistance (θ_{JC})		17.9	$^{\circ}\text{C}/\text{W}$
Maximum Channel Temperature (T_{CH})		198	$^{\circ}\text{C}$
Median Lifetime (T_M)		1.9E07	Hrs
Thermal Resistance, IR (θ_{JC})		11.7	$^{\circ}\text{C}/\text{W}$
Max. Channel Temperature, IR (T_{CH})		159	$^{\circ}\text{C}$
Thermal Resistance (θ_{JC})		17.4	$^{\circ}\text{C}/\text{W}$
Maximum Channel Temperature (T_{CH})		172	$^{\circ}\text{C}$
Median Lifetime (T_M)		2.3E08	Hrs
Thermal Resistance, IR (θ_{JC})		11.8	$^{\circ}\text{C}/\text{W}$
Max. Channel Temperature, IR (T_{CH})		144	$^{\circ}\text{C}$

Notes:

1. Finite Element Analysis (FEA) thermal values shall be used to determine performance and reliability. Unless otherwise noted, all thermal references are FEA.
2. Infrared (IR) thermal values are for reference only.
3. Thermal resistance measured to backside of package.

Median Lifetime¹

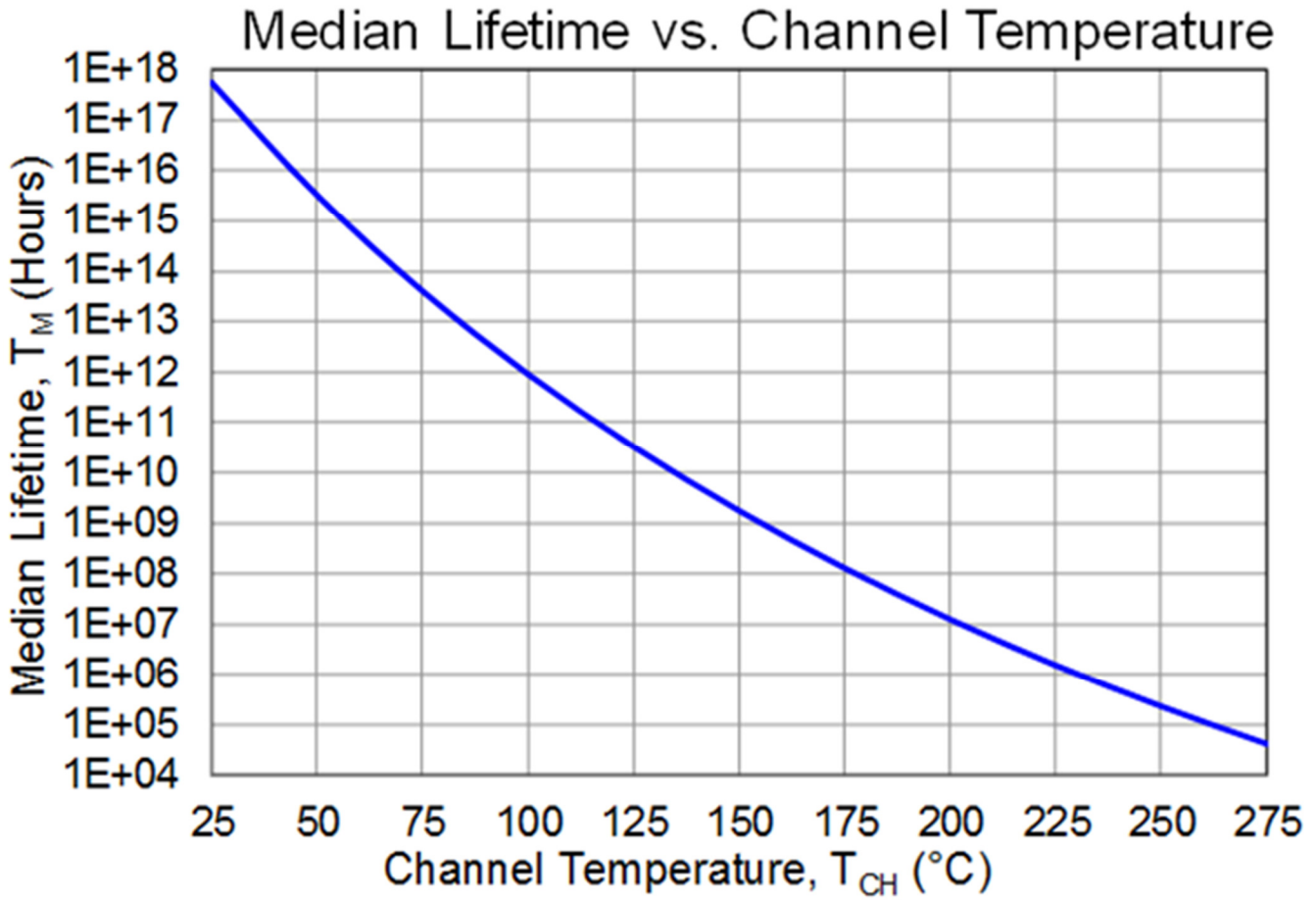

Notes:

1. Test Conditions: $V_D = +32 V$; Failure Criteria = 10% reduction in I_{D_MAX} during DC Life Testing .

Maximum Gate Current

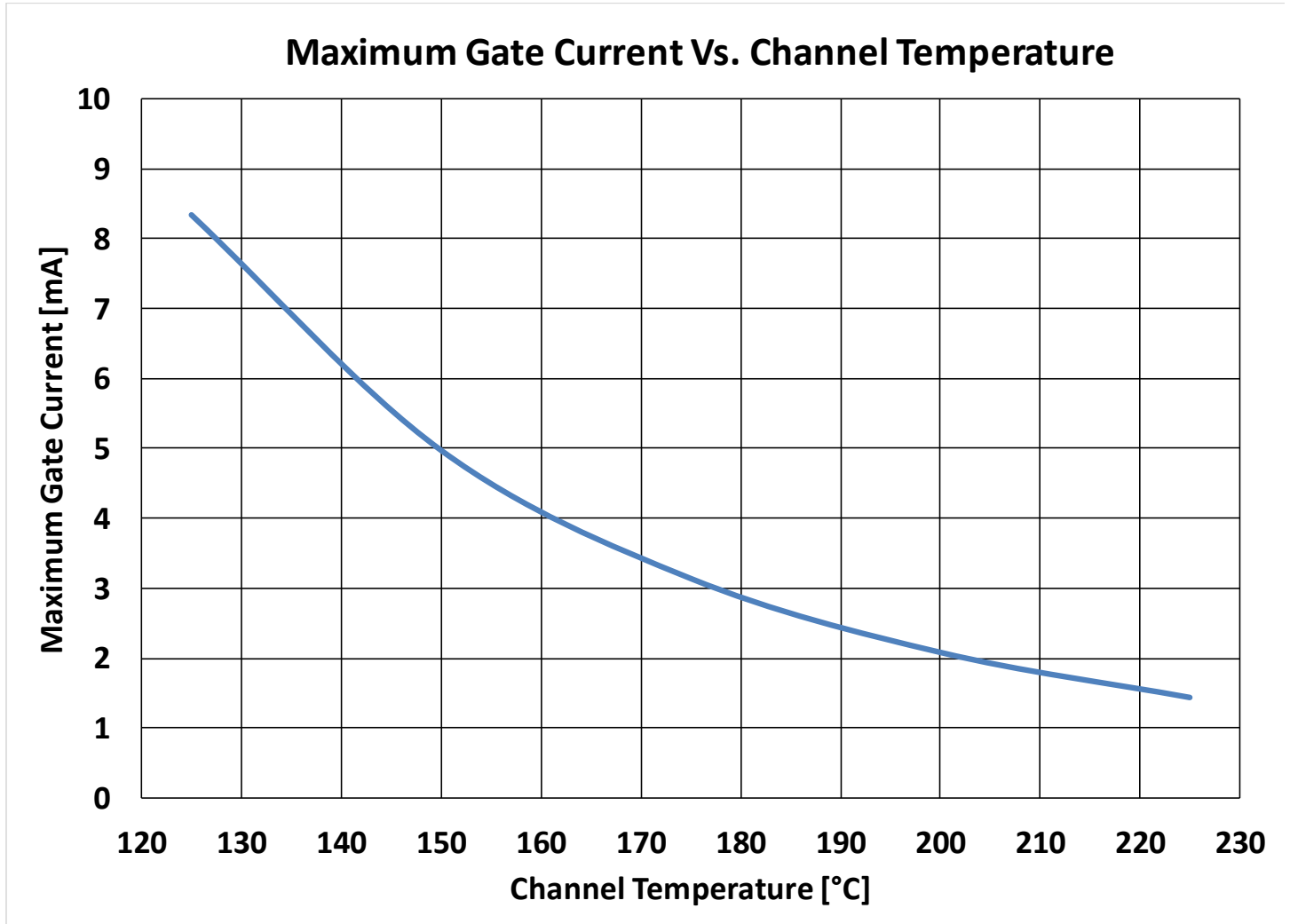

Pin Configuration and Description¹

Note 1: The TGF2977-SM will be marked with the “2977” designator and a lot code marked below the part designator. The “YY” represents the last two digits of the calendar year the part was manufactured, the “WW” is the work week of the assembly lot start, the MZZZ” is the production lot number.

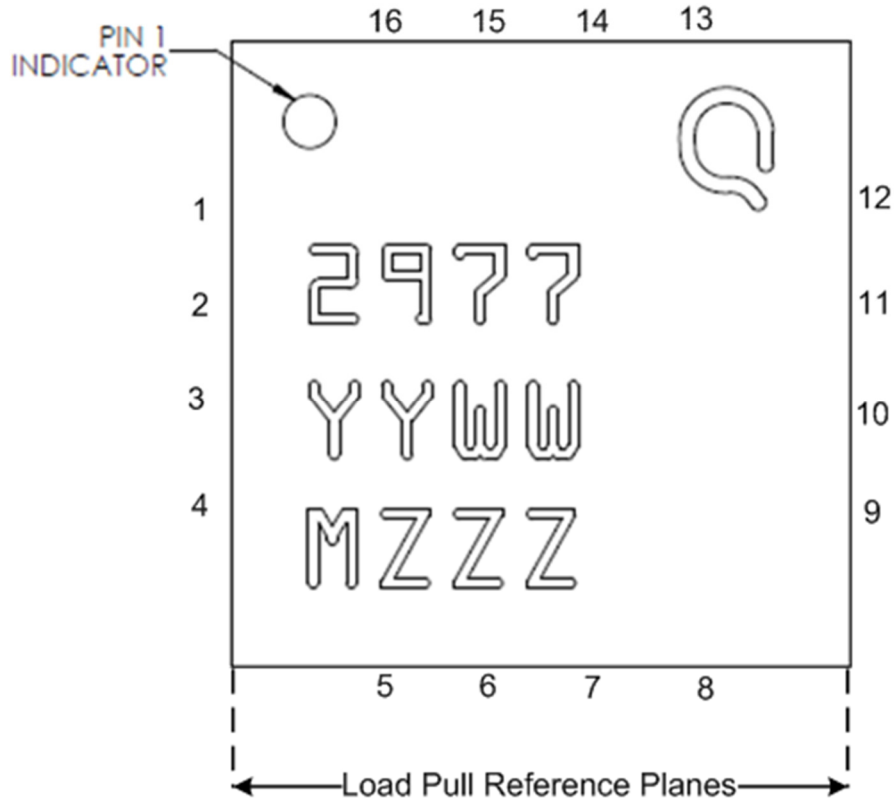

Pin	Symbol	Description
2	RF IN / V _G	Gate
10 - 11	RF OUT / V _D	Drain
1, 3 – 9, 12 - 16	NC	Not Connected
Back side	Source	Source / Ground / Backside of part

Mechanical Drawing^{1, 2, 3}

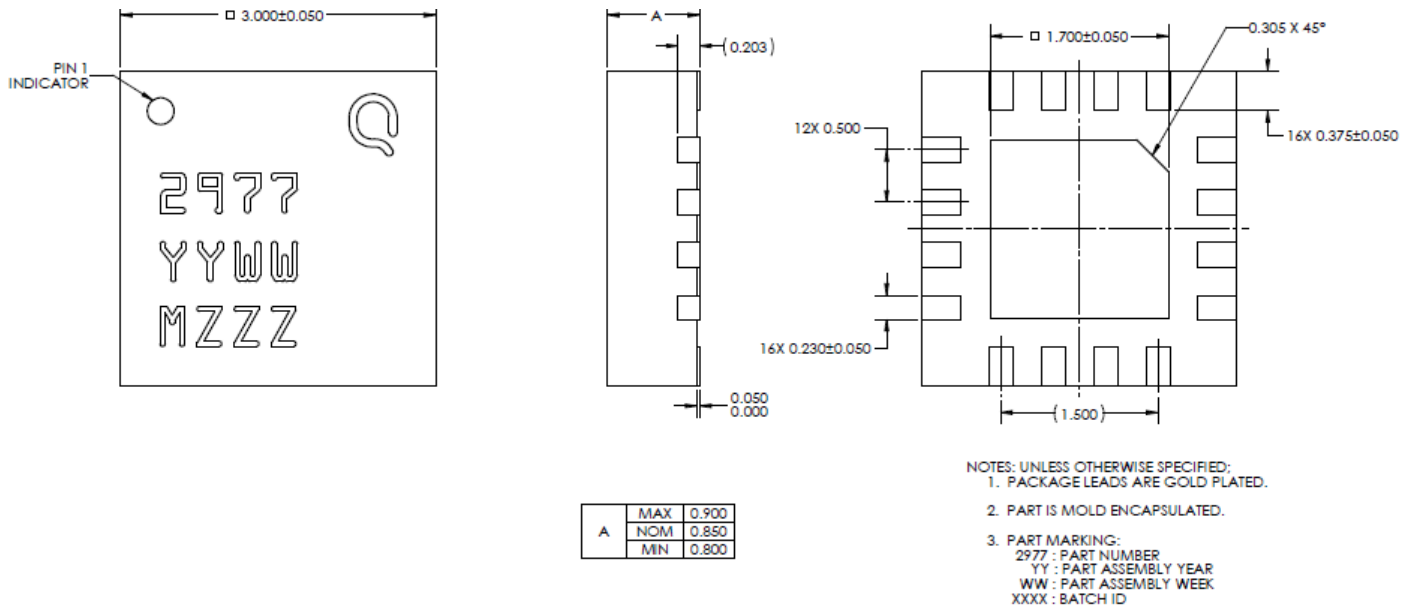

Note:

1. All dimensions are in millimeters.
2. Unless otherwise noted, all dimension tolerances are ± 0.127 mm.
3. This package is lead-free/RoHS-compliant. The plating material on the leads is NiAu. It is compatible with both lead-free (maximum 260°C reflow temperature) and tin-lead (maximum 245°C reflow temperature) soldering process.

9 – 10 GHz Application Circuit - Schematic

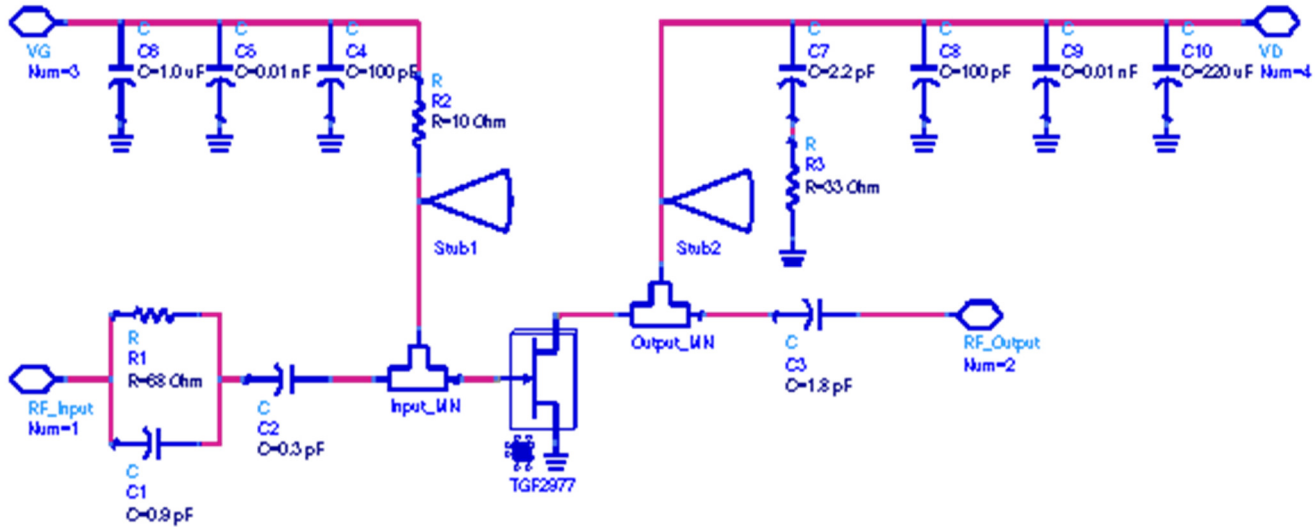

Bias-up Procedure

1. Set V_G to -4 V.
2. Set I_D current limit to 30 mA.
3. Apply 32 V V_D .
4. Slowly adjust V_G until I_D is set to 25 mA.
5. Set I_D current limit to 0.4 A (Pulsed operation)
6. Apply RF.

Bias-down Procedure

1. Turn off RF signal.
2. Turn off V_D
3. Wait 2 seconds to allow drain capacitor to discharge
4. Turn off V_G

9 – 10 GHz Application Circuit - Bill Of material

Description	Ref. Des.	Manufacturer	Part Number
Capacitor 0.9pF, 200V, 0402	C1	American Technical Ceramics	600L0R3AT200T
Capacitor 0.3 pF, 200V, 0402	C2	American Technical Ceramics	600L0R3AT200T
Capacitor 1.8 pF, 200V, 0402	C3	American Technical Ceramics	600L1R8AT200T
Capacitor 2.2 pF, 200V, 0402	C7	American Technical Ceramics	600L2R2BT200T
Capacitor 100 pF, 200V, 0603	C4, C8	Carpax Technologies	0603G101J201S
Capacitor 0.1 nF, 200V, 0603	C5, C9	Digi-Key	C0805C103K5RACTU
Capacitor 1 uF, 200V, 1206	C6	Digi-Key	C1206C105K4RACTU
Capacitor, Electrolytic, 47 uF, 50V, 10mm SMD	C16	Panasonic	EEETG1H470P
Resistor, 68 Ohm, 0402	R1	Panasonic	ERJ-2RKF68R0X
Resistor, 10 Ohm, 0603	R2		Generic 0603
Resistor, 33 Ohm, 0603	R3		Generic 0603

9 – 10 GHz Application Circuit - Layout

Board material is RO4003C 0.008" thickness with 1oz copper cladding. Overall EVB size is 1.5" x 2".

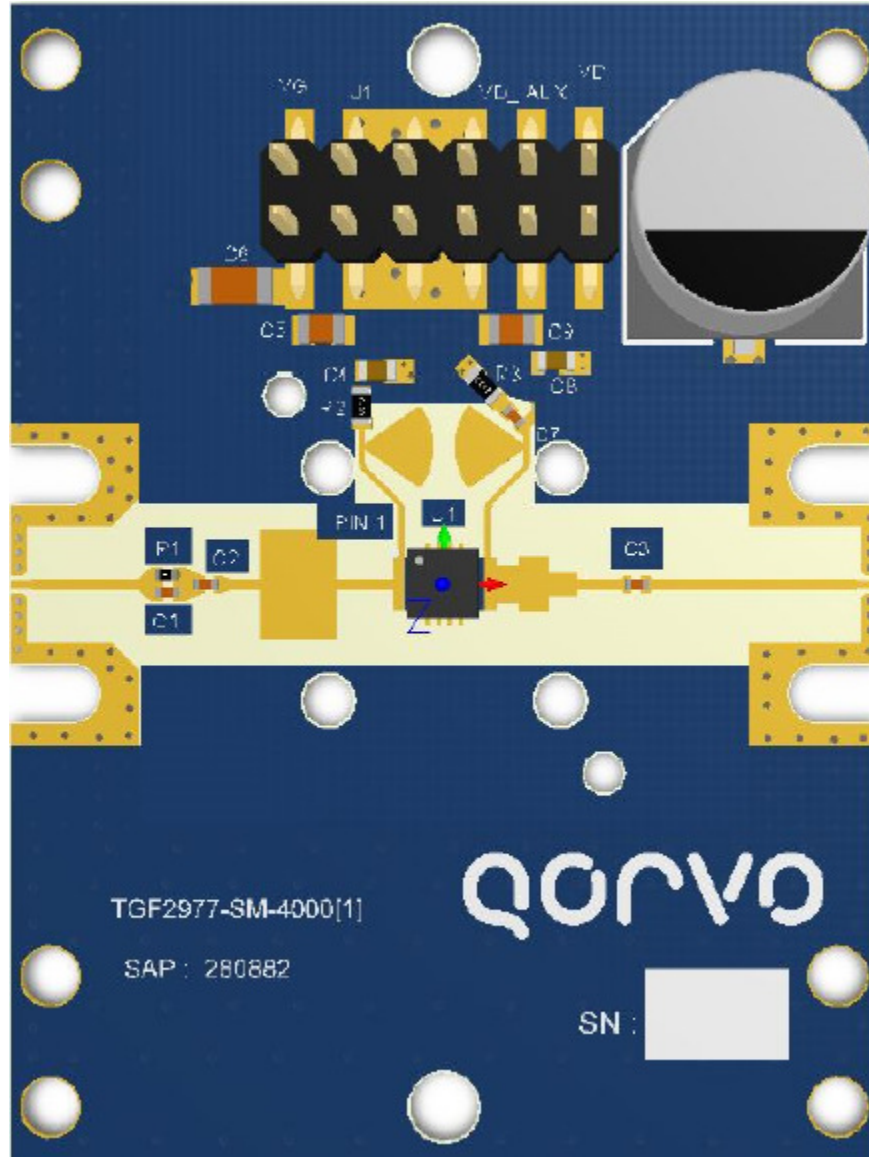

2.6 – 4.2 GHz Application Circuit - Schematic

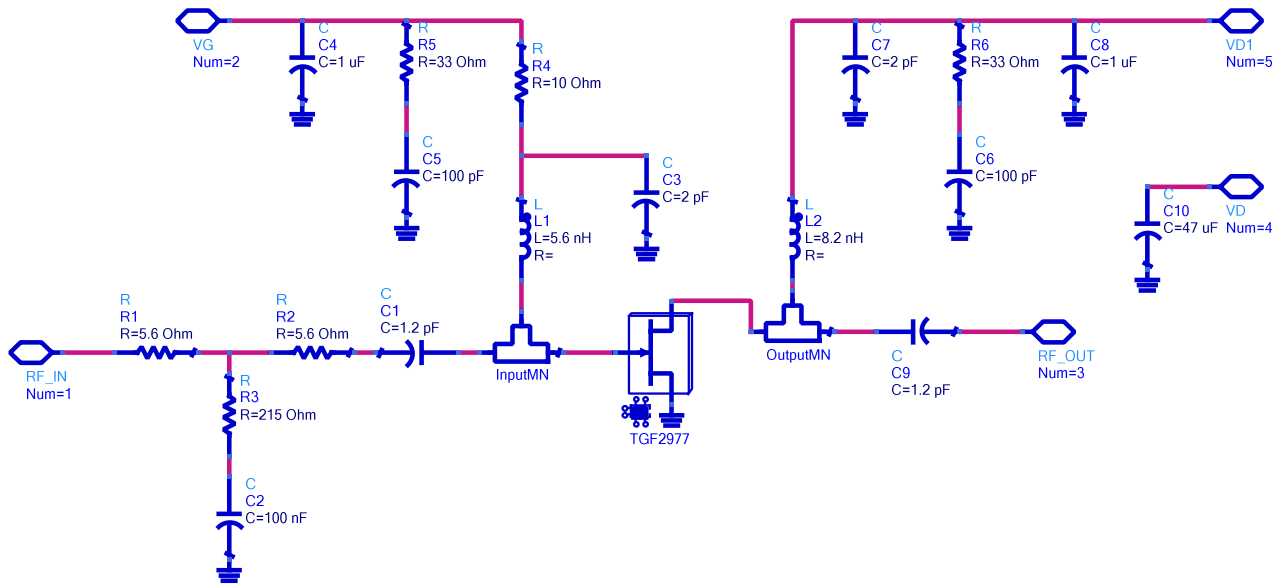

Bias-up Procedure

1. Set V_G to -4 V.
2. Set I_D current limit to 30 mA.
3. Apply 32 V V_D .
4. Slowly adjust V_G until I_D is set to 25 mA.
5. Set I_D current limit to 0.5 A (Pulsed operation)
6. Apply RF.

Bias-down Procedure

1. Turn off RF signal.
2. Turn off V_D
3. Wait 2 seconds to allow drain capacitor to discharge
4. Turn off V_G

2.6 – 4.2 GHz Application Circuit - Bill Of material

Description	Ref. Des.	Manufacturer	Part Number
Capacitor 1.2pF, 250V, 0603	C1, C9	ATC	600S1R2AT250XT
Capacitor 0.1 uF, 100V, 0603	C2	AVX	0603YC104KAT2A
Capacitor 2.2 pF, 250V, 0603	C3, C7	ATC	600S2R2BT250T
Capacitor 100 pF, 200V, 0603	C5, C6	Capax Technologies	0603G101J201S
Capacitor 1 uF, 200V, 0805	C4, C8	TTI Inc.	C2012X7S2A105M125AB
Capacitor, Electrolytic, 47 uF, 50V	C10	Panasonic	EEETG1H470P
Inductor 5.6 nH, 0603	L1	Coilcraft	0603CS-5N6XJEW
Inductor 8.2 nH, 0603	L2	Coilcraft	0603HP-8N2XJLW
Resistor, 5.6 Ohm, 0603	R1, R2	TTI	CRCW06035R60JNEA
Resistor, 215 Ohm, 0603	R3	Digi-Key	CRCW0603215RFKEA
Resistor, 33.2 Ohm, 0603	R5, R6	TTI	CRCW060333R2FKTA
Resistor, 10 Ohm, 0603	R4	TTI	CRCW060310R0JNTA

2.6 – 4.2 GHz Application Circuit - Layout

Board material is RO4350B 0.020" thickness with 1oz copper cladding. Overall EVB size is 2" x 2.5".

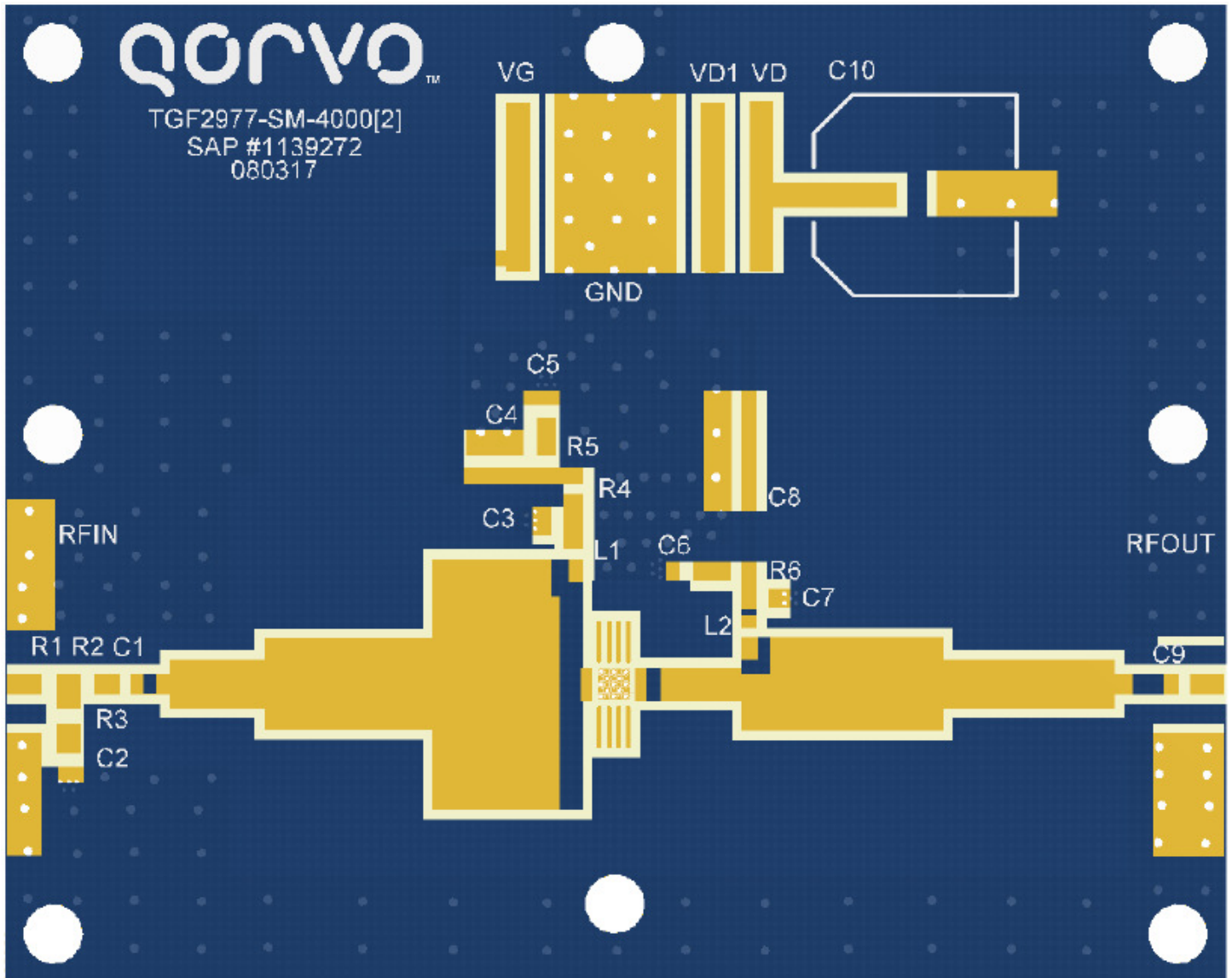

Recommended Solder Temperature Profile

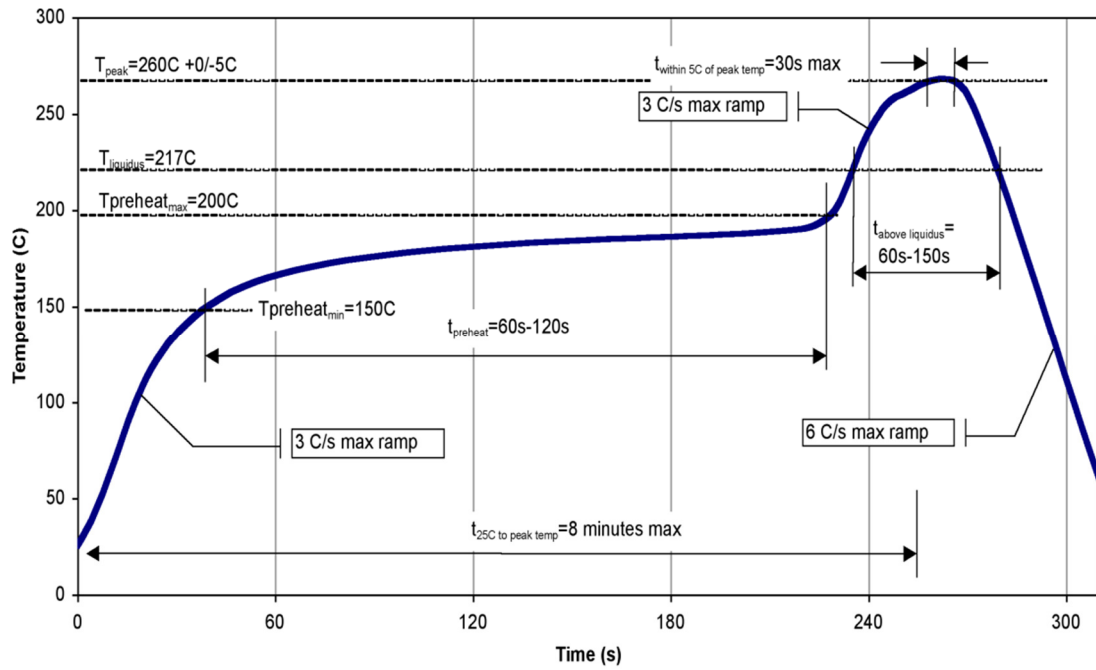

Handling Precautions

Parameter	Rating	Standard
ESD – Human Body Model (HBM)	500 V, 1B	ESDA / JEDEC JS-001-2012
ESD – Charged Device Model (CDM)	1000 V, C3	JEDEC JESD22-C101F
MSL – Moisture Sensitivity Level	TBD	IPC/JEDEC J-STD-020



Caution!
ESD-Sensitive Device

Solderability

Compatible with both lead-free (260°C max. reflow temp.) and tin/lead (245°C max. reflow temp.) soldering processes. Solder profiles available upon request.

Contact plating: NiPdAu

RoHS Compliance

This part is compliant with 2011/65/EU RoHS directive (Restrictions on the Use of Certain Hazardous Substances in Electrical and Electronic Equipment) as amended by Directive 2015/863/EU.

This product also has the following attributes:

- Lead Free
- Halogen Free (Chlorine, Bromine)
- Antimony Free
- TBBP-A (C₁₅H₁₂Br₄O₂) Free
- PFOS Free
- SVHC Free



Contact Information

For the latest specifications, additional product information, worldwide sales and distribution locations, and information about Qorvo:

Web: www.Qorvo.com
Email: info-sales@qorvo.com

Tel: +1.972.994.8465
Fax: +1.972.994.8504

For technical questions and application information: **Email:** info-products@qorvo.com

Important Notice

The information contained herein is believed to be reliable; however, Qorvo makes no warranties regarding the information contained herein and assumes no responsibility or liability whatsoever for the use of the information contained herein. All information contained herein is subject to change without notice. Customers should obtain and verify the latest relevant information before placing orders for Qorvo products. The information contained herein or any use of such information does not grant, explicitly or implicitly, to any party any patent rights, licenses, or any other intellectual property rights, whether with regard to such information itself or anything described by such information. **THIS INFORMATION DOES NOT CONSTITUTE A WARRANTY WITH RESPECT TO THE PRODUCTS DESCRIBED HEREIN, AND QORVO HEREBY DISCLAIMS ANY AND ALL WARRANTIES WITH RESPECT TO SUCH PRODUCTS WHETHER EXPRESS OR IMPLIED BY LAW, COURSE OF DEALING, COURSE OF PERFORMANCE, USAGE OF TRADE OR OTHERWISE, INCLUDING THE IMPLIED WARRANTIES OF MERCHANTABILITY AND FITNESS FOR A PARTICULAR PURPOSE.**

Without limiting the generality of the foregoing, Qorvo products are not warranted or authorized for use as critical components in medical, life-saving, or life-sustaining applications, or other applications where a failure would reasonably be expected to cause severe personal injury or death.

Copyright 2016 © Qorvo, Inc. | Qorvo is a registered trademark of Qorvo, Inc.