

Features

- Ultra low current consumption (6 μ A/comp. at $V_{CC} = 2.7$ V)
- Rail-to-rail CMOS inputs
- Push-pull outputs
- Supply operation from 2.7 to 10 V
- Low propagation delay
- ESD protection (2 kV)
- Latch-up immunity (class A)
- Available in SOT23-5 micropackage, SO-8, SO-14, TSSOP8, and TSSOP14 package

Applications

- Battery powered systems such as alarms
- Portable communication systems
- Smoke/gas/fire detectors
- Portable computers

Description

The TS86x device (single, dual and quad) is a rail-to-rail comparator characterized for 2.7 to 10 V operation over -40 °C to $+85$ °C temperature ranges. It exhibits an excellent speed-to-power ratio, featuring a current consumption of 6 μ A per comparator and a response time of 500 ns at 2.7 V for a 100 mV overdrive.

Due to its ultra low power consumption and its availability in a tiny package, the TS86x comparator family is perfectly suited to battery-powered systems. The output stage is designed with a push-pull structure allowing a direct connection to the microcontroller without additional pull-up resistors.

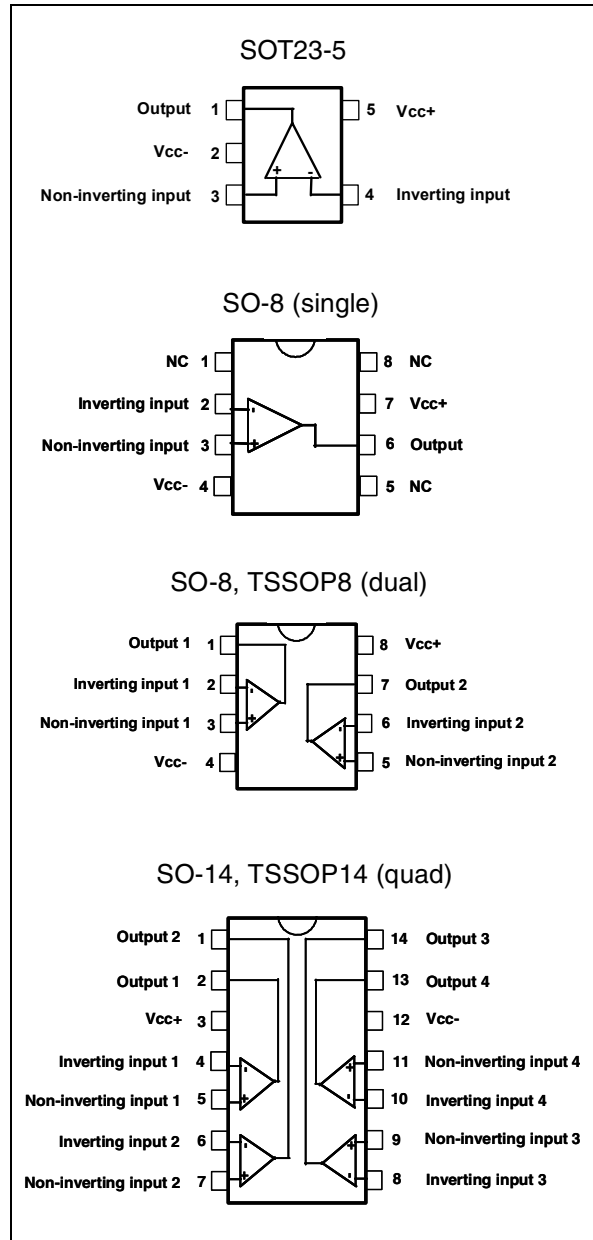

1 Absolute maximum ratings and operating conditions

Table 1. Absolute maximum ratings

Symbol	Parameter	Value	Unit
V _{CC}	Supply voltage ⁽¹⁾	12	V
V _{ID}	Differential input voltage ⁽²⁾	±12	V
V _{IN}	Input voltage range ⁽³⁾	-0.3 to 12.3	V
R _{THJA}	Thermal resistance junction-to-ambient ⁽⁴⁾		
	SOT23-5	250	°C/W
	SO-8	125	
	SO-14	105	
	TSSOP8	120	
TSSOP14	100		
R _{THJC}	Thermal resistance junction-to-case ⁽⁴⁾		
	SOT23-5	81	°C/W
	SO-8	40	
	SO-14	31	
	TSSOP8	37	
TSSOP14	32		
T _{STG}	Storage temperature range	-65 to +150	°C
T _J	Maximum junction temperature	150	°C
T _{LEAD}	Lead temperature (soldering, 10 sec.)	260	°C
ESD	Human body model (HBM) ⁽⁵⁾	2	kV
	Machine model (MM) ⁽⁶⁾	200	V
	Latch-up immunity	Class A	

1. All voltages values, except differential voltage are with respect to network terminal.
2. Differential voltages are non-inverting input terminal with respect to the inverting input terminal.
3. The magnitude of input and output voltages must never exceed V_{CC} +0.3 V.
4. Short-circuits can cause excessive heating. These values are typical.
5. Human body model: a 100 pF capacitor is charged to the specified voltage, then discharged through a 1.5 kΩ resistor between two pins of the device. This is done for all couples of connected pin combinations while the other pins are floating.
6. Machine model: a 200 pF capacitor is charged to the specified voltage, then discharged directly between two pins of the device with no external series resistor (internal resistor < 5 Ω). This is done for all couples of connected pin combinations while the other pins are floating.

Table 2. Operating conditions

Symbol	Parameter	Value	Unit
V _{CC}	Supply voltage	2.7 to 10	V
V _{ICM}	Common mode input voltage range	V _{CC} ⁻ - 0.3 to V _{CC} ⁺ + 0.3	V
T _{Oper}	Operating free air temperature range	-40 to + 85	°C

2 Electrical characteristics

**Table 3. Electrical characteristics at $V_{CC} = 2.7\text{ V}$, $T_{amb} = 25\text{ °C}$
(unless otherwise specified)**

Symbol	Parameter	Min.	Typ.	Max.	Unit
V_{IO}	Input offset voltage TS861/2/4 $T_{min} < T < T_{max}$		3	15 18	mV
	TS861/2/4A $T_{min} < T < T_{max}$		3	7 10	
ΔV_{IO}	Input offset voltage drift		6		$\mu\text{V}/\text{°C}$
I_{IO}	Input offset current ⁽¹⁾ $T_{min} < T < T_{max}$		1	150 300	pA
I_{IB}	Input bias current ⁽¹⁾ $T_{min} < T < T_{max}$		1	300 600	pA
V_{OH}	High level output voltage $I_{SOURCE} = 2.5\text{ mA}$ $T_{min} < T < T_{max}$	2.35 2.15	2.45		V
V_{OL}	Low level output voltage $I_{SINK} = 2.5\text{ mA}$ $T_{min} < T < T_{max}$		0.2	0.35 0.45	V
A_{VD}	Large signal voltage gain ⁽²⁾		240		dB
CMR	Common mode rejection ratio $0 < V_{ICM} < 2.7\text{ V}$		65		dB
SVR	Supply voltage rejection ratio $0 < V_{CC} < 10\text{ V}$		80		dB
I_{CC}	Supply current per comparator No load, output low		6	12	μA
	No load, output high		8	14	
T_{PLH}	Propagation delay from output low to output high $V_{ICM} = 1.35\text{ V}$, $f = 10\text{ kHz}$, $C_L = 50\text{ pF}$ Overdrive = 10 mV Overdrive = 100 mV		1.5 0.6		μs
T_{PHL}	Propagation delay from output high to output low $V_{ICM} = 1.35\text{ V}$, $f = 10\text{ kHz}$, $C_L = 50\text{ pF}$ Overdrive = 10 mV Overdrive = 100 mV		1.5 0.5		μs

**Table 3. Electrical characteristics at $V_{CC} = 2.7\text{ V}$, $T_{amb} = 25\text{ °C}$
(unless otherwise specified) (continued)**

Symbol	Parameter	Min.	Typ.	Max.	Unit
T_F	Fall time f = 10 kHz, $C_L = 50\text{ pF}$, overdrive = 100 mV		20		ns
T_R	Rise time f = 10 kHz, $C_L = 50\text{ pF}$, overdrive = 100 mV		20		ns

1. Maximum values including unavoidable inaccuracies of the industrial tests.
2. Design evaluation.

Note: *Limits are 100% production tested at 25 °C. Limits over temperature are guaranteed through correlation and by design.*

Table 4. Electrical characteristics at $V_{CC} = 5\text{ V}$, $T_{amb} = 25\text{ °C}$ (unless otherwise specified)

Symbol	Parameter	Min.	Typ.	Max.	Unit
V_{IO}	Input offset voltage TS861/2/4 $T_{min} < T < T_{max}$		3	15 18	mV
	TS861/2/4A $T_{min} < T < T_{max}$		3	7 10	
ΔV_{IO}	Input offset voltage drift		6		$\mu\text{V}/\text{°C}$
I_{IO}	Input offset current ⁽¹⁾ $T_{min} < T < T_{max}$		1	150 300	pA
I_{IB}	Input bias current ⁽¹⁾ $T_{min} < T < T_{max}$		1	300 600	pA
V_{OH}	High level output voltage $I_{SOURCE} = 5\text{ mA}$ $T_{min} < T < T_{max}$	4.6 4.45	4.8		V
V_{OL}	Low level output voltage $I_{SINK} = 5\text{ mA}$ $T_{min} < T < T_{max}$		0.2	0.4 0.55	V
A_{VD}	Large signal voltage gain ⁽²⁾		240		dB
CMR	Common mode rejection ratio $0 < V_{ICM} < 5\text{ V}$		70		dB
SVR	Supply voltage rejection ratio $2.7 < V_{CC} < 10\text{ V}$		80		dB
I_{CC}	Supply current per comparator				μA
	No load, output low No load, output high		6 8	12 14	
T_{PLH}	Propagation delay from output low to output high $V_{ICM} = 2.5\text{ V}$, $f = 10\text{ kHz}$, $C_L = 50\text{ pF}$ Overdrive = 10 mV Overdrive = 100 mV		2 0.5		μs
	Propagation delay from output high to output low $V_{ICM} = 2.5\text{ V}$, $f = 10\text{ kHz}$, $C_L = 50\text{ pF}$ Overdrive = 10 mV Overdrive = 100 mV		2 0.4		
T_F	Fall time $f = 10\text{ kHz}$, $C_L = 50\text{ pF}$, overdrive = 100 mV		20		ns
T_R	Rise time $f = 10\text{ kHz}$, $C_L = 50\text{ pF}$, overdrive = 100 mV		20		ns

1. Maximum values including unavoidable inaccuracies of the industrial test.

2. Design evaluation.

Note: Limits are 100% production tested at 25 °C. Limits over temperature are guaranteed through correlation and by design.

Table 5. Electrical characteristics at $V_{CC} = +10\text{ V}$, $T_{amb} = 25\text{ °C}$ (unless otherwise specified)

Symbol	Parameter	Min.	Typ.	Max.	Unit
V_{IO}	Input offset voltage ($V_{ICM} = V_{CC} / 2$) TS861/2/4 $T_{min} < T < T_{max}$		3	15 18	mV
ΔV_{IO}	Input offset voltage drift		6		$\mu\text{V}/\text{°C}$
I_{IO}	Input offset current ⁽¹⁾ $T_{min} < T < T_{max}$		1	150 300	pA
I_{IB}	Input bias current ⁽¹⁾ $T_{min} < T < T_{max}$		1	300 600	pA
V_{OH}	High level output voltage $I_{SOURCE} = 5\text{ mA}$ $T_{min} < T < T_{max}$	9.6 9.45	9.8		V
V_{OL}	Low level output voltage $I_{SINK} = 5\text{ mA}$ $T_{min} < T < T_{max}$		0.2	0.4 0.55	V
A_{VD}	Large signal voltage gain ⁽²⁾		240		dB
CMR	Common mode rejection ratio $0 < V_{ICM} < 10\text{ V}$		75		dB
SVR	Supply voltage rejection ratio $2.7 < V_{CC} < 10\text{ V}$		80		dB
I_{CC}	Supply current per comparator No load, output low No load, output high		7 10	14 16	μA
T_{PLH}	Propagation delay from output low to output high $V_{ICM} = 5\text{ V}$, $f = 10\text{ kHz}$, $C_L = 50\text{ pF}$ Overdrive = 10 mV Overdrive = 100 mV		3 0.5		μs
T_{PHL}	Propagation delay from output high to output low $V_{ICM} = 5\text{ V}$, $f = 10\text{ kHz}$, $C_L = 50\text{ pF}$ Overdrive = 10 mV Overdrive = 100 mV		2.6 0.4		μs
T_F	Fall time $f = 10\text{ kHz}$, $C_L = 50\text{ pF}$, overdrive = 100 mV		20		ns
T_R	Rise time $f = 10\text{ kHz}$, $C_L = 50\text{ pF}$, overdrive = 100 mV		20		ns

1. Maximum values including unavoidable inaccuracies of the industrial test.

2. Design evaluation.

Note: Limits are 100% production tested at 25 °C. Limits over temperature are guaranteed through correlation and by design.

Figure 1. V_{IO} vs. V_{ICM} at $V_{CC} = 2.7\text{ V}$

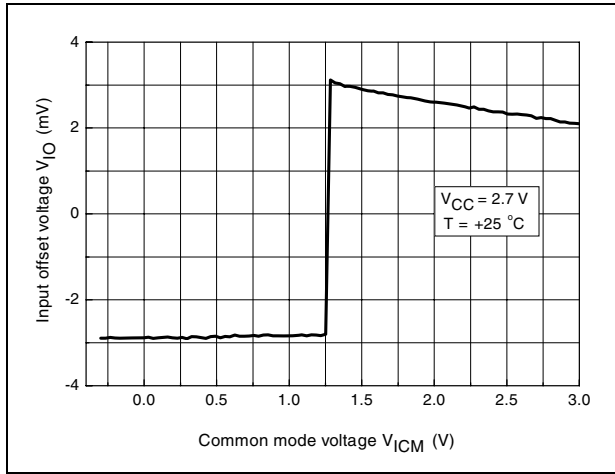

Figure 2. V_{IO} vs. V_{ICM} and temperature at $V_{CC} = 2.7\text{ V}$

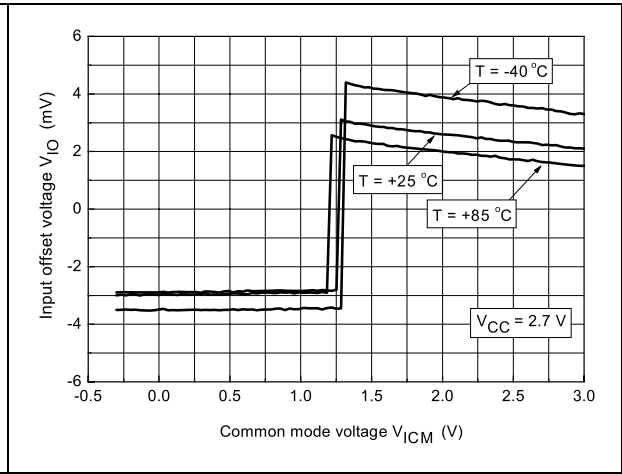

Figure 3. V_{IO} vs. V_{ICM} at $V_{CC} = 5\text{ V}$

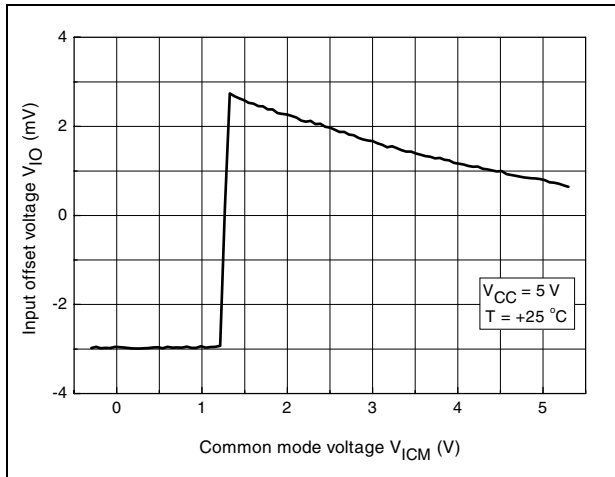

Figure 4. V_{IO} vs. V_{ICM} and temperature at $V_{CC} = 5\text{ V}$

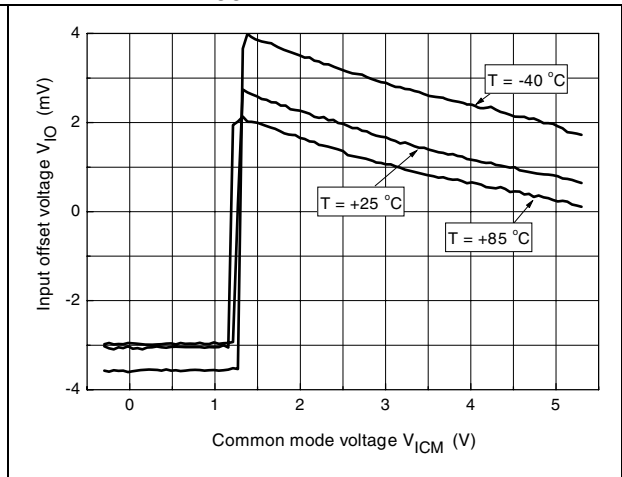

Figure 5. V_{IO} vs. V_{ICM} at $V_{CC} = 10\text{ V}$

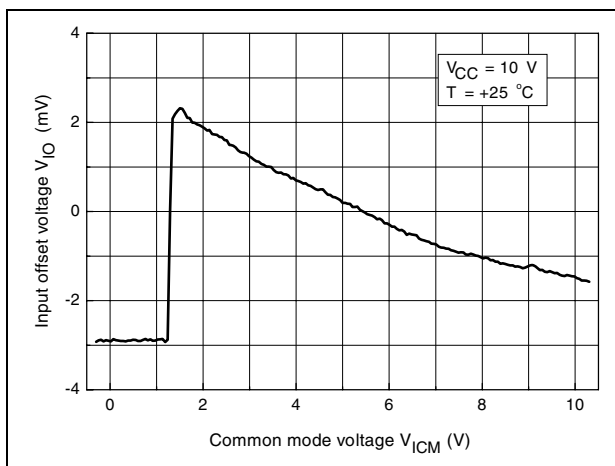

Figure 6. V_{IO} vs. V_{ICM} and temperature at $V_{CC} = 10\text{ V}$

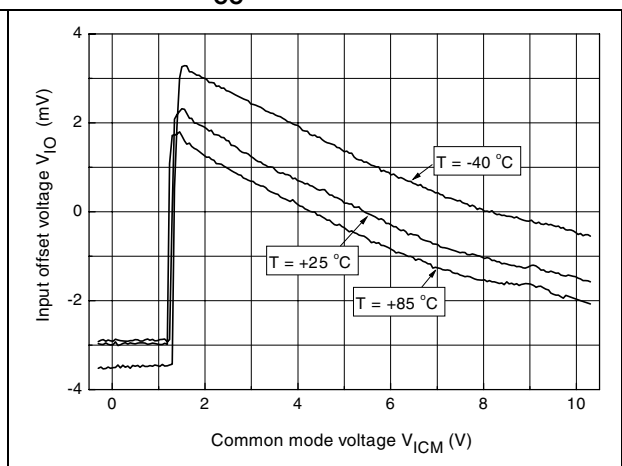

Figure 7. V_{IO} vs. V_{CC} at $V_{ICM} = V_{CC}/2$



Figure 8. V_{IO} vs. temperature at $V_{CC} = 5$ V



Figure 9. Supply current (I_{CC}) vs. supply voltage (V_{CC}) ($V_{ID} = -1$ V)



Figure 10. Supply current (I_{CC}) vs. supply voltage (V_{CC}) ($V_{ID} = +1$ V)



Figure 11. Supply current (I_{CC}) vs. temperature ($V_{ID} = -1$ V)



Figure 12. Supply current (I_{CC}) vs. temperature ($V_{ID} = +1$ V)

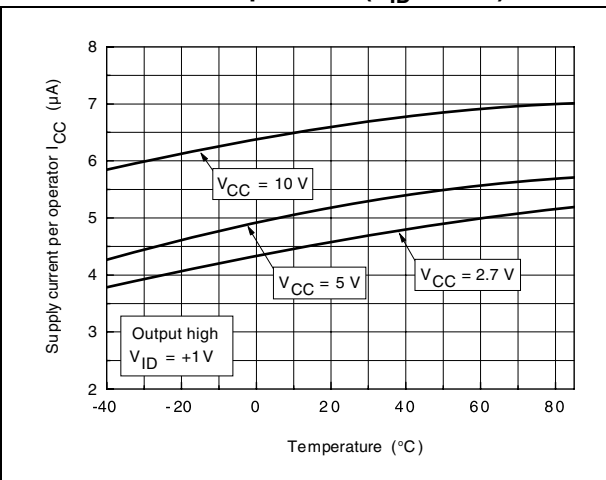

Figure 13. V_{OL} vs. I_{SINK} and temperature at $V_{CC} = 5\text{ V}$



Figure 14. V_{OH} vs. I_{SOURCE} and temperature at $V_{CC} = 5\text{ V}$



Figure 15. Propagation delay T_{PLH} vs. V_{ICM} with $V_{OVD} = 100\text{ mV}$



Figure 16. Propagation delay T_{PHL} vs. V_{ICM} with $V_{OVD} = 100\text{ mV}$



Figure 17. Propagation delay T_{PLH} vs. V_{ICM} with $V_{OVD} = 10\text{ mV}$



Figure 18. Propagation delay T_{PHL} vs. V_{ICM} with $V_{OVD} = 10\text{ mV}$



Figure 19. Propagation delay vs. V_{CC} with $V_{OVD} = 10\text{ mV}$



Figure 20. Propagation delay vs. V_{CC} with $V_{OVD} = 100\text{ mV}$

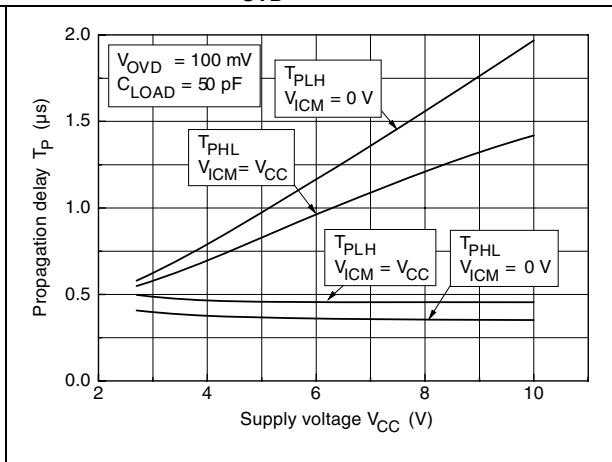

Figure 21. Propagation delay vs. overdrive voltage at $V_{CC} = 2.7\text{ V}$



Figure 22. Propagation delay vs. overdrive voltage at $V_{CC} = 5\text{ V}$

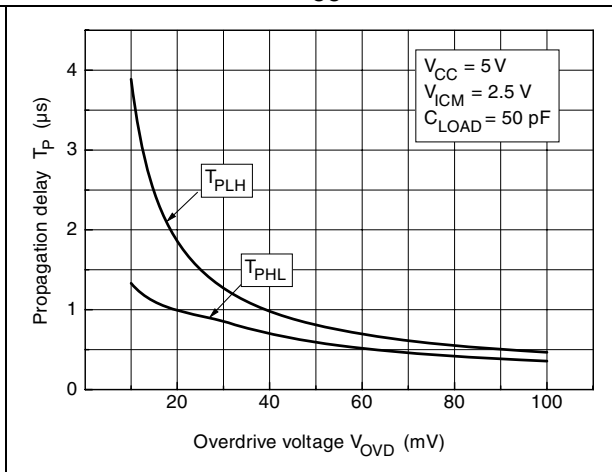
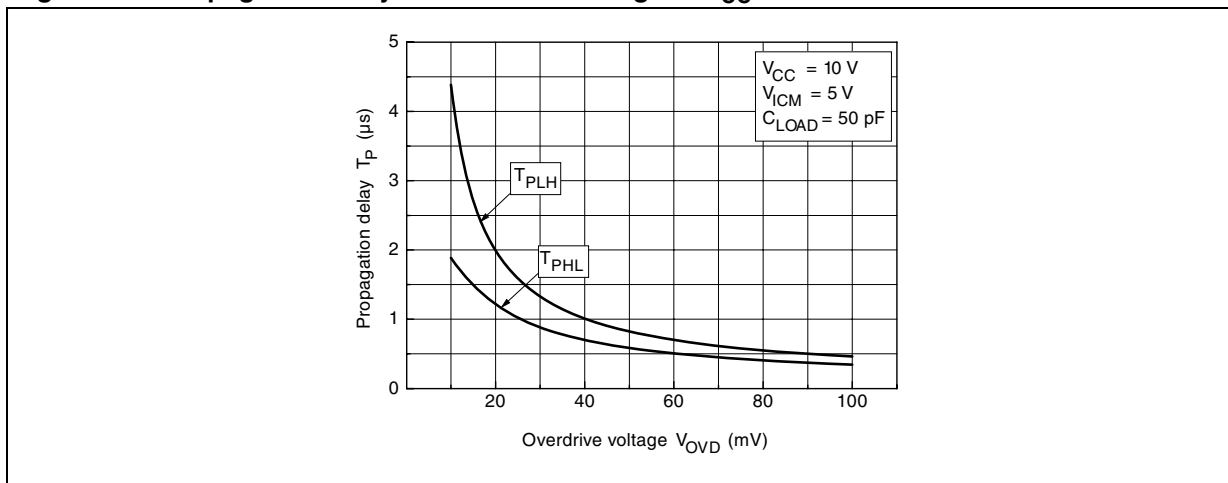

Figure 23. Propagation delay vs. overdrive voltage at $V_{CC} = 10\text{ V}$



3 Package information

In order to meet environmental requirements, ST offers these devices in different grades of ECOPACK® packages, depending on their level of environmental compliance. ECOPACK specifications, grade definitions and product status are available at: www.st.com. ECOPACK is an ST trademark.

3.1 SOT23-5 package information

Figure 24. SOT23-5L package outline

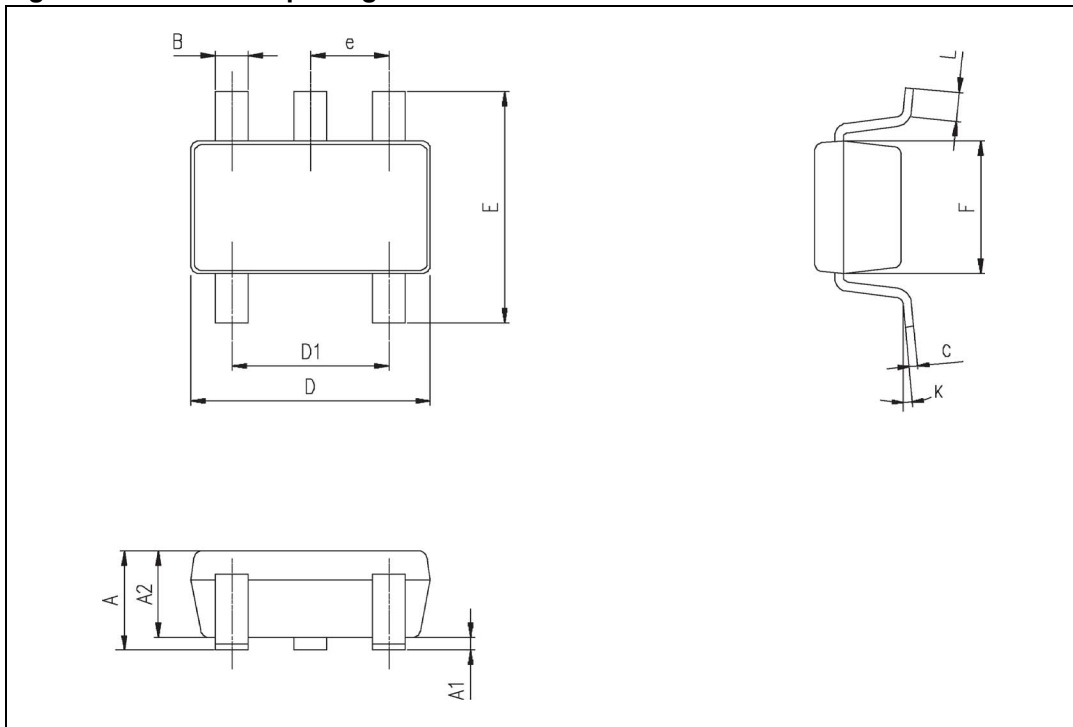

Table 6. SOT23-5L package mechanical data

Symbol	Dimensions					
	Millimeters			Inches		
	Min.	Typ.	Max.	Min.	Typ.	Max.
A	0.90	1.20	1.45	0.035	0.047	0.057
A1			0.15			0.006
A2	0.90	1.05	1.30	0.035	0.041	0.051
B	0.35	0.40	0.50	0.013	0.015	0.019
C	0.09	0.15	0.20	0.003	0.006	0.008
D	2.80	2.90	3.00	0.110	0.114	0.118
D1		1.90			0.075	
e		0.95			0.037	
E	2.60	2.80	3.00	0.102	0.110	0.118
F	1.50	1.60	1.75	0.059	0.063	0.069
L	0.10	0.35	0.60	0.004	0.013	0.023
K	0°		10°			

3.2 SO-8 package information

Figure 25. SO-8 package outline



Table 7. SO-8 package mechanical data

Symbol	Dimensions					
	Millimeters			Inches		
	Min.	Typ.	Max.	Min.	Typ.	Max.
A			1.75			0.069
A1	0.10		0.25	0.004		0.010
A2	1.25			0.049		
b	0.28		0.48	0.011		0.019
c	0.17		0.23	0.007		0.010
D	4.80	4.90	5.00	0.189	0.193	0.197
E	5.80	6.00	6.20	0.228	0.236	0.244
E1	3.80	3.90	4.00	0.150	0.154	0.157
e		1.27			0.050	
h	0.25		0.50	0.010		0.020
L	0.40		1.27	0.016		0.050
L1		1.04			0.040	
k	0		8°	1°		8°
ccc			0.10			0.004

3.3 SO-14 package information

Figure 26. SO-14 package outline



Table 8. SO-14 package mechanical data

Symbol	Dimensions					
	Millimeters			Inches		
	Min.	Typ.	Max.	Min.	Typ.	Max.
A	1.35		1.75	0.05		0.068
A1	0.10		0.25	0.004		0.009
A2	1.10		1.65	0.04		0.06
B	0.33		0.51	0.01		0.02
C	0.19		0.25	0.007		0.009
D	8.55		8.75	0.33		0.34
E	3.80		4.0	0.15		0.15
e		1.27			0.05	
H	5.80		6.20	0.22		0.24
h	0.25		0.50	0.009		0.02
L	0.40		1.27	0.015		0.05
k	8° (max.)					
ddd			0.10			0.004

3.4 TSSOP8 package information

Figure 27. TSSOP8 package outline

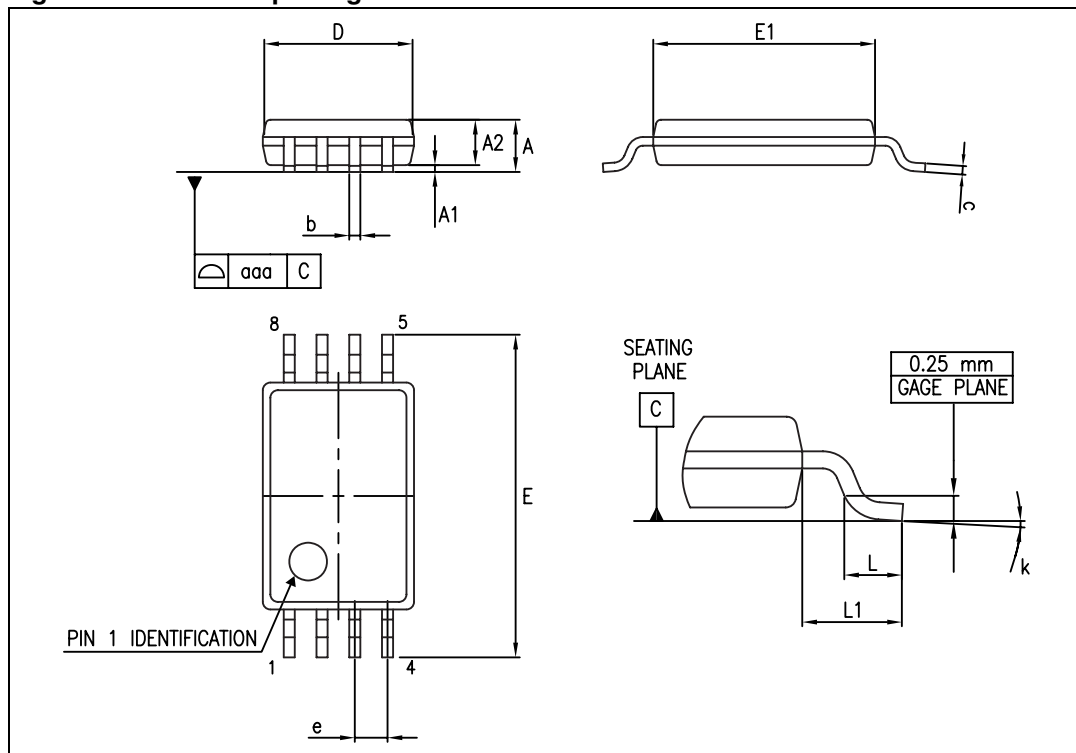

Table 9. TSSOP8 package mechanical data

Symbol	Dimensions					
	Millimeters			Inches		
	Min.	Typ.	Max.	Min.	Typ.	Max.
A			1.20			0.047
A1	0.05		0.15	0.002		0.006
A2	0.80	1.00	1.05	0.031	0.039	0.041
b	0.19		0.30	0.007		0.012
c	0.09		0.20	0.004		0.008
D	2.90	3.00	3.10	0.114	0.118	0.122
E	6.20	6.40	6.60	0.244	0.252	0.260
E1	4.30	4.40	4.50	0.169	0.173	0.177
e		0.65			0.0256	
k	0°		8°	0°		8°
L	0.45	0.60	0.75	0.018	0.024	0.030
L1		1			0.039	
aaa			0.10			0.004

3.5 TSSOP14 package information

Figure 28. TSSOP14 package outline



Table 10. TSSOP14 package mechanical data

Symbol	Dimensions					
	Millimeters			Inches		
	Min.	Typ.	Max.	Min.	Typ.	Max.
A			1.20			0.047
A1	0.05		0.15	0.002	0.004	0.006
A2	0.80	1.00	1.05	0.031	0.039	0.041
b	0.19		0.30	0.007		0.012
c	0.09		0.20	0.004		0.0089
D	4.90	5.00	5.10	0.193	0.197	0.201
E	6.20	6.40	6.60	0.244	0.252	0.260
E1	4.30	4.40	4.50	0.169	0.173	0.176
e		0.65			0.0256	
L	0.45	0.60	0.75	0.018	0.024	0.030
L1		1.00			0.039	
k	0°		8°	0°		8°
aaa			0.10			0.004

4 Ordering information

Table 11. Order codes

Part number	Temperature range	Package	Packaging	Marking
TS861ILT TS861AILT	-40 °C, +85 °C	SOT-23	Tape and reel	K501 K502
TS861ID TS861IDT		SO-8	Tube Tape and reel	861I
TS861AID TS861AIDT			Tube Tape and reel	861AI
TS862ID TS862IDT	-40 °C, +85 °C	SO-8	Tube Tape and reel	862I
TS862AID TS862AIDT			Tube Tape and reel	862AI
TS862IPT TS862AIPT		TSSOP8	Tape and reel	862I 862AI
TS864ID TS864IDT	-40 °C, +85 °C	SO-14	Tube Tape and reel	864I
TS864AID TS864AIDT			Tube Tape and reel	864AI
TS864IPT TS864AIPT		TSSOP14	Tape and reel	864I 864AI

5 Revision history

Table 12. Document revision history

Date	Revision	Changes
01-Feb-2002	1	Initial release.
28-Apr-2009	2	Updated document format. Removed power dissipation from Table 1: Absolute maximum ratings . Added Rthja and Rthjc values and ESD notes in Table 1 . Updated curves in Figure 1 to Figure 14 . Changed Figure 15 , Figure 16 , Figure 17 and Figure 18 . Added Figure 19 , Figure 20 , Figure 21 , Figure 22 and Figure 23 . Removed DIP package information in Chapter 3 and Chapter 4 . Added ordering information in Table 11: Order codes .
06-Nov-2012	3	Updated titles of Figure 9 to Figure 12 (added conditions). Removed TS861IYLT, TS861AIYLT, TS862IYDT, TS862AIYDT, TS864IYDT, and TS864AIYDT order codes from Table 11 . Minor corrections throughout document.

Please Read Carefully:

Information in this document is provided solely in connection with ST products. STMicroelectronics NV and its subsidiaries ("ST") reserve the right to make changes, corrections, modifications or improvements, to this document, and the products and services described herein at any time, without notice.

All ST products are sold pursuant to ST's terms and conditions of sale.

Purchasers are solely responsible for the choice, selection and use of the ST products and services described herein, and ST assumes no liability whatsoever relating to the choice, selection or use of the ST products and services described herein.

No license, express or implied, by estoppel or otherwise, to any intellectual property rights is granted under this document. If any part of this document refers to any third party products or services it shall not be deemed a license grant by ST for the use of such third party products or services, or any intellectual property contained therein or considered as a warranty covering the use in any manner whatsoever of such third party products or services or any intellectual property contained therein.

UNLESS OTHERWISE SET FORTH IN ST'S TERMS AND CONDITIONS OF SALE ST DISCLAIMS ANY EXPRESS OR IMPLIED WARRANTY WITH RESPECT TO THE USE AND/OR SALE OF ST PRODUCTS INCLUDING WITHOUT LIMITATION IMPLIED WARRANTIES OF MERCHANTABILITY, FITNESS FOR A PARTICULAR PURPOSE (AND THEIR EQUIVALENTS UNDER THE LAWS OF ANY JURISDICTION), OR INFRINGEMENT OF ANY PATENT, COPYRIGHT OR OTHER INTELLECTUAL PROPERTY RIGHT.

UNLESS EXPRESSLY APPROVED IN WRITING BY TWO AUTHORIZED ST REPRESENTATIVES, ST PRODUCTS ARE NOT RECOMMENDED, AUTHORIZED OR WARRANTED FOR USE IN MILITARY, AIR CRAFT, SPACE, LIFE SAVING, OR LIFE SUSTAINING APPLICATIONS, NOR IN PRODUCTS OR SYSTEMS WHERE FAILURE OR MALFUNCTION MAY RESULT IN PERSONAL INJURY, DEATH, OR SEVERE PROPERTY OR ENVIRONMENTAL DAMAGE. ST PRODUCTS WHICH ARE NOT SPECIFIED AS "AUTOMOTIVE GRADE" MAY ONLY BE USED IN AUTOMOTIVE APPLICATIONS AT USER'S OWN RISK.

Resale of ST products with provisions different from the statements and/or technical features set forth in this document shall immediately void any warranty granted by ST for the ST product or service described herein and shall not create or extend in any manner whatsoever, any liability of ST.

ST and the ST logo are trademarks or registered trademarks of ST in various countries.

Information in this document supersedes and replaces all information previously supplied.

The ST logo is a registered trademark of STMicroelectronics. All other names are the property of their respective owners.

© 2012 STMicroelectronics - All rights reserved

STMicroelectronics group of companies

Australia - Belgium - Brazil - Canada - China - Czech Republic - Finland - France - Germany - Hong Kong - India - Israel - Italy - Japan - Malaysia - Malta - Morocco - Philippines - Singapore - Spain - Sweden - Switzerland - United Kingdom - United States of America

www.st.com

