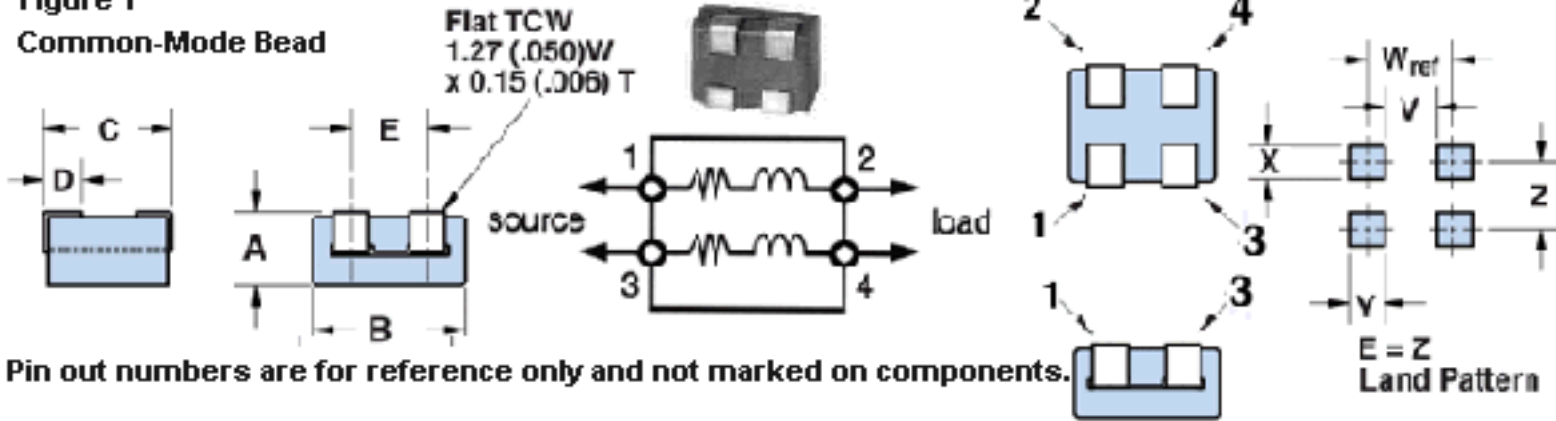



Figure 1

Common-Mode Bead



Part Number: 2744045446
 Frequency Range: Broadband Frequencies 10-300 MHz (44 material)
 Description: 44 COMMON MODE SM BEAD
 Application: Suppression Components
 Where Used: Board Component
 Part Type: SM Beads (Common-Mode)

Mechanical Specifications

Weight: .530 (g)

Part Type Information

Surface mount common-mode beads are available from Fair-Rite in several materials and sizes. The common-mode bead provides a common magnetic path for the flux generated by the current to the load and the return current from the load. The current compensation results in zero magnetic flux in the bead.

-SM Beads on 12 mm tape width are supplied taped and reeled per EIA 481 and IEC 60286-3 standards. SM Beads on 16 and 24 mm tape widths are supplied taped and reeled per EIA 481 and IEC 60286-3 standards. Taped and reeled parts are supplied on a 13" reel.

-SM Beads can also be supplied not taped and reeled and then are bulk packed. This packing method will change the last digit of the part number to a '6'.

-Wires are oxygen free high conductivity copper with 100% matte tin plating over a nickel undercoating.

-SM Beads meet the solderability specifications when tested in accordance with MIL-STD-202, method 208. After dipping the mounting site of the bead, the solder surface shall be at least 95% covered with a smooth solder coating. The edges of the copper strip are not specified as solderable surfaces.

-After preheating the beads to within 100 oC of the soldering temperature, the parts meet the resistance to soldering requirements of EIA-186-10E, temperature 260 ± 5 oC and time 10 ± 1 seconds.

-Suggested land patterns are in accordance with the latest revision of IPC-7351.

-SM Beads are controlled for impedance limits only. Minimum impedance values are specified for the + marked frequencies. The minimum impedance is typically the listed value less 20%. SM Beads in 44 materials are measured for impedance on the 4193 Vector Impedance Analyzer. The 52 SM Beads are tested for impedance on the 4291A RF Impedance Analyzer.

-Recommended storage and operation temperature is -55 oC to 125 oC.

-The maximum current rating for these SM Beads is 5 amps.

-For any SM Bead requirement not listed, please contact our customer service group for availability and pricing.

-Our Surface Mount Bead Kit' (part number 0199000025) is available for prototype evaluation.

-Explanation of Part Numbers: Digits 1&2 = product class, 3&4 = material grade, last digit 6 = bulk packed, 7 = taped and reeled.

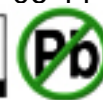

Mechanical Specifications

Dim	mm	mm tol	nominal inch	inch misc.
A	2.85	±0.20	0.112	-
B	5.60	±0.20	0.220	-
C	8.90	-0.80	0.335	-
D	1.35	±0.50	0.053	-
E	2.54	±0.25	0.100	-
F	-	-	-	-
G	-	-	-	-
H	-	-	-	-
J	-	-	-	-
K	-	-	-	-

Electrical Specifications

Typical Impedance (Ω)	
10 MHz	23
25 MHz+	38
100 MHz+	60
250 MHz	78
300 MHz	-

Electrical Properties	
Max Rdc(m Ω)	1.40

Land Patterns

V	W ref	X	Y	Z
4.000 0.158	7.000 0.276	1.800 0.071	3.000 0.118	2.540 0.100

Winding Information

Turns Tested	Wire Size	1st Wire Length	2nd Wire Length
-	-	-	-

Reel Information

Tape Width mm	Pitch mm	Parts 7 " Reel	Parts 13 " Reel	Parts 14 " Reel
-	-	-	-	-

Package Size

Pkg Size
- (-)

Connector Plate

# Holes	# Rows
-	-

Legend

+ Test frequency

Preferred parts, the suggested choice for new designs, have shorter lead times and are more readily available.

The column H(Oe) gives for each bead the calculated dc bias field in oersted for 1 turn and 1 ampere direct current. The actual dc H field in the application is this value of H times the actual NI (ampere-turn) product. For the effect of the dc bias on the impedance of the bead material, see figures 18-23 in the application note How to choose Ferrite Components for EMI Suppression.

A ½ turn is defined as a single pass through a hole.

Σ l/A - Core Constant

A_e - Effective Cross-Sectional Area

A_L - Inductance Factor ($\frac{L}{N^2}$)

N/AWG - Number of Turns/Wire Size for Test Coil

l_e - Effective Path Length

V_e - Effective Core Volume

NI - Value of dc Ampere-turns



Ferrite Material Constants

Specific Heat	0.25 cal/g/°C
Thermal Conductivity	3.5 - 4.5 mW/cm - °C
Coefficient of Linear Expansion	8 - 10x10 ⁻⁶ /°C
Tensile Strength	4.9 kgf/mm ²
Compressive Strength	42 kgf/mm ²
Young's Modulus	15x10 ³ kgf/mm ²
Hardness (Knoop)	650
Specific Gravity	≈ 4.7 g/cm ³

The above quoted properties are typical for Fair-Rite MnZn and NiZn ferrites.

See next page for further material specifications.



44 Material Characteristics:

Property	Unit	Symbol	Value
Initial Permeability @ B < 10 gauss		μ_i	500
Flux Density @ Field Strength	gauss oersted	B H	3000 10
Residual Flux Density	gauss	B_r	1100
Coercive Force	oersted	H_c	0.45
Loss Factor @ Frequency	10^{-6} MHz	$\tan \delta \mu_i$	125 1.0
Temperature Coefficient of Initial Permeability (20 -70°C)	%/°C		0.75
Curie Temperature	°C	T_c	>160
Resistivity	Ω cm	ρ	1×10^9

A NiZn ferrite developed to combine a high suppression performance, from 30 MHz to 500 MHz, with a very high dc resistivity.

SM beads, PC beads, wound beads, round cable snap-its, and connector EMI suppression plates are all available in 44 material.

Complex Permeability vs. Frequency

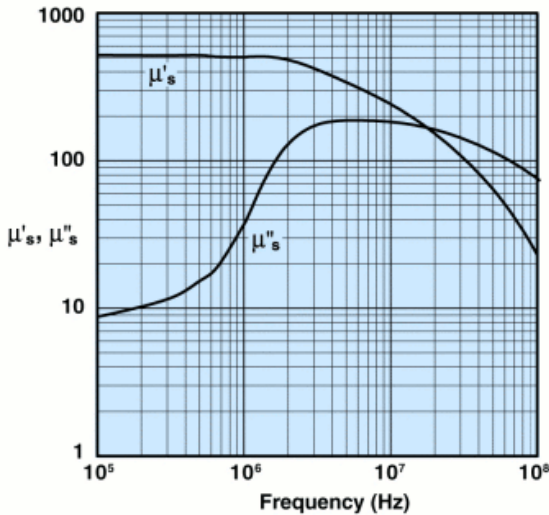

Measured on a 17/10/6mm toroid using the HP 4284A and the HP 4291A.

Percent of Original Impedance vs. Temperature

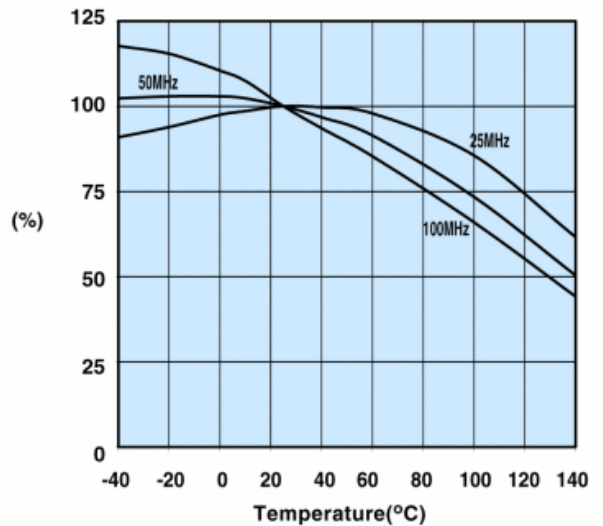

Measured on a 2644000301 using the HP4291A.

Initial Permeability vs. Temperature

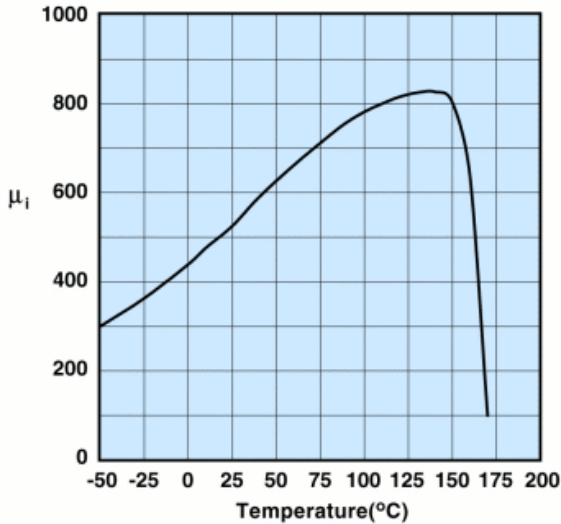

Measured on a 17/10/6mm toroid at 100kHz.

Hysteresis Loop

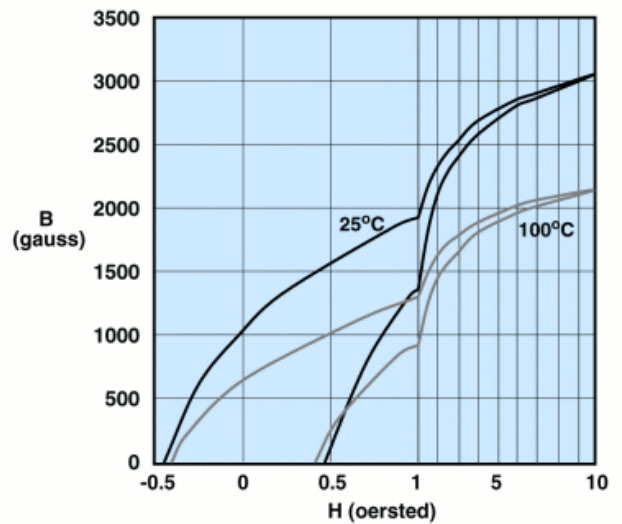

Measured on a 17/10/6mm toroid at 10kHz.



Fair-Rite Products Corp.
Your Signal Solution®

Ferrite Components for the Electronics Industry

Fair-Rite Products Corp. PO Box J, One Commercial Row, Wallkill, NY 12589-0288
Phone: (888) 324-7748 www.fair-rite.com

Fair-Rite Product's Catalog
Part Data Sheet, 2744045446
Printed: 2014-06-11



RoHS
Material
Declaration

2744045446

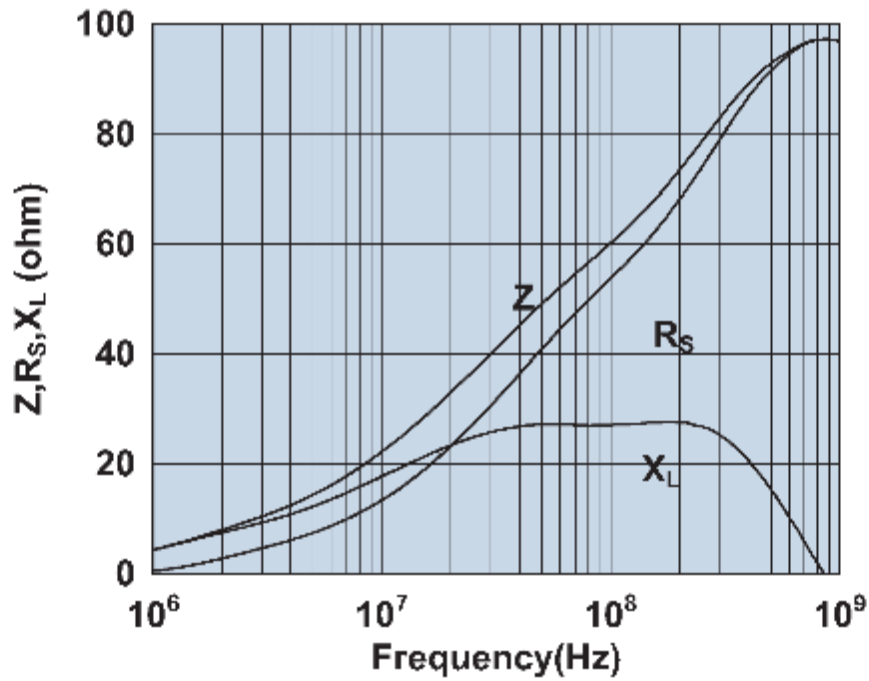

Impedance, reactance, and resistance vs. frequency.