

SERIES: CP50 | DESCRIPTION: PELTIER MODULE

FEATURES

- arcTEC™ structure on select models
- solid state device
- precise temperature control
- quiet operation



MODEL

MODEL	input voltage ¹ max (Vdc)	input current ² max (A)	internal resistance ³ typ ($\Omega \pm 10\%$)	output Qmax ⁴		output ΔT_{max} ⁵	
				T _h =27°C (W)	T _h =50°C (W)	T _h =27°C (°C)	T _h =50°C (°C)
CP50141	2.1	5.0	0.31	5.5	6.1	68	75
CP50241	3.8	5.0	0.56	10.0	11.1	68	75
CP50301541	4.2	5.0	0.63	11	12.3	68	75
CP5030395 ⁶	11.8	5.0	1.74	35.0	38.0	70	77
CP50341 ⁶	8.6	5.0	1.29	23.0	25.7	70	77
CP50441 ⁶	15.4	5.0	2.3	41.0	45.8	70	77

Notes:

1. Maximum voltage at ΔT_{max} and T_h=27°C
2. Maximum current to achieve ΔT_{max}
3. Measured by AC 4-terminal method at 25°C
4. Maximum heat absorbed at cold side occurs at I_{max'}, V_{max'}, and $\Delta T=0^\circ\text{C}$
5. Maximum temperature difference occurs at I_{max'}, V_{max'}, and Q=0W (ΔT_{max} measured in a vacuum at 1.3 Pa)
6. Designed with arcTEC™ structure

SPECIFICATIONS

parameter	conditions/description	min	typ	max	units
solder melting temperature	connection between thermoelectric pairs	235			°C
assembly compression				1	MPa
RoHS	yes				

MECHANICAL DRAWING

units: mm



	MATERIAL	PLATING
ceramic plate	96% Al_2O_3	
wire leads	20 AWG	tin
sealer	silicon rubber 703 RTV (between cold and hot side plates)	
joint cover	silicon rubber 703 RTV	
marking	P/N & S/N printed on cold side surface	

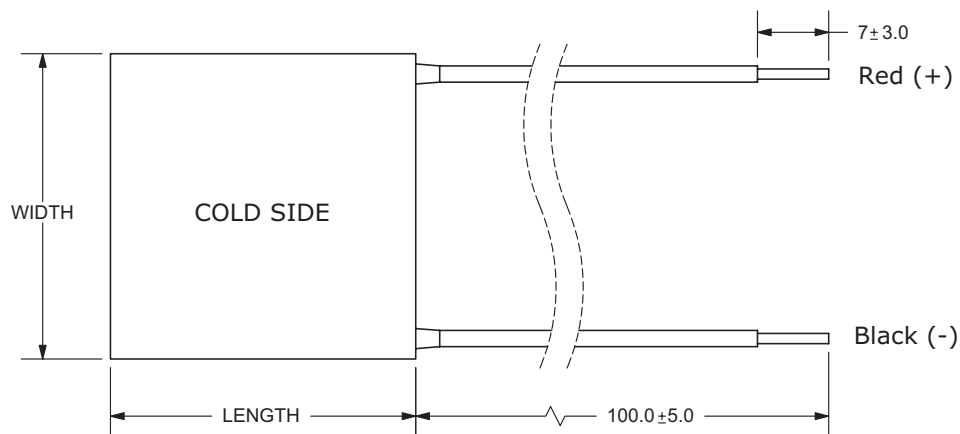

MODEL NO.	LENGTH (mm)	WIDTH (mm)	THICKNESS (mm)
CP50141	15 ±0.3	15 ±0.3	4.0 ±0.1
CP50241	20 ±0.3	20 ±0.3	4.0 ±0.1
CP50301541	30 ±0.3	15 ±0.3	4.0 ±0.1
CP5030395	30 ±0.3	30 ±0.3	3.95 ±0.025
CP50341 ¹	30 ±0.3	30 ±0.3	4.0 ±0.1
CP50441 ¹	40 ±0.3	40 ±0.3	4.0 ±0.1

Notes: 1. Wire lead strip length on models CP50341 & CP50441 is 10 ±3.0 mm.

CP50141 PERFORMANCE (Th=27°C)

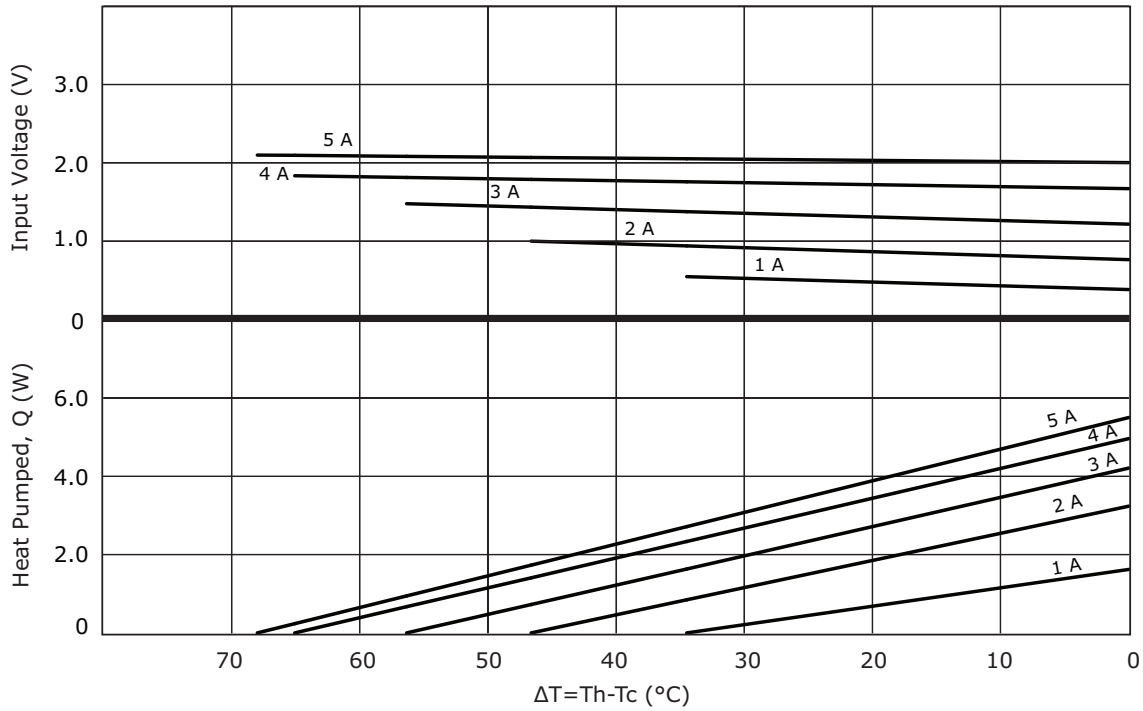

CP50141 PERFORMANCE (Th=50°C)

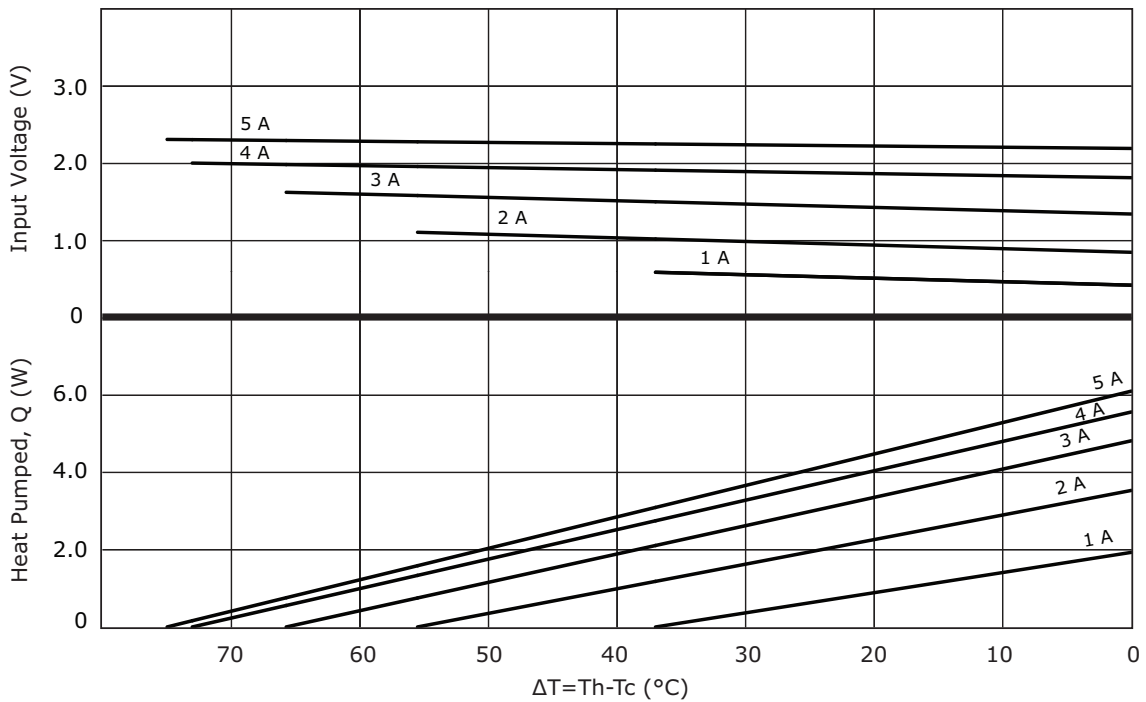

CP50241 PERFORMANCE (Th=27°C)

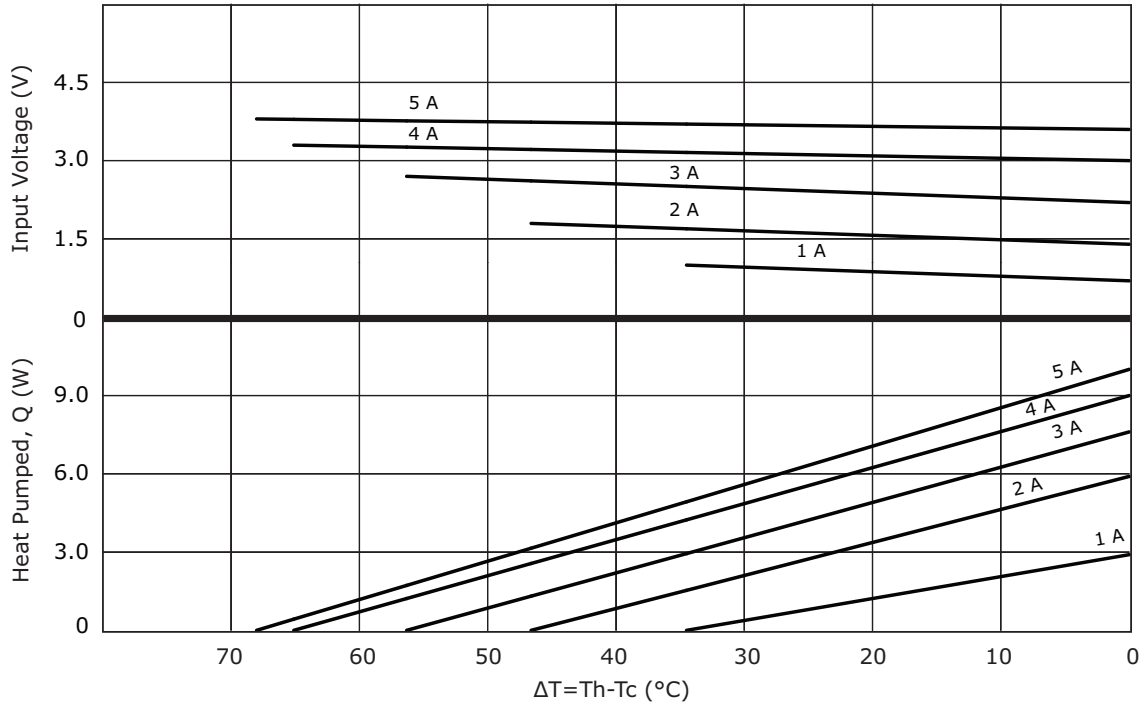

CP50241 PERFORMANCE (Th=50°C)

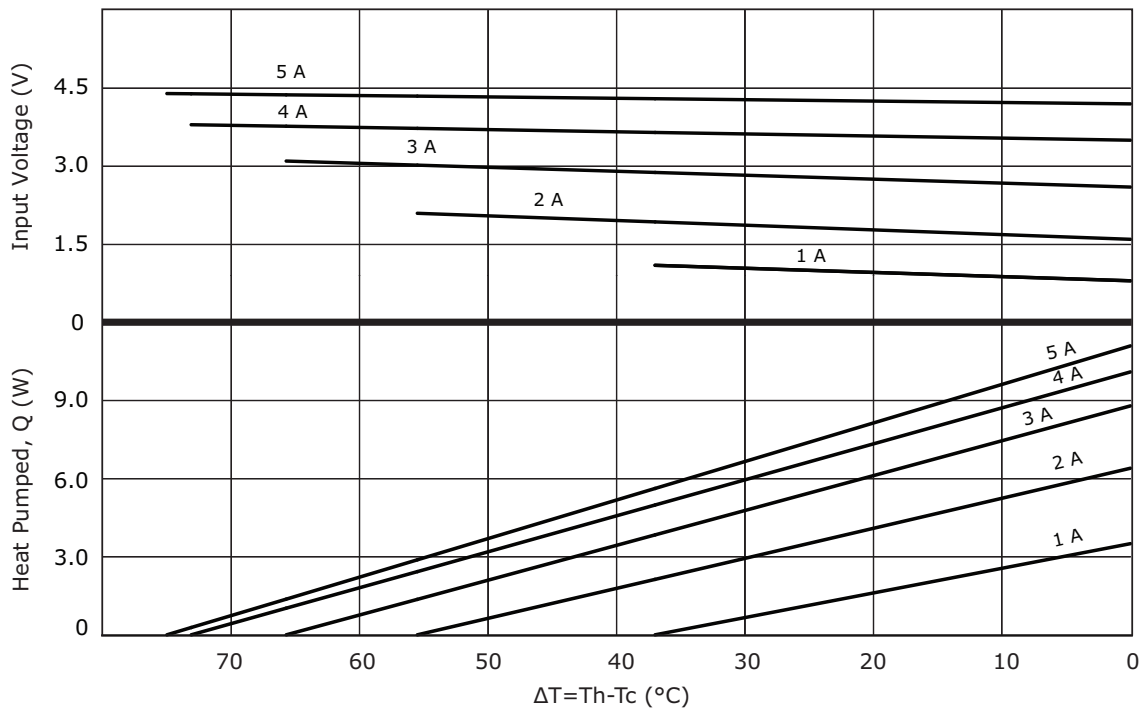

CP50301541 PERFORMANCE (Th=27°C)



CP50301541 PERFORMANCE (Th=50°C)



CP5030395 PERFORMANCE (Th=27°C)

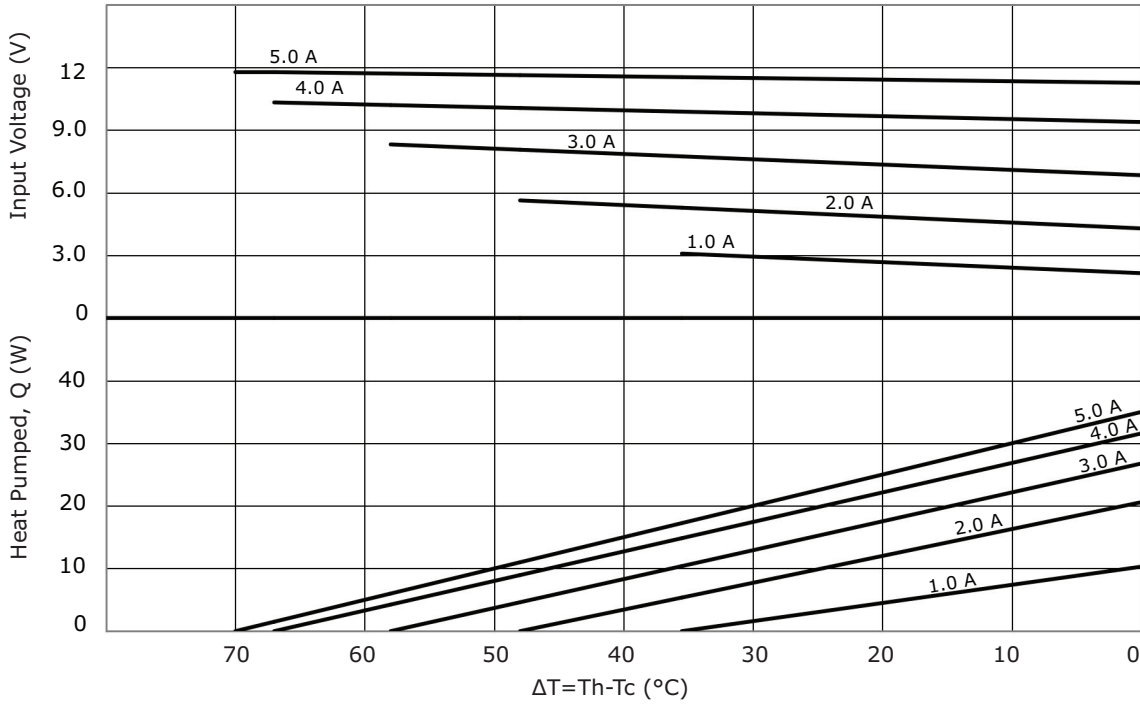

CP5030395 PERFORMANCE (Th=50°C)

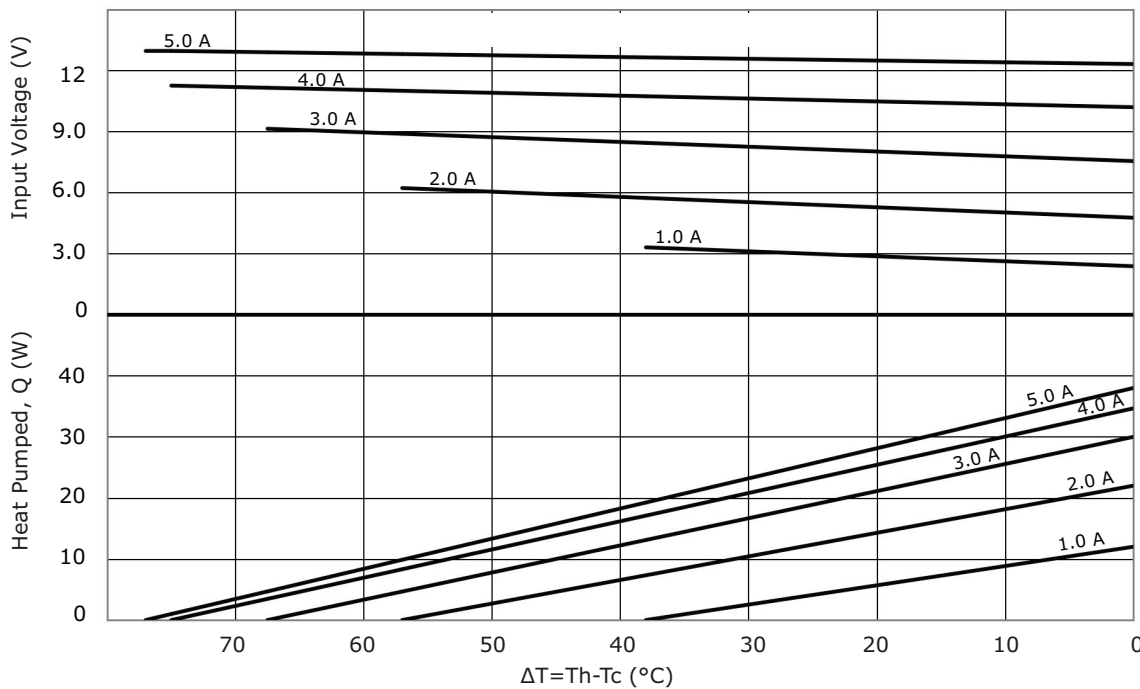

CP50341 PERFORMANCE (Th=27°C)

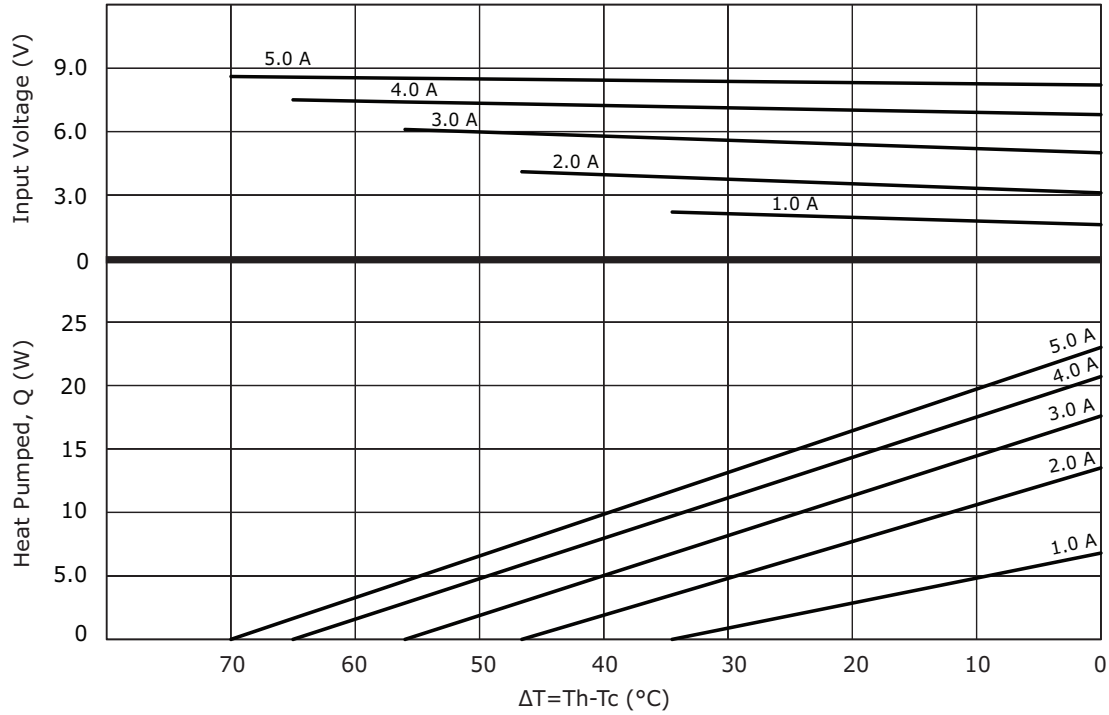

CP50341 PERFORMANCE (Th=50°C)



CP50441 PERFORMANCE (Th=27°C)



CP50441 PERFORMANCE (Th=50°C)



REVISION HISTORY

rev.	description	date
1.0	initial release	09/08/2016
1.01	changed models CP50341 & CP50441 to arcTEC™ structure	12/01/2017
1.02	changed thickness of CP50141, CP50241, CP50301541 models	09/20/2018
1.03	added model CP5030395, brand update	10/18/2019

The revision history provided is for informational purposes only and is believed to be accurate.

CUI DEVICES

CUI Devices offers a one (1) year limited warranty. Complete warranty information is listed on our website.

CUI Devices reserves the right to make changes to the product at any time without notice. Information provided by CUI Devices is believed to be accurate and reliable. However, no responsibility is assumed by CUI Devices for its use, nor for any infringements of patents or other rights of third parties which may result from its use.

CUI Devices products are not authorized or warranted for use as critical components in equipment that requires an extremely high level of reliability. A critical component is any component of a life support device or system whose failure to perform can be reasonably expected to cause the failure of the life support device or system, or to affect its safety or effectiveness.