

# ExaMAX<sup>®</sup>



EBTM-6-12-2.0-S-VT-1



EBTM-4-08-2.0-S-VT-1-L-G

(2.00 mm) .0787"

## ExaMAX<sup>®</sup> BACKPLANE SYSTEM

### SPECIFICATIONS

For complete specifications and recommended PCB layouts see [www.samtec.com?EBTM-VT](http://www.samtec.com?EBTM-VT) or [www.samtec.com?EBTM-RA](http://www.samtec.com?EBTM-RA)

**Insulator Material:** Liquid Crystal Polymer  
**Contact Material:** Copper Alloy

**Plating:** Sn or Au over 50 μm (1.27 μm) Ni  
**Operating Temp Range:** -55 °C to +85 °C  
**Current Rating:** 4.2 A per pin (1 pin powered)  
**Contact Wipe:** 2.4 mm  
**RoHS Compliant:** Yes

Mates with:  
EBTF-RA

PAM 4  
56 Gbps

### APPLICATION



2.00 mm column pitch

Provides exceptionally low mating force while maintaining excellent normal force



Press-fit termination

Two reliable points of contact with 2.4 mm wipe

### RECOGNITIONS

For complete scope of recognitions see [www.samtec.com/quality](http://www.samtec.com/quality)



EBTM

NO. OF PAIRS PER COLUMN

COLUMNS

COLUMN PITCH

-4 = 4 Pairs  
-6 = 6 Pairs

-06  
-08  
-10  
-12  
(-6 pairs only)

-2.0  
= (2.0 mm)  
.0787"

### ALSO AVAILABLE (MOQ Required)

- Staging

### TOOLING

- For press-fit extraction and insertion tool options, visit [www.samtec.com/tooling](http://www.samtec.com/tooling)

GUIDANCE (EBTM-VT)	KEYING							
	-A	-B	-C	-D	-E	-F	-G	-H
-L/-R								

COLUMNS	A	B	C
-06	(11.90) .469	(10.00) .394	(18.35) .722
-08	(15.90) .626	(14.00) .551	(22.35) .880
-10	(19.90) .783	(18.00) .709	(26.35) 1.037
-12	(23.90) .941	(22.00) .866	(30.35) 1.195

C (With Guidance)

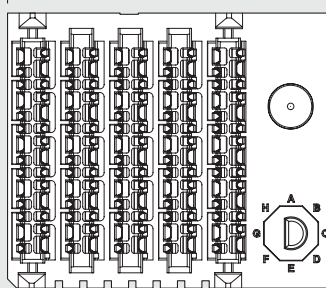

A (Without Guidance)

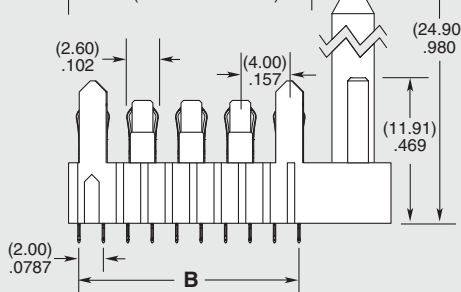

EBTM-4-10-2.0-S-VT-1-L-G SHOWN

NO. OF PAIRS PER COLUMN	D	E
-4	(22.50) .886	(15.60) .614
-6	(29.70) 1.169	(22.80) .898

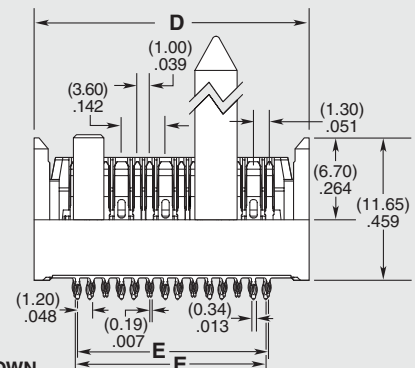

**Notes:** Some lengths, styles and options are non-standard, non-returnable.

ExaMAX<sup>®</sup> is a registered trademark of AFCL.

Due to technical progress, all designs, specifications and components are subject to change without notice.

[WWW.SAMTEC.COM](http://WWW.SAMTEC.COM)

All parts within this catalog are built to Samtec's specifications. Customer specific requirements must be approved by Samtec and identified in a Samtec customer-specific drawing to apply.

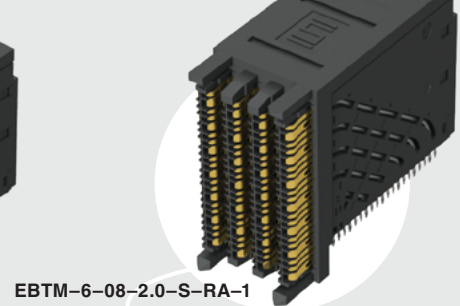

**EBTM-VT, EBTM-RA SERIES**

Guidance

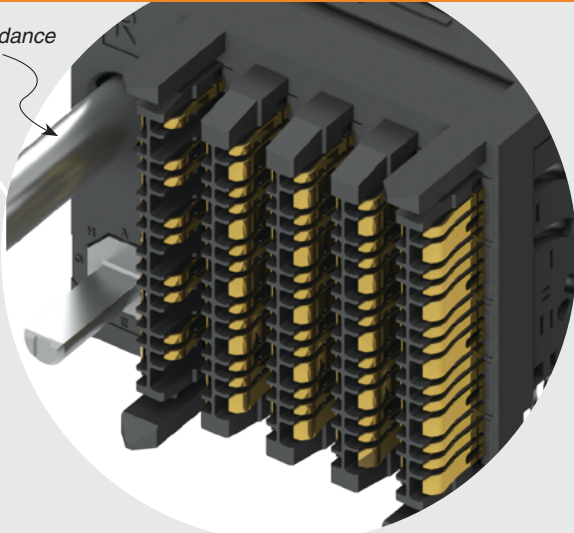

Press-fit termination

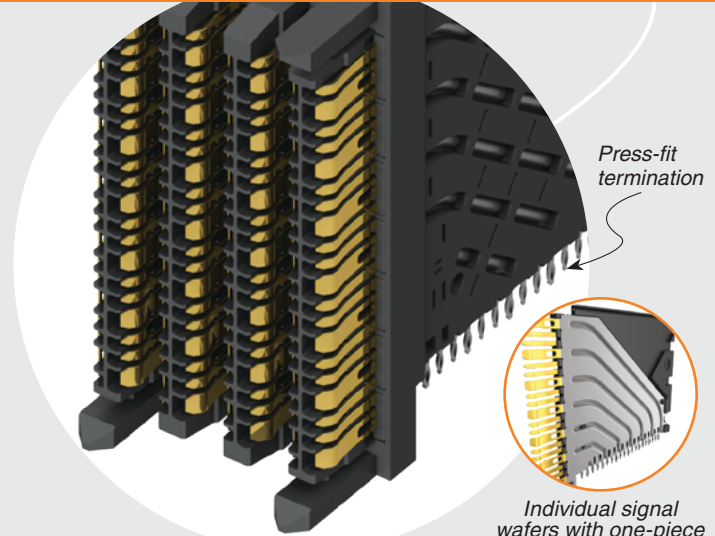

Individual signal wafers with one-piece ground plane

**PLATING**

**-S**  
= 30 μ" (0.76 μm)  
Gold on contact area,  
Matte Tin on tail

**ORIENTATION**

**-VT**  
= Vertical  
**-RA**  
= Right-angle

**1**

**GUIDANCE**

(Leave Blank for no Guidance)

**-L** = Left Guidance  
**-R** = Right Guidance

**KEYING**

(Only available with -L or -R guidance)

(Leave Blank for no keying)

**-A thru -H**  
= Position of flat on Key  
(See table for Key)

COLUMNS	A	B
-06	(11.90) .469	(18.35) .722
-08	(15.90) .626	(22.35) .880
-10	(19.90) .783	(26.35) 1.037
-12	(23.90) .941	(30.35) 1.195

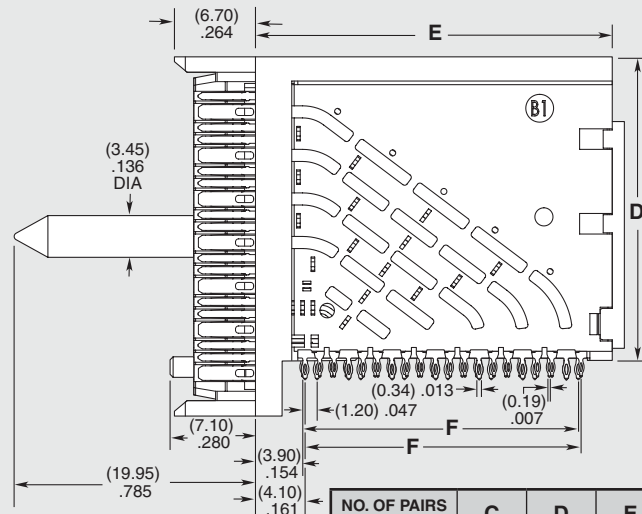
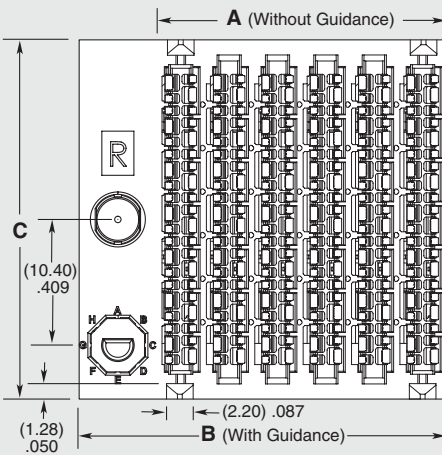

EBTM-6-12-2.0-S-RA-1-R-A SHOWN

GUIDANCE (EBTM-RA)	KEYING							
	-A	-B	-C	-D	-E	-F	-G	-H
-R / -L								

NO. OF PAIRS PER COLUMN	C	D	E	F
-4	(22.50) .886	(17.90) .705	(23.30) .917	(15.60) .614
-6	(29.70) 1.169	(25.10) .988	(30.50) 1.201	(22.80) .898

Due to technical progress, all designs, specifications and components are subject to change without notice.

[WWW.SAMTEC.COM](http://WWW.SAMTEC.COM)

All parts within this catalog are built to Samtec's specifications.  
Customer specific requirements must be approved by Samtec and identified in a Samtec customer-specific drawing to apply.