

Miniature Timer with Multiple Time Ranges and Multiple Operating Modes

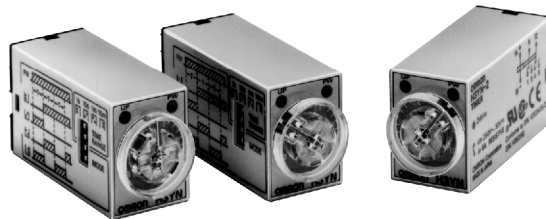

- Minimize Inventory
- Standard multiple operating modes and multiple time ranges
- 4PDT or DPDT control output
- LED power-ON and time-UP indicators
- Sockets, hold-down clips and mounting accessories may be ordered separately



Ordering Information

Supply voltage	Time-limit contact	Short-time range model (0.1 s to 10 min)	Long-time range model (0.1 min to 10 h)
24, 100 to 120, 200 to 230 VAC; 12, 24, 48, 100 to 110, 125 VDC	DPDT	H3YN-2	H3YN-21
	4PDT	H3YN-4	H3YN-41
24 VDC	4PDT (Twin contact)	H3YN-4-Z	H3YN-41-Z

Note: Specify both the model number and supply voltage when ordering.

Example: H3YN-2 24 VAC

Supply voltage

MODEL NUMBER LEGEND:

H3YN - -
 1 2 3

1. Output
2: DPDT
4: 4PDT

2. Time Range
None: Short-time range (0.1 s to 10 min)
1: Long-time range (0.1 min to 10 hrs)

3. Contact Type
None: Single contact
Z: Twin contact

ACCESSORIES (ORDER SEPARATELY)

Connecting Socket

Applicable Timer	Track-mounting/front-connecting socket	Back-connecting socket		
		Solder terminal	Wire-wrap terminal	PCB terminal
H3YN-2/-21	PYF08A-E, PYF08A-N	PY08	PY08QN(2)	PY08-02
H3YN-4/-41 H3YN-4-Z/-41-Z	PYF14A-E, PYF14A-N	PY14	PY14QN(2)	PY14-02

Hold-Down Clips

Applicable socket	Part number
PYF08A-E, PYF08A-N, PYF14A-E, PYF14A-N	Y92H-3
PY08, PY08QN(2), PY08-02, PY14, PY14QN(2), PY14-02	Y92H-4

Panel Adapter

Applicable timer	Part number
H3YN-2/21, H3YN-4/41, H3YN-4-Z/41-Z	Y92F-78

Specifications

■ RATINGS

Item	H3YN-2/-4/-4-Z	H3YN-21/-41/-41-Z
Time ranges	0.1 s to 10 min (1 s, 10 s, 1 min, or 10 min max. selectable)	0.1 min to 10 h (1 min, 10 min, 1 h, or 10 h max. selectable)
Supply voltage	24, 100 to 120, 200 to 230 VAC; 12, 24, 48, 100 to 110, 125 VDC (see note 1)	
Operating mode	ON-delay, interval, repeat cycle with ON-start or OFF-start (selectable with DIP switch)	
Operating voltage	85% to 110% of rated supply voltage (12 VDC: 90% to 110% of rated supply voltage) (see note 2)	
Power consumption	24 VAC: Relay ON: 1.1 VA (at 24 VAC, 60 Hz) Relay OFF: 0.2 VA (at 24 VAC, 60 Hz) 100 to 120 VAC: Relay ON: 14 VA (at 120 VAC, 60 Hz) Relay OFF: 0.6 VA (at 120 VAC, 60 Hz) 200 to 230 VAC: Relay ON: 1.5 VA (at 230 VAC, 60 Hz) Relay OFF: 0.9 VA (at 230 VAC, 60 Hz) 12 VDC: Relay ON: 0.9 W (at 12 VDC) Relay OFF: 0.07 W (at 12 VDC) 24 VDC: Relay ON: 0.9 W (at 24 VDC) Relay OFF: 0.7 W (at 24 VDC) 48 VDC: Relay ON: 1.0 W (at 48 VDC) Relay OFF: 0.2 W (at 48 VDC) 100 to 110 VDC: Relay ON: 1.3 W (at 110 VDC) Relay OFF: 0.3 W (at 110 VDC) 125 VDC: Relay ON: 1.3 W (at 125 VDC) Relay OFF: 0.3 W (at 125 VDC)	
Control outputs	DPDT: 5 A at 250 VAC, resistive load ($\cos\phi = 1$) 4PDT: 3 A at 250 VAC, resistive load ($\cos\phi = 1$)	

- Note:**
1. Single-phase, full-wave-rectified power supplies can be used.
 2. When using the H3YN in any place where the ambient temperature is more than 50°C, supply 90% to 110% of the rated supply voltages (supply 95% to 110% with 12 VDC type).

■ CHARACTERISTICS

Item	H3YN-2/-21	H3YN-4/-41
Repeat accuracy	±1% FS max. (1 s range: ±1%±10 ms max.)	
Setting error	±10%±50 ms FS max.	
Resetting time	Min. power-opening time: 0.1 s max. (including halfway reset)	
Insulation resistance	100 MΩ min. (at 500 VDC)	
Dielectric strength	2,000 VAC, 50/60 Hz for 1 min (between current-carrying terminals and exposed non-current-carrying metal parts)	
	2,000 VAC, 50/60 Hz for 1 min (between operating circuit and control output)	
	1,000 VAC, 50/60 Hz for 1 min (between non-continuous contacts)	
	2,000 VAC, 50/60 Hz for 1 min (between contacts of different poles)	2,000 VAC, 50/60 Hz for 1 min (between contacts of different poles)
Vibration	Mechanical durability	10 to 55 Hz, 0.75-mm single amplitude
	Malfunction durability	10 to 55 Hz, 0.5-mm single amplitude
Shock	Mechanical durability	1,000 m/s ² (approx. 100G)
	Malfunction durability	100 m/s ² (approx. 10G)
Ambient temperature	Operating	-10°C to 50°C (14°F to 122°F) with no icing
	Storage	-25°C to 65°C (-13°F to 149°F) with no icing
Ambient humidity	Operating	35% to 85% RH
Service life	Mechanical	10,000,000 operations min. (under no load at 1,800 operations/h)
	Electrical	DPDT: 500,000 operations min. (5 A at 250 VAC, resistive load at 1,800 operations/h) 4PDT: 200,000 operations min. (H3YN-4-Z/-41-Z: 100,000 operations min.) (3 A at 250 VAC, resistive load at 1,800 operations/h)
Weight	Approx. 50 g	
Approvals	UL/CSA/CE (EMC) (LV)	

Engineering Data

■ ELECTRICAL SERVICE LIFE

Electrical Life Expectancy (Reference Value) H3YN-2/-21

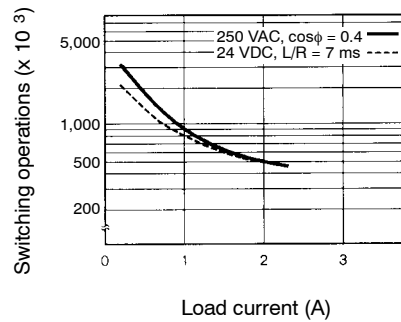
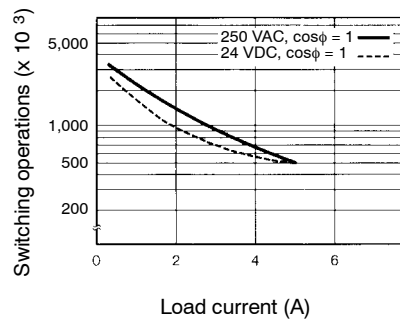

Reference: A maximum current of 0.6 A can be switched at 125 VDC (cosφ = 1).
Maximum current of 0.2 A can be switched if L/R is 7 ms. In both cases,
a life of 100,000 operations can be expected.
The minimum applicable load is 1 mA at 5 VDC (P reference value).

H3YN-4/-41

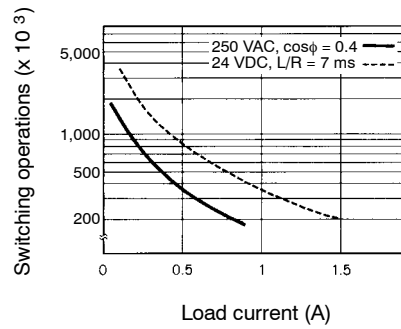
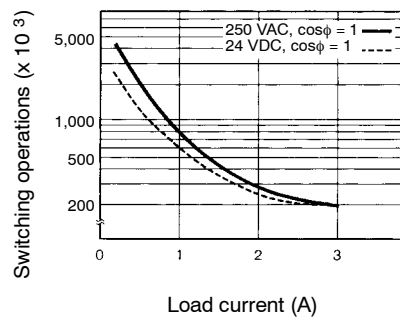

Reference: A maximum current of 0.5 A can be switched at 125 VDC (cosφ = 1).
Maximum current of 0.2 A can be switched if L/R is 7 ms. In both cases,
a life of 100,000 operations can be expected.
The minimum applicable load is 1 mA at 1 VDC (P reference value).

H3YN-4-Z/-41-Z

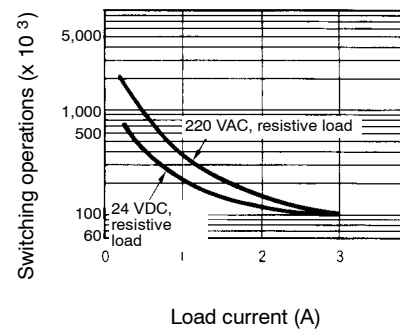

Reference: A maximum current of 0.5 A can be switched at 125 VDC (cosφ = 1).
Maximum current of 0.2 A can be switched if L/R is 7 ms. In both cases,
a life of 100,000 operations can be expected.
The minimum applicable load is 0.1 mA at 1 VDC (P reference value).

Nomenclature

Output Indicator (Orange)
(Lit: Output ON)

Main Dial
Set the desired time according to time range selectable by DIP switch.

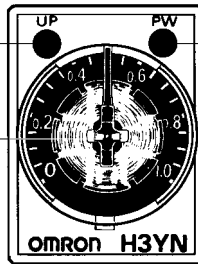

Run/Power Indicator (Green)
(Lit: Power ON)

Timing Charts

Operating mode	Timing chart	
	H3YN-2/-21	H3YN-4/-41
ON-delay 		
Interval 		
Repeat cycle OFF-start 		
Repeat cycle ON-start 		

Note: t: Set time
Rt: Reset time

■ PULSE OPERATION

A pulse output for a certain period can be obtained with a random external input signal.
Use the H3YN in interval mode as shown in the following timing charts.

H3YN-2/-21

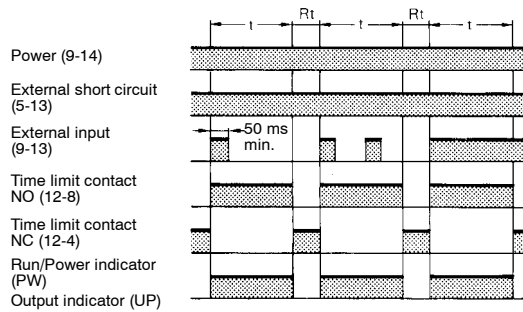
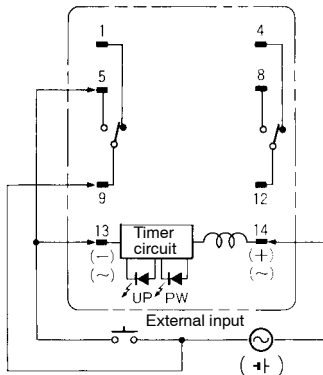

Note: t: Set time
Rt: Reset time

**H3YN-4/-41
H3YN-4-Z/-41-Z**

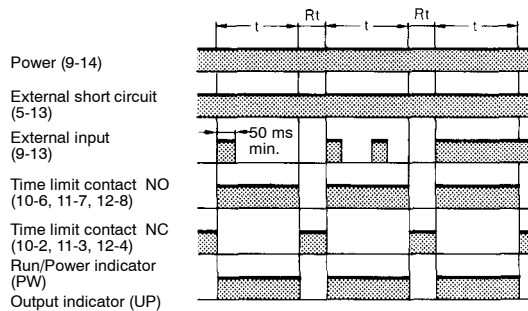
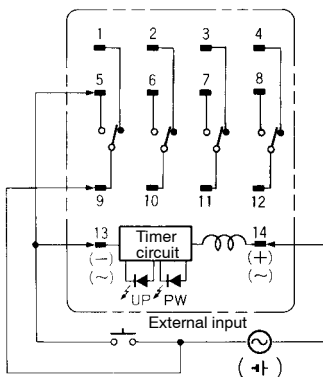

Note: t: Set time
Rt: Reset time

⚠ Caution

Be careful when connecting wires.

Mode	Terminals
Pulse operation	Power supply between 9 and 14 Short-circuit between 5 and 13 Input signal between between 9 and 13

Operation

■ DIP SWITCH SETTINGS

The 1-s range and ON-delay mode for H3YN-2/-4/-4-Z, the 1-min range and ON-delay mode for H3YN-21/-41/-41-Z are factory-set before shipping.

Time Ranges

Model	Time range	Time setting range	Setting	Factory-set
H3YN-2, H3YN-4 H3YN-4-Z	1 s	0.1 to 1 s		Yes
	10 s	1 to 10 s		No
	1 min	0.1 to 1 min		No
	10 min	1 to 10 min		No
H3YN-21, H3YN-41 H3YN-41-Z	1 min	0.1 to 1 min		Yes
	10 min	1 to 10 min		No
	1 h	0.1 to 1 h		No
	10 h	1 to 10 h		No

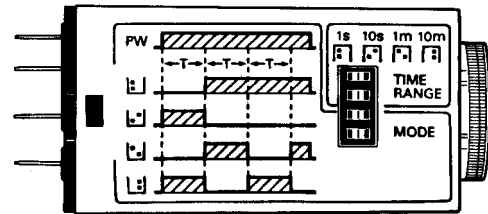

Note: The top two DIP switch pins are used to select the time ranges.

Operating Modes

Operating mode	Setting	Factory-set
ON-delay		Yes
Interval		No
Repeat cycle OFF-start		No
Repeat cycle ON-start		No

Note: The bottom two DIP switch pins are used to select the operating mode.

Connections

Part number	Power supply terminal numbers		Output terminal numbers			
	AC (common), DC-	AC (hot), DC+	Type	COM	NC	NO
H3YN-21-21	13	14	Timed contacts (DPDT)	9	1	5
H3YN-4/-41 H3YN 4-Z/41-Z	13	14	Timed contacts (4PDT)	9 10 11 12	1 2 3 4	5 6 7 8

Dimensions

Unit: mm (inch)

TIMERS

H3YN-2/-21

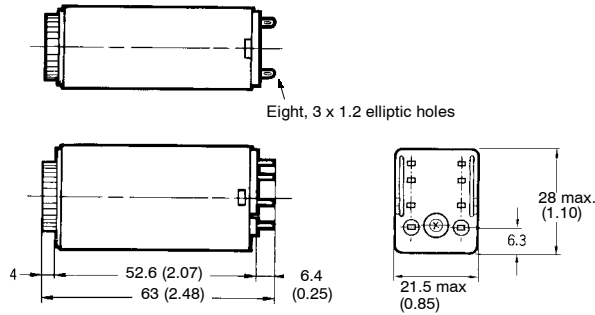

H3YN-4/-41 H3YN-4-Z/-41-Z

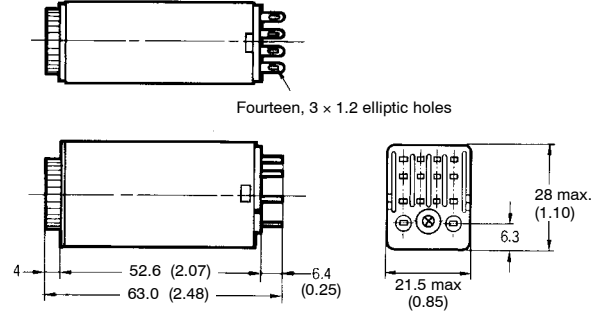

Overall Mounting Depth

PYF08E/PYF08A-N (PYF14A/PYF14-N see note)

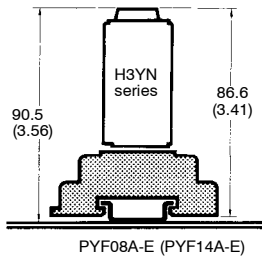

PY08 (PY14 see note)

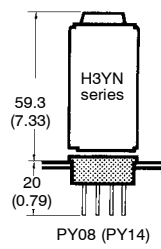

PY08QN (PY14QN see note)

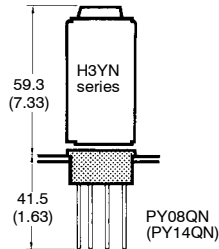

Note: Models in parentheses are sockets connecting to the H3YN-4/-4-Z.

SOCKETS

Track-Mounting/Front-Connecting Sockets
PYF08A-E

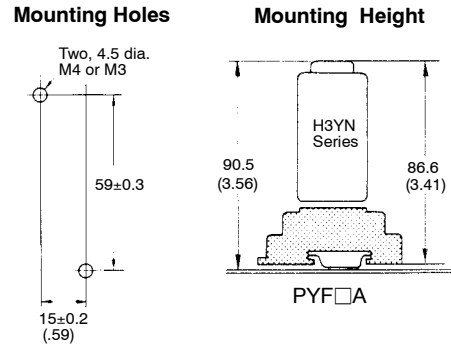
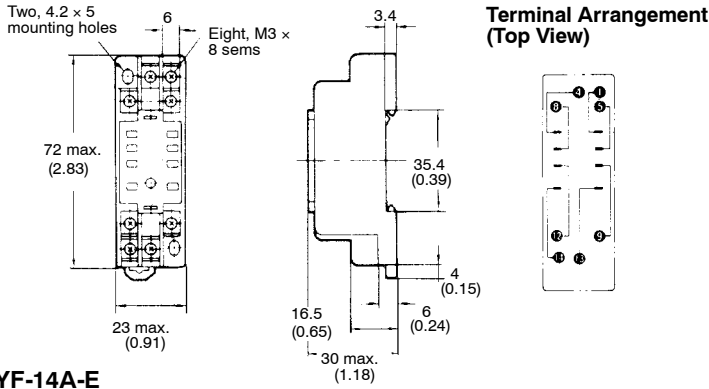

PYF-14A-E

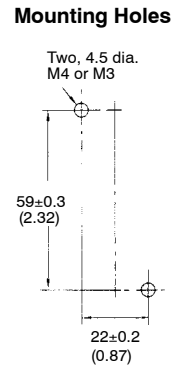
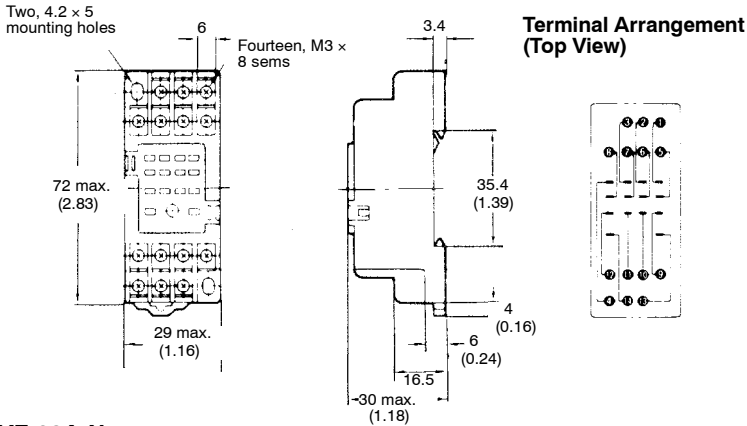

PYF-08A-N

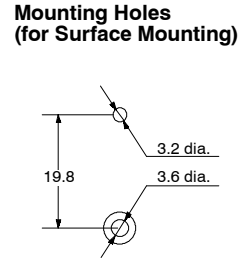
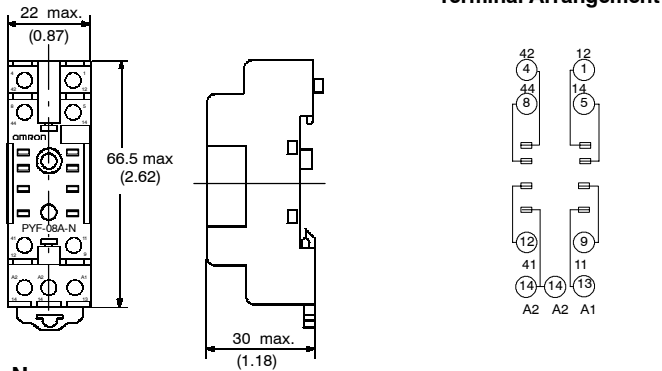

PYF-14A-N

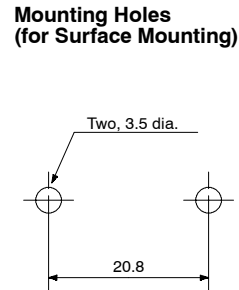
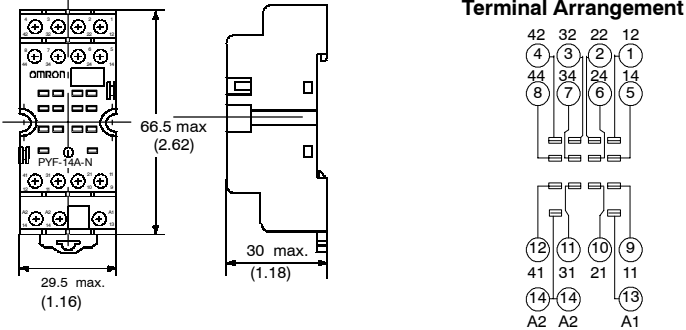

**Back-Connecting Sockets
PY08, PY14**

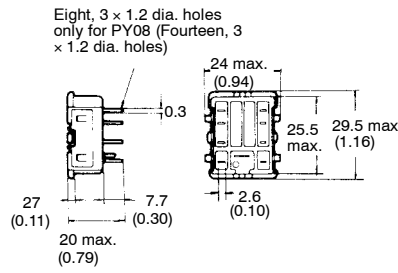

**Terminal Arrangement
(Bottom View)**

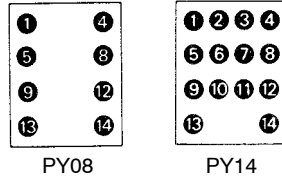

Panel Cutout

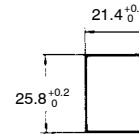

Mounting Height

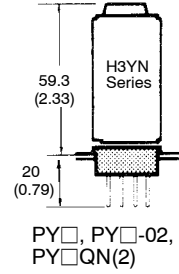

**PY08QN, PY14QN
PY08QN(2), PY14QN(2)**

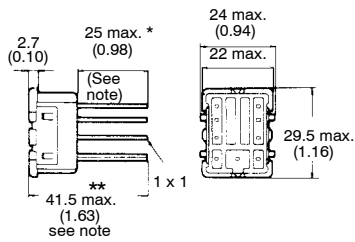

**Terminal Arrangement
(Bottom View)**

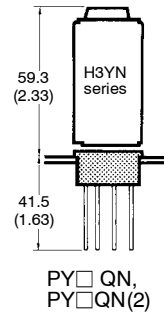
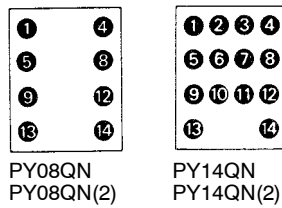

Note: With PY□QN(2)(-3), dimension * should read 20 max. (0.79) and dimension ** 36.5 max. (1.44)

PY08-02, PY14-02

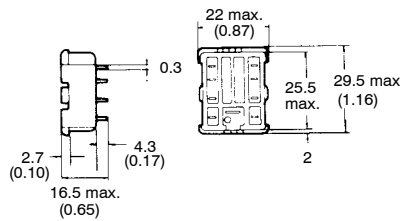

**Terminal Arrangement
(Bottom View)**

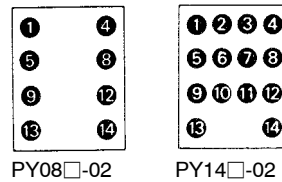

Hold-Down Clips

The hold-down clip makes it possible to mount the H3YN securely and prevent the H3YN from falling out due to vibration or shock.

Y92H-3
Y92H-4

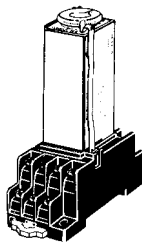

Y92H-3 for
PYF□A Socket

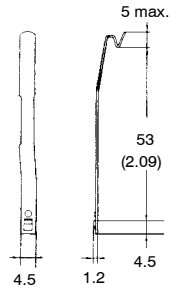

Y92H-4 for
PY□ Socket

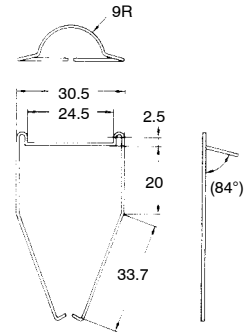

■ PANEL MOUNT ADAPTER Y92F-78

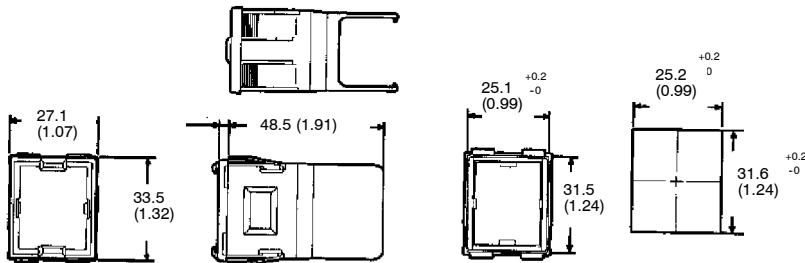

■ MOUNTING TRACK AND ACCESSORIES

PFP-100N, PFP-50N

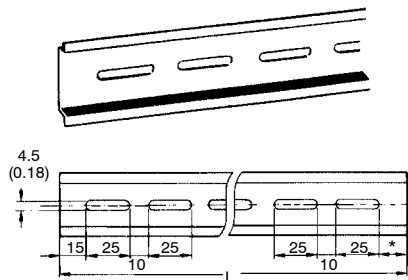

PFP-100N2

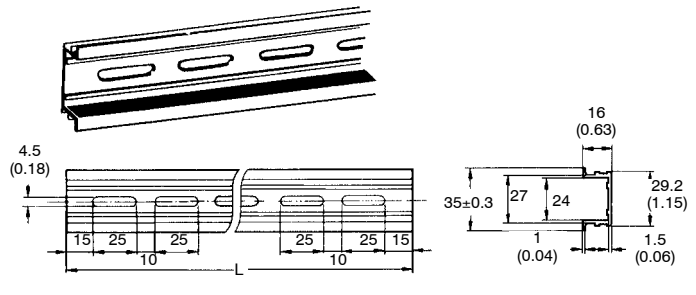

L: Length

1 m	PFP-100N
50 cm	PFP-50N
1 m	PFP-100N2

End Plate
PFP-M

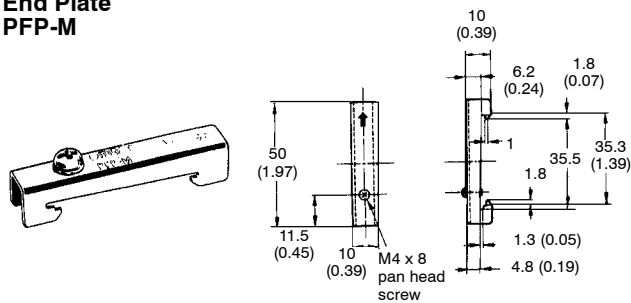

Spacer
PFP-S

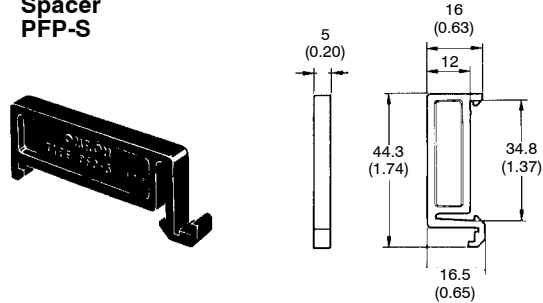

Precautions

■ CORRECT USE

When using the H3YN in any place where the ambient temperature is more than 50°C, supply 90% to 110% of the rated voltages (at 12 VDC: 95% to 110%).

Do not leave the H3YN in time-up condition for a long period of time (for example, more than one month in any place where the ambient temperature is high), otherwise the internal parts may become damaged. Therefore, the use of the H3YN with a relay as shown in the following circuit diagram is recommended.

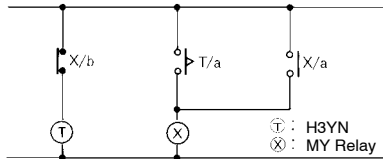

The H3YN must be disconnected from the socket when setting the DIP switch, otherwise the user may touch a terminal imposed with a high voltage and get an electric shock.

Do not connect the H3YN as shown in the following circuit diagram on the right hand side, otherwise the H3YN's internal contacts different from each other in polarity may become short-circuited.

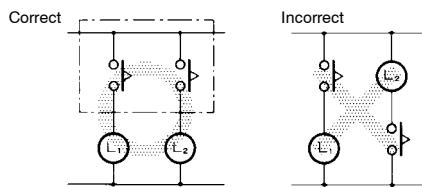

Use the following safety circuit when building a self-holding circuit with the H3YN and an auxiliary relay, such as an MY Relay, in combination.

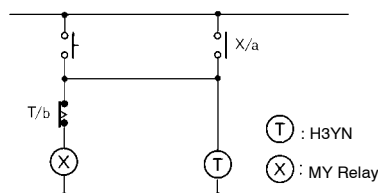

In the case of the above circuit, the H3YN will be in pulse operation.

Do not set to the minimum setting in the repeat-cycle modes, or the contact may become damaged.

Be careful not to apply any voltage to the terminal screws on the back of the timer. Mount the product so that the screws will not come in contact with the panel or metal parts.

Do not use the H3YN in places where there is excessive dust, corrosive gas, or direct sunlight.

Do not mount more than one H3YN closely together, otherwise the internal parts may become damaged. Make sure that there is a space of 5 mm or more between any adjacent H3YN Models.

The internal parts may become damaged if a supply voltage other than the rated ones is imposed on the H3YN.

■ PRECAUTIONS FOR VDE CONFORMANCE

The H3YN as a built-in timer conforms to VDE 0435/P2021 provided that the following conditions are satisfied.

Handling

Do not touch the DIP switch while power is supplied to the H3YN.

Before dismantling the H3YN from the socket, make sure that no voltage is imposed on any terminal of the H3YN.

Wiring

The power supply for the H3YN must be protected with equipment such as a breaker approved by VDE.

Only a load with basic isolation can be connected to the output contact. The H3YN is a model with basic isolation. Therefore, the H3YN and the load will ensure reinforced isolation, thus meeting VDE standards.

Insulation requirement: Overvoltage category II, pollution degree 2 (with a clearance of 1.5 mm and a creepage distance of 2.5 mm at 240 VAC)

There must be no difference in polarity between any output terminals next to each other of the H3YN-4 or H3YN-41, H3YN-4Z, H3YN-41-Z.

NOTE: DIMENSIONS SHOWN ARE IN MILLIMETERS. To convert millimeters to inches divide by 25.4.

OMRON[®]
OMRON ELECTRONICS LLC
 One East Commerce Drive
 Schaumburg, IL 60173
1-800-55-OMRON

OMRON ON-LINE
 Global - <http://www.omron.com>
 USA - <http://www.omron.com/oei>
 Canada - <http://www.omron.com/oci>

OMRON CANADA, INC.
 885 Milner Avenue
 Scarborough, Ontario M1B 5V8
416-286-6465