

RTC3 click™

2. Soldering the headers

Before using your click™ board, make sure to solder 1x8 male headers to both left and right side of the board. Two 1x8 male headers are included with the board in the package.

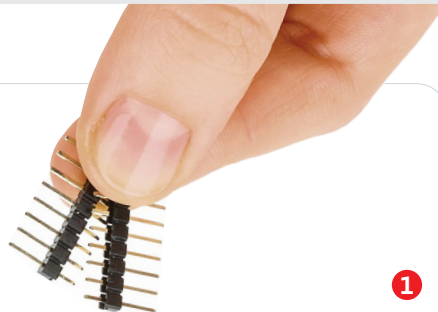

1



Turn the board upside down so that the bottom side is facing you upwards. Place shorter pins of the header into the appropriate soldering pads.

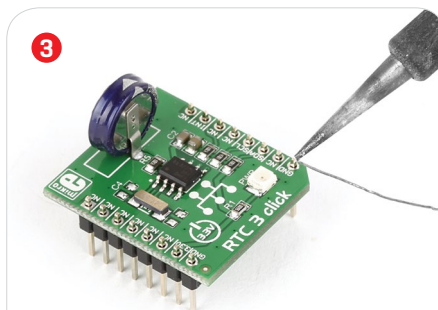

Turn the board upward again. Make sure to align the headers so that they are perpendicular to the board, then solder the pins carefully.

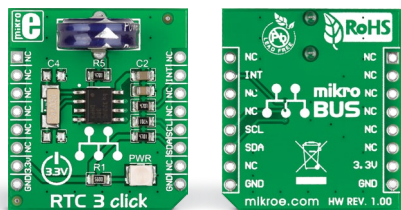

1. Introduction

RTC3 click™ carries **BQ32000**, a real time clock/calendar with automatic switchover to backup power supply. The clock frequency is derived from an onboard **32.768KHz oscillator**. RTC3 click™ communicates with the target board microcontroller through mikroBUS™ I2C lines: SCL, SDA. In addition, the INT pin serves as a configurable interrupt output. The board is designed to use a 3.3V power supply only.

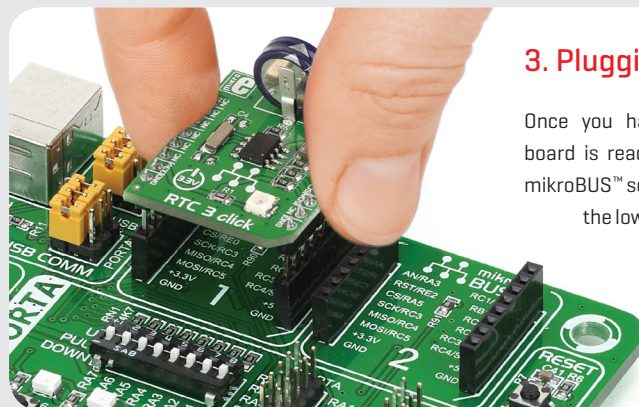

3. Plugging the board in

Once you have soldered the headers your board is ready to be placed into the desired mikroBUS™ socket. Make sure to align the cut in the lower-right part of the board with the markings on the silkscreen at the mikroBUS™ socket. If all the pins are aligned correctly, push the board all the way into the socket.

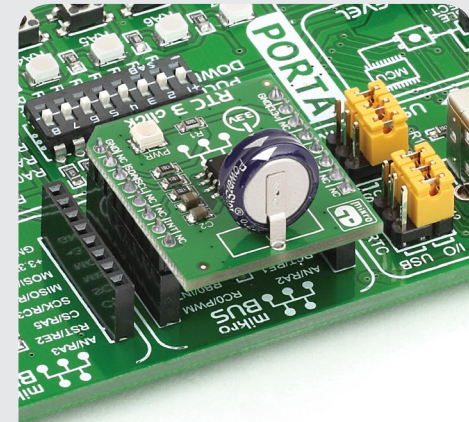

4. Essential features

RTC3 click™ has an integrated trickle charger that maintains a backup charge through with an onboard super capacitor. The board is ideal for applications which require real-time clocks, calendars and programmed alarms. It counts seconds, minutes, hours, date of the month, month, day of the week, and year with leap-year clock function with four year calendar.

click™
BOARD
www.mikroe.com



RTC3 click™ manual
ver 1.00



010000074497

5. Schematic

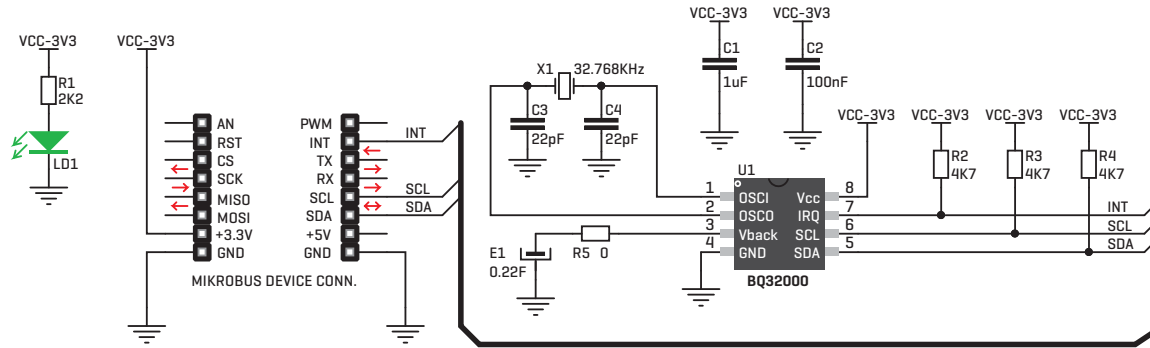

6. Dimensions

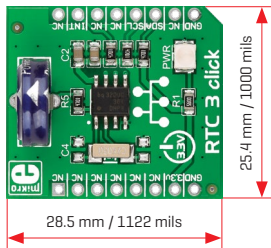

	mm	mils
LENGTH	28.5	1122
WIDTH	25.4	1000
HEIGHT*	16.4	645.7

* without headers

7. RTC3 click™ alternatives

RTC3 click™, as the name implies, is the third click™ board with a real time clock module. Visit the click™ board page to see all available alternatives. Including RTC click™ which can also work on a 5V power supply.

www.mikroe.com/click

8. Code examples

Once you have done all the necessary preparations, it's time to get your click™ board up and running. We have provided examples for mikroC™, mikroBasic™ and mikroPascal™ compilers on our **Libstock** website. Just download them and you are ready to start.



9. Support

MikroElektronika offers **free tech support** [www.mikroe.com/support] until the end of the product's lifetime, so if something goes wrong, we're ready and willing to help!



10. Disclaimer

MikroElektronika assumes no responsibility or liability for any errors or inaccuracies that may appear in the present document. Specification and information contained in the present schematic are subject to change at any time without notice.

Copyright © 2015 MikroElektronika.
All rights reserved.