



MICRO SWITCH™ LS
General Purpose Limit Switches
LS Series



MICRO SWITCH™ LS

General Purpose Limit Switches

The Honeywell MICRO SWITCH™ Compact LS Limit Switch Series offers products that have a long record of successful performance in a diverse range of industrial applications. Under severe conditions, its durable and dependable design provides longevity, precision, and consistent repeatability over millions of operations.

The compact size and adjustable features propel the LS Series to flourish in a variety of settings under space constraint without sacrificing reliability. Its construction is oil-tight, water-tight and dust tight, and includes die-cast housing, heads and actuators. An assortment of heads and actuators provides a solution for a variety of applications.

What makes our switches better?

- Small size and universal mounting footprint may allow for use in constricted spaces
- IP67 and NEMA 1, 3, 4, 6 and 13 ratings available provide a dependable solution in most demanding environmental conditions
- Rugged die-cast metal construction with a wide variety of heads and actuators provides long life across numerous applications
- MICRO SWITCH™ legacy and expertise - over 55 years of engineering excellence and experience with industrial limit switches

***Rugged, metal housing
packaged for industrial indoor
and outdoor applications***



QUALITY, RELIABLE
RUGGED, GLOBAL

Features and Benefits

ENHANCED PERFORMANCE COMPACT DESIGN

Along with industry standard mounting dimensions, the LS Series compact design allows installation in applications under space constraint while still providing reliable switching performance

TWO CIRCUIT DOUBLE BREAK CONTACTS

With an AC15, A300 or 10 A electrical rating, the LS Series provides dependable and consistent switching, giving the end users control of two circuits in one switch

One switch controls two circuits!

ACTUATORS FOR YOUR APPLICATION

With many actuators available such as side rotary, plunger, wobble stick and roller plunger, the LS Series is adaptable and has the ability to be applied in a variety of applications

SEALED CONSTRUCTION

In demanding environmental conditions, IP67 or NEMA 1, 3, 4, 6, and 13 sealing protects against oil, dust and water making the LS Series a dependable solution in a variety of conditions for both indoor and outdoor applications

Potential Applications



MACHINE TOOL EQUIPMENT

Part presence, machine slide/table position, panel and door presence

MATERIAL HANDLING

Sensing in overhead doors, door interlock, dock locks, conveyance, storage retrieval, carousels, conveyors, and assembly lines

VALVE ACTUATION

Position sensing of electric valves for waste water treatment plants, power plants, refineries, and pipelines



FOOD AND BEVERAGE

Sensing during bottling, canning, and packaging

SPECIAL MACHINERY

Assembly, packaging and testing applications

LS Series

MICRO SWITCH™ LS SERIES PRODUCT NOMENCLATURE

Switch body							
Compact SPDT	SPDT Plug-in less base	Switch style	Product family	Actuator code	Actuator description	Modifications (may be applied to most configurations)	
1	201	side rotary (momentary) CW and CCW actuation. Field adjustable for CW and CCW	LS	1	standard with 38,1 mm fixed length lever with steel roller	(blank) 0.5-14 NPT conduit	
				19	low pretravel with 38,1 mm fixed length lever with steel roller		
				6	low operating torque with 38,1 mm fixed length lever with steel roller		
				131	low pretravel, low operating torque with 38,1 mm fixed length lever with steel roller		
				3	standard with adjustable length lever, 38 mm to 89 mm with nylon roller		
				10	standard with adjustable 127 mm aluminum rod		
				2	standard, no lever		
				9	low pretravel with no lever		
				23	low operating torque with no lever		
2	202	top pin plunger	LS	1	standard	-L UL/CSA certified with 0.5-14 NPT conduit	
	n/a	top pin plunger		111	plunger boot seal		
3	203	side roller plunger	LS	1	standard	-4C CE with 20 mm conduit	
4	204	side pin plunger	LS	1	standard		
5	205	top roller plunger	LS	1	standard	-4PG CE with PG 13,5 mm conduit	
	n/a	top roller plunger		8	plunger boot seal		
6	206	two position side rotary (maintained)	LS	1	standard with 38,1 mm fixed length fork lever with roller		
				2	no lever		
7	n/a	side rotary enclosure mount	LS	1	standard with 38,1 mm fixed length lever with steel roller		
8	208	wobble actuator	LS	1	steel coil spring, 141 mm		
	208	wobble actuator		3	aluminum rod, 141 mm		
	208	wobble actuator		125	cat whisker, 191 mm		
	208	wobble actuator		152	stainless steel coil spring, 141 mm		

Not all combinations are available. Please contact your Honeywell provider/representative for assistance.

MICRO SWITCH™ General Purpose Limit Switches

Table 1. Specifications

Characteristic	North America	EMEA (Europe)
Product type	Honeywell general purpose LS limit switch, compact and plug-in	Honeywell general purpose LS-4 limit switch, compact and plug-in
Acutators	side rotary, side rotary (maintained) top pin plunger, top roller plunger, wobble coil spring, wobble aluminum rod, wobble cat whisker, wobble sst coil spring	
Circuitry	single pole double throw (SPDT) double break,	single pole double throw (SPDT) double break
Electrical	10 A (see Table 2)	AC 15, A300; DC 13, P300
Housing material	compact: epoxy coated zinc die cast plug-in: epoxy coated aluminum die cast	epoxy coated aluminum die cast
Conduit	0.5 – 14 NPT	20 mm or PG13,5
Housing seal rating	NEMA 1,3,4, 6 and 13	IP67, NEMA 1,4 and 13
Operating temperature	standard: -29 °C to 71 °C [-20 °F to 160 °F] high temp.: -29 °C to 120 °C [-20 °F to 248 °F]	standard: -30 °C to 70 °C [-22 °F to 158 °F] high temp.: -30 °C to 120 °C [-22 °F to 248 °F]
Agency certifications	Compact with -L suffix UL file 12252, CSA file 57325	CE, EN60947-5-41, IEC60947-5-4

Table 2. Electrical Ratings

Electrical Code	Electrical Ratings					
A	10 A, 120, 240 or 480 Vac; 1/3 hp 120 Vac; 3/4 hp 240 Vac; 0.8 amp, 115 Vdc; 0.4 amp, 230 Vdc; 0.1 amp, 550 Vdc, Pilot Duty, 600 Vac max.					
B	10 A, 120, 240 or 480 Vac; 1/4 hp 120 Vac; 1/2 hp 240 Vac; Pilot Duty, 600 Vac max.					
C	10 A, 1/3 hp 120 Vac					
D	10 A, 120, 240 or 480 Vac; 1/4 hp 120 Vac; 1/2 hp 240 Vac; 0.8 amp, 115 Vdc; 0.4 amp, 230 Vdc; 0.1 amp, 550 Vdc, Pilot Duty, 600 Vac max.					
E	10 A, 120, 240 or 480 Vac; 1/3 hp 120 Vac; 3/4 hp 240 Vac; Pilot Duty, 600 Vac max.					
F	5 A, 6 V; 1 A, 24 V; 0.4 A, 220 V					
G	UL & CSA; 10 A, 125, 250 or 480 Vac; 1/3 hp 125 Vac; 3/4 hp 250 Vac; 0.8 amp, 115 Vdc; 0.4 amp, 230 Vdc					
H	UL & CSA; 10 A, 125, 250 or 480 Vac; 1/4 hp 125 Vac; 1/2 hp 250 Vac; 0.8 amp, 115 Vdc; 0.4 amp, 230 Vdc					
J	EN60947-5-1, IEC 60947-5-1					
	Designation & Category	Thermal Current, It(Amps)	Rated Operational Voltage, Ue	Rated Operational Amps, Ie	VA rating Make	VA rating Break
	ac					
	AC15, A300	10	120	6	7200	720
	AC15, A300	10	240	3	7200	720
	dc					
	DC13, P300	5	125	1.1	138	138
DC13, P300	5	250	0.55	138	138	

LS Series

MICRO SWITCH™ LS SERIES ORDER GUIDE/RECOMMENDED LISTINGS (FOR NORTH AMERICA)

For listings not shown, contact your Honeywell representative.

Table 3. Side Rotary (Momentary), Standard Roller Lever

	Compact, SPDT w 0.5-14 NPT conduit	Plug-in less base*	Description	Electrical Rating (Table 2)	
	1LS1	201LS1	side rotary w/ 38,1mm [1.5 in] fixed lever, steel roller	A	
	1LS1-L	–	side rotary w/ 38,1mm [1.5 in] fixed lever, steel roller	G	
	1LS2	–	side rotary, no lever	A	
	1LS2-L	–	side rotary, no lever	G	
	1LS243	201LS242	side rotary w/ 38,1mm [1.5 in] fixed lever, steel roller	A	
	1LS6	201LS6	side rotary w/ 38,1 mm [1.5 in] fixed lever, steel roller	A	
	1LS6-L	–	side rotary w/ 38,1 mm [1.5 in] fixed lever, steel roller	G	
	1LS23	201LS23	side rotary, no lever	A	
	1LS501	201LS501	side rotary w/ 38,1mm [1.5 in] fixed lever, steel roller	C	
	1LS19	201LS19	side rotary w/ 38,1mm [1.5 in] fixed lever, steel roller	B	
	1LS9	201SL9	side rotary, no lever	B	
	1LS131	–	side rotary w/ 38,1 mm [1.5 in] fixed lever, steel roller	B	
	1LS56	201LS56	side rotary, no lever	B	

¹Contact closed ■; Contact open □. *Requires an 18PA1 Terminal Block (base receptacle) which must be ordered separately. 18PA1 terminal block has 0.5-14 NPT conduit threads.

Table 4. Side Rotary (Maintained), Standard Fork Roller Lever

	Compact, SPDT w 0.5-14 NPT conduit	Plug-in less base*	Description	Electrical Rating (Table 2)	
	6LS1	206LS1	side rotary maintained w/ 38,1mm [1.5 in] fork lever, steel rollers, opposite side	A	
	6LS2	206LS2	side rotary maintained, no lever	A	
	6LS2-L	–	side rotary maintained, no lever	G	
	6LS3	–	side rotary maintained w/ 38,1mm [1.5 in] fork lever, nylon rollers, same side	A	

¹Contact closed ■; Contact open □. *Requires an 18PA1 Terminal Block (base receptacle) which must be ordered separately. 18PA1 terminal block has 0.5-14 NPT conduit threads.

MICRO SWITCH™ General Purpose Limit Switches

- O.T. • Operating torque
- O.F. • Operating force
- R.P. • Release point
- P.T. • Pretravel
- O.T. • Overtravel
- D.T. • Differential travel

Operating Torque or Force	Bar Chart ¹	Operate Point	Pretravel (max.)	Overtravel (min.)	Differential Travel (max.)	Notes
0,51 Nm [4.5 in-lb]		–	20°	30°	12°	–
0,51 Nm [4.5 in-lb]		–	20°	30°	12°	UL & CSA
0,51 Nm [4.5 in-lb]		–	20°	30°	12°	–
0,51 Nm [4.5 in-lb]		–	20°	30°	12°	UL & CSA
0,51 Nm [4.5 in-lb]		–	20°	30°	12°	high-temp. 120 °C [248 °F]
0,19 Nm [1.7 in-lb]		–	20°	30°	12°	low torque
0,19 Nm [1.7 in-lb]		–	20°	30°	12°	low torque, UL & CSA
0,19 Nm [1.7 in-lb]		–	20°	30°	12°	low torque
0,51 Nm [4.5 in-lb]		–	20°	30°	12°	indicator for 120 Vac only
0,51 Nm [4.5 in-lb]			–	5°	30°	4°
0,51 Nm [4.5 in-lb]	–		5°	30°	4°	low pretravel
0,19 Nm [1.7 in-lb]	–		5°	30°	4°	low pretravel and low torque
0,19 Nm [1.7 in-lb]	–		5°	30°	4°	low pretravel and low torque

Operating Torque or Force	Bar Chart ¹	Operate Point	Pretravel (max.)	Total travel (nom.)	Differential Travel (max.)	Notes
0,34 Nm [3 in-lb]		–	55°	90°	20°	
0,34 Nm [3 in-lb]		–	55°	90°	20°	
0,34 Nm [3 in-lb]		–	55°	90°	20°	UL & CSA
0,34 Nm [3 in-lb]		–	55°	90°	20°	

LS Series

MICRO SWITCH™ LS SERIES ORDER GUIDE/RECOMMENDED LISTINGS (FOR NORTH AMERICA)

For listings not shown, contact your Honeywell representative.

Table 5. Side Rotary, Adjustable Roller Lever



	Compact, SPDT w 0.5-14 NPT conduit	Plug-in less base*	Description	Electrical Rating (Table 2)
	1LS3	201LS3	side rotary w/ 38,1 mm to 88,9mm [1.5 in to 3.5 in] adjustable lever, nylon roller	A
	1LS3-L	–	side rotary w/ 38,1 mm to 88,9mm [1.5 in to 3.5 in] adjustable lever, nylon roller	G
	1LS58	–	side rotary w/ 38,1 mm to 88,9mm [1.5 in to 3.5 in] adjustable lever, nylon roller	B
	1LS59	–	side rotary w/ 38,1 mm to 88,9mm [1.5 in to 3.5 in] adjustable lever, nylon roller	B

¹Contact closed ■; Contact open □. *Requires an 18PA1 Terminal Block (base receptacle) which must be ordered separately. 18PA1 terminal block has 0.5-14 NPT conduit threads.

Table 6. Side Rotary, Adjustable Rod Lever



	Compact, SPDT w 0.5-14 NPT conduit	Plug-in less base*	Description	Electrical Rating (Table 2)
	1LS10	201LS10	side rotary w/ 140 mm [5.5 in] max. adjustable aluminum rod	A
	1LS10-L	–	side rotary w/ 140 mm [5.5 in] max. adjustable aluminum rod	G
	1LS47	201LS47	side rotary w/ 140 mm [5.5 in] max. adjustable aluminum rod	B
	1LS53	201LS51	side rotary w/ 140 mm [5.5 in] max. adjustable aluminum rod	B

¹Contact closed ■; Contact open □. *Requires an 18PA1 Terminal Block (base receptacle) which must be ordered separately. 18PA1 terminal block has 0.5-14 NPT conduit threads.

MICRO SWITCH™ General Purpose Limit Switches

- O.T. • Operating torque
- O.F. • Operating force
- R.P. • Release point
- P.T. • Pretravel
- O.T. • Overtravel
- D.T. • Differential travel

Operating Torque or Force	Bar Chart ¹	Operate Point	Pretravel (max.)	Overtravel (min.)	Differential Travel (max.)	Notes
0,51 Nm [4.5 in-lb]		-	20°	30°	12°	-
0,51 Nm [4.5 in-lb]		-	20°	30°	12°	UL & CSA
0,51 Nm [4.5 in-lb]		-	5°	30°	4°	low pretravel
0,19 Nm [1.7 in-lb]		-	5°	30°	4°	low pretravel and low torque

Operating Torque or Force	Bar Chart ¹	Operate Point	Pretravel (max.)	Overtravel (min.)	Differential Travel (max.)	Notes
0,19 Nm [1.7 in-lb]		-	20°	30°	12°	-
0,19 Nm [1.7 in-lb]		-	20°	30°	12°	UL & CSA
0,19 Nm [1.7 in-lb]		-	5°	30°	4°	low pretravel
0,11 Nm [1.0 in-lb]		-	5°	30°	4°	low pretravel and low torque

LS Series

MICRO SWITCH™ LS SERIES ORDER GUIDE/RECOMMENDED LISTINGS (FOR NORTH AMERICA)

For listings not shown, contact your Honeywell representative.

Table 7. Top Pin Plunger

	Compact, SPDT w 0.5-14 NPT conduit	Plug-in less base*	Description	Electrical Rating (Table 2)	Operating Torque or Force
	2LS1	202LS1	Top pin plunger (hardened SST)	A	31,1 N [7.0 lb]
	2LS1-L	-	Top pin plunger (hardened SST)	G	31,1 N [7.0 lb]
	2LS111	202LS111	Top pin plunger (hardened SST) with boot seal	E	10,0 N [2.2 lb]

¹Contact closed ■; Contact open □. NOTE: Bar chart measurements are in millimeters.

*Requires an 18PA1 Terminal Block (base receptacle) which must be ordered separately. 18PA1 terminal block has 0.5-14 NPT conduit threads.

Table 8. Top Roller Plunger

	Compact, SPDT w 0.5-14 NPT conduit	Plug-in less base*	Description	Electrical Rating (Table 2)	Operating Torque or Force
	5LS1	205LS1	Top roller plunger (hardened steel roller)	A	31,1 N [7.0 lb]
	5LS1-L	-	Top roller plunger (hardened steel roller)	G	31,1 N [7.0 lb]
	5LS8	-	Top roller plunger (hardened steel roller) with boot seal		15,57 N [3.5 lb]

¹Contact closed ■; Contact open □. NOTE: Bar chart measurements are in millimeters.

*Requires an 18PA1 Terminal Block (base receptacle) which must be ordered separately. 18PA1 terminal block has 0.5-14 NPT conduit threads.

Table 9. Side Pin Plunger

	Compact, SPDT w 0.5-14 NPT conduit	Plug-in less base*	Description	Electrical Rating (Table 2)	Operating Torque or Force
	4LS1	204LS1	Side pin plunger (SST)	A	40,0 N [9.0 lb]

¹Contact closed ■; Contact open □. NOTE: Bar chart measurements are in millimeters.

*Requires an 18PA1 Terminal Block (base receptacle) which must be ordered separately. 18PA1 terminal block has 0.5-14 NPT conduit threads.

Table 10. Side Roller Plunger

	Compact, SPDT w 0.5-14 NPT conduit	Plug-in less base*	Description	Electrical Rating (Table 2)	Operating Torque or Force
	3LS1	203LS1	Side roller plunger (hardened steel roller)	A	40,0 N [9.0 lb]

MICRO SWITCH™ General Purpose Limit Switches

- O.T. • Operating torque
- O.F. • Operating force
- R.P. • Release point
- P.T. • Pretravel
- O.T. • Overtravel
- D.T. • Differential travel

Bar Chart ¹	Free Position (nom.)	Operate Point	Pretravel (max.)	Overtravel (min.)	Differential Travel (max.)	Notes
	35,5 mm [1.40 in]	33,78 mm ±0,78 mm [1.33 in ±0.03 in]	1,65 mm [0.065 in]	6,35 mm [0.25 in]	0,51 mm [0.02 in]	-
	35,5 mm [1.40 in]	33,78 mm ±0,78 mm [1.33 in ±0.03 in]	1,65 mm [0.065 in]	6,35 mm [0.25 in]	0,51 mm [0.02 in]	UL & CSA
	35,5 mm [1.40 in]	33,78 mm ±0,78 mm [1.33 in ±0.03 in]	1,65 mm [0.065 in]	5,6 mm [0.22 in]	0,23 mm [0.009 in]	lower operating force

Bar Chart ¹	Free Position (nom.)	Operate Point	Pretravel (max.)	Overtravel (min.)	Differential Travel (max.)	Notes
	45,6 mm [1.80 in]	43,95 mm ±0,78 mm [1.73 in ±0.03 in]	1,65 mm [0.065 in]	5,6 mm [0.22 in]	0,51 mm [0.02 in]	-
	45,6 mm [1.80 in]	43,95 mm ±0,78 mm [1.73 in ±0.03 in]	1,65 mm [0.065 in]	5,6 mm [0.22 in]	0,51 mm [0.02 in]	UL & CSA
	45,6 mm [1.80 in]	43,95 mm ±0,78 mm [1.73 in ±0.03 in]	1,65 mm [0.065 in]	5,6 mm [0.22 in]	0,51 mm [0.02 in]	lower operating force

Bar Chart ¹	Free Position (nom.)	Operate Point	Pretravel (max.)	Overtravel (min.)	Differential Travel (max.)	Notes
	56,4 mm [2.22 in]	54,10 mm ±0,78 mm [2.13 in ±0.03 in]	2,77 mm [0.11 in]	6,35 mm [0.25 in]	1,02 mm [0.04 in]	-

Bar Chart ¹	Free Position (nom.)	Operate Point	Pretravel (max.)	Overtravel (min.)	Differential Travel (max.)	Notes
	70,35 mm [2.77 in]	67,56 mm ±0,78 mm [2.66 in ±0.03 in]	2,79 mm [0.11 in]	6,35 mm [0.25 in]	1,02 mm [0.04 in]	Roller plunger may be locked in any position through 360°

LS Series

MICRO SWITCH™ LS SERIES ORDER GUIDE/RECOMMENDED LISTINGS (FOR NORTH AMERICA)

For listings not shown, contact your Honeywell representative.

¹Contact closed ■; Contact open □. NOTE: Bar chart measurements are in millimeters.

*Requires an 18PA1 Terminal Block (base receptacle) which must be ordered separately. 18PA1 terminal block has 0.5-14 NPT conduit threads.

Table 11. Side Rotary with Face Plate

	Compact, SPDT w 0.5-14 NPT conduit	Plug-in less base	Description	Electrical Rating (Table 2)
	7LS1	-	Face plate with 1LS1 for enclosure installation with 38,1 mm [1.5 in] fixed lever, steel roller	A

¹Contact closed ■; Contact open □.

Table 12. Wobble, Coil Spring

	Compact, SPDT w 0.5-14 NPT conduit	Plug-in less base*	Description	Electrical Rating (Table 2)
	8LS1	208LS1	Wobble actuated, random motion 141 mm [5.55 in] tin plated, coil spring steel	D
	8LS1-L	-	Wobble actuated, random motion 141 mm [5.55 in] tin plated, coil spring steel	H
	8LS3	208LS3	Wobble actuated, random motion 141 mm [5.55 in] aluminum rod	D
	8LS125	208LS125	Wobble actuated, random motion 191 mm [7.53 in] stainless steel cat whisker	D
	8LS152	208LS152	Wobble actuated, random motion 141 mm [5.55 in] stainless steel coil spring	D

¹Contact closed ■; Contact open □. NOTE: Bar chart measurements are in millimeters.

*Requires an 18PA1 Terminal Block (base receptacle) which must be ordered separately. 18PA1 terminal block has 0.5-14 NPT conduit threads.

² Operating position in any direction except pull.

MICRO SWITCH™ General Purpose Limit Switches

- O.T. • Operating torque
- O.F. • Operating force
- R.P. • Release point
- P.T. • Pretravel
- O.T. • Overtravel
- D.T. • Differential travel

Operating Torque or Force	Bar Chart ¹	Operate Point	Pretravel (max.)	Overtravel (min.)	Differential Travel (max.)	Notes
0,51 Nm [4.5 in-lb]		–	20°	30°	12°	–

Operating Torque or Force	Bar Chart ¹	Operate Point ² (max.)	Pretravel (max.)	Overtravel (nom.)	Differential Travel (max.)	Notes
1,39 N [5.0 oz]		28,6 mm [1.125 in]	28,6 mm [1.125 in]	30,7 mm [1.21 in]	–	–
1,39 N [5.0 oz]		28,6 mm [1.125 in]	28,6 mm [1.125 in]	30,7 mm [1.21 in]	–	UL & CSA
1,39 N [5.0 oz]		28,6 mm [1.125 in]	28,6 mm [1.125 in]	30,7 mm [1.21 in]	–	–
0,28 N [1.0 oz]		63,5 mm [2.5 in]	63,5 mm [2.5 in]	63,5 mm [2.5 in]	–	–
1,39 N [5.0 oz]		28,6 mm [1.125 in]	28,6 mm [1.125 in]	30,7 mm [1.21 in]	–	–

LS Series

MICRO SWITCH™ LS SERIES ORDER GUIDE/RECOMMENDED LISTINGS (FOR EMEA/EUROPE)

For listings not shown, contact your Honeywell representative.

Table 13. Side Rotary (Momentary), Standard Roller Lever

	Compact 20 mm conduit	Compact PG 13,5 conduit	Plug-in less base*	Description	Electrical Rating (Table 2)
	1LS1-4C	1LS1-4PG	201LS1-4	Side rotary, with 38,1 mm [1.5 in] fixed lever, steel roller	J
	1LS2-4C	1LS2-4PG	201LS2-4	Side rotary, no lever	J
	1LS243-4C	1LS243-4PG	–	Side rotary, with 38,1 mm [1.5 in] fixed lever, steel roller	J
	1LS244-4C	1LS244-4PG	–	Side rotary, with 38,1 mm [1.5 in] fixed lever, steel roller	J
	1LS19-4C	1LS19-4PG	201LS1-4	Side rotary, with 38,1 mm [1.5 in] fixed lever, steel roller	J
	1LS56-4C	1LS56-4PG	201LS56-4	Side rotary, lever	J

*Contact closed ■; Contact open □. * Requires an 18PA1-4C Terminal Block (20 mm conduit threads) or 18PA1-4PG Terminal Block (PG13,5 conduit threads) ordered separately. Terminal block is base receptacle.

Table 14. Side Rotary (Maintained), Fork Roller Lever

	Compact 20 mm conduit	Compact PG 13,5 conduit	Plug-in less base*	Description	Electrical Rating (Table 2)
	6LS1-4C	6LS1-4PG	206LS1-4	Side rotary maintained with 38,1 mm fork lever with steel rollers, opp. side	J
	6LS3-4C	6LS3-4PG	–	Side rotary maintained with 38,1 mm fork lever with nylon rollers, same side	J
	6LS2-4C	6LS2-4PG	–	Side rotary maintained, no lever	J

*Contact closed ■; Contact open □. * Requires an 18PA1-4C Terminal Block (20 mm conduit threads) or 18PA1-4PG Terminal Block (PG13,5 conduit threads) ordered separately. Terminal block is base receptacle.

Table 15. Side Rotary, Adjustable Roller Lever

	Compact 20 mm conduit	Compact PG 13,5 conduit	Plug-in less base*	Description	Electrical Rating (Table 2)
	1LS3-4C	1LS3-4PG	201LS3-4	Side rotary, with 25 mm to 89 mm [1.0 in to 3.5 in] adjustable lever, nylon roller	J

*Contact closed ■; Contact open □. * Requires an 18PA1-4C Terminal Block (20 mm conduit threads) or 18PA1-4PG Terminal Block (PG13,5 conduit threads) ordered separately. Terminal block is base receptacle.

MICRO SWITCH™ General Purpose Limit Switches

- O.T. • Operating torque
- O.F. • Operating force
- R.P. • Release point
- P.T. • Pretravel
- O.T. • Overtravel
- D.T. • Differential travel

Operating Torque or Force	Bar Chart ¹	Operate Point	Pretravel (max.)	Overtravel (min.)	Differential Travel (max.)	Notes
0,51 Nm [4.5 in-lb]		–	20°	30°	12°	–
0,51 Nm [4.5 in-lb]		–	20°	30°	12°	–
0,51 Nm [4.5 in-lb]		–	20°	30°	12°	High temp. 120 °C [248 °F]
0,51 Nm [4.5 in-lb]		–	20°	30°	12°	High temp. 120 °C [248 °F], fluorcarbon o-rings
0,51 Nm [4.5 in-lb]		–	5°	30°	4°	Low pretravel
0,19 Nm [1.7 in-lb]		–	5°	30°	4°	Low pretravel & low torque

Operating Torque or Force	Bar Chart ¹	Operate Point	Pretravel (max.)	Total Travel (nom.)	Differential Travel (max.)	Notes
0,33 Nm [3.01 in-lb]		–	55°	90°	20°	–
0,33 Nm [3.01 in-lb]		–	55°	90°	20°	–
0,33 Nm [3.01 in-lb]		–	55°	90°	20°	–

Operating Torque or Force	Bar Chart ¹	Operate Point	Pretravel (max.)	Overtravel (min.)	Differential Travel (max.)	Notes
0,51 Nm [4.5 in-lb]		–	20°	30°	12°	–

LS Series

MICRO SWITCH™ LS SERIES ORDER GUIDE/RECOMMENDED LISTINGS (FOR EMEA/EUROPE)

For listings not shown, contact your Honeywell representative.

Table 16. Side Rotary, Adjustable Rod Lever

	Compact 20 mm conduit	Compact PG 13,5 conduit	Plug-in less base*	Description	Electrical Rating (Table 2)
	1LS10-4C	1LS10-4PG	201LS10-4	Side rotary with 140 mm [5.5 in] max. adjustable aluminum rod	J
	1LS47-4PG	-	-	Side rotary with 140 mm [5.5 in] max. adjustable aluminum rod	J

1 Contact closed ■; Contact open □. * Requires an 18PA1-4C Terminal Block (20 mm conduit threads) or 18PA1-4PG Terminal Block (PG13,5 conduit threads) ordered separately. Terminal block is base receptacle.

Table 17. Top Pin Plunger

	Compact 20 mm conduit	Compact PG 13,5 conduit	Plug-in less base*	Description	Electrical Rating (Table 2)	Operating Torque or Force
	2LS1-4C	2LS1-4PG	202LS1-4	Top pin plunger (SST)	J	31,4 N [7.06 lb]
	-	2LS1-4GPG	-	Top pin plunger (SST)	F	31,4 N [7.06 lb]
	2LS1-4CN151	-	-	Top pin plunger (SST)	J	31,4 N [7.06 lb]

1 Contact closed ■; Contact open □. NOTE: Bar chart measurements are in millimeters.

* Requires an 18PA1-4C Terminal Block (20 mm conduit threads) or 18PA1-4PG Terminal Block (PG13,5 conduit threads) ordered separately. Terminal block is base receptacle.

Table 18. Top Roller Plunger

	Compact 20 mm conduit	Compact PG 13,5 conduit	Plug-in less base*	Description	Electrical Rating (Table 2)	Operating Torque or Force
	5LS1-4C	5LS1-4PG	205LS1-4	Top roller plunger (SST)	J	31,4 N [7.06 lb]
	-	5LS1-G-4PG	-	Top roller plunger (SST)	F	31,4 N [7.06 lb]
	5LS1-4CN152	-	-	Top roller plunger (SST)	J	31,4 N [7.06 lb]

1 Contact closed ■; Contact open □. NOTE: Bar chart measurements are in millimeters.

* Requires an 18PA1-4C Terminal Block (20 mm conduit threads) or 18PA1-4PG Terminal Block (PG13,5 conduit threads) ordered separately. Terminal block is base receptacle.

MICRO SWITCH™ General Purpose Limit Switches

- O.T. • Operating torque
- O.F. • Operating force
- R.P. • Release point
- P.T. • Pretravel
- O.T. • Overtravel
- D.T. • Differential travel

Operating Torque or Force	Bar Chart ¹	Operate Point	Pretravel (max.)	Overtravel (min.)	Differential Travel (max.)	Notes
0,51 N m [4.5 in-lb]		-	20°	30°	12°	
0,51 N m [4.5 in-lb]		-	5°	30°	4°	Low pretravel

Bar Chart ¹	Free Position (nom.)	Operate Point	Pretravel (max.)	Overtravel (min.)	Differential Travel (max.)	Notes
	35,5 mm [1.40 in]	33,8 mm ±0,7 mm [1.33 in ±0.03 in]	1,70 mm [0.067 in]	6,40 mm [0.252 in]	0,50 mm [0.02 in]	
	35,5 mm [1.40 in]	33,8 mm ±0,7 mm [1.33 in ±0.03 in]	1,70 mm [0.067 in]	6,40 mm [0.252 in]	0,50 mm [0.02 in]	Gold-plated contacts, low-energy loads
	35,5 mm [1.40 in]	33,8 mm ±0,7 mm [1.33 in ±0.03 in]	1,70 mm [0.067 in]	6,40 mm [0.252 in]	0,50 mm [0.02 in]	High temperature, 150 °C [302 °F]

Bar Chart ¹	Free Position (nom.)	Operate Point	Pretravel (max.)	Overtravel (min.)	Differential Travel (max.)	Notes
	45,7 mm [1.80 in]	44,0 mm ±0,7 mm [1.73 in ±0.03 in]	1,70 mm [0.067 in]	5,56 mm [0.219 in]	0,50 mm [0.02 in]	
	45,7 mm [1.80 in]	44,0 mm ±0,7 mm [1.73 in ±0.03 in]	1,70 mm [0.067 in]	5,56 mm [0.219 in]	0,50 mm [0.02 in]	Gold-plated contacts, low-energy loads
	45,7 mm [1.80 in]	44,0 mm ±0,7 mm [1.73 in ±0.03 in]	1,70 mm [0.067 in]	5,56 mm [0.219 in]	0,50 mm [0.02 in]	High temperature, 150 °C [302 °F]

LS Series

MICRO SWITCH™ LS SERIES ORDER GUIDE/RECOMMENDED LISTINGS (FOR EMEA/EUROPE)

For listings not shown, contact your Honeywell representative.

Table 19. Side Plunger

	Compact 20 mm conduit	Compact PG 13,5 conduit	Plug-in less base*	Description	Electrical Rating (Table 2)	Operating Torque or Force
	4LS1-4C	4LS1-4PG	204LS1-4	Side pin plunger (SST)	J	40,1 N [9.01 lb]
	3LS1-4C	3LS1-4PG	203LS1-4	Side roller plunger (SST)	J	40,1 N [9.01 lb]

¹Contact closed ■; Contact open □. NOTE: Bar chart measurements are in millimeters.

* Requires an 18PA1-4C Terminal Block (20 mm conduit threads) or 18PA1-4PG Terminal Block (PG13,5 conduit threads) ordered separately. Terminal block is base receptacle.

Table 20. Wobble, Coil Spring

	Compact 20 mm conduit	Compact PG 13,5 conduit	Plug-in less base*	Description	Electrical Rating (Table 2)
	8LS1-4C	8LS1-4PG	208LS1-4	Wobble, random motion 141 mm [5.55 in] stranded steel cable	J
	8LS3-4C	8LS3-4PG	208LS3-4	Wobble actuated, random motion 141 mm [5.55 in] aluminum rod	J
	8LS125-4C	8LS125-4PG	208LS125-4	Wobble actuated, random motion 191 mm [7.53 in] stainless steel cat whisker	J
	8LS152-4C	8LS152-4PG	208LS152-4	Wobble actuated, random motion 141 mm [5.55 in] stainless steel coil spring	J

¹Contact closed ■; Contact open □. NOTE: Bar chart measurements are in millimeters.

*Requires an 18PA1 Terminal Block (base receptacle) which must be ordered separately. 18PA1 terminal block has 0.5-14 NPT conduit threads.

² Operating position in any direction except pull.

MICRO SWITCH™ General Purpose Limit Switches

- O.T. • Operating torque
- O.F. • Operating force
- R.P. • Release point
- P.T. • Pretravel
- O.T. • Overtravel
- D.T. • Differential travel

Bar Chart ¹	Free Position (nom.)	Operate Point	Pretravel (max.)	Overtravel (min.)	Differential Travel (max.)	Notes
	57,27 mm	54,5 mm ±1,2 mm [2.15 in ±0.047 in]	2,77 mm [0.109 in]	5,56 mm [0.219 in]	1,0 mm [0.039 in]	-
	70,37 mm	67,6 mm ±1,2 mm [2.66 in ±0.047 in]	2,77 mm [0.109 in]	5,56 mm [0.219 in]	1,0 mm [0.039 in]	Roller plunger may be locked in a position through 360°

Operating Torque or Force	Bar Chart ¹	Operate Point ²	Pretravel (max.)	Overtravel (min.)	Differential Travel (max.)	Notes
1,39 N [5.0 oz]		28,6 mm [1.125 in]	28,6 mm [1.125 in]	30,7 mm [1.21 in]	-	-
1,39 N [5.0 oz]		28,6 mm [1.125 in]	28,6 mm [1.125 in]	30,7 mm [1.21 in]	-	-
0,28 N [1.0 oz]		63,5 mm [2.5 in]	63,5 mm [2.5 in]	63,5 mm [2.5 in]	-	-
1,39 N [5.0 oz]		28,6 mm [1.125 in]	28,6 mm [1.125 in]	30,7 mm [1.21 in]	-	-

LS Series

Table 21. Terminal Block, Base Receptacle

	Plug-in less base*	Description
	18PA1	Terminal block (base receptacle) with 0.5-14 NPT conduit thread. For use with 200LS Series
	18PA1-4C	Terminal block (base receptacle) with 20 mm conduit threads. For use with 200LS-4 Series
	18PA1-4PG	Terminal block (base receptacle) with PG13,5 conduit threads. For use with 200LS-4 Series

Table 22. Replacement Levers for Side Rotary Switches

Catalog Listing (North America)	Catalot Listing (EMEA/Europe)	Description
LSZ51D	6PA78-4	Replacement lever for most 1LS switches with fixed length 38,1 mm lever with Ø19 mm steel roller
LSZ52C	6PA44-4	Replacement lever for most 1LS switches w adj. length 38 mm to 90 mm lever with Ø19 mm nylon roller
LSZ54M	6PA43-4	Replacement aluminum rod lever for most 1LS switches w adj. rod with max. length 140 mm
6PA80	6PA80-4	Replacement fork lever for 6LS switches w steel rollers on opposite side
6PA102	6PA102-4	Replacement fork lever for 6LS switches w nylon rollers on same side
6PA82		Fork lever for 6LS switches w steel rollers on same side
LSZ52D		Adjustable length lever 38 mm to 90 mm w Ø19 mm steel roller
LSZ52J		Adjustable length lever 38 mm to 90 mm w Ø25,4 mm nylon roller
LSZ52K		Adjustable length lever 38 mm to 90 mm w Ø38,1 mm nylon roller
LSZ52M		Adjustable length lever 38 mm to 90 mm w Ø50,8 mm rubber roller
LSZ52Y		Adjustable length lever 38 mm to 90 mm w Ø50,8 mm nylon roller
6PA71		Fixed length lever, 38,1 mm length w Ø19 mm nylon roller
6PA121		Fixed length lever, 38,1 mm length w Ø19 mm steel roller
LSZ51L		Fixed length lever, 38,1 mm length w Ø19 mm ball bearing steel roller
6PA144		Fixed length lever, 38,1 mm length w Ø19 mm ball bearing steel roller
6PA63		Adjustable stainless steel rod lever, 330 mm max. length
6PA69		Adjustable stainless steel spring rod lever, 127 mm to 190 mm
6PA57		Manually operated Ø38,1mm aluminum button on a 68,1 mm metal lever

MICRO SWITCH™ General Purpose Limit Switches

Table 23. Replacement Parts (North America Products)

	Contact Block	Contact Block		
Catalog Listing	Compact	Plug-in	Operating Head	Actuator/ Lever
1LS1-L	2MN1-L	–	9PA15	LSZ51D
1LS1 201LS1	2MN1	2MN6	9PA15	LSZ51D
1LS2-L	2MN1-L	–	9PA16*	Note 1
1LS2 201LS2	2MN1	2MN6	9PA16*	Note 1
1LS3-L	2MN1-L	–	–	–
1LS3 201LS3	2MN1	2MN6	9PA16*	LSZ52C
1LS6 201LS6	2MN1	2MN6	–	LSZ51D
1LS9 201LS9	2MN8	2MN13	9PA16*	Note 1
1LS10-L	2MN1-L	–	–	LSZ54M
1LS10 201LS10	2MN1	2MN6	–	LSZ54M
1LS19 201LS19	2MN8	2MN13	9PA15	LSZ51D
1LS23 201LS23	2MN1	2MN6	9PA68*	Note 2
1LS47 201LS47	2MN8	2MN13	–	LSZ54M
1LS53 201LS51	2MN8	2MN13	–	LSZ54M
1LS56 201LS56	2MN8	2MN13	9PA74*	Note 2
1LS58	2MN8	–	9PA16*	LSZ52C
1LS59	2MN8	–	9PA74*	LSZ52C
1LS131	2MN8	–	9PA74*	6PA121
1LS501 201LS501	2MN1	2MN14	9PA15	LSZ51D

* Furnished without actuator

¹ Any auxiliary lever listed can be used

² LSZ54M, 6PA63, 6PA71 or 6PA121 levers only recommended for these catalog listings

Table 24. Replacement Parts (North America Products)

	Contact Block	Contact Block		
Catalog Listing	Compact	Plug-in	Operating Head	Actuator/ Lever
2LS1-L	2MN1-L	–	9PA32	Included w operating head
2LS1 201LS1	2MN1	2MN6	9PA32	
2LS111 201LS111	2MN3	2MN7	–	–
3LS1 203LS1	2MN11	2MN9	9PA45	Included w operating head
4LS1 204LS1	2MN11	2MN9	9PA44	
5LS1-L	2MN1-L	–	9PA33	
5LS1 205LS1	2MN1	2MN6	9PA33	
6LS1 206LS1	2MN1	2MN6	9PA47*	6PA80
6LS2-L	2MN1-L	–	9PA47*	Note 3
6LS2 206LS2	2MN1	2MN6	9PA47*	Note 3
6LS3	2MN1	–	9PA47*	6PA102
7LS1	2MN1	–	9PA15	LSZ51D
8LS1-L	2MN11-L	–	9PA58	Included w operating head
8LS1 208LS1	2MN11	2MN9	9PA58	
8LS3 208LS3	2MN1	2MN6	9PA49	
8LS125 208LS125	2MN11	2MN9	9PA54	
8LS152 208LS152	2MN1	2MN6	9PA42	

* Furnished without actuator

³ Fork lever actuators recommended for two position side rotary maintained

LS Series

Table 25. Replacement Parts (European Products)

	Contact Block			
Catalog Listing LS	Catalog Listing 200 LS	Basic Switch (compact only)	Operating Head	Actuator/ Lever
1LS1-4C	201LS1-4	2MN1-M	9PA15-4	6PA78-4
1LS2-4C	201LS2-4	2MN1-M	9PA16-4	–
1LS3-4C	201LS3-4	2MN1-M	9PA16-4	6PA44-4
1LS10-4C	201LS10-4	2MN1-M	9PA40-4	6PA43-4
1LS19-4C	201LS19-4	–	9PA15-4	6PA78-4
1LS23-4C	–	2MN1-M	–	–
1LS47-4C	–	–	9PA40-4	6PA43-4
1LS56-4C	201LS56-4	–	9PA74-	*
1LS243-4C	–	–	914PA15	6PA78-4
1LS244-4C	–	–	914PA15	6PA78-4
2LS1-4C	202LS1-4	2MN1-M	9PA32-4	Included with operating head
3LS1-4C	203LS1-4	–	9PA45-4	
4LS1-4C	204LS1-4	–	9PA44-4	
5LS1-4C	205LS1-4	2MN1-M	9PA33-4	
6LS1-4C	206LS1-4	2MN1-M	9PA46-4	6PA80-4
6LS2-4C	206LS2-4	2MN1-M	9PA47-4	–
6LS3-4C	–	2MN1-M	9PA47-4	6PA102-4
8LS1-4C	208LS1-4	2MN1-M	9PA58-4	Included with operating head
8LS3-4C	208LS3-4	2MN1-M	9PA49-4	
8LS125-4C	208LS125-4	2MN1-M	9PA54-4	
8LS152-4C	208LS152-4	2MN1-M	9PA42-4	

Note: Operating head includes lever where appropriate and internal plunger.

* Because of low operating force, 6PA43-4, 6PA71-4, or 6PA78-4 auxiliary actuators only are recommended for these listings.

MICRO SWITCH™ General Purpose Limit Switches

DIMENSIONAL DRAWINGS

Figure 1. 1LS1 Dimensions



Figure 2. 1LS3 Dimensions



Figure 3. 1LS10 Dimensions



Figure 4. 2LS1 Dimensions

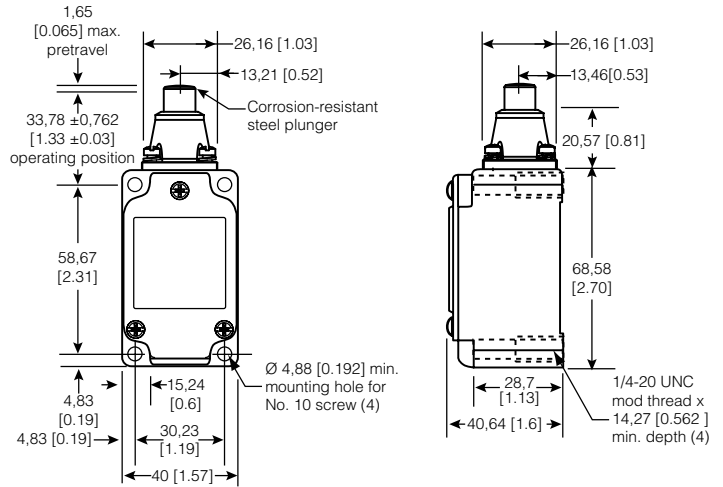

Figure 5. 3LS1 Dimensions

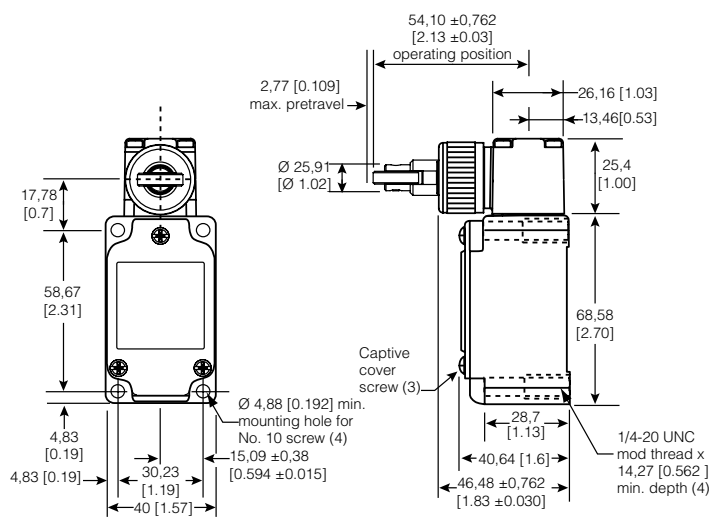
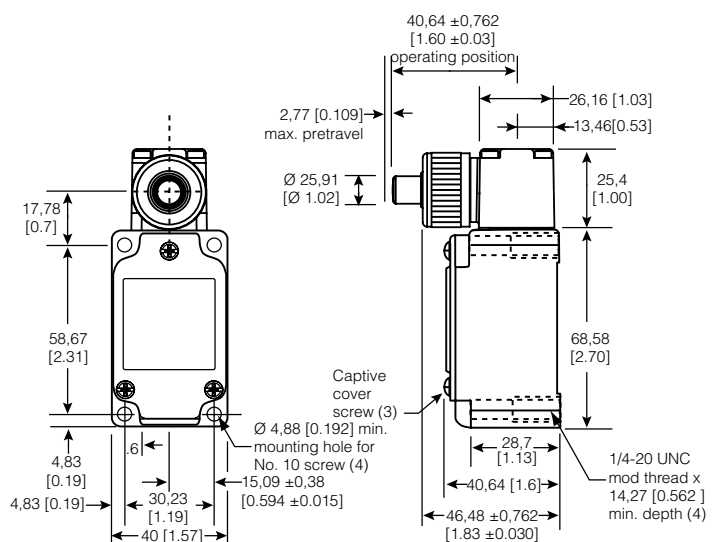

Figure 6. 4LS1 Dimensions



LS Series

Figure 7. 5LS1 Dimensions



Figure 6. 6LS1 Dimensions



Figure 7. 7LS1 Dimensions



Figure 8. 8LS1 Dimensions

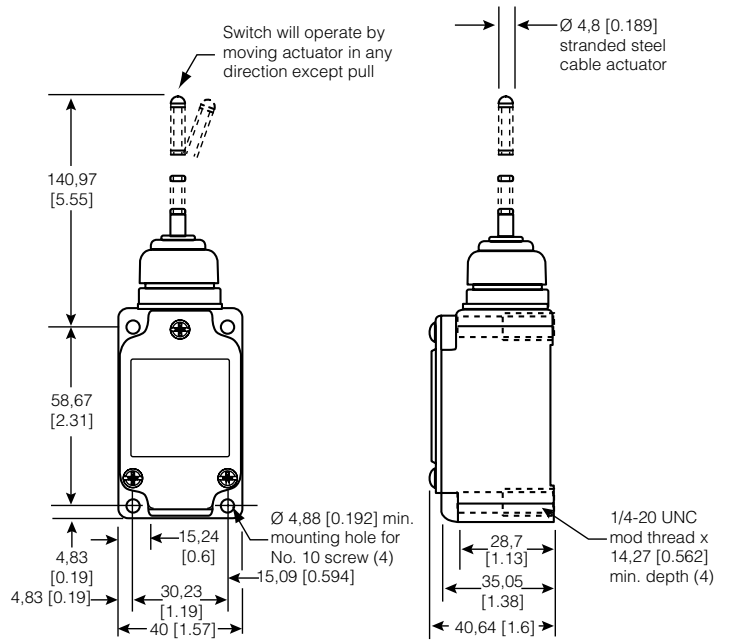
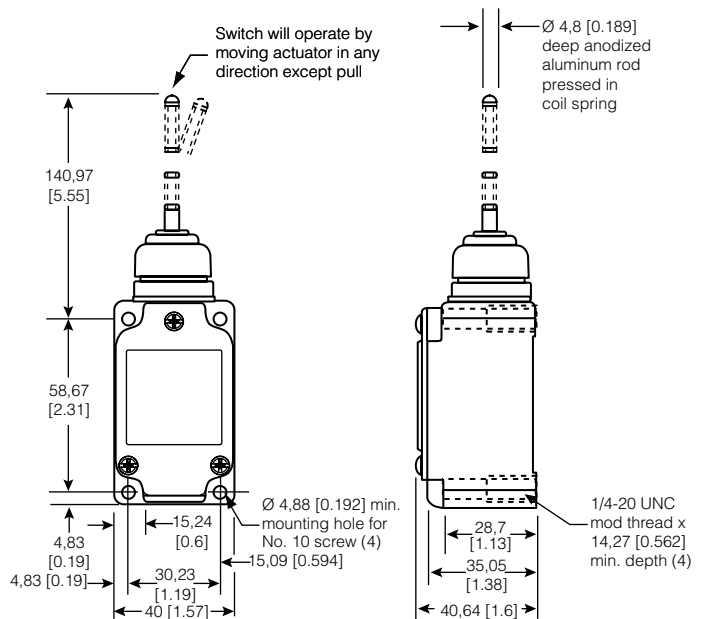

Figure 9. 8LS3 Dimensions



MICRO SWITCH™ General Purpose Limit Switches

Figure 10. 8LS125 Dimensions



Figure 12. 201LS1 Dimensions



Figure 11. 8LS152 Dimensions

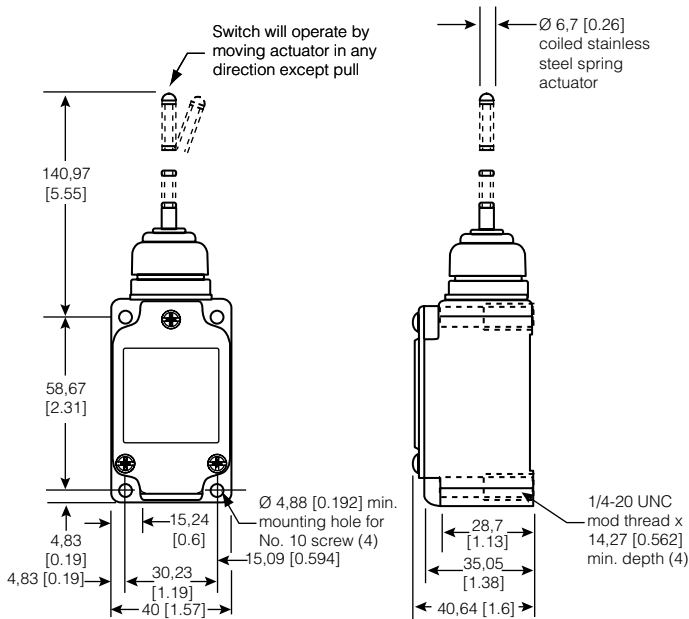

Figure 13. 201LS3 Dimensions



LS Series

Figure 14. 201LS10 Dimensions



Figure 17. 204LS1 Dimensions



Figure 15. 202LS1 Dimensions



Figure 18. 205LS1 Dimensions



Figure 16. 203LS1 Dimensions



Figure 19. 206LS1 Dimensions



MICRO SWITCH™ General Purpose Limit Switches

Figure 20. 208LS1 Dimensions



Figure 22. 208LS125 Dimensions



Figure 21. 208LS3 Dimensions



Figure 23. 208LS152 Dimensions



Figure 24. 1LS2-4 Dimensions



Figure 25. 1LS3-4 Dimensions

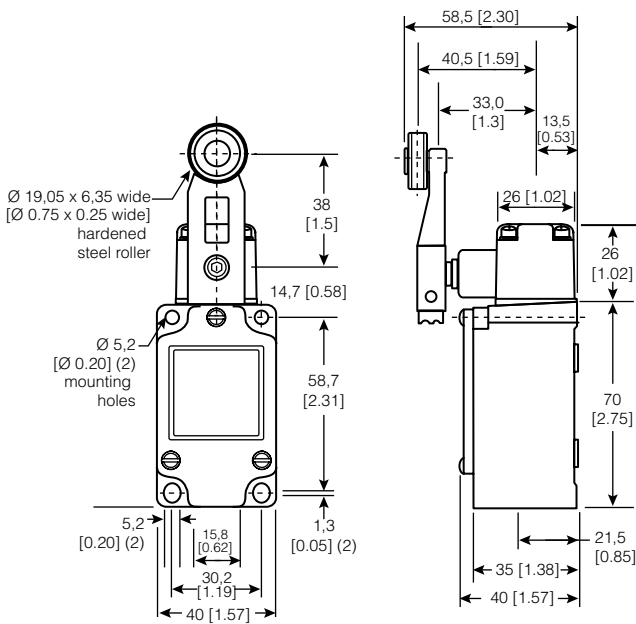

Figure 26. 1LS10-4 Dimensions



Figure 27. 2LS1-4 Dimensions



Figure 28. 4LS1-4 Dimensions



MICRO SWITCH™ General Purpose Limit Switches

Figure 29. 5LS1-4 Dimensions



Figure 30. 6LS1-4 Dimensions



Figure 31. 8LS1-4 Dimensions



Figure 32. 201LS1-4 Dimensions



Figure 33. 206LS1-4 Dimensions

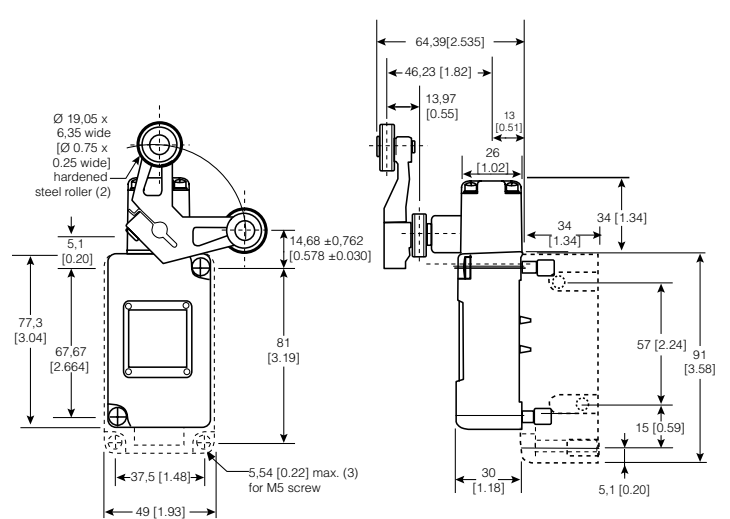
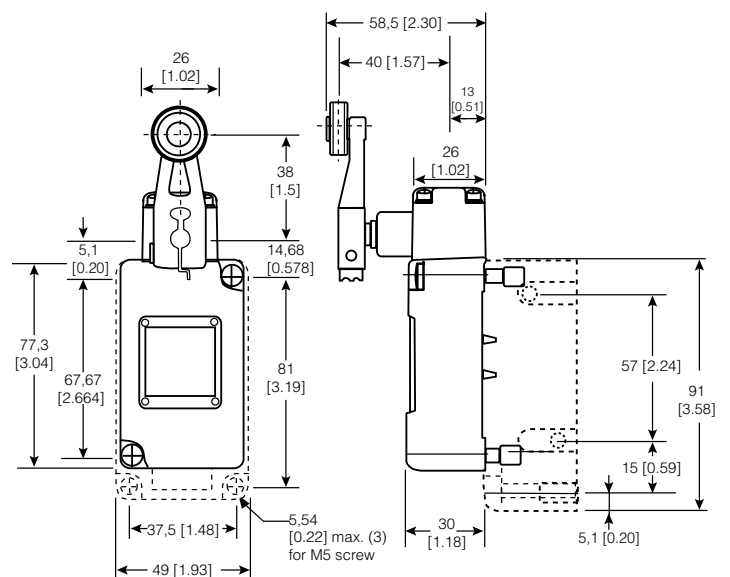

Figure 34. 201LS3-4 Dimensions



LS Series

Figure 35. 201LS10-4 Dimensions



Figure 36. 202LS1-4 Dimensions



Figure 37. 204LS1-4 Dimensions



Figure 38. 205LS1-4 Dimensions



Figure 39. 208LS1-4 Dimensions



ADDITIONAL INFORMATION

The following associated literature is available on the Honeywell web site at sensing.honeywell.com:

- Product installation instructions
- Aerospace range guide
- Transportation range guide
- Limits and Machine Safety range guide
- Product application-specific information
 - Application Note: Automated Storage and Retrieval System
 - Limit and Enclosed Switches Application Information
 - Limit and Enclosed Switches Operating Characteristics
 - Limit and Enclosed Switches Reference Standards
 - Limit and Enclosed Switches Typical Applications

Find out more

Honeywell serves its customers through a worldwide network of sales offices, representatives and distributors. For application assistance, current specifications, pricing or name of the nearest Authorized Distributor, contact your local sales office.

To learn more about Honeywell's sensing and control products, call **+1-815-235-6847** or **1-800-537-6945**, visit **sensing.honeywell.com**, or e-mail inquiries to **info.sc@honeywell.com**

Sensing and Control
Honeywell
1985 Douglas Drive North
Golden Valley, MN 55422
honeywell.com

WARNING **PERSONAL INJURY**

DO NOT USE these products as safety or emergency stop devices or in any other application where failure of the product could result in personal injury.

Failure to comply with these instructions could result in death or serious injury.

WARNING **MISUSE OF DOCUMENTATION**

- The information presented in this product sheet is for reference only. Do not use this document as a product installation guide.
- Complete installation, operation, and maintenance information is provided in the instructions supplied with each product.

Failure to comply with these instructions could result in death or serious injury.

WARRANTY/REMEDY

Honeywell warrants goods of its manufacture as being free of defective materials and faulty workmanship. Honeywell's standard product warranty applies unless agreed to otherwise by Honeywell in writing; please refer to your order acknowledgement or consult your local sales office for specific warranty details. If warranted goods are returned to Honeywell during the period of coverage, Honeywell will repair or replace, at its option, without charge those items it finds defective. **The foregoing is buyer's sole remedy and is in lieu of all other warranties, expressed or implied, including those of merchantability and fitness for a particular purpose. In no event shall Honeywell be liable for consequential, special, or indirect damages.**

While we provide application assistance personally, through our literature and the Honeywell website, it is up to the customer to determine the suitability of the product in the application.

Specifications may change without notice. The information we supply is believed to be accurate and reliable as of this printing. However, we assume no responsibility for its use.

Honeywell