

**SF2137E-2**

**869.00 MHz  
SAW Filter**

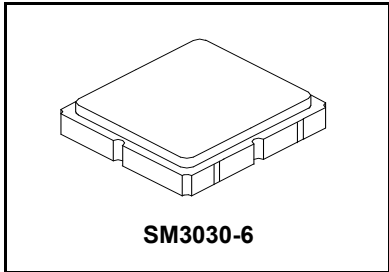

- Steep Roll-off SAW Filter for 869.00 MHz Unlicensed Band
- Complies with Directive 2002/95/EC (RoHS)
- No Matching Required for Operation in 50Ω Environment
- Complies with AEC-Q200



**A1 Maximum Ratings**

Rating	Value	Units
Input Power Level	13	dBm
DC Voltage on any Non-ground Terminal	5	V
Operable Temperature	-45 to +125	°C
Storage Temperature Range in Tape and Reel	-40 to +85	°C
Soldering Profile Maximum Temperature, 5 cycles/10 s maximum	265	°C

**B1 Electrical Characteristics**

Operating Temperature Range -40°C to +85°C

Characteristic	Sym	Notes	Min	Typ	Max	Units
Center Frequency	$f_C$			869.00		MHz
Insertion Loss, 868 to 870 MHz	IL			2.3	3.0	dB
Amplitude Ripple, 868 to 870 MHz				0.3	0.6	dB <sub>p-p</sub>
Attenuation Referenced to 0 dB:						
100 to 300 MHz			45	50		dB
300 to 845 MHz			40	45		
845 to 853 MHz			38	43		
879 to 883 MHz			15	30		
883 to 915 MHz			40	45		
915 to 945 MHz			45	50		
945 to 1200 MHz			45	55		
1200 to 2000 MHz			35	40		
Source Impedance	$Z_S$			50		Ω
Load Impedance	$Z_L$			50		Ω

Case Style	SM3030-6 3.0 x 3.0 mm Nominal Footprint					
Lid Symbolization, Y=year, WW=week, S=shift, Dot=pin 1 indicator	B16, <u>Y</u> WWS					
Standard Reel Quantity	Reel Size 7 Inch	500 Pieces/Reel				
	Reel Size 13 Inch	3000 Pieces/Reel				

**Electrical Connections**

Connection	Terminals
Port 1 (Input)	2
Port 2 (Output)	5
Case Ground	All others

**Test Circuit**

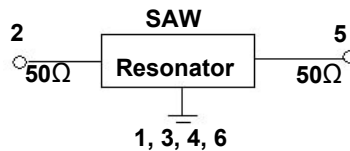

**CAUTION: Electrostatic Sensitive Device. Observe precautions for handling.**

**NOTES:**

1. Unless noted otherwise, all specifications apply over the operating temperature range with filter soldered to the specified demonstration board with impedance matching to 50 Ω and measured with 50 Ω network analyzer.
2. Unless noted otherwise, all frequency specifications are referenced to the nominal center frequency,  $f_C$ .
3. Rejection is measured as attenuation below the minimum IL point in the passband. Rejection in final user application is dependent on PCB layout and external impedance matching design. See Application Note No. 42 for details.
4. The design, manufacturing process, and specifications of this filter are subject to change.
5. US and international patents may apply.
6. Murata, stylized Murata logo, and Murata N.A., Inc. are registered trademarks of Murata Manufacturing Co., Ltd.

## A2 Maximum Ratings

Rating	Value	Units
Input Power Level	13	dBm
DC Voltage on any Non-ground Terminal	5	V
Operable Temperature	-45 to +125	°C
Storage Temperature Range in Tape and Reel	-40 to +85	°C
Soldering Profile Maximum Temperature, 5 cycles/10 s maximum	265	°C

## B2 Electrical Characteristics

Operating Temperature Range -20°C to +70°C

Characteristic	Sym	Notes	Min	Typ	Max	Units
Center Frequency	$f_C$			869.00		MHz
Insertion Loss, 868 to 870 MHz	IL			2.3	3.0	dB
Amplitude Ripple, 868 to 870 MHz				0.3	0.6	dB <sub>P-P</sub>
Attenuation Referenced to 0 dB:						
100 to 300 MHz			45	50		dB
300 to 845 MHz			40	45		
845 to 853 MHz			38	43		
879 to 883 MHz			20	30		
883 to 915 MHz			40	45		
915 to 945 MHz			45	50		
945 to 1200 MHz			45	55		
1200 to 2000 MHz			35	40		
Source Impedance	$Z_S$			50		$\Omega$
Load Impedance	$Z_L$			50		$\Omega$

Case Style	SM3030-6 3.0 x 3.0 mm Nominal Footprint		
Lid Symbolization, Y=year, WW=week, S=shift, Dot=pin 1 indicator	B16, YWWS		
Standard Reel Quantity	Reel Size 7 Inch	500 Pieces/Reel	
	Reel Size 13 Inch	3000 Pieces/Reel	

## Electrical Connections

Connection	Terminals
Port 1 (Input)	2
Port 2 (Output)	5
Case Ground	All others

## Test Circuit

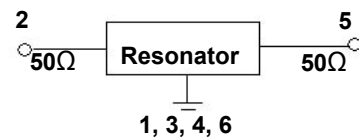

## Frequency Characteristics

### S21 Response: (Span 200 MHz)

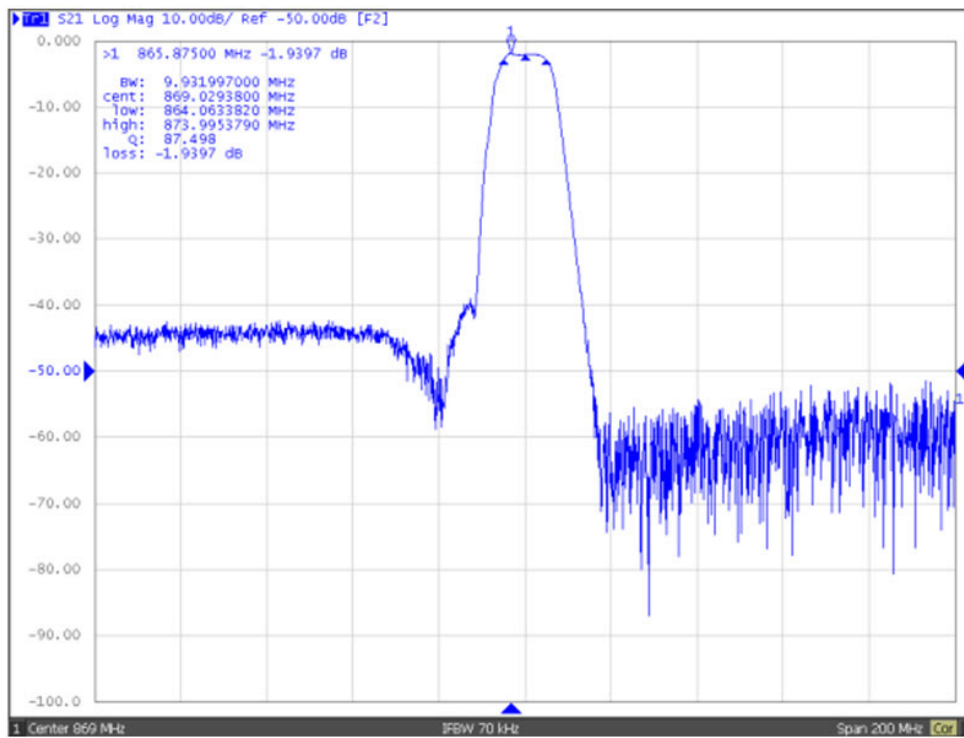

### S21 Response: (Span 100 MHz)

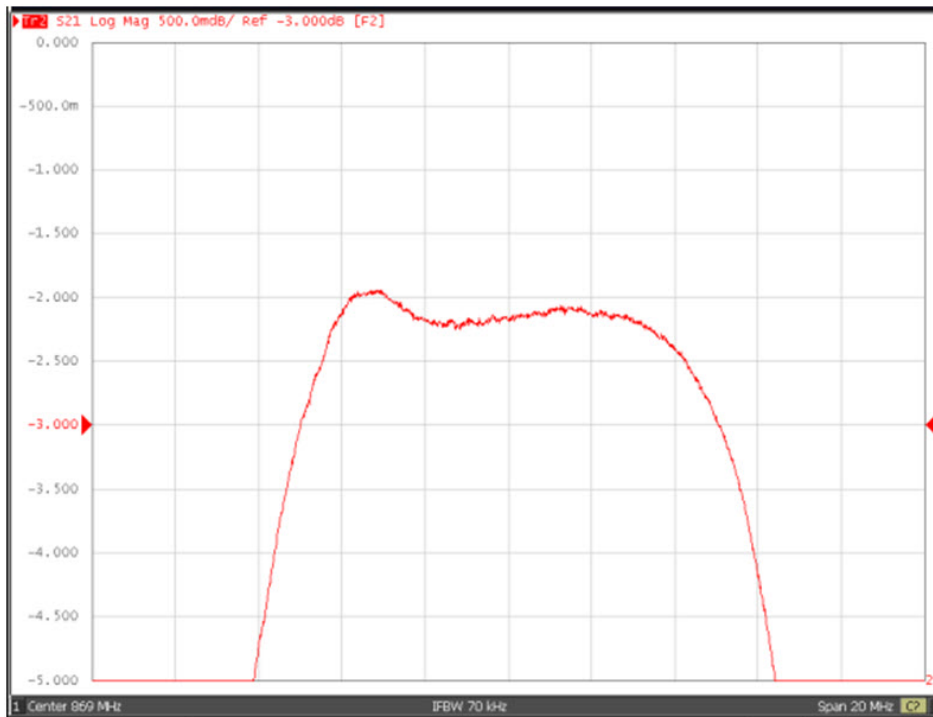

### S21 Response: (Span 100 MHz)

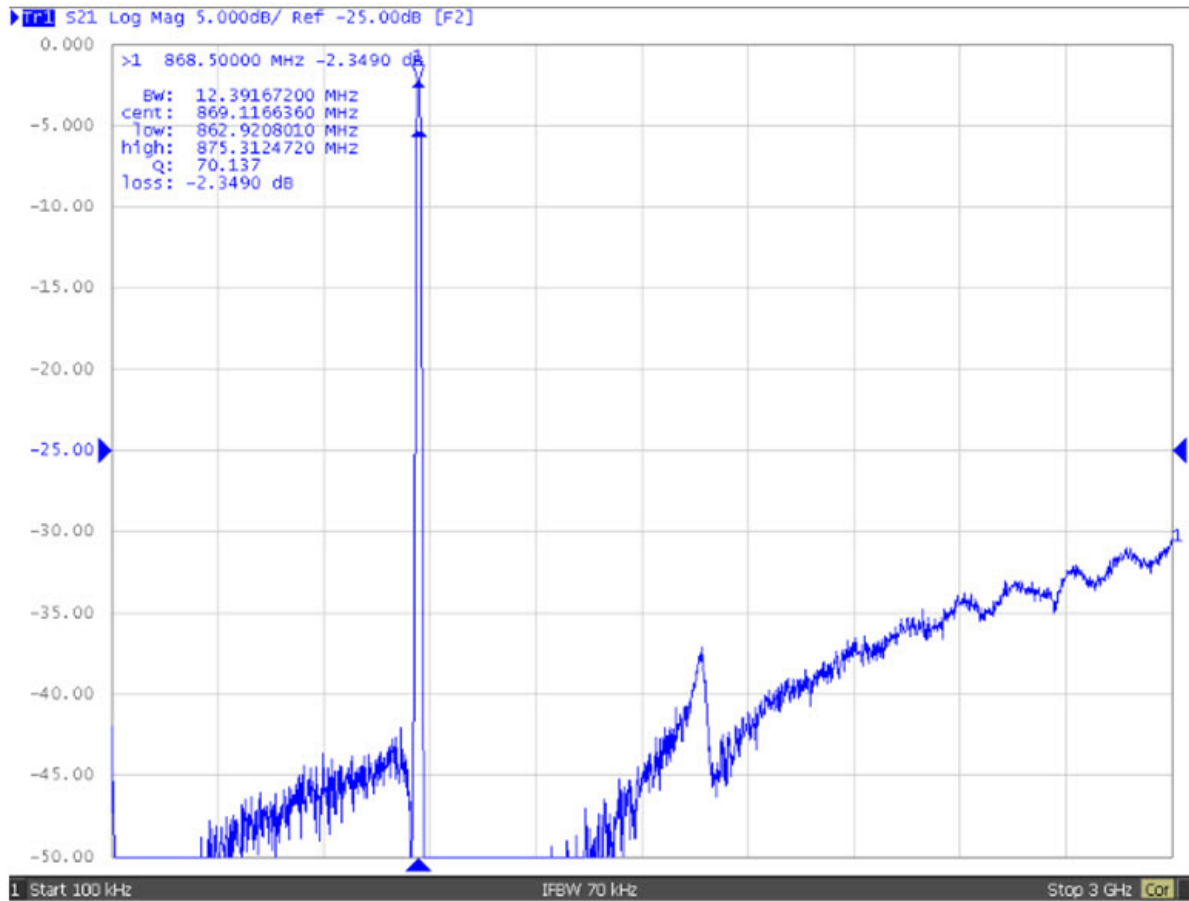

### S11/S22 Response:

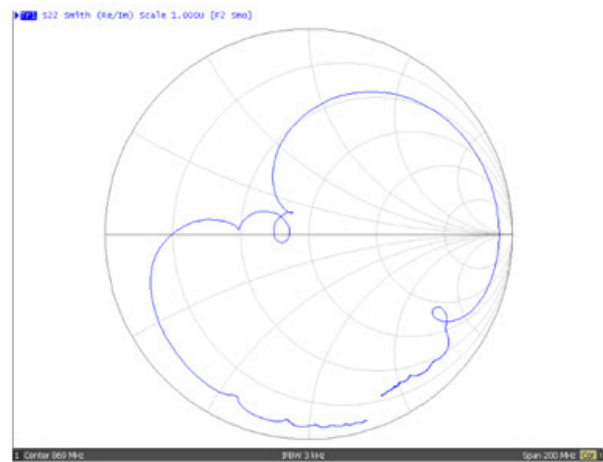
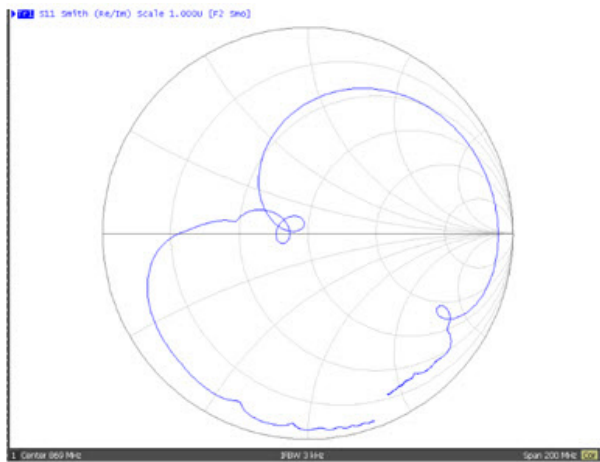

# SM3030-6 Case

## 6-Terminal Ceramic Surface-Mount Case 3.0 X 3.0 mm Nominal Footprint

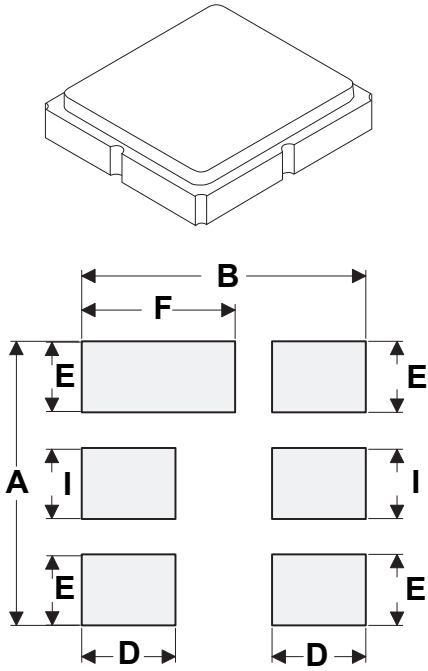

PCB Footprint Top View

### Case and PCB Footprint Dimensions

Dimension	mm			Inches		
	Min	Nom	Max	Min	Nom	Max
A	2.85	3.00	3.15	0.112	0.118	0.124
B	2.85	3.00	3.15	0.112	0.118	0.124
C	1.12	1.25	1.40	0.044	0.049	0.055
D	0.60	0.75	0.90	0.023	0.029	0.035
E	0.38	0.53	0.68	0.0104	0.020	0.004
F	1.05	1.20	1.35	0.041	0.047	0.053
G		0.15			0.005	
H		0.45			0.017	
I	0.55	0.60	0.65	0.021	0.023	0.025

### Case Materials

Materials	
Solder Pad Plating	0.3 to 1.0 $\mu$ m Gold over 1.27 to 8.89 $\mu$ m Nickel
Lid Plating	2.0 to 3.0 $\mu$ m Nickel
Body	Al <sub>2</sub> O <sub>3</sub> Ceramic
	Pb Free

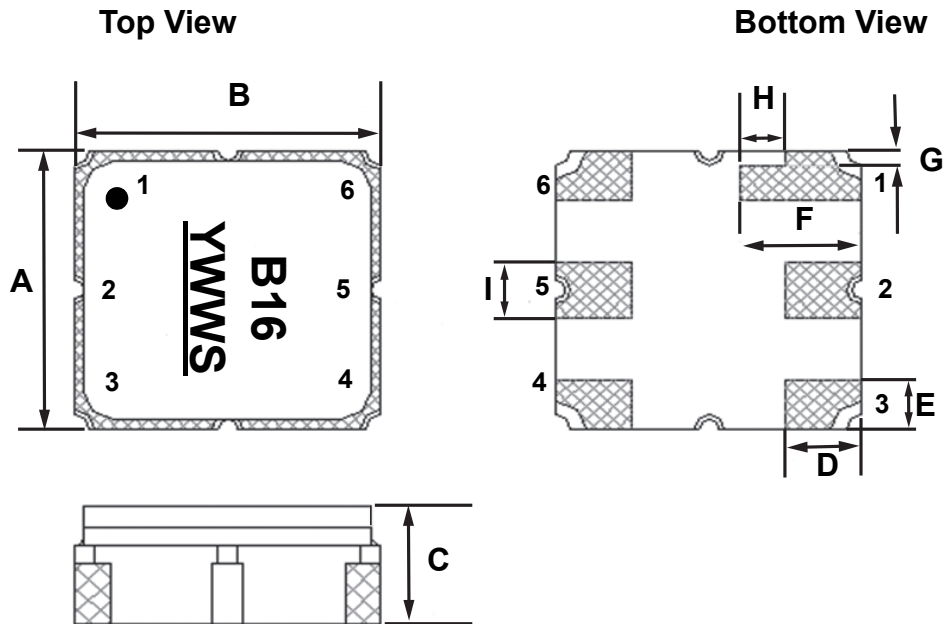

## Tape and Reel Specifications

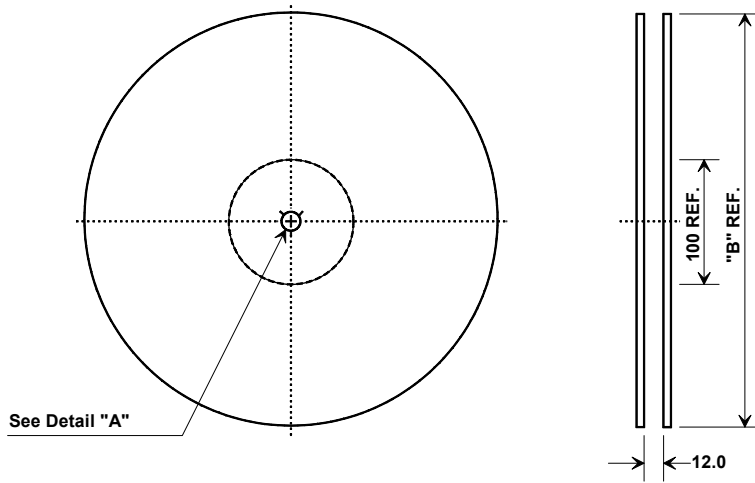

"B"		Quantity Per Reel
Inches	millimeters	
7	178	500
13	330	3000

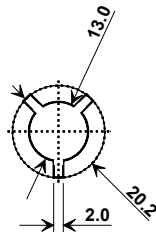

## COMPONENT ORIENTATION and DIMENSIONS

Carrier Tape Dimensions	
Ao	4.25 mm
Bo	4.25 mm
Ko	1.30 mm
Pitch	8.0 mm
W	12.0 mm

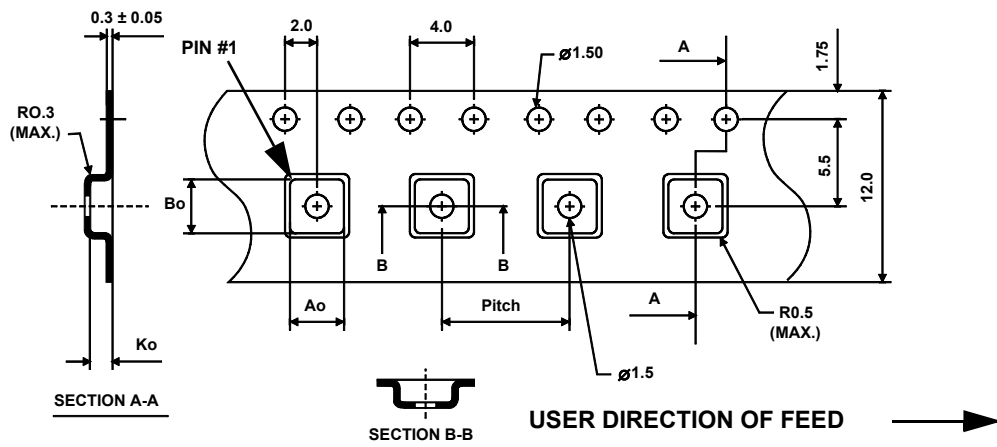

## Typical Solder Reflow Profile

