

X9317

Low Noise, Low Power, 100 Taps, Digitally Controlled Potentiometer (XDCP™)

FN8183  
Rev.10.00  
Dec 17, 2018

The X9317 is a digitally controlled potentiometer (XDCP™). The device consists of a resistor array, wiper switches, a control section, and nonvolatile memory. The wiper position is controlled by a 3-wire interface.

The potentiometer is implemented by a resistor array composed of 99 resistive elements and a wiper switching network. Between each element and at either end are tap points accessible to the wiper terminal. The position of the wiper element is controlled by the  $\overline{CS}$ ,  $U/\overline{D}$ , and  $\overline{INC}$  inputs. The position of the wiper can be stored in nonvolatile memory and then be recalled upon a subsequent power-up operation.

The device can be used as a three-terminal potentiometer for voltage control or as a two-terminal variable resistor for current control in a wide variety of applications.

**Applications**

- LCD bias control
- DC bias adjustment
- Gain and offset trim
- Laser diode bias control
- Voltage regulator output control

**Features**

- Solid-state potentiometer
- 3-wire serial up/down interface
- 100 wiper tap points
  - Wiper position stored in nonvolatile memory and recalled on power-up
- 99 resistive elements
  - Temperature compensated
  - End-to-end resistance range  $\pm 20\%$
- Low power CMOS
  - $V_{CC} = 2.7V$  to  $5.5V$ , and  $5V \pm 10\%$
  - Standby current  $< 5\mu A$
- High reliability
  - Endurance, 100,000 data changes per bit
  - Register data retention, 100 years
- $R_{TOTAL}$  values =  $10k\Omega$ ,  $50k\Omega$ ,  $100k\Omega$
- Packages
  - 8 Ld SOIC, TSSOP, and MSOP
- Pb-free (RoHS compliant)

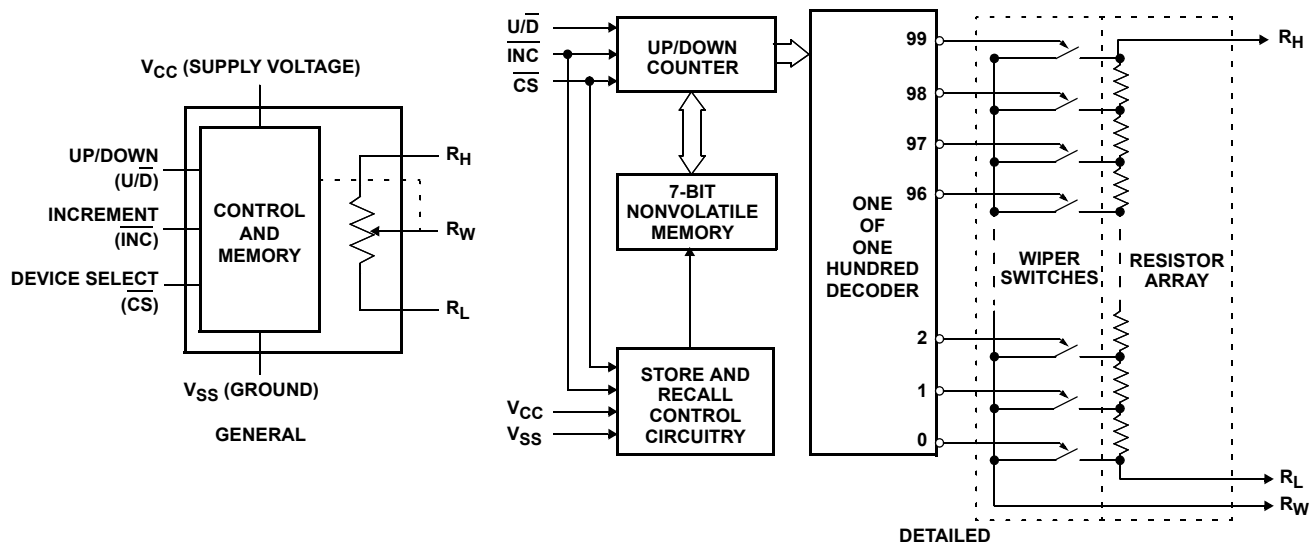

FIGURE 1. BLOCK DIAGRAM

## Ordering Information

PART NUMBER (Notes 1, 2, 3)	PART MARKING	V <sub>CC</sub> LIMITS (V)	R <sub>TOTAL</sub> (kΩ)	TEMPERATURE RANGE (°C)	PACKAGE (RoHS Compliant)	PKG. DWG. #		
X9317WM8Z	DCW	5 ±10%	10	0 to +70	8 Ld MSOP	M8.118		
X9317WM8IZ	DCT			-40 to +85	8 Ld MSOP	M8.118		
X9317WS8Z	X9317W Z			0 to +70	8 Ld SOIC	M8.15E		
X9317WS8IZ	X9317W ZI			-40 to +85	8 Ld SOIC	M8.15E		
X9317WV8Z	9317W Z			0 to +70	8 Ld TSSOP	M8.173		
X9317WV8IZ	9317W IZ			-40 to +85	8 Ld TSSOP	M8.173		
X9317US8Z	X9317U Z			0 to +70	8 Ld SOIC	M8.15E		
X9317US8IZ	X9317U ZI			-40 to +85	8 Ld SOIC	M8.15E		
X9317UV8Z	9317U Z			0 to +70	8 Ld TSSOP	M8.173		
X9317UV8IZ	9317U IZ			-40 to +85	8 Ld TSSOP	M8.173		
X9317WM8Z-2.7	DCX			2.7 to 5.5	10	0 to +70	8 Ld MSOP	M8.118
X9317WM8IZ-2.7	DCU					-40 to +85	8 Ld MSOP	M8.118
X9317WS8Z-2.7	X9317W ZF	0 to +70	8 Ld SOIC			M8.15E		
X9317WS8IZ-2.7	X9317W ZG	-40 to +85	8 Ld SOIC			M8.15E		
X9317WV8Z-2.7	9317W FZ	0 to +70	8 Ld TSSOP			M8.173		
X9317WV8IZ-2.7	AKZ	-40 to +85	8 Ld TSSOP			M8.173		
X9317US8Z-2.7	X9317U ZF	0 to +70	8 Ld SOIC			M8.15E		
X9317US8IZ-2.7	X9317U ZG	-40 to +85	8 Ld SOIC			M8.15E		
X9317UV8Z-2.7	9317U FZ	0 to +70	8 Ld TSSOP			M8.173		
X9317UV8IZ-2.7	9317U GZ	-40 to +85	8 Ld TSSOP			M8.173		

### NOTES:

1. Add "T1" suffix for tape and reel. Please refer to [TB347](#) for details on reel specifications.
2. These Pb-free plastic packaged products employ special Pb-free material sets, molding compounds/die attach materials, and 100% matte tin plate plus anneal (e3 termination finish, which is RoHS compliant and compatible with both SnPb and Pb-free soldering operations). Pb-free products are MSL classified at Pb-free peak reflow temperatures that meet or exceed the Pb-free requirements of IPC/JEDEC J STD-020.
3. For Moisture Sensitivity Level (MSL), please see device information page for [X9317](#). For more information on MSL please see tech brief [TB363](#).

## Pin Configurations

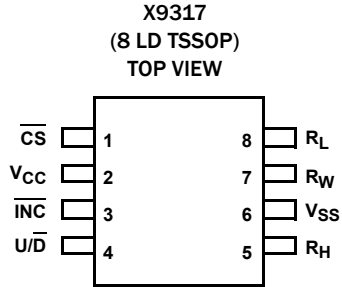

## Pin Descriptions

SOIC/MSOP	TSSOP	SYMBOL	BRIEF DESCRIPTION
1	3	$\overline{INC}$	<b>Increment</b> Toggling $\overline{INC}$ while $\overline{CS}$ is low moves the wiper either up or down.
2	4	$U/\overline{D}$	<b>Up/Down</b> The $U/\overline{D}$ input controls the direction of the wiper movement.
3	5	$R_H$	The high terminal is equivalent to one of the fixed terminals of a mechanical potentiometer.
4	6	$V_{SS}$	<b>Ground</b>
5	7	$R_W$	The wiper terminal is equivalent to the movable terminal of a mechanical potentiometer.
6	8	$R_L$	The low terminal is equivalent to one of the fixed terminals of a mechanical potentiometer.
7	1	$\overline{CS}$	<b>Chip Select</b> The device is selected when the $\overline{CS}$ input is LOW, and de-selected when $\overline{CS}$ is high.
8	2	$V_{CC}$	<b>Supply Voltage</b>

## Absolute Maximum Ratings

$I_W$ (10s)	±8.8mA
$R_H$ , $R_W$ , $R_L$ to Ground	+6V
Voltage on $\overline{CS}$ , $\overline{INC}$ , $U/\overline{D}$ and $V_{CC}$ with Respect to $V_{SS}$	-1V to +7V

## Thermal Information

Thermal Resistance (Typical)	$\theta_{JA}$ (°C/W)	$\theta_{JC}$ (°C/W)
SOIC Package (Notes 4, 5)	115	60
MSOP Package (Notes 4, 5)	145	55
TSSOP Package (Notes 4, 5)	155	49
Junction Temperature Under Bias	-65°C to +135°C	
Storage Temperature	-65°C to +150°C	
Pb-Free Reflow Profile	see <a href="#">TB493</a>	

CAUTION: Do not operate at or near the maximum ratings listed for extended periods of time. Exposure to such conditions may adversely impact product reliability and result in failures not covered by warranty.

### NOTES:

- $\theta_{JA}$  is measured with the component mounted on a high effective thermal conductivity test board in free air. See Tech Brief [TB379](#) for details.
- For  $\theta_{JC}$ , the "case temp" location is taken at the package top center.

## Potentiometer Specifications $V_{CC}$ = full range. Boldface limits apply across the operating temperature range, -40°C to +85°C (Industrial) and 0°C to +70°C (Commercial).

SYMBOL	PARAMETER	TEST CONDITIONS/NOTES	MIN (Note 13)	TYP (Note 9)	MAX (Note 13)	UNIT
$R_{TOTAL}$	End-to-end Resistance Tolerance	See "Ordering Information" on <a href="#">page 2</a> for values	<b>-20</b>		<b>+20</b>	%
$V_{RH/RL}$	$R_H/R_L$ Terminal Voltage	$V_{SS} = 0V$	<b><math>V_{SS}</math></b>		<b><math>V_{CC}</math></b>	V
	Power Rating	$R_{TOTAL} \geq 10k\Omega$			<b>10</b>	mW
$R_W$	Wiper Resistance	$I_W = [V(R_H) - V(R_L)] / R_{TOTAL}$ , $V_{CC} = 5V$		200	<b>400</b>	$\Omega$
		$I_W = [V(R_H) - V(R_L)] / R_{TOTAL}$ , $V_{CC} = 2.7V$		400	<b>1000</b>	$\Omega$
$I_W$	Wiper Current ( <a href="#">Note 10</a> )	See " <a href="#">Test Circuit</a> " on <a href="#">page 5</a>	<b>-4.4</b>		<b>+4.4</b>	mA
	Noise ( <a href="#">Note 12</a> )	Ref: 1kHz		-120		dBV
	Resolution			1		%
	Absolute Linearity ( <a href="#">Note 6</a> )	$V(R_H) = V_{CC}$ , $V(R_L) = 0V$	<b>-1</b>		<b>+1</b>	MI ( <a href="#">Note 8</a> )
	Relative Linearity ( <a href="#">Note 7</a> )	$V(R_H) = V_{CC}$ , $V(R_L) = 0V$	<b>-0.2</b>		<b>+0.2</b>	MI ( <a href="#">Note 8</a> )
	$R_{TOTAL}$ Temperature Coefficient ( <a href="#">Note 10</a> )	$V(R_H) = V_{CC}$ , $V(R_L) = 0V$		±300		ppm/°C
	Ratiometric Temperature Coefficient ( <a href="#">Notes 10, 11</a> )			±20		ppm/°C
$C_H/C_L/C_W$ ( <a href="#">Note 10</a> )	Potentiometer Capacitances	See " <a href="#">Equivalent Circuit</a> " on <a href="#">page 5</a>		10/10/25		pF
$V_{CC}$	Supply Voltage	X9317	<b>4.5</b>		<b>5.5</b>	V
		X9317-2.7	<b>2.7</b>		<b>5.5</b>	V

**DC Electrical Specifications**  $V_{CC} = 5V \pm 10\%$ . **Boldface limits apply across the operating temperature range, -40 °C to +85 °C (Industrial) and 0 °C to +70 °C (Commercial).**

SYMBOL	PARAMETER	TEST CONDITIONS	MIN (Note 13)	TYP (Note 9)	MAX (Note 13)	UNIT
$I_{CC1}$	$V_{CC}$ Active Current (Increment)	$\overline{CS} = V_{IL}$ , $U/\overline{D} = V_{IL}$ or $V_{IH}$ and $\overline{INC} = V_{IL}/V_{IH}$ at min. $t_{CYC}$ $R_L, R_H, R_W$ not connected			<b>80</b>	$\mu A$
$I_{CC2}$	$V_{CC}$ Active Current (Store) (non-volatile write)	$\overline{CS} = V_{IH}$ , $U/\overline{D} = V_{IL}$ or $V_{IH}$ and $\overline{INC} = V_{IL}$ or $V_{IH}$ . $R_L, R_H, R_W$ not connected			<b>400</b>	$\mu A$
$I_{SB}$	Standby Supply Current	$\overline{CS} \geq V_{IH}$ , $U/\overline{D}$ and $\overline{INC} = V_{IL}$ $R_L, R_H, R_W$ not connected			<b>5</b>	$\mu A$
$I_{LI}$	$\overline{CS}, \overline{INC}, U/\overline{D}$ Input Leakage Current	$V_{IN} = V_{SS}$ to $V_{CC}$	<b>-10</b>		<b>+10</b>	$\mu A$
$V_{IH}$	$\overline{CS}, \overline{INC}, U/\overline{D}$ Input HIGH Voltage		$V_{CC} \times 0.7$		$V_{CC} + 0.5$	V
$V_{IL}$	$\overline{CS}, \overline{INC}, U/\overline{D}$ Input LOW Voltage		<b>-0.5</b>		$V_{CC} \times 0.1$	V
$C_{IN}$ (Note 10)	$\overline{CS}, \overline{INC}, U/\overline{D}$ Input Capacitance	$V_{CC} = 5V, V_{IN} = V_{SS}, T_A = +25^\circ C, f = 1MHz$		10		pF

**Endurance and Data Retention**  $V_{CC} = 5V \pm 10\%$ ,  $T_A =$  Full Operating Temperature Range.

PARAMETER	MIN	UNIT
Minimum Endurance	100,000	Data changes per bit
Data Retention	100	Years

**Test Circuit**

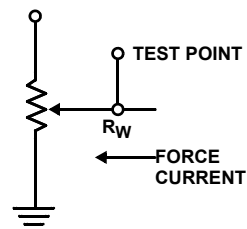

**Equivalent Circuit**

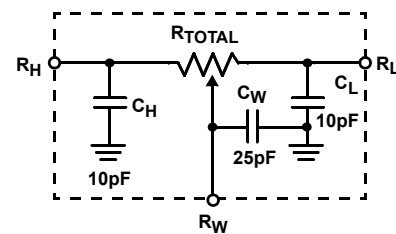

**AC Conditions of Test**

Input pulse levels	0V to 3V
Input rise and fall times	10ns
Input reference levels	1.5V

**AC Electrical Specifications**  $V_{CC} = 5V \pm 10\%$ . **Boldface limits apply across the operating temperature range, -40 °C to +85 °C (Industrial) and 0 °C to +70 °C (Commercial).**

SYMBOL	PARAMETER	MIN (Note 13)	TYP (Note 9)	MAX (Note 13)	UNIT
$t_{CI}$	$\overline{CS}$ to $\overline{INC}$ Setup	<b>50</b>			ns
$t_{ID}$ (Note 10)	$\overline{INC}$ HIGH to $U/\overline{D}$ Change	<b>100</b>			ns
$t_{DI}$ (Note 10)	$U/\overline{D}$ to $\overline{INC}$ Setup	<b>1</b>			$\mu s$
$t_{IL}$	$\overline{INC}$ LOW Period	<b>960</b>			ns
$t_{IH}$	$\overline{INC}$ HIGH Period	<b>960</b>			ns
$t_{IC}$	$\overline{INC}$ Inactive to $\overline{CS}$ Inactive	<b>1</b>			$\mu s$
$t_{CPHS}$	$\overline{CS}$ Deselect Time (STORE)	<b>10</b>			ms
$t_{CPHNS}$ (Note 10)	$\overline{CS}$ Deselect Time (NO STORE)	<b>100</b>			ns
$t_{IW}$	$\overline{INC}$ to $R_W$ Change		<b>1</b>	<b>5</b>	$\mu s$
$t_{CYC}$	$\overline{INC}$ Cycle Time	<b>2</b>			$\mu s$

**AC Electrical Specifications**  $V_{CC} = 5V \pm 10\%$ . **Boldface limits apply across the operating temperature range, -40°C to +85°C (Industrial) and 0°C to +70°C (Commercial).** (Continued)

SYMBOL	PARAMETER	MIN (Note 13)	TYP (Note 9)	MAX (Note 13)	UNIT
$t_R, t_F$ (Note 10)	$\overline{INC}$ Input Rise and Fall Time			<b>500</b>	$\mu s$
$t_{PU}$ (Note 10)	Power-up to Wiper Stable			<b>5</b>	$\mu s$
$t_R V_{CC}$ (Note 10)	$V_{CC}$ Power-up Rate	<b>0.2</b>		<b>50</b>	V/ms
$t_{WR}$	Store Cycle		5	<b>10</b>	ms

## NOTES:

6. Absolute linearity is utilized to determine actual wiper voltage versus expected voltage =  $[V(R_{W(n)(actual)}) - V(R_{W(n)(expected)})] / MI$   
 $V(R_{W(n)(expected)}) = n(V(R_H) - V(R_L)) / 99 + V(R_L)$ , with n from 0 to 99.
7. Relative linearity is a measure of the error in step size between taps =  $[V(R_{W(n+1)}) - (V(R_{W(n)}) - MI)] / MI$ .
8. 1 MI = Minimum Increment =  $[V(R_H) - V(R_L)] / 99$ .
9. Typical values are for  $T_A = +25^\circ C$  and nominal supply voltage.
10. This parameter is not 100% tested.
11. Ratiometric temperature coefficient =  $(V(R_{W(T1(n))}) - V(R_{W(T2(n))})) / [V(R_{W(T1(n))}) - V(R_{W(T1(n))}) \times 10^6]$ , with T1 and T2 being 2 temperatures, and n from 0 to 99.
12. Measured with wiper at tap position 99,  $R_L$  grounded, using test circuit.
13. Parameters with MIN and/or MAX limits are 100% tested at  $+25^\circ C$ , unless otherwise specified. Temperature limits established by characterization and are not production tested.

## Power-up and Down Requirements

The recommended power-up sequence is to apply  $V_{CC}/V_{SS}$  first, then the potentiometer voltages. During power-up, the data sheet parameters for the DCP do not fully apply until 1ms after  $V_{CC}$  reaches its final value. The  $V_{CC}$  ramp spec is always in effect. In order to prevent unwanted tap position changes, or an inadvertent store, bring the  $\overline{CS}$  and  $\overline{INC}$  high before or concurrently with the  $V_{CC}$  pin on power-up.

## AC Timing



## Typical Performance Characteristic



FIGURE 2. TYPICAL TOTAL RESISTANCE TEMPERATURE COEFFICIENT

## Pin Descriptions

### $R_H$ and $R_L$

The high ( $R_H$ ) and low ( $R_L$ ) terminals of the X9317 are equivalent to the fixed terminals of a mechanical potentiometer. The terminology of  $R_L$  and  $R_H$  references the relative position of the terminal in relation to wiper movement direction selected by the  $U/\bar{D}$  input and not the voltage potential on the terminal.

### $R_W$

$R_W$  is the wiper terminal and is equivalent to the movable terminal of a mechanical potentiometer. The position of the wiper within the array is determined by the control inputs. The wiper terminal series resistance is typically 200 $\Omega$ .

### Up/Down ( $U/\bar{D}$ )

The  $U/\bar{D}$  input controls the direction of the wiper movement and whether the counter is incremented or decremented.

### Increment ( $\bar{INC}$ )

The  $\bar{INC}$  input is negative-edge triggered. Toggling  $\bar{INC}$  will move the wiper and either increment or decrement the counter in the direction indicated by the logic level on the  $U/\bar{D}$  input.

### Chip Select ( $\bar{CS}$ )

The device is selected when the  $\bar{CS}$  input is LOW. The current counter value is stored in nonvolatile memory when  $\bar{CS}$  is returned HIGH while the  $\bar{INC}$  input is also HIGH. After the store operation is complete, the X9317 will be placed in the low power standby mode until the device is selected once again.

## Principles of Operation

There are three sections of the X9317: the control section, the nonvolatile memory, and the resistor array. The control section operates just like an up/down counter. The output of this counter is decoded to turn on a single electronic switch connecting a point on the resistor array to the wiper output. The contents of the counter can be stored in nonvolatile memory and retained for future use. The resistor array is comprised of 99 individual resistors connected in series. Electronic switches at either end of the array and between each resistor provide an electrical connection to the wiper pin,  $R_W$ .

The wiper acts like its mechanical equivalent and does not move beyond the first or last position. That is, the counter does not wrap around when clocked to either extreme.

The electronic switches on the device operate in a “make before break” mode when the wiper changes tap positions. If the wiper is moved several positions, multiple taps are connected to the wiper for  $t_{IW}$  ( $\bar{INC}$  to  $V_W$  change). The  $R_{TOTAL}$  value for the device can temporarily be reduced by a significant amount if the wiper is moved several positions.

When the device is powered-down, the last wiper position stored will be maintained in the nonvolatile memory. When power is restored, the contents of the memory are recalled and the wiper is set to the value last stored.

## Instructions and Programming

The  $\bar{INC}$ ,  $U/\bar{D}$  and  $\bar{CS}$  inputs control the movement of the wiper along the resistor array. With  $\bar{CS}$  set LOW, the device is selected and enabled to respond to the  $U/\bar{D}$  and  $\bar{INC}$  inputs. HIGH-to-LOW transitions on  $\bar{INC}$  will increment or decrement (depending on the state of the  $U/\bar{D}$  input) a 7-bit counter. The output of this counter is decoded to select one of one hundred wiper positions along the resistive array.







The value of the counter is stored in nonvolatile memory whenever  $\bar{CS}$  transitions HIGH while the  $\bar{INC}$  input is also HIGH.

The system may select the X9317, move the wiper and deselect the device without having to store the latest wiper position in nonvolatile memory. After the wiper movement is performed as previously described and once the new position is reached, the system must keep  $\bar{INC}$  LOW while taking  $\bar{CS}$  HIGH. The new wiper position will be maintained until changed by the system or until a power-up/down cycle recalls the previously stored data.

This procedure allows the system to always power-up to a preset value stored in nonvolatile memory; then during system operation minor adjustments could be made. The adjustments might be based on user preference, system parameter changes due to temperature drift, etc.

The state of  $U/\bar{D}$  may be changed while  $\bar{CS}$  remains LOW. This allows the host system to enable the device and then move the wiper up and down until the proper trim is attained.

## Mode Selection

$\bar{CS}$	$\bar{INC}$	$U/\bar{D}$	MODE
L		H	Wiper up
L		L	Wiper down
	H	X	Store wiper position to nonvolatile memory
H	X	X	Standby
	L	X	No store, return to standby
	L	H	Wiper up (not recommended)
	L	L	Wiper down (not recommended)

## Applications Information

Electronic digitally controlled (XDCP) potentiometers provide three powerful application advantages:

1. The variability and reliability of a solid-state potentiometer,
2. The flexibility of computer-based digital controls, and
3. The retentivity of nonvolatile memory used for the storage of multiple potentiometer settings or data.



## Basic Configurations of Electronic Potentiometers



FIGURE 3. THREE TERMINAL POTENTIOMETER; VARIABLE VOLTAGE DIVIDER



FIGURE 4. TWO TERMINAL VARIABLE RESISTOR; VARIABLE CURRENT

## Basic Circuits



FIGURE 5. BUFFERED REFERENCE VOLTAGE



FIGURE 6. CASCADING TECHNIQUES



FIGURE 7. SINGLE SUPPLY INVERTING AMPLIFIER



FIGURE 8. VOLTAGE REGULATOR

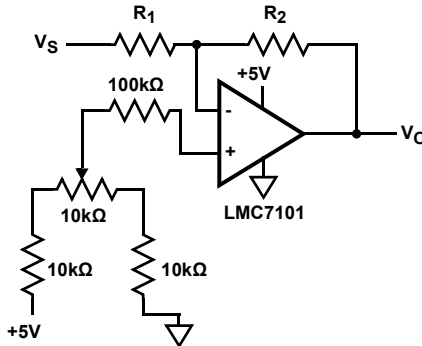

FIGURE 9. OFFSET VOLTAGE ADJUSTMENT



FIGURE 10. COMPARATOR WITH HYSTERESIS

---

## Revision History

The revision history provided is for informational purposes only and is believed to be accurate, but not warranted. Please go to the web to make sure that you have the latest revision.

DATE	REVISION	CHANGE
Dec 17, 2018	FN8183.10	Updated ordering information table by removing EOL parts. Removed About Intersil section. Updated disclaimer.
Nov 4, 2014	FN8183.9	Added Revision History Converted to New Template and added new Intersil Standards. Updated Ordering Information to show all U parts in column for Rtotal (k $\Omega$ ) to show 50 as the value. Added thermal information (Tja and Tjc).

# Package Outline Drawings

For the most recent package outline drawing, see [M8.118](#).

## M8.118

8 LEAD MINI SMALL OUTLINE PLASTIC PACKAGE

Rev 4, 7/11



**NOTES:**

1. Dimensions are in millimeters.
2. Dimensioning and tolerancing conform to JEDEC MO-187-AA and AMSEY14.5m-1994.
3. Plastic or metal protrusions of 0.15mm max per side are not included.
4. Plastic interlead protrusions of 0.15mm max per side are not included.
5. Dimensions are measured at Datum Plane "H".
6. Dimensions in ( ) are for reference only.

**M8.173**

**8 LEAD THIN SHRINK SMALL OUTLINE PACKAGE (TSSOP)**

Rev 2, 01/10

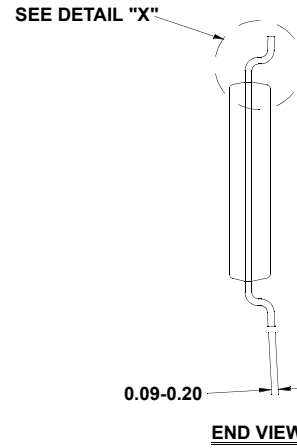

**NOTES:**

1. Dimensions are in millimeters.  
Dimensions in ( ) for Reference Only.
2. Dimension does not include mold flash, protrusions or gate burrs. Mold flash, protrusions or gate burrs shall not exceed 0.15 per side.
3. Dimension does not include interlead flash or protrusion. Interlead flash or protrusion shall not exceed 0.15 per side.
4. Dimensions are measured at datum plane H.
5. Dimensioning and tolerancing per ASME Y14.5M-1994.
6. Dimension on lead width does not include dambar protrusion. Allowable protrusion shall be 0.08 mm total in excess of dimension at maximum material condition. Minimum space between protrusion and adjacent lead is 0.07mm.
7. Conforms to JEDEC MO-153, variation AC. Issue E

**M8.15E**

**8 LEAD NARROW BODY SMALL OUTLINE PLASTIC PACKAGE**

Rev 0, 08/09



NOTES:

1. Dimensions are in millimeters.  
Dimensions in ( ) for Reference Only.
2. Dimensioning and tolerancing conform to AMSE Y14.5m-1994.
3. Unless otherwise specified, tolerance : Decimal ± 0.05
4. Dimension does not include interlead flash or protrusions.  
Interlead flash or protrusions shall not exceed 0.25mm per side.
5. The pin #1 identifier may be either a mold or mark feature.
6. Reference to JEDEC MS-012.

## Notice

1. Descriptions of circuits, software and other related information in this document are provided only to illustrate the operation of semiconductor products and application examples. You are fully responsible for the incorporation or any other use of the circuits, software, and information in the design of your product or system. Renesas Electronics disclaims any and all liability for any losses and damages incurred by you or third parties arising from the use of these circuits, software, or information.
2. Renesas Electronics hereby expressly disclaims any warranties against and liability for infringement or any other claims involving patents, copyrights, or other intellectual property rights of third parties, by or arising from the use of Renesas Electronics products or technical information described in this document, including but not limited to, the product data, drawings, charts, programs, algorithms, and application examples.
3. No license, express, implied or otherwise, is granted hereby under any patents, copyrights or other intellectual property rights of Renesas Electronics or others.
4. You shall not alter, modify, copy, or reverse engineer any Renesas Electronics product, whether in whole or in part. Renesas Electronics disclaims any and all liability for any losses or damages incurred by you or third parties arising from such alteration, modification, copying or reverse engineering.
5. Renesas Electronics products are classified according to the following two quality grades: "Standard" and "High Quality". The intended applications for each Renesas Electronics product depends on the product's quality grade, as indicated below.  
"Standard": Computers; office equipment; communications equipment; test and measurement equipment; audio and visual equipment; home electronic appliances; machine tools; personal electronic equipment; industrial robots; etc.  
"High Quality": Transportation equipment (automobiles, trains, ships, etc.); traffic control (traffic lights); large-scale communication equipment; key financial terminal systems; safety control equipment; etc.  
Unless expressly designated as a high reliability product or a product for harsh environments in a Renesas Electronics data sheet or other Renesas Electronics document, Renesas Electronics products are not intended or authorized for use in products or systems that may pose a direct threat to human life or bodily injury (artificial life support devices or systems; surgical implantations; etc.), or may cause serious property damage (space system; undersea repeaters; nuclear power control systems; aircraft control systems; key plant systems; military equipment; etc.). Renesas Electronics disclaims any and all liability for any damages or losses incurred by you or any third parties arising from the use of any Renesas Electronics product that is inconsistent with any Renesas Electronics data sheet, user's manual or other Renesas Electronics document.
6. When using Renesas Electronics products, refer to the latest product information (data sheets, user's manuals, application notes, "General Notes for Handling and Using Semiconductor Devices" in the reliability handbook, etc.), and ensure that usage conditions are within the ranges specified by Renesas Electronics with respect to maximum ratings, operating power supply voltage range, heat dissipation characteristics, installation, etc. Renesas Electronics disclaims any and all liability for any malfunctions, failure or accident arising out of the use of Renesas Electronics products outside of such specified ranges.
7. Although Renesas Electronics endeavors to improve the quality and reliability of Renesas Electronics products, semiconductor products have specific characteristics, such as the occurrence of failure at a certain rate and malfunctions under certain use conditions. Unless designated as a high reliability product or a product for harsh environments in a Renesas Electronics data sheet or other Renesas Electronics document, Renesas Electronics products are not subject to radiation resistance design. You are responsible for implementing safety measures to guard against the possibility of bodily injury, injury or damage caused by fire, and/or danger to the public in the event of a failure or malfunction of Renesas Electronics products, such as safety design for hardware and software, including but not limited to redundancy, fire control and malfunction prevention, appropriate treatment for aging degradation or any other appropriate measures. Because the evaluation of microcomputer software alone is very difficult and impractical, you are responsible for evaluating the safety of the final products or systems manufactured by you.
8. Please contact a Renesas Electronics sales office for details as to environmental matters such as the environmental compatibility of each Renesas Electronics product. You are responsible for carefully and sufficiently investigating applicable laws and regulations that regulate the inclusion or use of controlled substances, including without limitation, the EU RoHS Directive, and using Renesas Electronics products in compliance with all these applicable laws and regulations. Renesas Electronics disclaims any and all liability for damages or losses occurring as a result of your noncompliance with applicable laws and regulations.
9. Renesas Electronics products and technologies shall not be used for or incorporated into any products or systems whose manufacture, use, or sale is prohibited under any applicable domestic or foreign laws or regulations. You shall comply with any applicable export control laws and regulations promulgated and administered by the governments of any countries asserting jurisdiction over the parties or transactions.
10. It is the responsibility of the buyer or distributor of Renesas Electronics products, or any other party who distributes, disposes of, or otherwise sells or transfers the product to a third party, to notify such third party in advance of the contents and conditions set forth in this document.
11. This document shall not be reprinted, reproduced or duplicated in any form, in whole or in part, without prior written consent of Renesas Electronics.
12. Please contact a Renesas Electronics sales office if you have any questions regarding the information contained in this document or Renesas Electronics products.

(Note 1) "Renesas Electronics" as used in this document means Renesas Electronics Corporation and also includes its directly or indirectly controlled subsidiaries.

(Note 2) "Renesas Electronics product(s)" means any product developed or manufactured by or for Renesas Electronics.

(Rev.4.0-1 November 2017)



### SALES OFFICES

Renesas Electronics Corporation

<http://www.renesas.com>

Refer to "<http://www.renesas.com>" for the latest and detailed information.

#### Renesas Electronics Corporation

TOYOSU FORESIA, 3-2-24 Toyosu, Koto-ku, Tokyo 135-0061, Japan

#### Renesas Electronics America Inc.

1001 Murphy Ranch Road, Milpitas, CA 95035, U.S.A.  
Tel: +1-408-432-8888, Fax: +1-408-434-5351

#### Renesas Electronics Canada Limited

9251 Yonge Street, Suite 8309 Richmond Hill, Ontario Canada L4C 9T3  
Tel: +1-905-237-2004

#### Renesas Electronics Europe Limited

Dukes Meadow, Millboard Road, Bourne End, Buckinghamshire, SL8 5FH, U.K  
Tel: +44-1628-651-700

#### Renesas Electronics Europe GmbH

Arcadiastrasse 10, 40472 Düsseldorf, Germany  
Tel: +49-211-6503-0, Fax: +49-211-6503-1327

#### Renesas Electronics (China) Co., Ltd.

Room 1709 Quantum Plaza, No.27 ZhichunLu, Haidian District, Beijing, 100191 P. R. China  
Tel: +86-10-8235-1155, Fax: +86-10-8235-7679

#### Renesas Electronics (Shanghai) Co., Ltd.

Unit 301, Tower A, Central Towers, 555 Langao Road, Putuo District, Shanghai, 200333 P. R. China  
Tel: +86-21-2226-0888, Fax: +86-21-2226-0999

#### Renesas Electronics Hong Kong Limited

Unit 1601-1611, 16/F., Tower 2, Grand Century Place, 193 Prince Edward Road West, Mongkok, Kowloon, Hong Kong  
Tel: +852-2265-6688, Fax: +852 2886-9022

#### Renesas Electronics Taiwan Co., Ltd.

13F, No. 363, Fu Shing North Road, Taipei 10543, Taiwan  
Tel: +886-2-8175-9600, Fax: +886 2-8175-9670

#### Renesas Electronics Singapore Pte. Ltd.

80 Bendemeer Road, Unit #06-02 Hyflux Innovation Centre, Singapore 339949  
Tel: +65-6213-0200, Fax: +65-6213-0300

#### Renesas Electronics Malaysia Sdn.Bhd.

Unit 1207, Block B, Menara Amcorp, Amcorp Trade Centre, No. 18, Jln Persiaran Barat, 46050 Petaling Jaya, Selangor Darul Ehsan, Malaysia  
Tel: +60-3-7955-9390, Fax: +60-3-7955-9510

#### Renesas Electronics India Pvt. Ltd.

No.777C, 100 Feet Road, HAL 2nd Stage, Indiranagar, Bangalore 560 038, India  
Tel: +91-80-67208700, Fax: +91-80-67208777

#### Renesas Electronics Korea Co., Ltd.

17F, KAMCO Yangjae Tower, 262, Gangnam-daero, Gangnam-gu, Seoul, 06265 Korea  
Tel: +82-2-558-3737, Fax: +82-2-558-5338