

UNIQUE ID click™

2. Soldering the headers

Before using your click™ board, make sure to solder 1x8 male headers to both left and right side of the board. Two 1x8 male headers are included with the board in the package.

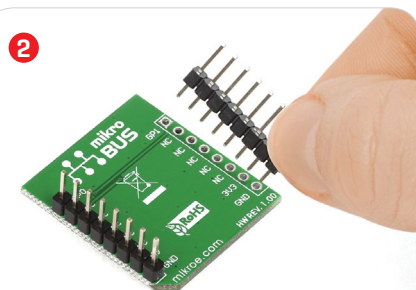
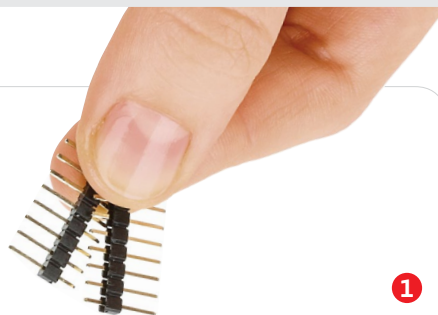

Turn the board upside down so that the bottom side is facing you upwards. Place shorter pins of the header into the appropriate soldering pads.

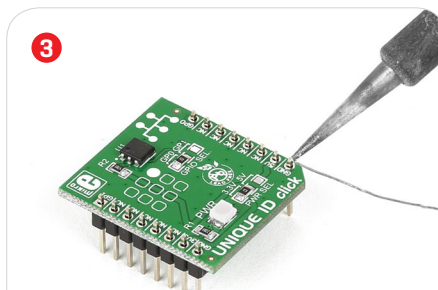

Turn the board upward again. Make sure to align the headers so that they are perpendicular to the board, then solder the pins carefully.

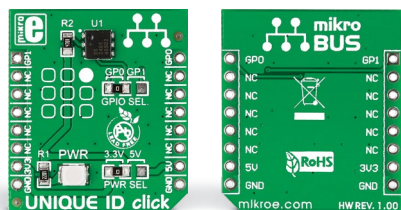

1. Introduction

Unique ID click™ carries **DS2401**, an enhanced **silicon serial number IC**. It's a low cost solution for providing a unique registration number to your design. The chip uses **1-Wire** communications for interfacing with the target board microcontroller, either through a GP1 or GPO pin [here in place of the default AN and PWM mikroBUS™ pins]. The board is designed to use either a 3.3V or 5V power supply.

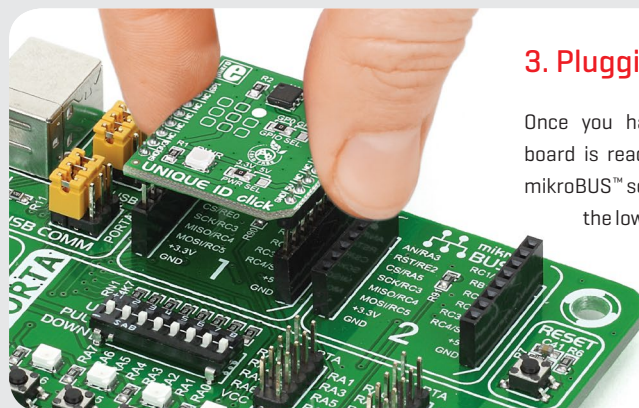

3. Plugging the board in

Once you have soldered the headers your board is ready to be placed into the desired mikroBUS™ socket. Make sure to align the cut in the lower-right part of the board with the markings on the silkscreen at the mikroBUS™ socket. If all the pins are aligned correctly, push the board all the way into the socket.

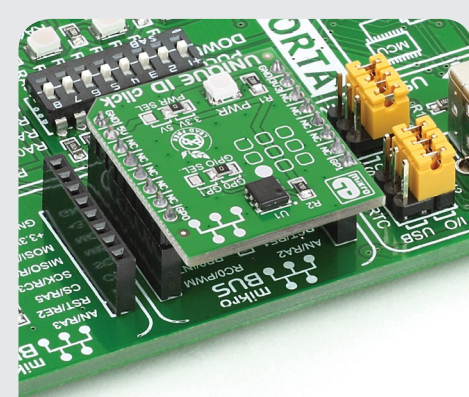

4. Essential features

The DS2401 IC consists of a **factory-lasered 64-bit ROM** that includes a **unique 48-bit serial number, an 8-bit CRC, and an 8-bit family code**. The data is transferred serially through the 1-Wire interface. The unique number can then be used as a PCB identification, to establish a network node ID, for equipment registration and similar purposes. Additionally, the multidrop capability of DS2401 enables multiple devices to reside on a single data line.

click™
BOARD
www.mikroe.com



UNIQUE ID click™ manual
ver 1.00



5. Schematic

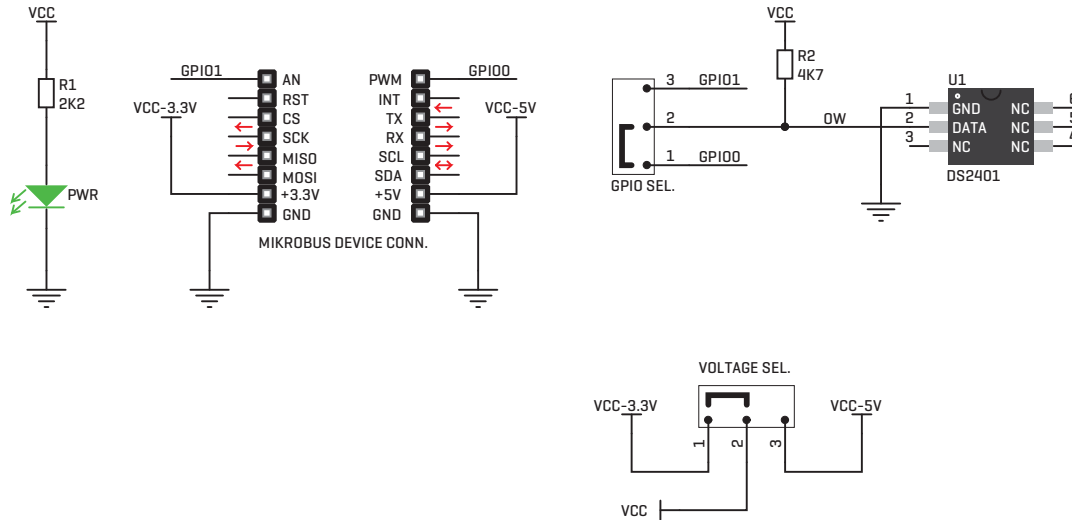

6. Dimensions

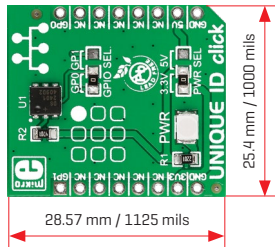

	mm	mils
LENGTH	28.57	1125
WIDTH	25.4	1000
HEIGHT*	3.5	135.8

* without headers

7. SMD jumper

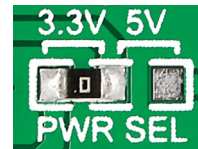

The board features a GPIO SEL. jumper [zero ohm resistor] that allows you to choose between two available pins for the 1-Wire interface.

8. Code examples

Once you have done all the necessary preparations, it's time to get your click™ board up and running. We have provided examples for mikroC™, mikroBasic™ and mikroPascal™ compilers on our **Libstock** website. Just download them and you are ready to start.



9. Support

MikroElektronika offers **free tech support** [www.mikroe.com/support] until the end of the product's lifetime, so if something goes wrong, we're ready and willing to help!



10. Disclaimer

MikroElektronika assumes no responsibility or liability for any errors or inaccuracies that may appear in the present document. Specification and information contained in the present schematic are subject to change at any time without notice.

Copyright © 2015 MikroElektronika.
All rights reserved.