

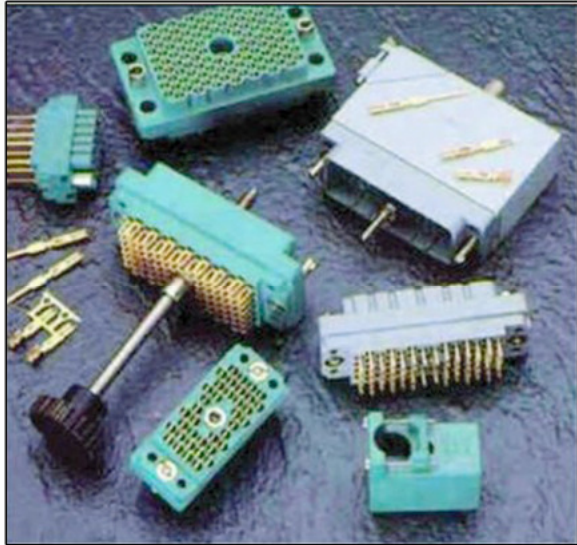

SERIES 516



FEATURES

UL Recognized.

.150 (3.81) Contact Spacing x .150 (3.81) Row Spacing with Staggered Gold

Plug & Receptacle in 20, 38, 56, 90 or 120 Contact Sizes

Edacon Hermaphroditic Contact Mating Design

Contact Termination Options include Crimp, P.C. Tail, Wire Hole and Wire Wrap

Mating and Unmating Simplified with use of Actuating Screws

Optional Covers with Side or Top Entry Cable Clamp in Plastic or Metal Material Available for all Connector Sizes

Versatile Metal Cover Design permits Assembly or Disassembly After Cabling is Complete plus Cable Entry Style Flexibility

Actuating Screws, Locknuts, Polarizing Hardware, Covers and Contacts Suitable for either Plug or Receptacle

Polarizing Hardware Adjustable for 288 Mating Combinations

Tools Available for Contact Installation, Removal and Crimping and Polarizing Changes

SPECIFICATIONS

Insulator Material: Thermoplastic Polyester or Diallyl Phthalate, UL 94V-0, Colour: Green, or Polycarbonate, Colour: Grey

Contact Material: Phosphor Bronze Alloy CA-510

Contact Plating: Gold over Nickel

Cover Material: Poly Carbonate, Colour Green or Die-Cast Zinc, finished with Grey Enamel Paint

Current Rating: 8.5 Amperes

Contact Resistance: 10 Milliohms Maximum

Dielectric Withstanding Voltage: 2000 V AC rms at Sea Level

Example Part Number 516 - 038 - 500 - 2 1 2

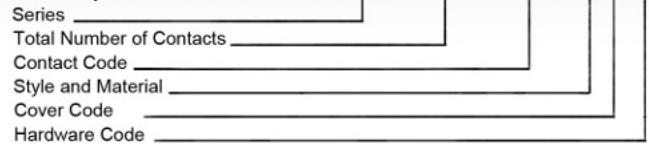

Series 516

Total Number of Contacts 020, 038, 056, 090 or 120

| Contact Code | Description & Tail Size | Tail Length "G" |
|--------------|-------------------------------------|-----------------|
| 000 | No Contacts Assembled | --- |
| 500 | Wire Hole .110 x .024 (2.79 x 0.61) | .245 (6.22) |
| 520 | P.C. Tail .025 x .024 (0.64 x 0.61) | .215 (5.46) |
| 540 | Wire Wrap .050 x 024 (1.27 x 0.61) | .600 (15.24) |
| 541 | Wire Wrap .026 x .024 (0.66 x 0.61) | .620 (15.75) |
| 542 | Wire Wrap .050 x .024 (1.27 x .061) | .790 (20.07) |

| Style & Material | Style | Insulator Material |
|------------------|------------|-------------------------|
| 1 | Plug | Green Diallyl Phthalate |
| 2 | Receptacle | Green Diallyl Phthalate |
| 3 | Plug | Grey Polycarbonate |
| 4 | Receptacle | Grey Polycarbonate |
| 5 | Plug | Green Polyester |
| 6 | Receptacle | Green Polyester |

| Cover Code | Description |
|------------|--|
| 0 | No Cover Assembled |
| 1 | Plastic Cover, Top Entry Standard Clamp |
| 2 | Plastic Cover, Side Entry Standard Clamp |
| 3 | Plastic Cover, Top Entry Large Clamp |
| 4 | Plastic Cover, Side Entry Large Clamp |
| 5 | Metal Cover, Side Entry |
| 6 | Metal Cover, Top Entry |

| Hardware Code | Description |
|---------------|---|
| 0 | No Hardware Assembled |
| 1 | Actuating Screw and Polarizing Hardware |
| 2 | Locknut and Polarizing Hardware |
| 5 | Actuating Screw with No Polarizing Hardware |
| 6 | Locknut with No Polarizing Hardware |

Ordering Code Notes

Crimp contacts are also available for the 516 series connectors. Contacts be ordered separately for pre-wired or select position assembly.

| Part Number | Description | Silhouette |
|-------------|--------------------------------|------------|
| 516-290-500 | Wire Hole | |
| 516-290-520 | P.C. Tail | |
| 516-290-540 | Wire Wrap | |
| 516-290-541 | Wire Wrap | |
| 516-290-542 | Wire Wrap | |
| 516-290-590 | Crimp - Loose | |
| 516-290-591 | Crimp - 1800 Contacts per reel | |

Continued on next page

Insulation Resistance: 5000 Milliohms Minimum

Operating Temperature: -65 to +125 Degrees C

Insertion and Withdrawal Force: 2 to 16 oz 0 (0.56 to 4.45 N) per Contact Position

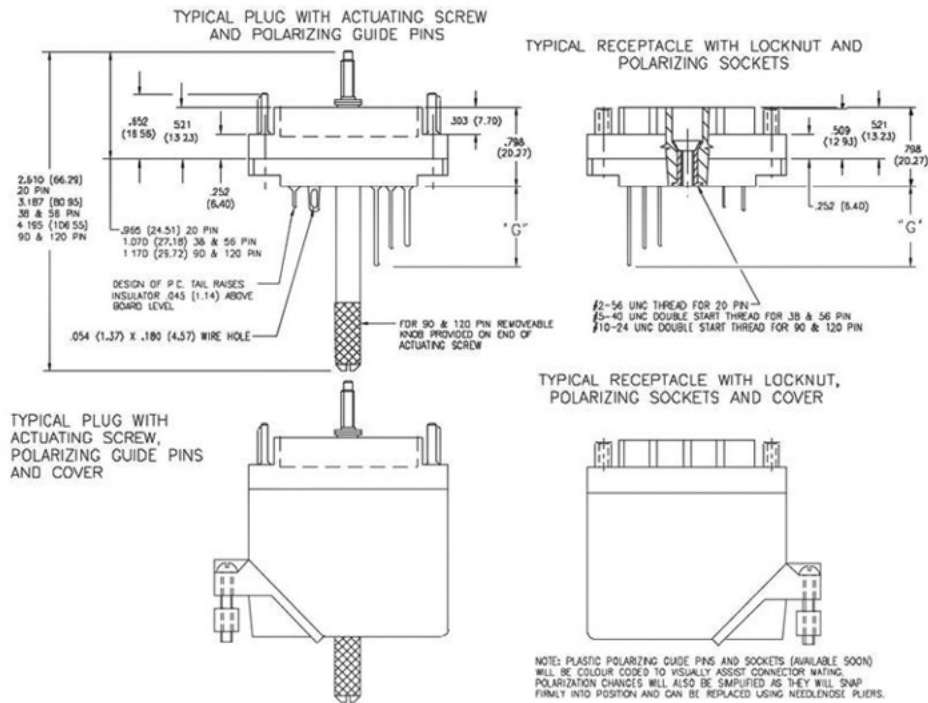

ORDERING CODE NOTES (Continued)

- 2) For contact installation, removal and crimping tools, refer to page 72.
- 3) Grey polycarbonate insulator material is not available for the 120 pin size connector.
- 4) The 20 pin connector cover will not accept the length of the wire wrap contacts.
- 5) Plastic covers with large clamps are only available for the 38 and 56 pin size connectors.
- 6) Metal covers with side entry may be converted to top entry by removing side plate and changing clamp orientation.
- 7) Covers may be ordered separately. Refer to page 88.
- 8) Insulator design prevents improper mating of individual plug and receptacle. Polarizing hardware enables specific plug and receptacle mating combinations.

CRIMP CHARACTERISTICS

- Contacts and Crimp Tools Accommodate from 28 AWG to 18 AWG, Solid or Stranded Conductor Diameters from .012 (0.30) to .049 (1.25) and an Insulation Diameter up to .074 (1.88)
- Multiple Smaller Gauge Wires may be Crimped Together
- Crimp Resistance from 0.5 Milliohms (18 AWG) to 1.5 Milliohms (28AWG)

POLARIZING CODES

- Polarizing Hardware Changes allow 288 Mating Combinations
- Standard Code Supplied for Plugs PG1G1, for Receptacles RS1S1. Connectors with Special Polarizing Codes Available upon Request

• Example Polarizing Code:

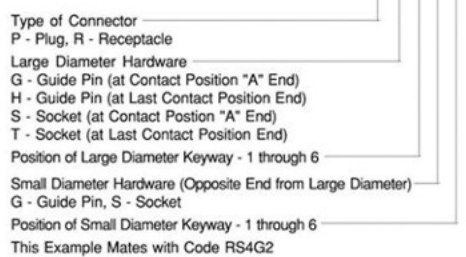

• Crimp Tensile Strength for Wire Sizes

| | |
|-------------------------|-------------------------|
| 18 AWG - 40 lbs (178 N) | 20 AWG - 25 lbs (111 N) |
| 22 AWG - 15 lbs (67 N) | 24 AWG - 10 lbs (44 N) |
| 26 AWG - 5 lbs (22 N) | 28 AWG - 3 lbs (13 N) |

CONNECTOR MATING FACE VIEWS
 DIMENSIONS INDICATED FOR EACH SIZE APPLY TO BOTH PLUG AND RECEPTACLE

20 PIN PLUG

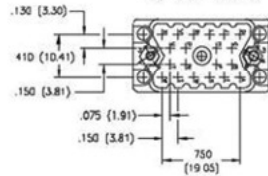

20 PIN RECEPTACLE

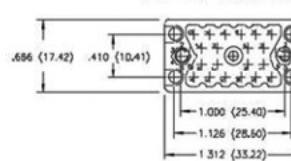

38 PIN PLUG

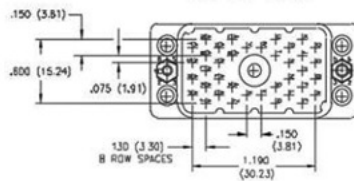

38 PIN RECEPTACLE

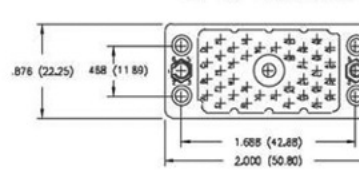

56 PIN PLUG

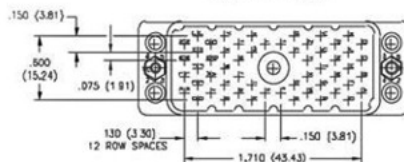

56 PIN RECEPTACLE

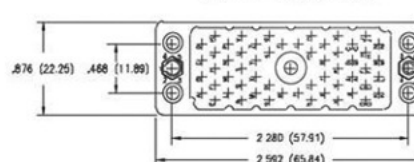

90 PIN PLUG

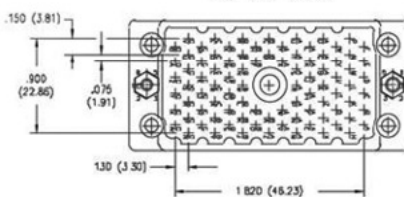

90 PIN RECEPTACLE

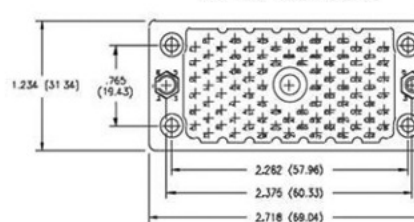

120 PIN PLUG

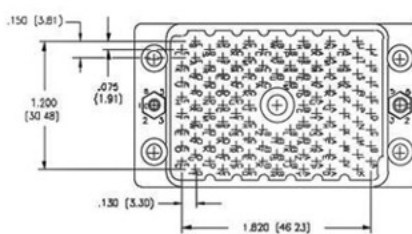

120 PIN RECEPTACLE

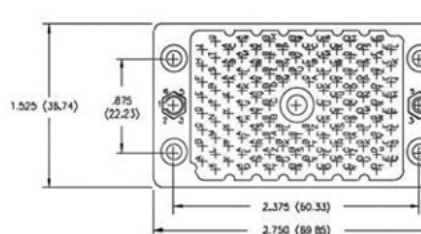



SERIES 516

Example Part Number **516 - 230 - 5 56**

Series _____
 Cover Identification Code _____
 Cover Type _____
 Cover Size _____

Series 516

Cover Identification Code 230

| Cover Type ^{1,2} | Description |
|---------------------------|--|
| 1 | Plastic Cover, Side Entry Standard Clamp |
| 2 | Plastic Cover, Top Entry Standard Clamp |
| 3 | Plastic Cover, Side Entry Large Clamp |
| 4 | Plastic Cover, Top Entry Large Clamp |
| 5 | Metal Cover, Side Entry |
| 6 | Metal Cover, Top Entry |
| 7 | Metal Cover, Large Clamp |

| Cover Size | Fits Connector |
|------------|---|
| 12 | 516 Series 120 Pin |
| 20 | 516 Series 20 Pin and 519 Series 14 Pin |
| 38 | 516 Series 38 Pin and 519 Series 36 Pin |
| 56 | 516 Series 56 Pin |
| 90 | 516 Series 90 Pin |

Ordering Code Notes

- 1) Plastic covers with large clamps are only available for the 38 and 56 pin size connectors.
- 2) Metal covers with side entry may be converted to top entry by removing side plate and changing clamp orientation.

Features

Available in Metal (Die-Cast Zinc Finished with Grey Enamel Paint) or Plastic (Green Polycarbonate) Material

Covers with Top or Side Entry Cable Clamp.

Orientation of Clamp on Metal Covers may be changed by the Customer

Versatile Metal Cover Design permits Assembly or Disassembly after Cabling is Complete

Screws for Securing Cover to 516 or 519 Series Connectors Supplied

METAL COVERS

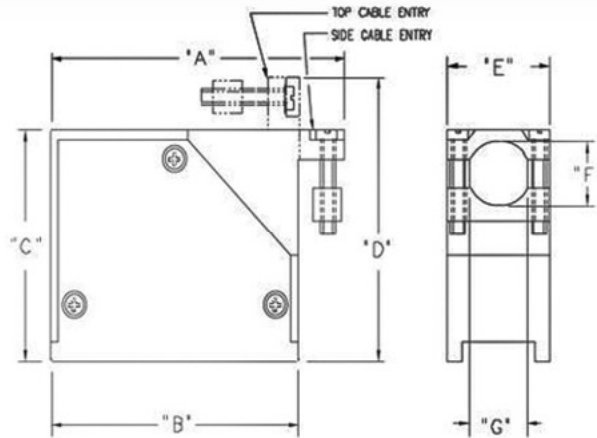

NEW COVER DESIGN (AVAILABLE SOON) WILL ELIMINATE 3 SCREWS FOR SIDE TO SIMPLIFY ASSEMBLY, DISASSEMBLY AND CLAMP ORIENTATION CHANGES

SCREWS FOR SECURING THE COVER TO THE CONNECTOR ARE SUPPLIED BY EDAC.

PLASTIC COVERS

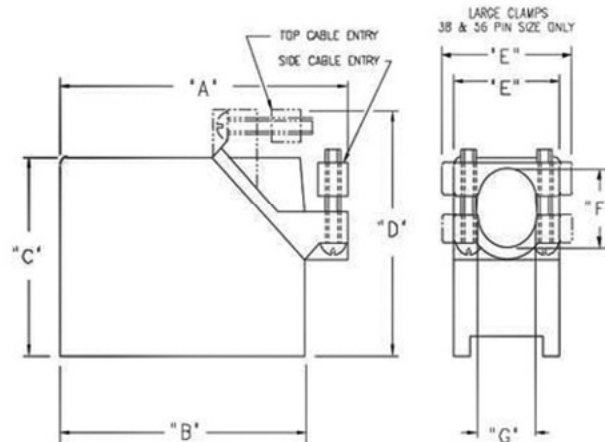

| COVER FOR CONNECTOR | COVER MATERIAL | CLAMP SIZE | "A" | | "B" | | "C" | | "D" | | "E" | | "F" | | "G" | |
|---------------------|----------------|------------|-------|---------|-------|---------|-------|---------|-------|---------|-------|---------|------|---------|-------|---------|
| | | | Inch | (mm) | Inch | (mm) | Inch | (mm) | Inch | (mm) | Inch | (mm) | Inch | (mm) | Inch | (mm) |
| 20 Pin | Plastic | Standard | 1.605 | (40.77) | 1.325 | (33.66) | .906 | (23.01) | 1.190 | (30.23) | .715 | (18.16) | .450 | (11.43) | .450 | (11.43) |
| 20 Pin | Metal | Standard | 1.539 | (39.09) | 1.325 | (33.66) | .906 | (23.01) | 1.120 | (28.45) | .686 | (17.42) | .446 | (11.33) | .490 | (12.45) |
| 38 Pin | Plastic | Standard | 2.460 | (62.48) | 2.010 | (51.05) | 1.530 | (38.86) | 1.985 | (50.42) | .910 | (23.11) | .650 | (16.51) | .500 | (12.70) |
| 38 Pin | Plastic | Large | 2.460 | (62.48) | 2.010 | (51.05) | 1.530 | (38.86) | 1.985 | (50.42) | 1.110 | (28.19) | .650 | (16.51) | .608 | (15.44) |
| 38 Pin | Metal | Standard | 2.206 | (56.03) | 2.006 | (50.95) | 1.566 | (39.78) | 1.766 | (44.86) | .875 | (22.23) | .720 | (18.29) | .575 | (14.61) |
| 56 Pin | Plastic | Standard | 3.052 | (77.52) | 2.602 | (66.09) | 1.530 | (38.86) | 1.985 | (50.42) | .910 | (23.11) | .650 | (16.51) | .500 | (12.70) |
| 56 Pin | Plastic | Large | 3.052 | (77.52) | 2.602 | (66.09) | 1.530 | (38.86) | 1.985 | (50.42) | 1.110 | (28.19) | .650 | (16.51) | .608 | (15.44) |
| 56 Pin | Metal | Standard | 2.802 | (71.17) | 2.602 | (66.09) | 1.566 | (39.78) | 1.766 | (44.86) | .875 | (22.23) | .720 | (18.29) | .575 | (14.61) |
| 90 Pin | Plastic | Standard | 3.124 | (79.35) | 2.718 | (69.04) | 1.775 | (45.09) | 2.181 | (55.40) | 1.250 | (31.75) | .800 | (20.32) | .800 | (20.32) |
| 90 Pin | Metal | Standard | 3.118 | (79.20) | 2.718 | (69.04) | 1.775 | (45.09) | 2.175 | (55.25) | 1.234 | (31.34) | .880 | (22.35) | .900 | (22.86) |
| 120 Pin | Plastic | Standard | 3.156 | (80.16) | 2.750 | (69.85) | 2.020 | (51.31) | 2.426 | (61.62) | 1.530 | (38.86) | .800 | (20.32) | 1.080 | (27.43) |
| 120 Pin | Metal | Standard | 3.175 | (80.65) | 2.750 | (69.85) | 2.020 | (51.31) | 2.445 | (62.10) | 1.531 | (38.89) | .890 | (22.61) | 1.080 | (27.43) |

RACK AND PANEL CONNECTORS



516 / 519 SERIES CONNECTOR PANEL MOUNTING CUT-OUT

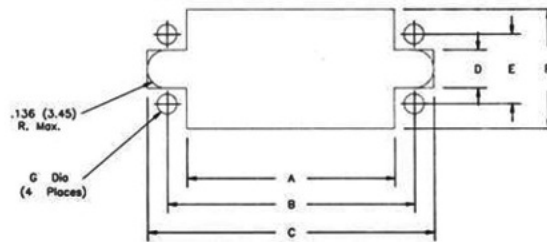

516 SERIES CONNECTOR CUT OUTS

| CONNECTOR SIZE | A | B | C | D | E | F | G Dia |
|----------------|---------------|---------------|---------------|-------------|--------------|---------------|-------------|
| 20 pin | .960 (24.38) | 1.126 (28.6) | 1.270 (32.26) | .260 (6.60) | .410 (10.41) | .640 (16.26) | .104 (2.64) |
| 38 pin | 1.420 (36.07) | 1.688 (42.87) | 1.958 (49.73) | .260 (6.60) | .468 (11.89) | .816 (20.73) | .136 (3.45) |
| 56 pin | 1.940 (49.28) | 2.280 (57.91) | 2.550 (64.77) | .260 (6.60) | .468 (11.89) | .816 (20.73) | .136 (3.45) |
| 90 pin | 2.050 (52.07) | 2.282 (57.96) | 2.675 (67.95) | .300 (7.62) | .765 (19.43) | 1.120 (36.07) | .136 (3.45) |
| 120 pin | 2.050 (52.07) | 2.375 (60.32) | 2.675 (67.95) | .300 (7.62) | .875 (22.22) | 1.420 (36.07) | .156 (3.96) |

519 SERIES CONNECTOR CUT OUTS

| CONNECTOR SIZE | A | B | C | D | E | F | G Dia |
|----------------|---------------|---------------|---------------|-------------|--------------|--------------|-------------|
| 14 pin | .960 (24.38) | 1.126 (28.6) | 1.270 (32.26) | .260 (6.60) | .410 (10.41) | .640 (16.26) | .104 (2.64) |
| 36 pin | 1.420 (36.07) | 1.688 (42.87) | 1.958 (49.73) | .260 (6.60) | .468 (11.89) | .816 (20.73) | .136 (3.45) |

EDAC

SERIES 516

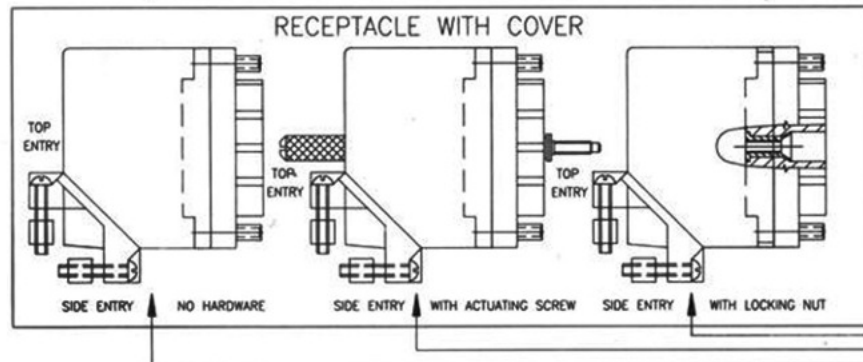
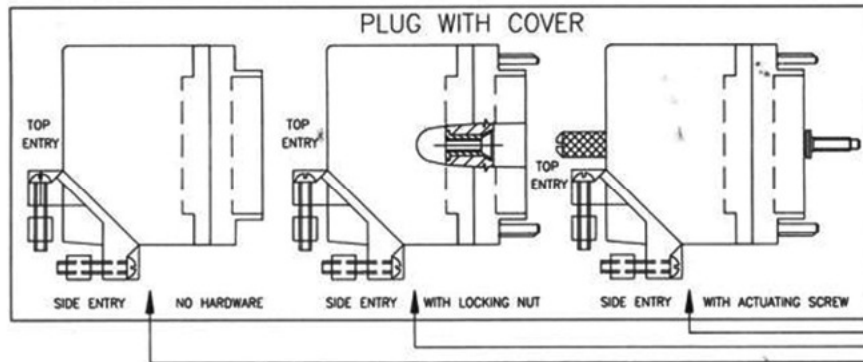
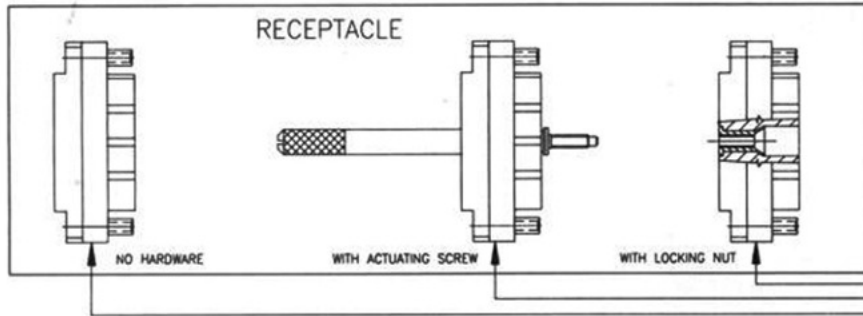
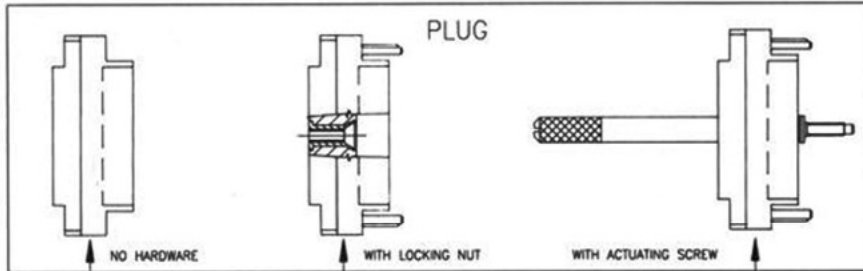

ORDERING CODE

516 056 540 102

SERIES NUMBER OF CONTACTS CONTACT CODE

| DAP CODE | STYLE | DESCRIPTION | POLYCARB CODE |
|----------|--|-----------------|---------------|
| 101 | P L U G | ACTUATING SCREW | 301 |
| 102 | | LOCKING NUT | 302 |
| 100 | | NO HARDWARE | 300 |
| 202 | R E C E P T A C L E | ACTUATING SCREW | 402 |
| 201 | | LOCKING NUT | 401 |
| 200 | | NO HARDWARE | 400 |

POLYCARBONATE CONNECTORS AVAILABLE IN 20,38,56 AND 90 PINS SIZES ONLY

| CODE REC. CLAMP | STYLE | DESCRIPTION | CODE LARGE CLAMP |
|-----------------|------------------------------|--|----------------------------|
| 111 | P L U G | ACTUATING SCREW, TOP ENTRY | 131 |
| 121 | | ACTUATING SCREW, SIDE ENTRY | 141 |
| 151 | | ACTUATING SCREW, METAL COVER | 151 |
| 112 | | LOCKING, NUT TOP ENTRY | 132 |
| 122 | | LOCKING, NUT SIDE ENTRY | 142 |
| 152 | | LOCKING, NUT METAL COVER | 152 |
| 110 | | NO HARDWARE, TOP ENTRY | 152 |
| 120 | | NO HARDWARE, SIDE ENTRY | 130 |
| 150 | | NO HARDWARE METAL COVER | 150 |
| 211 | | R E C E P T A C L E | ACTUATING SCREW, TOP ENTRY |
| 221 | ACTUATING SCREW, SIDE ENTRY | | 241 |
| 251 | ACTUATING SCREW, METAL COVER | | 251 |
| 212 | LOCKING, NUT TOP ENTRY | | 232 |
| 222 | LOCKING, NUT SIDE ENTRY | | 242 |
| 252 | LOCKING, NUT METAL COVER | | 252 |
| 210 | NO HARDWARE, TOP ENTRY | | 230 |
| 220 | NO HARDWARE, SIDE ENTRY | | 240 |
| 250 | NO HARDWARE METAL COVER | | 250 |