

Product Overview

The QPD0030 is a 45 W (P3dB) unmatched discrete GaN on SiC HEMT which operates from DC to 5GHz on a +48 V supply rail. It is ideally suited for base station, radar and communications applications and can support both CW and pulsed mode of operations.

The QPD0030 can be used in Doherty architecture for the final stage of a base station power amplifier for small cell, microcell, and active antenna systems. The QPD0030 can also be used as a driver in a macrocell base station power amplifier.

The device is housed in an industry-standard 4x3 mm surface mount QFN package.

Lead-free and ROHS compliant.



20 Pin 3 x 4 mm QFN Package

Key Features

- Operating Frequency Range: DC to 5 GHz
- Operating Drain Voltage: +48 V
- Maximum Output Power (P_{SAT}): 49.0 W ⁽¹⁾
- Maximum Drain Efficiency: 71.9% ⁽¹⁾
- Efficiency-Tuned P3dB Gain: 22.1 dB ⁽¹⁾
- Surface Mount Plastic Package

Notes:

1. Load pull performance at 2.2 GHz.

Functional Block Diagram

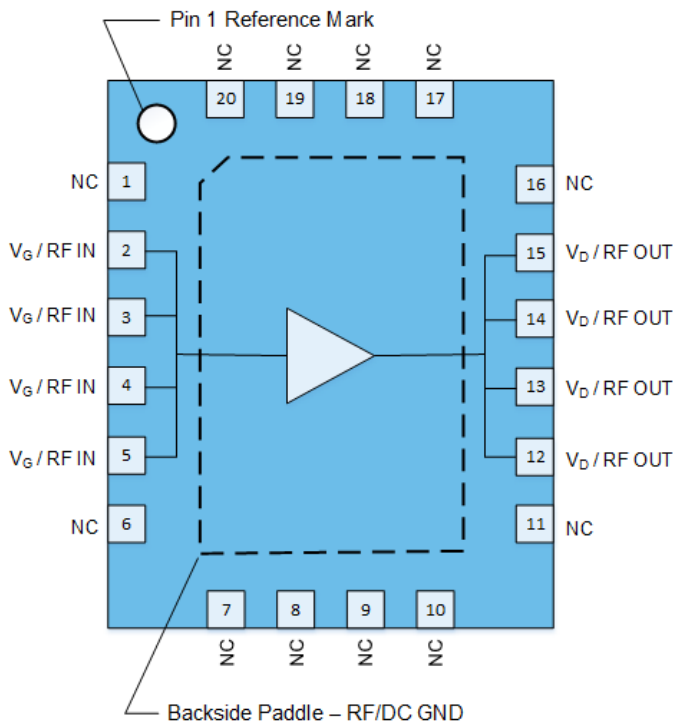

Applications

- W-CDMA / LTE
- Macrocell Base Station Driver
- Small Cell Final Stage
- Active Antenna
- Land Mobile and Military Radio Communications
- Wideband or Narrowband Amplifiers
- General Purpose Applications

Ordering Information

Part Number	Description
QPD0030SR	Short Reel – 100 Pieces
QPD0030TR7	7" Reel – 500 pieces
QPD0030EVB01	1.2 – 1.4 GHz Evaluation Board
QPD0030EVB02	1.8 – 2.2 GHz Evaluation Board

Absolute Maximum Ratings

Parameter	Rating
Breakdown Voltage (V_{BDG})	+165 V
Gate Voltage Range (V_G)	-7 to +2 V
Drain Voltage (V_D)	+55 V
Peak RF Input Power	33 dBm
VSWR Mismatch, P1dB Pulse (20% Duty Cycle, 100 μ s Width), $T = +25^\circ\text{C}$	10:1
Storage Temperature	-65 to +150 $^\circ\text{C}$

Exceeding any one or a combination of the Absolute Maximum Rating conditions may cause permanent damage to the device. Extended application of Absolute Maximum Rating conditions to the device may reduce device reliability.

Recommended Operating Conditions

Parameter	Min	Typ	Max	Unit
Gate Voltage (V_G)		-2.8		V
Drain Voltage (V_D)		+48		V
Quiescent Drain Current (I_{DQ})		85		mA

Electrical specifications are measured at specified test conditions. Specifications are not guaranteed over all recommended operating conditions.

QPD0030EVB01 Electrical Specifications

Parameter	Conditions	Min	Typ	Max	Units
Operational Frequency Range		1200		1400	MHz
Quiescent Drain Current (I_{DQ})			90		mA
Linear Gain	$P_{OUT} = 34$ dBm		19.9		dB
Output Power (P3dB)	3 dB Compression		45.6		dBm
Power-Added Efficiency (%)	3 dB Compression		74.2		%
Gain	3 dB Compression		16.9		dB

Test conditions unless otherwise noted: $V_D = +48$ V, $I_{DQ} = 90$ mA, $T = +25^\circ\text{C}$, Pulse signal (10% Duty Cycle, 100 μ s Width) at 1300 MHz on a Class AB single-ended reference design fixture tuned for 1.2 – 1.4 GHz.

QPD0030EVB02 Electrical Specifications

Parameter	Conditions	Min	Typ	Max	Units
Operational Frequency Range		1800		2200	MHz
Quiescent Drain Current (I_{DQ})			85		mA
Linear Gain	$P_{OUT} = 34$ dBm		20.2		dB
Output Power (P3dB)	3 dB Compression		45.2		dBm
Power-Added Efficiency (%)	3 dB Compression		57.5		%
Gain	3 dB Compression		16.3		dB
Gate Leakage	$V_D = +48$ V, $V_G = -7$ V	-13.9			mA

Test conditions unless otherwise noted: $V_D = +48$ V, $I_{DQ} = 85$ mA, $T = +25^\circ\text{C}$, Pulse signal (10% Duty Cycle, 100 μ s Width) at 2005 MHz on a Class AB single-ended reference design fixture tuned for 1.8 – 2.2 GHz.

Thermal Information

Parameter	Conditions	Values	Units
Thermal Resistance, Peak IR Surface Temperature at Average Power (θ_{JC})	$T_{CASE} = +85^\circ\text{C}$, $T_{CH} = 114^\circ\text{C}$ CW: $P_{DISS} = 9.6$ W, $P_{OUT} = 2.1$ W	3.0	$^\circ\text{C/W}$

Notes:

1. Thermal resistance is measured to package backside.
2. Refer to the following document: [GaN Device Channel Temperature, Thermal Resistance, and Reliability Estimates](#)

QPD0030EVB01 Layout – 1200 – 1400 MHz Reference Design

Note: PCB Material is RO6010, 25 mil thick substrate, 1 oz. copper each side.

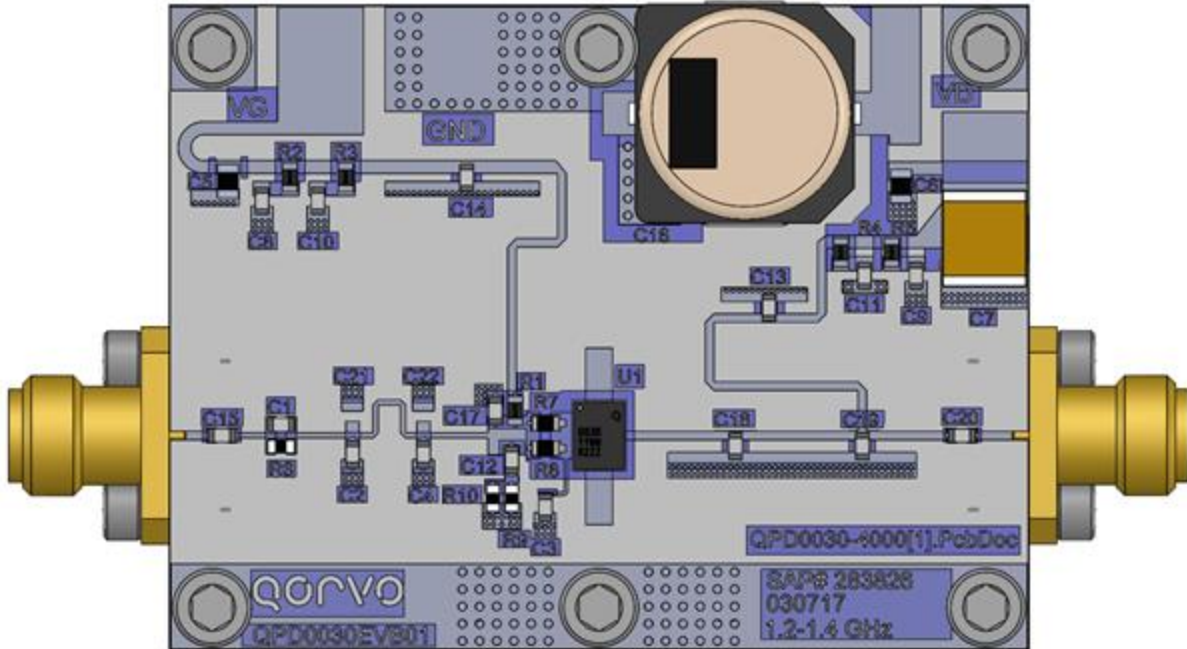

QPD0030EVB01 Bill of Materials

Reference Des.	Value	Description	Manufacturer	Part Number
C1	10 pF	RF NPO 250VDC ± 5% Capacitor	ATC	600S100JT250XT
C2, C3	1.0 pF	RF NPO 250VDC ± 0.05 pF Capacitor	ATC	600S1R0AT250XT
C4	4.7 pF	RF NPO 250VDC ± 0.1 pF Capacitor	ATC	600S4R7BT250XT
C5, C6	0.1uF	X7R 100V 10% 0805 Capacitor	TDK	C2012X7R2A104K
C7	10 uF	X7S 100V 10% 2220 Capacitor	TDK	C5750X7S2A106K230KB
C8, C9	0.1 uF	X7R 100V 10% 0603 Capacitor	Murata	GRM188R72A104KA35D
C10, C11, C12	100 pF	RF C0G 250VDC ± 5% Capacitor	TDK	C1608C0G2E101JT080AA
C13, C14, C15	15 pF	RF NPO 250VDC ± 5% Capacitor	ATC	600S150JT250XT
C16	100 uF	ALUM 100V 20% 12.5mm SQ	BC Components	MAL215099907E3
C17	7.5 pF	RF NPO 250VDC ± 0.1 pF Capacitor	ATC	600S7R5BT250XT
C18	8.2 pF	RF NPO 250VDC ± 0.1 pF Capacitor	ATC	600S8R2BT250XT
C19	3.3 pF	RF NPO 250VDC ± 0.1 pF Capacitor	ATC	600S3R3BT250XT
C20	5.6 pF	RF NPO 250VDC ± 0.1 pF Capacitor	ATC	600S5R6BW250XT
R1, R2, R3, R4, R5	10 Ω	0603 5% Thick Film Resistor	KOA Speer	RK73B1JTDD100J
R6	100 Ω	0603 1% Thick Film Resistor	Panasonic	ERJ-3EKF1000
R7, R8	5.1 Ω	0603 1% Thick Film Resistor	Samsung	RC1608F5R1CS
R9, R10	240 Ω	0603 1% Thick Film Resistor	Samsung	RC1608F241CS

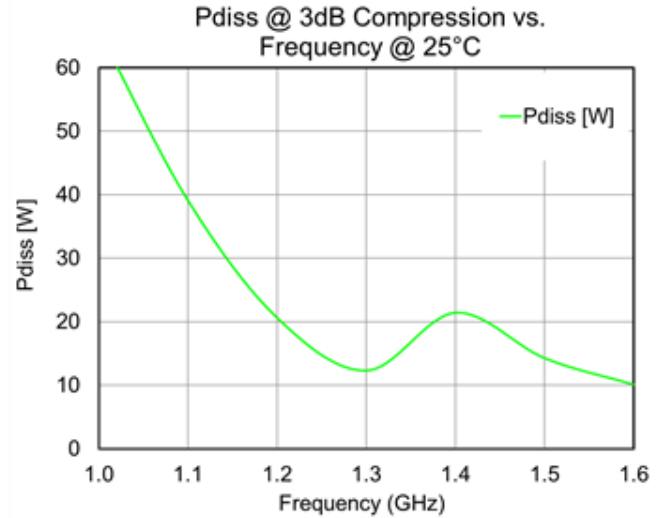
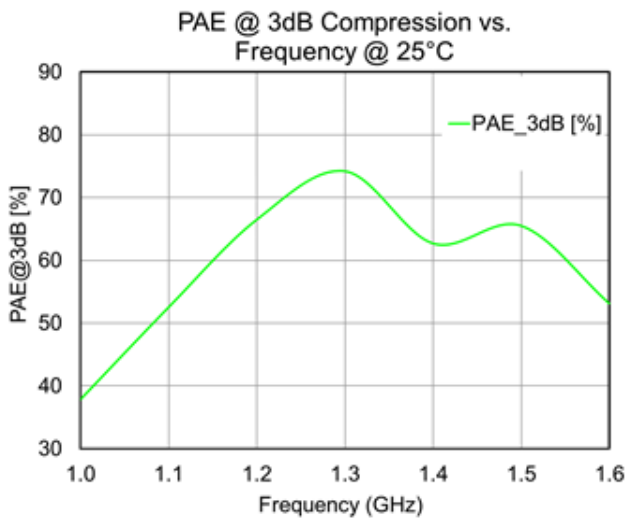
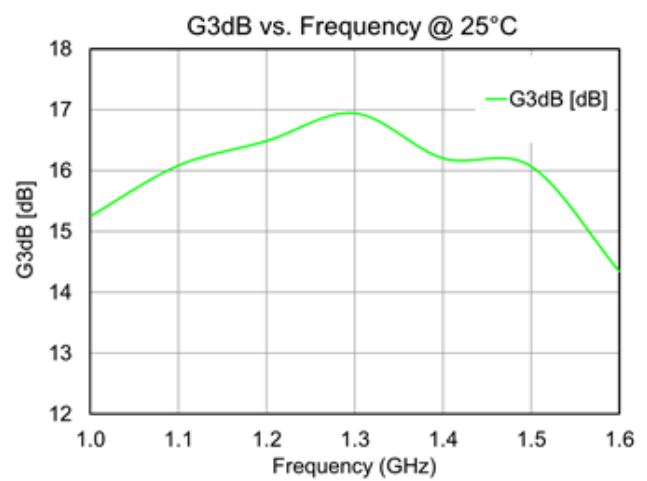
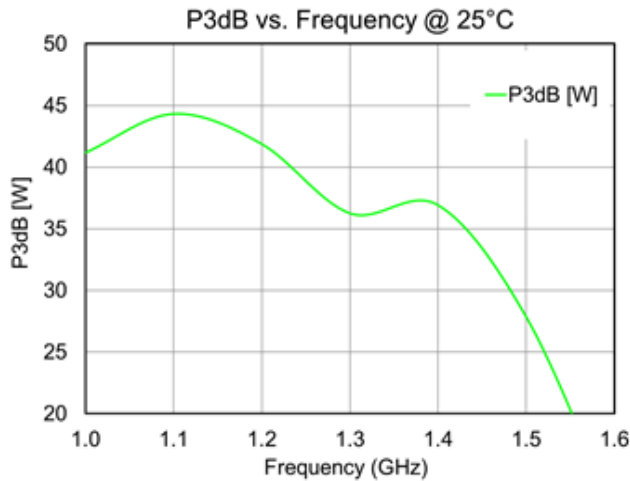
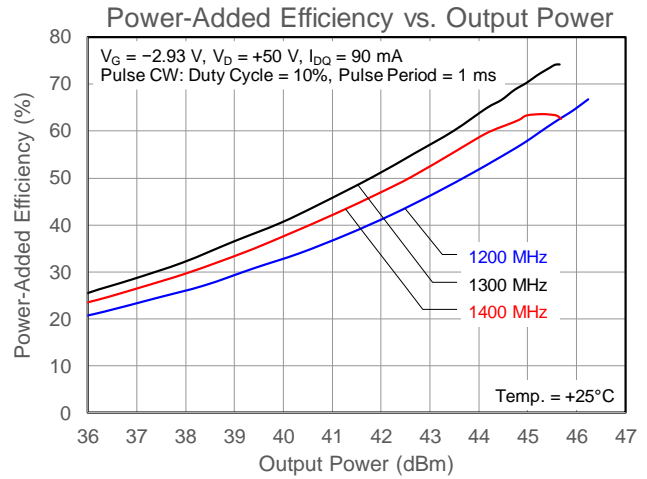
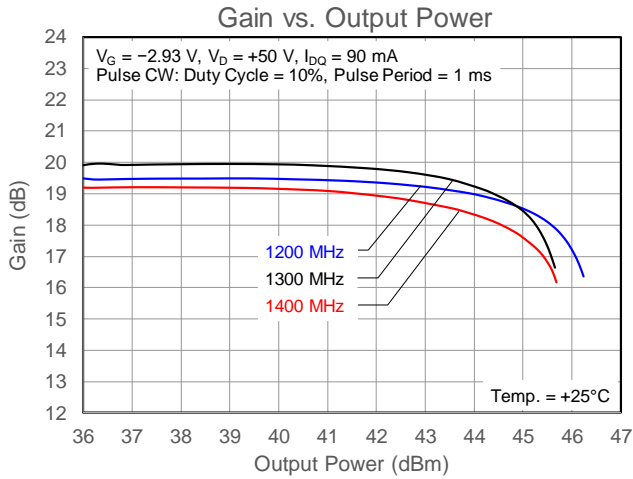
QPD0030EVB01 Performance Plots

Test conditions unless otherwise noted: $V_D = +48\text{ V}$, $I_{DQ} = 90\text{ mA}$, $T = +25^\circ\text{C}$, Pulsed (10% Duty Cycle, 100 μs Width) on a reference design tuned for 1.2 – 1.4 GHz.

QPD0030EVB02 Layout – 1.8 – 2.2 MHz Reference Design

Note: PCB Material is RO4350B, 20 mil thick substrate, 1 oz. copper each side.

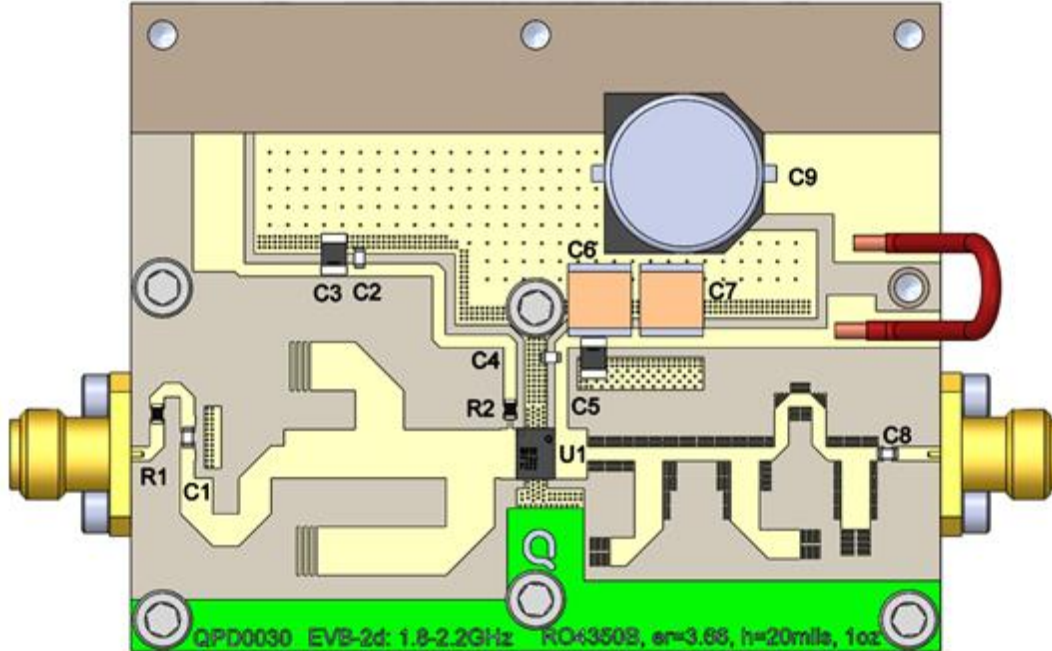

QPD0030EVB02 Bill of Materials

Reference Des.	Value	Description	Manufacturer	Part Number
C1	6.8 pF	RF NPO 250VDC ± 0.25 pF Capacitor	ATC	600S6R8CT250XT
C2, C4	15 pF	RF NPO 250VDC ± 5% Capacitor	ATC	600S150JT250XT
C3	4.7 uF	X7R 50V 10% 1206 Capacitor	Kemet	C1206C475K5RACTU
C5	1000 pF	X7R 630V 10% 1206 Capacitor	Murata	GRM31BR72J102KW01L
C6, C7	10 uF	X7S 100V 20% 2220 Capacitor	TDK	C5750X7S2A106M230KB
C8	20 pF	RF NPO 250VDC ± 5% Capacitor	ATC	600S200JT250XT
C9	100 uF	100V Electrolytic 20% 12.5mm SQ	Vishay	MAL215099907E3
R1	5.1 Ω	0603 5% Thick Film Resistor	Vishay	CRCW06035R10JNEA
R2	10 Ω	0603 5% Thick Film Resistor	Vishay	CRCW060310R0JNEA
C9	100 uF	100V Electrolytic 20% 12.5mm SQ	Vishay	MAL215099907E3

QPD0030EVB02 Performance Plots

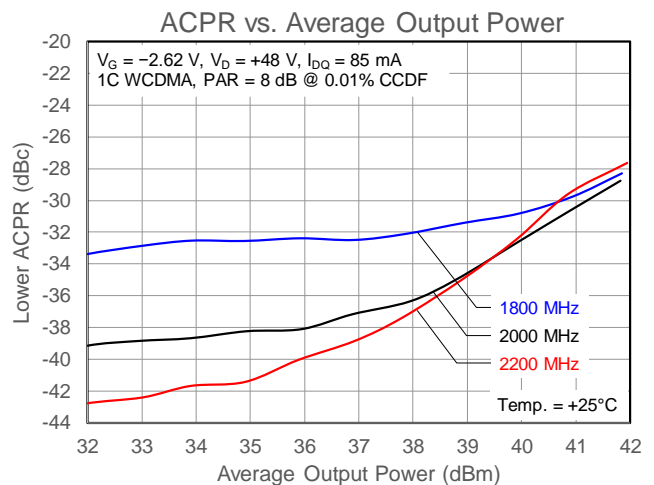
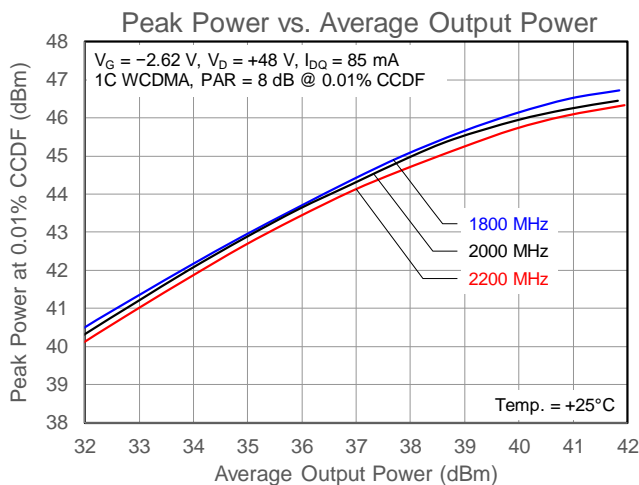
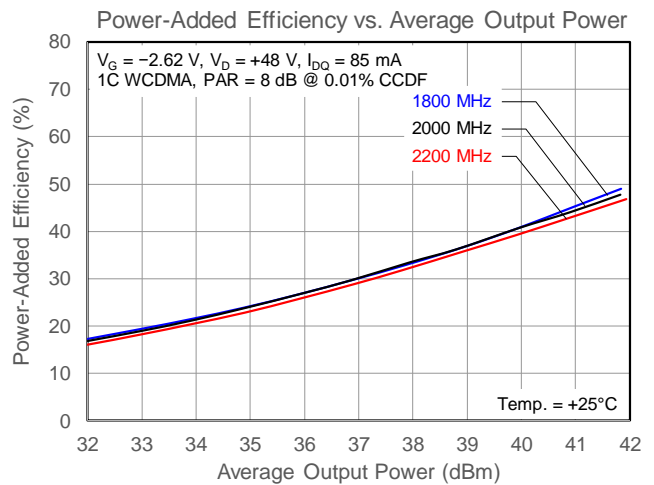
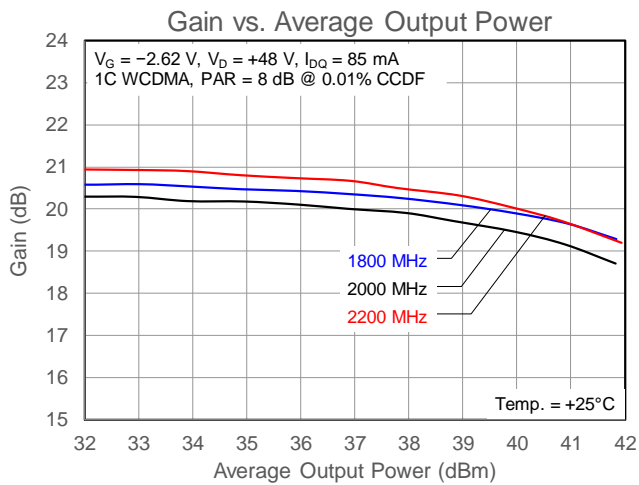
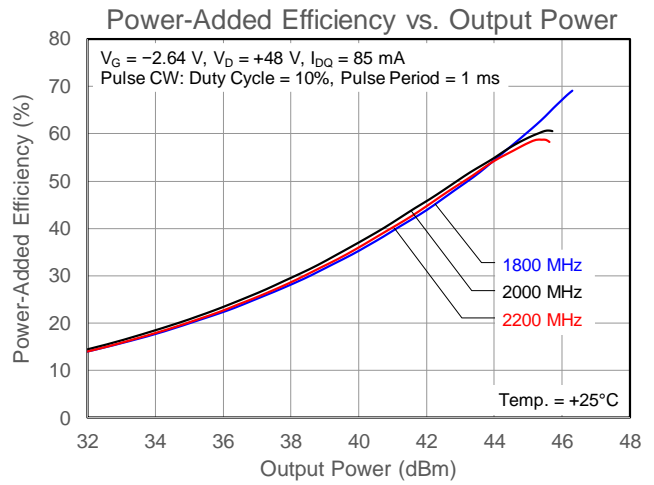
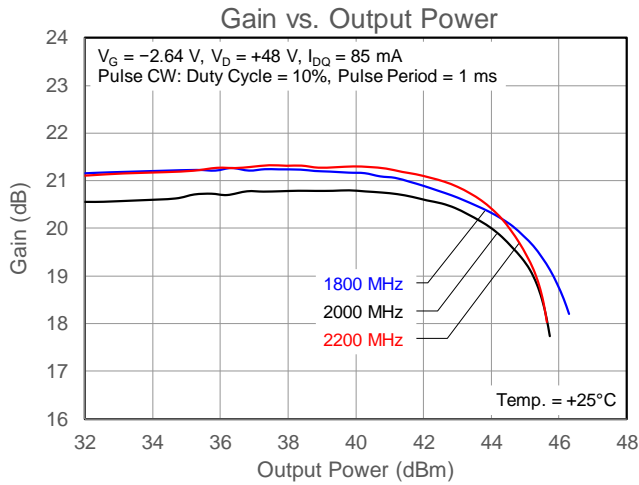

Test conditions unless otherwise noted: $V_D = +48 \text{ V}$, $I_{DQ} = 85 \text{ mA}$, $T = +25^\circ\text{C}$, on a reference design tuned for 1.8 – 2.2 GHz.

Power-Matched Load Pull Performance

Frequency (MHz)	Source Impedance (Ω)	Load Impedance (Ω)	P3dB (dBm)	Drain Efficiency (%)	G3dB (dB)
1800	22.34 – j5.34	9.30 + j4.15	46.9	60.2	21.7
2000	26.00 + j1.18	7.55 + j5.63	46.5	62.5	21.3
2200	18.40 + j2.92	7.04 + j4.47	46.9	56.3	19.5
2500	19.94 + j0.77	6.62 + j3.94	46.8	59.4	18.4
2700	17.74 – j2.94	6.58 + j3.97	46.9	61.7	17.9
4300	9.54 + j1.75	4.99 + j1.48	46.9	59.9	14.8
4900	9.42 – j2.51	3.37 – j0.36	46.7	57.4	14.0

Test conditions unless otherwise noted: $V_D = +48\text{ V}$, $I_{DQ} = 85\text{ mA}$, $T = +25^\circ\text{C}$, Pulse (10% Duty Cycle, 100 μs Width).

Efficiency-Matched Load Pull Performance

Frequency (MHz)	Source Impedance (Ω)	Load Impedance (Ω)	P3dB (dBm)	Drain Efficiency (%)	G3dB (dB)
1800	22.34 – j5.34	8.37 + j12.72	45.3	72.5	23.9
2000	26.00 + j1.18	7.47 + j10.34	45.4	70.4	22.7
2200	18.40 + j2.92	5.05 + j10.28	45.2	71.9	22.1
2500	19.94 + j0.77	4.22 + j8.18	45.2	71.3	20.1
2700	17.74 – j2.94	3.38 + j8.00	44.6	71.5	19.7
4300	9.54 + j1.75	3.26 + j3.23	46.1	62.4	15.9
4900	9.42 – j2.51	2.52 + j1.60	45.7	59.3	15.5

Test conditions unless otherwise noted: $V_D = +48\text{ V}$, $I_{DQ} = 85\text{ mA}$, $T = +25^\circ\text{C}$, Pulse (10% Duty Cycle, 100 μs Width).

Load Pull Contours

Test Conditions unless otherwise noted: $V_D = +48\text{ V}$, $I_{DQ} = 85\text{ mA}$, $T = +25^\circ\text{C}$, Pulse (10% Duty Cycle, 100 μs Width).

Load Pull at 1.8 GHz

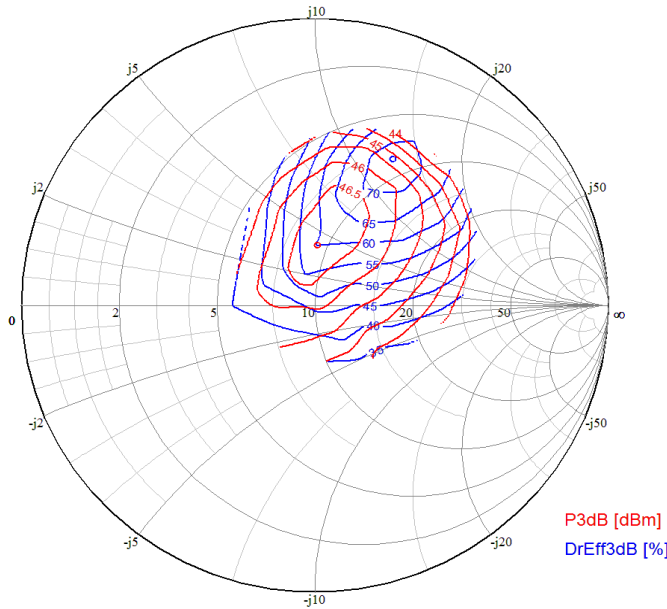

Load Pull at 2 GHz

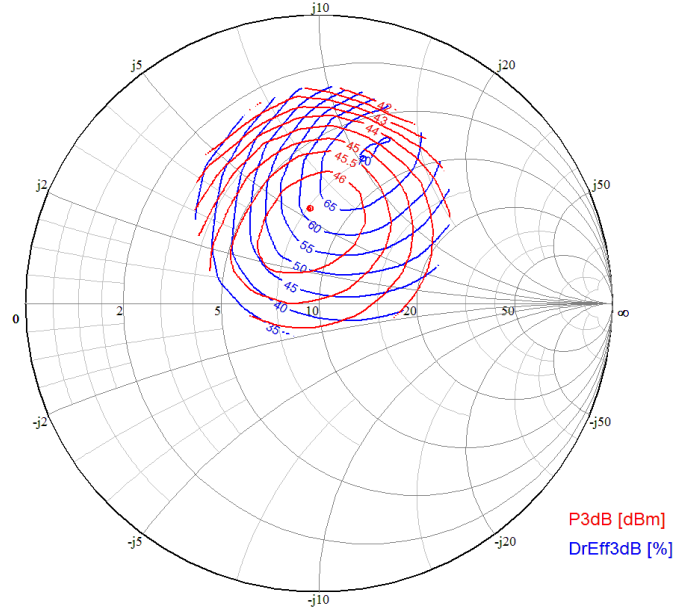

Load Pull at 2.2 GHz

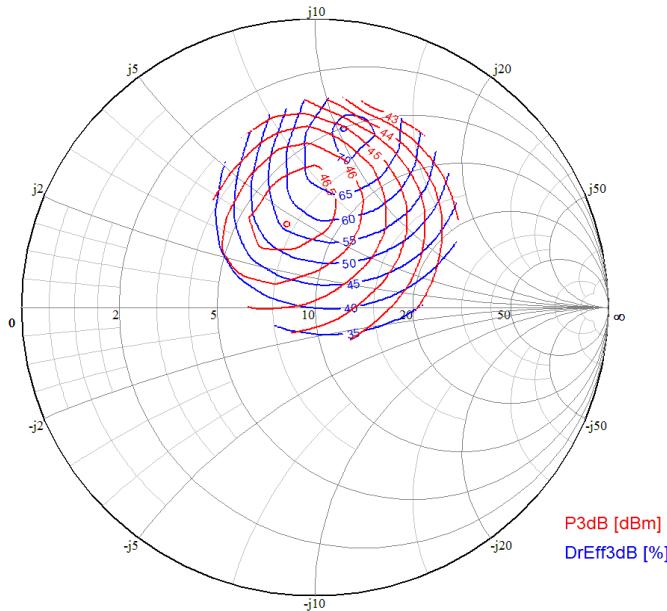

Load Pull at 2.5 GHz

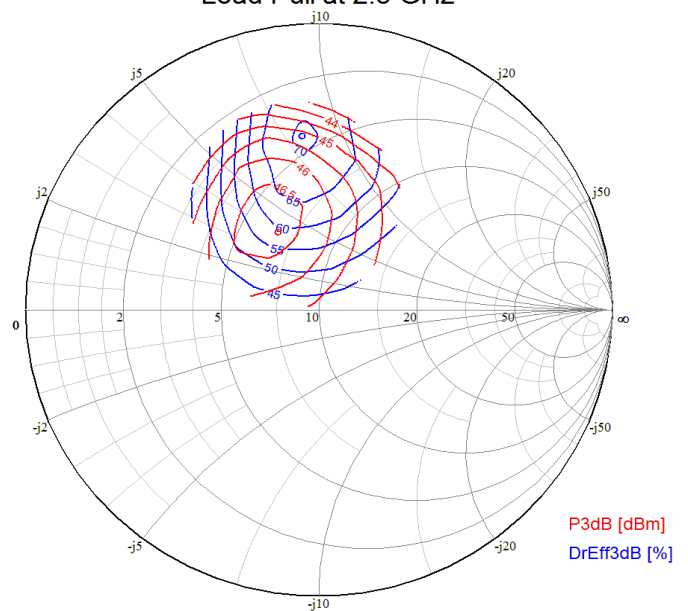

Load Pull Contours

Test Conditions unless otherwise noted: $V_D = +48\text{ V}$, $I_{DQ} = 150\text{ mA}$, $T = +25^\circ\text{C}$, Pulse (10% Duty Cycle, 100 μs Width).

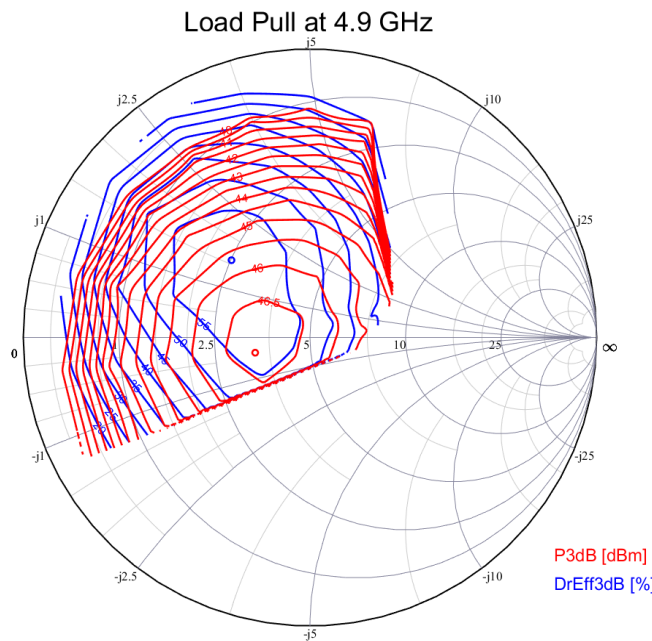
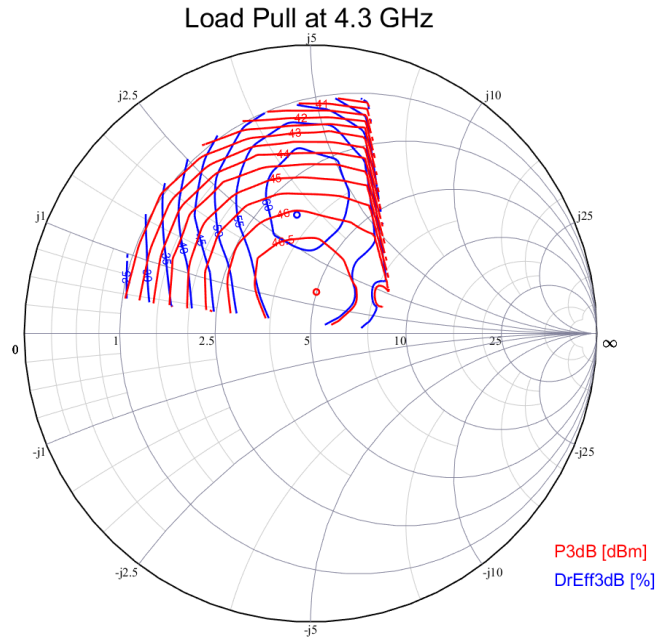
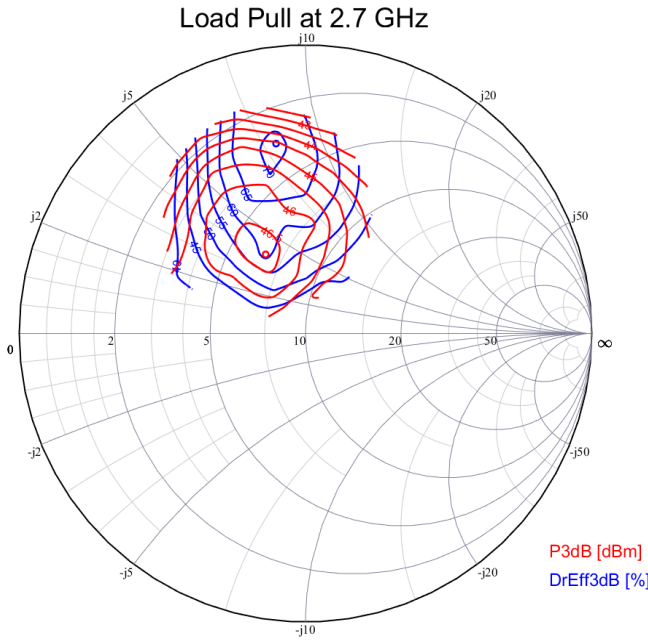

Package Marking and Pin Configuration

Marking: Qorvo Logo
Part Number and Package Version – 0030
Date Code – YYWW
Production Lot Number - MXXX

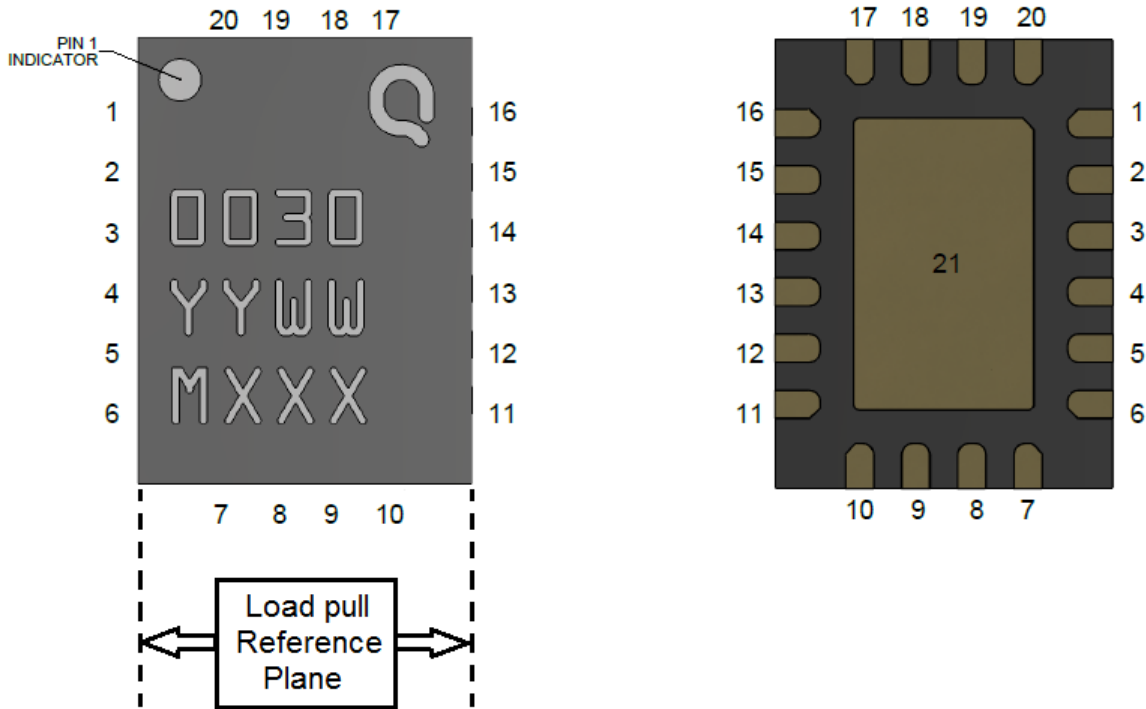

Pin Number	Label	Description
1	NC	Not Connected
2, 3, 4, 5	RF IN / VG	RF Input / Gate Voltage
6, 7, 8, 9, 10, 11	NC	Not Connected
12, 13, 14, 15	RF OUT / VD	RF Output / Drain Voltage
16, 17, 18, 19, 20	NC	Not Connected
21 (Backside Paddle)	GND	Source to be connected to ground.

Bias Procedure

Bias On

1. Turn ON V_G to -4 V.
2. Turn ON V_D to $+48$ V.
3. Slowly adjust V_G until I_D is set to 85 mA.
(Typically, $V_G = -2.8$ V.)
5. Turn ON RF.

Bias Off

1. Turn OFF RF.
2. Set V_G to -5 V.
3. Turn OFF V_D .
4. Wait two (2) seconds to allow drain capacitor to discharge.
5. Turn OFF V_G .

Package Dimensions

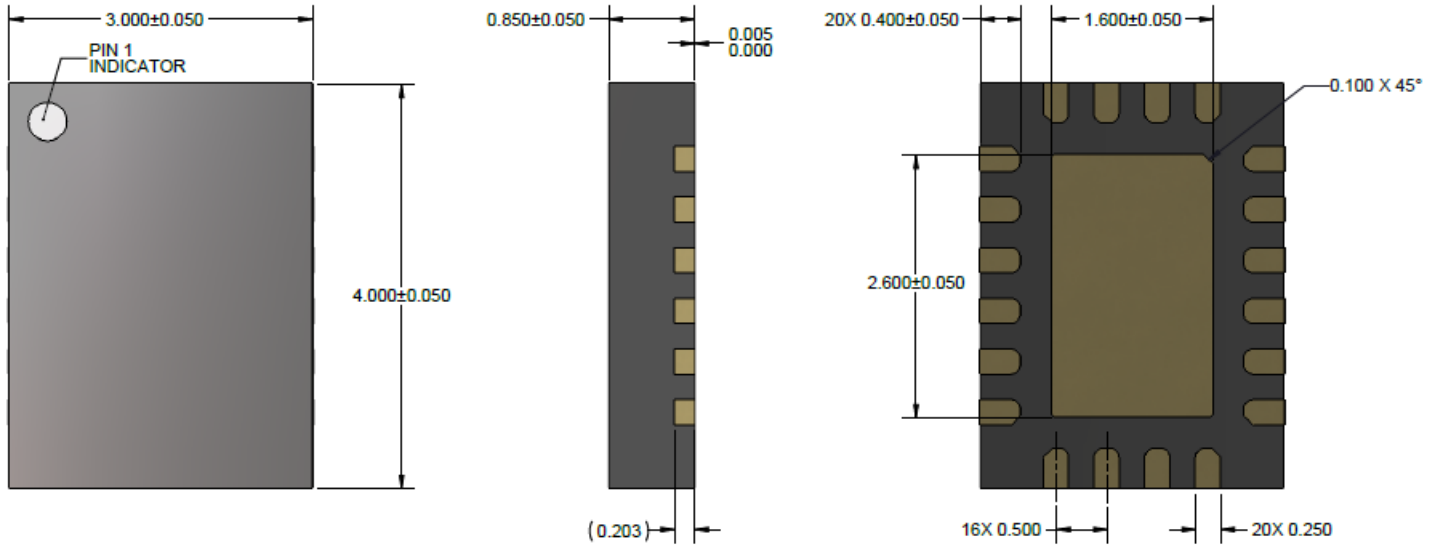

Notes:

1. Dimensions are in millimeters. Angles are in degrees.
2. Part is overmold encapsulated.
3. Contact plating is NiPdAu. Au thickness is 0.00254 to 0.01501 μm .
4. General tolerance is ± 0.050 .

Recommended Solder Temperature Profile

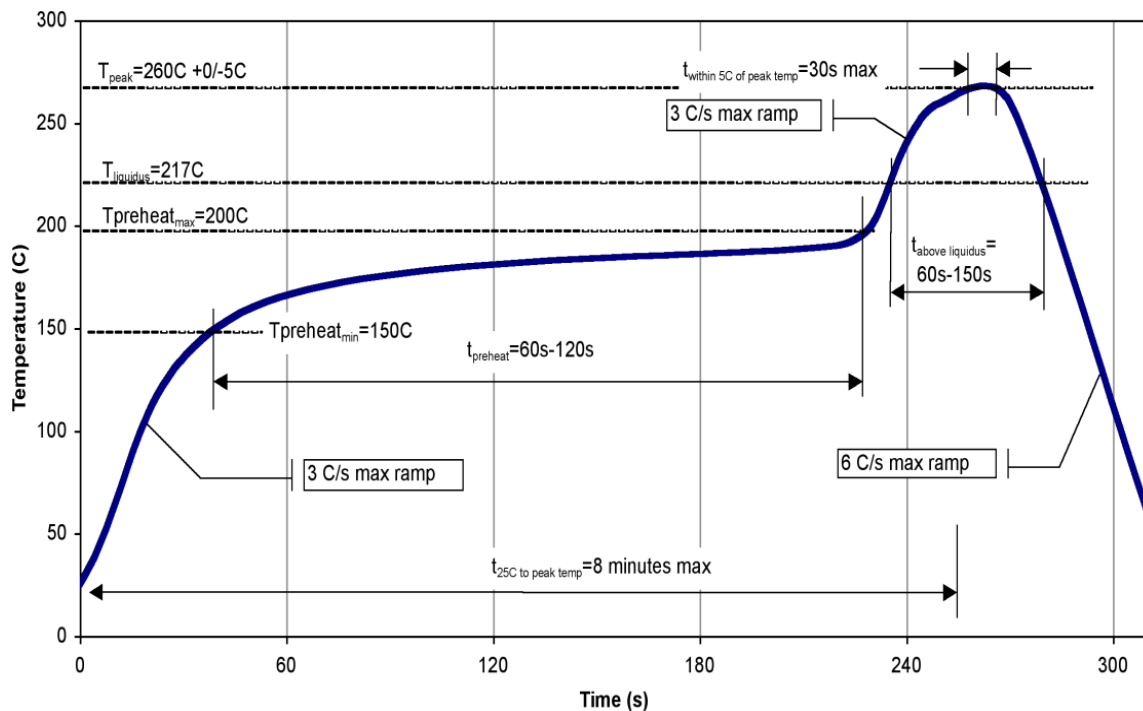

Handling Precautions

Parameter	Rating	Standard
ESD – Human Body Model (HBM)	Class 1A	ANSI/ESDA/JEDEC Standard JS-001
ESD – Charged Device Model (CDM)	Class C3	ANSI/ESDA/JEDEC Standard JS-002
MSL – Moisture Sensitivity Level	Level 3	IPC/JEDEC Standard J-STD-020
HAST – Highly Accelerated Temperature and Humidity Stress Test	Pass	JESD22-A110, 96 Hour Test Conditions, Preconditioned to MSL3 per JESD22-A113



Solderability

Compatible with lead-free (260°C max. reflow temp.) soldering processes.

Package lead plating is NiPdAu. Au thickness is 0.00254 to 0.01501 µm.

RoHS Compliance

This part is compliant with 2011/65/EU RoHS directive (Restrictions on the Use of Certain Hazardous Substances in Electrical and Electronic Equipment) as amended by Directive 2015/863/EU.

This product also has the following attributes:

- Lead Free
- Halogen Free (Chlorine, Bromine)
- Antimony Free
- TBBP-A (C₁₅H₁₂Br₄O₂) Free
- PFOS Free
- SVHC Free



Contact Information

For the latest specifications, additional product information, worldwide sales and distribution locations:

Web: www.qorvo.com

Tel: 1-844-890-8163

Email: customer.support@qorvo.com

Important Notice

The information contained herein is believed to be reliable; however, Qorvo makes no warranties regarding the information contained herein and assumes no responsibility or liability whatsoever for the use of the information contained herein. All information contained herein is subject to change without notice. Customers should obtain and verify the latest relevant information before placing orders for Qorvo products. The information contained herein or any use of such information does not grant, explicitly or implicitly, to any party any patent rights, licenses, or any other intellectual property rights, whether with regard to such information itself or anything described by such information. **THIS INFORMATION DOES NOT CONSTITUTE A WARRANTY WITH RESPECT TO THE PRODUCTS DESCRIBED HEREIN, AND QORVO HEREBY DISCLAIMS ANY AND ALL WARRANTIES WITH RESPECT TO SUCH PRODUCTS WHETHER EXPRESS OR IMPLIED BY LAW, COURSE OF DEALING, COURSE OF PERFORMANCE, USAGE OF TRADE OR OTHERWISE, INCLUDING THE IMPLIED WARRANTIES OF MERCHANTABILITY AND FITNESS FOR A PARTICULAR PURPOSE.**

Without limiting the generality of the foregoing, Qorvo products are not warranted or authorized for use as critical components in medical, life-saving, or life-sustaining applications, or other applications where a failure would reasonably be expected to cause severe personal injury or death.

Copyright 2019 © Qorvo, Inc. | Qorvo is a registered trademark of Qorvo, Inc.