



Quick Reference Guide: Interconnects for the IEEE 1394 Standard

This product conforms to the IEEE 1394 Standard. With only one type of connector, you can connect several different pieces of digital peripheral equipment. The IEEE 1394 Standard connector series is capable of accommodating data rates up to 400 Mbps for serial transmission consisting of 6 position connectors, for connections of computers to peripherals, and the 4 position connectors for connections of digital AV equipment. For connections of computers to digital AV equipment, 4 position to 6 position transition type cable assemblies are used. In order to cope with a wide range of device designs, headers of 4 position connectors are suitable for DVD, STB, etc., and are provided with screw thread size of M1.6, and are available in DIP and SMT types. Cable assemblies are also available in 4 position to 4 position type for connection of AV equipment, 4 position to 6 position transition type for connections of PC and AV equipment, and 6 position to 6 position type for connections of PC and peripherals.

FEATURES AND BENEFITS

- Conforms to IEEE 1394 Standards (4 position, 6 position)
- Easy connections to equipment (4 position, 6 position)
- For use with plug and play devices
- Panel mounting screw thread sizes of PC board side are of M1.6 and M2.1 (4 position)
- DIP types and SMT types are available for PC board side (4 position, 6 position)
- Applicable for automatic mounting machines with embossed tapes (4 position)
- FPC is also applicable to the 4 position connectors

PRODUCT APPLICATIONS

- Cameras
- Camcorders
- Scanners
- Printers
- DVD Players
- Set-Top Boxes
- Computer Monitors
- Audio Video Receivers
- Hard Drives
- Audio Recording Devices

IEEE 1394 Standard is a trademark of the Institute of Electrical and Electronics Engineers, Inc. and licensed to the IEEE 1394 Standards Association.

<http://www.tycoelectronics.com/products/IEEE1394>

 **Tyco Electronics**
Our commitment. Your advantage.

PRODUCT SIZES

4 Position

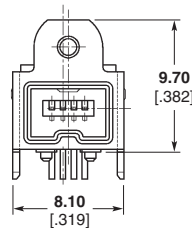

6 Position

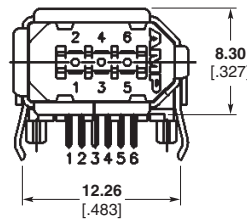



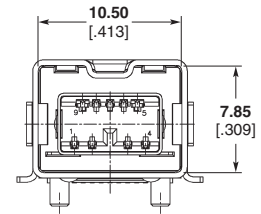

9 Position



IEEE 1394 STANDARD - USB INTERCONNECTS COMPARISON CHART

	IEEE 1394 Standard	USB 2.0 Interconnects
Printed Data Rate	400 Mbps	480 Mbps
Sustained Data Rate (Read)	38 MB/s	33 MB/s
Sustained Data Rate (Write)	35 MB/s	27 MB/s
Cycle Life	1000 cycles (4 Position) 1500 cycles (6 Position)	1500 cycles
Architecture	Peer to Peer	Master / Slave
Advantages	Well suited to accommodate multimedia devices	Lower cost, standard on most computers
Drawbacks	Higher cost, not standard on personal computers	Must be used in conjunction with a computer

4 POSITION

	Part Number	Gender	Orientation	Board Mount	Tail Length	Feature
	353388-1	Receptacle	Right Angle	Through Hole	2.00	Flange M1.6
	1-1734056-1	Receptacle	Right Angle	Through Hole	2.60	Boss
	1-1734056-2	Receptacle	Right Angle	Through Hole	2.60	Without Boss
	1123843-1	Receptacle	Right Angle	Surface Mount	3.85	Flange M1.6
	1318141-1	Receptacle	Right Angle	Surface Mount	N/A	Flange Ø2.
	1318140-1	Receptacle	Right Angle	Surface Mount	N/A	Without Boss
	1674260-1	Receptacle	Right Angle	Through Hole	2.80	Stacked
	1318714-1	Receptacle	Vertical	Through Hole	2.00	Flange M1.6
	1734681-1	Receptacle	Edge Mount	Through Hole	2.00	
	1734194-1	Receptacle	Edge Mount	Surface Mount	N/A	
	1717700-1	Plug Kit	Plug Kit	N/A	N/A	N/A

PRODUCT SPECIFICATION: 108-5157

Note: All part numbers are RoHS compliant. All dimensions in mm unless otherwise stated.

IEEE 1394 Standard is a trademark of the Institute of Electrical and Electronics Engineers, Inc. and licensed to the IEEE 1394 Standards Association.

<http://www.tycoelectronics.com/products/IEEE1394>

6 POSITION

	Part Number	Gender	Orientation	Board Mount	Tail Length	Color
 5788516	5788516-1	Receptacle	Right Angle	Through Hole	2.00	Black
	1734368-1	Receptacle	Right Angle	Surface Mount	SMT	Black
 1734290	1734368-2	Receptacle	Right Angle	Surface Mount	SMT	Natural
	1734290-1	Receptacle	Vertical	Through Hole	2.69	Black
 5787956	1734290-2	Receptacle	Vertical	Through Hole	3.18	Black
	5787956-1	Receptacle	Flag	Through Hole	3.36	Black
 5787950	5787950-1	Plug Kit	Cable Plug	N/A	N/A	Gray

PRODUCT SPECIFICATION: 108-1606

9 POSITION

	Part Number	Gender	Orientation	Board Mount	Tail Length	Color
 1734047	1734047-1	Receptacle	Right Angle	Surface Mount	SMT	Black
	1775021-1	Plug Kit	Cable Plug	N/A	N/A	Black

PRODUCT SPECIFICATION: 108-57567

CABLE ASSEMBLIES

	Base Number	Available Lengths (m)
4 Position to 4 Position	1123076	0.5 - 4.5
	6324771	0.3 - 0.5
4 Position to 6 Position	6324771	0.7 - 4.5
	1324770	0.3 - 0.5
6 Position to 6 Position	1324770	0.7 - 4.5

Note: All part numbers are RoHS compliant.
All dimensions in mm unless otherwise stated.

Interconnects for the IEEE 1394 Standard

QUESTIONS TO ASK AT DESIGN IN

- What is the standard data transfer rate for Interconnects for the IEEE 1394 Standard?
Interconnects for the IEEE 1394 Standard can achieve data transfer rates of up to 400Mbps.
- What are the differences between IEEE 1394 and USB?
See IEEE 1394 Standard - USB Interconnects Comparison Chart on page 2.
- There are only base numbers listed in the Cable Assembly section, how do I find the exact part number?
The part numbers for IEEE 1394 Standard cable assemblies are based on cable length. For more details go to www.tycoelectronics.com. You will find Interconnects for the IEEE 1394 Standard by selecting cable assemblies and then copper industry standard.

YOU ARE HERE (E-CATALOG)

[Link](#)

<http://www.tycoelectronics.com/products/IEEE1394>

[Breakdown From Main Page](#)

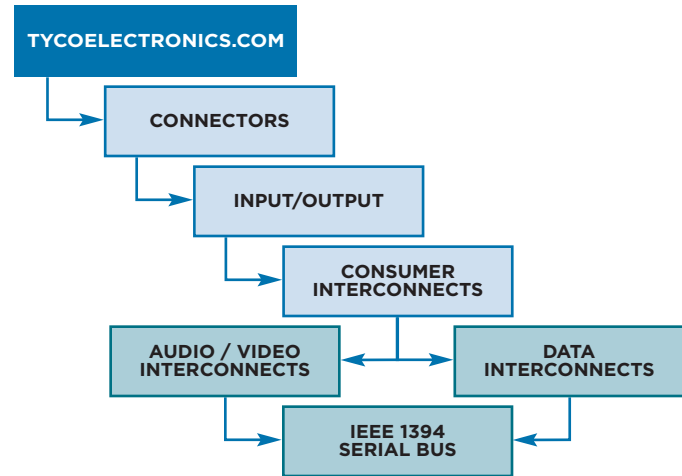

Disclaimer

While Tyco Electronics has made every reasonable effort to ensure the accuracy of the information in this catalog, Tyco Electronics does not guarantee that it is error-free, nor does Tyco Electronics make any other representation, warranty or guarantee that the information is accurate, correct, reliable or current.

Tyco Electronics reserves the right to make any adjustments to the information contained herein at any time without notice. Tyco Electronics expressly disclaims all implied warranties regarding the information contained herein, including, but not limited to, any implied warranties of merchantability or fitness for a particular purpose.

The dimensions in this catalog are for reference purposes only and are subject to change without notice. Specifications are subject to change without notice. Please consult Tyco Electronics for the latest dimensions and design specifications.

Restriction on the use of Hazardous Substances (RoHS)

At Tyco Electronics, we're ready to support your RoHS requirements. We've assessed more than 1.5 million end items/components for RoHS compliance, and issued new part numbers where any change was required to eliminate the restricted materials. Part numbers in this catalog are identified as:

RoHS Compliant — Part numbers in this catalog are RoHS Compliant, unless marked otherwise. These products comply with European Union Directive 2002/95/EC as amended 1 January 2006 that restricts the use of lead, mercury, cadmium, hexavalent chromium, PBB, and PBDE in certain electrical and electronic products sold into the EU as of 1 July 2006.

NOTE: For purposes of this Catalog, included within the definition of RoHS Compliant are products that are clearly "Out of Scope" of the RoHS Directive such as hand tools and other non-electrical accessories.

NOTE: Information regarding RoHS compliance is provided based on reasonable inquiry of our suppliers and represents our current actual knowledge based on the information provided by our suppliers. This information is subject to change. For latest compliance status, refer to our website referenced at right.

Getting the Information You Need

Our comprehensive on-line RoHS Customer Support Center provides a forum to answer your questions and support your RoHS needs. A RoHS FAQ (Frequently Asked Questions) is available with links to more detailed information. You can also submit RoHS questions and receive a response within 24 hours during a normal work week. The Support Center also provides:

- Cross-Reference from Non-compliant to Compliant Products
- Ability to browse RoHS Compliant Products in our on-line catalog
- Downloadable Technical Data Customer Information Presentation
- More detailed information regarding the definitions used above
- So whatever your questions when it comes to RoHS, we've got the answers at www.tycoelectronics.com/leadfree

RoHS
Customer
Support
Center

© 2008 Tyco Electronics Corporation. All Rights Reserved.

TE LOGO and TYCO ELECTRONICS are trademarks. Other products, logos and company names mentioned herein may be trademarks of their respective owners.

IEEE 1394 Standard is a trademark of the Institute of Electrical and Electronics Engineers, Inc. and licensed to the IEEE 1394 Standards Association.

Dimensions are in millimeters with inches (if shown) in brackets. Specifications subject to change.

For more information, contact your Tyco Electronics sales engineer at the numbers listed below, or visit our Website at: <http://www.tycoelectronics.com>.

USA: 1-800-522-6752
Canada: 1-905-470-4425
Mexico: 01-800-733-8926

C. America: 52-55-1106-0803
S. America: 55-11-2103-6000
Hong Kong: 852-2735-1628

Japan: 81-44-844-8013
UK: 31-73-6246-431

5-1773453-9-2.5K-FP-LUG-11/08

Tyco Electronics

Our commitment. Your advantage.