

# EA uniTFT

## Multifuncion 5" TFT HMI



### FEATURES

- WITH and WITHOUT TOUCHPANEL
- ANALOGUE RESISTIVE TOUCH OR CAPACITIVE - PCAP
- OBJECT BASED SCREEN DESIGN
- CHANGE OBJECTS: SIZE, SHAPE, COLOR, VISABILITY, CONTENT
- VECTOR GRAPHICS, LOSS FREE ROTATION AND ZOOM
- ALPHA BLENDING, MOVING OBJECTS
- VECTORIZED CHARACTER SET AS ASCII AND UNICODE
- SINGLE SUPPLY 3.3 V
- 7 INTERFACES: USB, 2 x I<sup>2</sup>C, 2 x SPI, 2 x RS232
- 16 DIGITAL I/O ONBOARD, EXPANDABLE UP TO 125
- 4 ANALOGUE INPUTS
- PWM OUTPUT
- BUILT-IN RTC INCL. BATTERY BACKUP
- MICRO SD-CARD USED FOR PICTURES, FONTS, MACROS

### ORDERING CODES

#### DISPLAYS

MULTI FUNCTION 5" TFT 800x480 DOTS, 24 BIT WITH BACKLIGHT  
 INCL. RESISTIVE TOUCHPANEL  
 INCL. CAPCITIVE TOUCHPANEL - PCAP

#### ACCESSORIES

5" uniTFT WITH PCAP PLUS PROGRAMMER BOARD  
 5" uniTFT WITH RES: TOUCH PLUS PROGRAMMER BOARD  
 MICROMATCH CONNECTOR THT, 26 PIN (2 PCS. REQUIRED)  
 MICROMATCH CONNECTOR IDC CRIMP CONNECTION, 26 PIN (2 PCS.  
 REQUIRED)

**EA uniTFT050-A**  
**EA uniTFT050-ATP**  
**EA uniTFT050-ATC**

**EA QUICKuniTFT050C**  
**EA QUICKuniTFT050P**  
**EA B2B127M-26T**  
**EA B2B127M-26Q**

**TABLE OF CONTENT**

<b>Features</b> .....	<b>1</b>
<b>Ordering codes</b> .....	<b>1</b>
<b>Table of content</b> .....	<b>2</b>
<b>Revision</b> .....	<b>5</b>
<b>General information</b> .....	<b>6</b>
Method of working of the display .....	6
Objects .....	6
Styles .....	6
Drawing style and line style .....	6
Text style .....	6
Button style .....	6
Styles and objects .....	6
Command syntax .....	7
Command parameters .....	8
Angels .....	8
Comments .....	9
Object area .....	9
Entering figures .....	10
Entering strings .....	10
String file .....	10
Path details, Files and Formatting .....	12
Path details .....	12
Data Types .....	13
Formatted strings .....	13
Date and Time .....	14
Images .....	15
Image formats .....	15
Polyline and polygons .....	16
Segment .....	16
Indicators .....	16
Directions of movement and arcs .....	16
Anchor .....	18
Groups .....	19
Calculation .....	20
Action and Animation .....	25
ACtion .....	25
Animation .....	25
safety instructions .....	25
Avoid electric shock and fire .....	25
Care and use .....	25
<b>Hardware</b> .....	<b>27</b>
Pin assignment .....	27
RS232 .....	28
Data format .....	28
Baud rates .....	28
Application examples .....	29
RS232 V24 - connection to a PC .....	29
RS485 - bus system .....	29
SPI .....	30
I <sup>2</sup> C .....	32
USB .....	33
SD CARD .....	34

Video input/camera .....	34
AnalogUE Input .....	35
Pulse width modulation (PWM) .....	36
Input/Output (I/O) .....	37
Short Protocoll & Small Protocoll .....	38
Short Protocoll .....	40
Small Protocoll .....	42
Checksum calculation .....	43
Short Protocoll .....	43
Small Protocoll .....	44
<b>Commands .....</b>	<b>45</b>
Command overview .....	45
Terminal .....	45
Images/vector graphics .....	47
Add image/vector graphic. ....	47
Types of animation .....	48
Style sheets .....	49
Colour gradients and line patterns .....	49
Drawing style .....	49
Line style .....	51
Text style .....	52
Touch button style .....	53
Drawing/graphic primitives .....	55
Segment types .....	58
Strings and character string commands .....	59
Edit box .....	60
Touch objects / Touch functios .....	62
Definition of Touch objects .....	62
Touch functions .....	63
Bar graphs and instruments .....	65
ObjectS .....	68
Definition of Objects .....	68
Change of objects .....	69
Variables and Registers .....	72
Macros .....	74
Executing macros .....	74
Definition of macro processes and touch macros .....	75
Types of analogue macros .....	76
Time and date .....	78
Action .....	79
Operational curves and paths .....	79
Define action .....	79
Action .....	79
Define Actions .....	81
Action type .....	82
Pre-defined action curves .....	83
Keyboard .....	88
Peripherals - interface .....	90
Analogue .....	90
Pulse width modulation (PWM) .....	91
Port .....	91

Video and Audio .....	92
RS232 Master interface .....	92
Spi Master interface .....	93
I <sup>2</sup> c .....	95
System commands .....	96
Boot menu and touch adjustment through gestures .....	98
File access .....	100
SD-Card .....	100
File time .....	102
Responses .....	103
Examples of commands .....	106
Operation and animation .....	107
Bild / Vektorgrafiken .....	110
Ein- und Ausgänge .....	111
Instruments .....	112
Keyboard .....	114
String Zeichenkettenbefehle .....	115
Editbox .....	116
Style sheets .....	117
Terminal commands .....	121
Touch control objects/touch control functions .....	122
Time .....	123
Drawing/graphic primitives .....	124
Segmenttypen .....	127
Commands for the examples .....	130
Operation and animation .....	130
Instruments .....	135
Keyboard .....	139
Character string commands in a string .....	140
Style sheets .....	141
Terminal commands .....	145
Touch control objects/touch control functions .....	146
Time .....	147
Drawing/graphic primitives .....	148
Segment types .....	151
<b>Electrical Specification .....</b>	<b>158</b>
<b>dimensions .....</b>	<b>159</b>

**REVISION**

Datum	Version / Firmware	Beschreibung
23.08.2016	0.9	First release

## GENERAL INFORMATION

### METHOD OF WORKING OF THE DISPLAY

The representation on the display is effected based on the commands given by the user. Every item on the display is an independent [object](#) and can be manipulated. The appearance, i.e. the colour data, the fonts, the line strengths, etc. is merged to form [styles](#) .

### OBJECTS

In order to generate various objects, the corresponding commands are available. Every image, every text and every button is a so-called object. Every object needs to be endorsed with an object ID which makes it clearly identifiable. If an object ID is assigned, and if said object ID is re-assigned the previous object is overwritten. Thus, when using objects that occur on multiple screen pages, care is needed so that the latter are not overwritten.

### STYLES

There are various styles based on which objects can be displayed, such as colour, line strength or transparency. The corresponding commands and examples can be inferred from the [Style Sheets](#) section.

Just as with the objects, styles are saved in corresponding IDs, which can also be overwritten. The various style groups have their own ID range. That means that a button style and a drawing style with the ID 1 can exist alongside one another simultaneously. The maximum number of styles is 255 for every range, which is why using a local definition needs to be taken into consideration when using very many styles.

### DRAWING STYLE AND LINE STYLE

Except in the case of images, every object is generated with a border and a filling. The drawing style determines precisely those. In that respect, both the [filling](#) and the [border](#) (line) can be defined, omitted entirely or designed to be transparent. Besides having a plain colour filling, a colour gradient is, moreover, also possible. In the case of the line, it is not possible to define a colour gradient. In addition, both a dash pattern (dotted) can be defined, and also the ends rounded off. The line style is a component of the drawing style, which is why it is recommended for the overview to always specify both together.

### TEXT STYLE

The [Text Style](#) needs to be defined if it is intended to work with strings. The latter contain the information on the font used, as well as its formatting. As a string is likewise an object, reference is also made, in the text style, to an existing drawing style, in order to provide the font with a filling and border. For performance reasons, we recommend a drawing style without a border (line).

### BUTTON STYLE

Text and drawing styles form the basis for the [Button Style](#). In order to design touch control buttons which have a different visual appearance in the pressed state, in comparison to the unpressed state, in certain circumstances multiple drawing and text styles are required. Information, such as touch feedback, e.g. playing short jingles upon activation or enlarging the button is likewise stored in this style.

### STYLES AND OBJECTS

In order to be able to switch between various different screen pages, all the existing objects first always need to be [deleted](#) Precisely in menus, you can often find a fixed structure, so that individual objects only need to be

deleted in a targeted manner, and others can remain in place.

Below is an example, to make it clear how handling objects works.

Once the display has been started, a main menu is opened, with a background (ID=100), Logo(ID=101) and two touch buttons(ID= 1,2) for selecting the sub-menu. A button style(number=1) is, furthermore, defined for the touch control buttons.

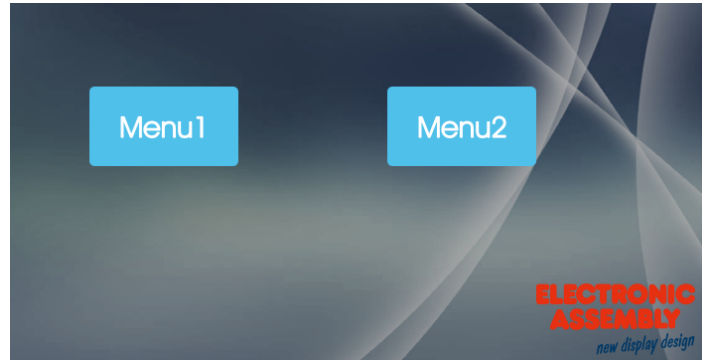

The background, logo and button style should also be present in the sub-menus. In order not to overwrite these objects, using the object IDs should be discontinued. A heading with a corresponding style, as well as a line, are supposed to be generated in Menu 1. All objects still existing that are no longer required are to be deleted in advance. In this case that is Objects 1 to 99. The deletion is performed by entering the delete command for objects(→ [#ODI 1-99](#)). The result can be seen in the figure below.



Naturally, the objects in Menu 1 and Menu 2 can be used in the same way.

## COMMAND SYNTAX

A command always begins with '#'. Subsequently there is a 3-digit sequence of digits - the command code. Depending upon the command code, further parameters are required. In order to separate the parameters, one of the following characters needs to be used:

- Space
- Comma( , )
- Full stop( . )
- A semicolon ( ; ) (only and mandatorily at the end of a string)
- Specified range of multiple object IDs: '-' sign: e.g. 1-5, instead of 1,2,3,4,5.

The command always needs to be concluded by an LF (line feed) Should the line feed not exist, the command is not executed.

Example::

- Individual command to generate Line Style 1 `#CLS1 $3B7EAE,100,1,0,1(Line Feed)`
- Multiple commands to generate an animation of Object 1 `#AOA1 501,0 (Line Feed)`  
`#AOT1 1,250,100,100 (Line Feed)`

There are commands which relate to files. Those are likewise written in quotation marks or inverted commas. These commands have recorded in them, as their reference point, the default folder, and thus an automated path specification.

## COMMAND PARAMETERS

Parameters that are written in **GRAY** in the command tables are considered optional details, and partially have default values. The default values are given in brackets behind the corresponding parameters. Parameters written in **BLACK** must be transferred.

## ANGELS

Angles are specified in the mathematical direction of rotation, i.e. anti-clockwise. It is likewise possible to enter negative angles. The direction of rotation and the angular distribution can be discerned in the figure below.

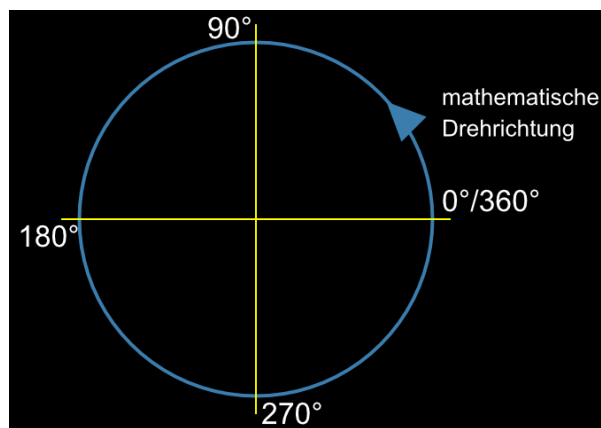

The co-ordinate system extends in a range from 800(x) \* 480(y). The origin (0/0) is in the lower left-hand corner.



## COMMENTS

The option exists to add comments in the command input in macro files. Considerations concerning command sequences can be explained thereby, and a better understanding ensured. A comment begins with #- (hash key minus) and applies until the end of the line, i.e. once the comment line is supposed to contain a wrap, the next line likewise has to begin with #- in order to continue the comment.

## OBJECT AREA

In the case of commands having the property of influencing one or more objects (marked by: "Object ID"), the object area can be specified by a hyphen, "-". In the example contained in the section, [Styles and Objects](#), the application is highlighted.

## ENTERING FIGURES

Input	Definition
123	Decimal handover as ASCII character/s
\$5A	Hexadecimal handover as ASCII character/s
%101001	Binary handover as ASCII character/s
?x	Code of a character (Unicode /ASCII)
R0..R255	Handover of the register value
Q0..Q255	Accept register value indexed = R(R0..255).
(...)	Accept result of the calculation string
G len32 data...	Submit binary data: G len 32-bit - binary, followed by binary data
!string!	Infer values and strings from string file, replacement

## ENTERING STRINGS

Should strings be used as parameters, it should be remembered that the latter need to be placed in quotation marks ( "" ) or inverted commas ( ' ' ), and be ended by a semicolon ( ; ). Should a string be the last parameter in the command code, no semicolon needs to be placed at the end of the string. The maximum length permitted for any string is 255 characters. A line break within a string is implemented with the pipe sign '|' or new line '\n'.

- Beispiel: "string1"; 'string2'

Eingabe	Definition
"Hello"32'World'	Eingabe eines Strings. Da kein ; vorhanden ist werden die Strings zusammengesetzt. Der Code dazwischen wird ebenso eingefügt. Ausgabe: Hello World
"Hello\nWorld" = "Hello World"	Mehrzeilige Eingabe eines Strings
S0..255	Stringregister übernehmen.
T0..255	Stringregister indiziert übernehmen, Stringregisternummer aus Register S(R0..255).
U"Hello"	Zeichen nach dem U als 16-Bit Unicode (bis zum nächsten # oder V auch CR + LF)
V"Hello"	Zeichen nach dem V als 8-Bit ASCII (bis zum nächsten # oder U auch CR + LF)
!string!	Werte und Strings aus Stringdatei entnehmen und einsetzen.

## STRING FILE

String files are text files written externally. String files can be used as a sort of database of strings. The strings stored in such a way can be accessed by the name for accessing the string being written between two exclamation marks ! No quotation marks "" may be used, as otherwise only the access as a string is shown, however the desired string file is not loaded. To use this function, the text file created only needs to be found in the String folder of the SD card, and be loaded by the command to load a string file ([#VFL](#)) . By way of clarification, an example is given below:

The text file *Hallo.txt* created externally and copied onto the SD card looks as follows:

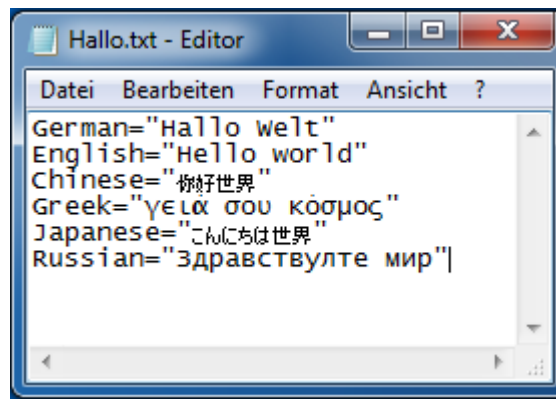

Silt serves the purpose of using multilingualism in regard to the statement "Hello, World". The text file is first of all loaded through [#VFL](#) "Hallo". Should a string now be placed by the command! [#SSP](#) 1, 1, 400, 240, 5 !German!  
"!English!", the result looks as follows:

Hallo Welt  
Hello World

The pipe sign | is necessary for the line break. So that it counts for the string to be displayed, the latter needs to be written in quotation marks ""Without using the string file, the above command would read [#SSP](#) 1, 1, 400, 240, 5 "Hallo Welt" "|" "Hello World".

## PATH DETAILS, FILES AND FORMATTING

### PATH DETAILS

There are two ways of indicating the path. In absolute and relative terms, respectively.

Designation	Example
Absolute path details	</Ordner/Unterordner>
Relative path details	<.../Unterordner>

The absolute path details should be used to work with files outside the project path set. The project path, which is defined by the command [XPS](#) serves to simplify matters. It is not necessary to specify the superordinate directories. By entering "P:" prior to specifying the path, the project paths are automatically added.

If a file is to be accessed in the project folder "picture" set, that can be done absolutely or relatively, as shown in the following example:

**Absolute path details:** </Ordner/Ordner/Ordner/Projekt/picture/Test.epg

**Relative path details:** <p:/picture/Test.epg → The project path has been set as "[#XPS](#) </Ordner/Ordner/Ordner/Projekt>"

When specifying the path, upper and lower case are to be taken into account.

One more simplification::

**There is a series of default folders that are automatically created in the project folder and may NEVER be changed, as, otherwise, command parameters that automatically access these folders no longer work!**

This folder structure is defined as follows:

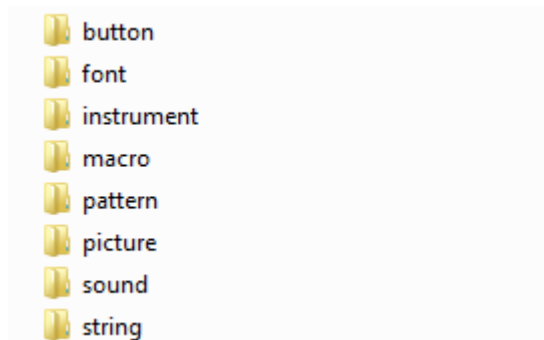

Example:

[#PPP1](#), "Test", 100, 100

With this command, the "test" image is shown on the display at the position 100,100.

An alternative programming step would be: [#PPP1](#), <P:/picture/Test.epg>, 100, 100 .

The same occurs with macros, string files (rather than strings), patterns, buttons (images), sounds, instruments and fonts. The default folders may never be changed. Sub-folders in the default folders are allowed, however need to be specified as well in file names.

## DATA TYPES

Zur Verwendung von Bild- oder Sounddateien müssen diese umgewandelt beziehungsweise konvertiert werden. Das geschieht automatisch durch die Verwendung der Software *uniSKETCH*, indem dort die Dateien eingebunden werden.

Das uniTFT kann nur mit folgenden Dateitypen arbeiten:

Dateityp	Beschreibung
.evg	Format für Vektorgrafiken
.epa	Format für animierte Bilder
.epg	Format für Pixelgrafiken
.esd	Format für Sounddateien
.evf	Format für Vektorfonts
.epf	Format für Pixelfonts
.epi	Format für Pixelinstrumente
.emc	Format für Macros ( Das Makro <i>start.emc</i> startet automatisch nach PowerOn oder Reset.)
.txt	Format für Stringfiles

Andere Dateiformate können zwar im internen Speicher abgelegt, jedoch nicht vom uniTFT genutzt werden.

## FORMATTED STRINGS

Formatted strings rely on the “printf” output function of C. It is thereby possible to display a string that, for example, contains numerical values of a calculation. The maximum length permitted for any formatted string is 63 characters.

Designation	Character	Description
Integer	%d	Displays number as a string.
Double	%f	Displays numbers with a decimal place as a string.
Hexadezimal	%x, %X	Displays hexadecimal numbers as a string.

A formatted string could look as follows:

[#SFP](#)1, 3, 400, 240, 5, "Integer: %d, Float: %.5f, Hexadezimal: %X"; (1+1+1), (3.14159265359), (9+6)

With corresponding text and drawing styles, the result appears as follows:

**Integer: 3, Float: 3.14159, Hexadezimal: F**

## DATE AND TIME

The file format is a special form of the formatted string and describes the date, including the time. A further explanation on the date format can be found [here \(#WDF\)](#).

In the table below, the input commands for the file format are listed.

Eingabe	Definition
%[ ]h	Hour
%[ ]m	Minute
%[ ]s	Second
%[ ]D	Day
%[ ]M	Month
%[ ]Y	Year
%{ }W	Name of weekday as a string
%{ }N	Name of month as a string
[ ] (optional)	<b>0</b> = Two digits with a preceding 0 (Default) <b>1</b> = At least one digit without a preceding character <b>2</b> = Two digits with preceding blank spaces <b>4</b> = Four digits (default for years)
{ } (optional)	<b>0...9</b> = Display the first X characters from the string.

Example:

**#SDP**

**Date and Time**  
 Placing a formatted date

[#SDP](#) 1, 1, 50, 50, 17, "%W the %D. %3N %Y, %1h:%m"

**Thursday the 21. Apr 2016, 11:37**

## IMAGES

The module internally uses a special image format (\*.epg). The conversion needs to be done externally. The Windows program EA uniSketch offers the most comfortable option to have most image formats converted. Some [commands](#) make it possible to save the screen content on the SD card or transfer image data directly via the serial interface. Various [image formats](#) are available here.

## IMAGE FORMATS

The following image formats apply to screenshots/hard copies of the display or the video input.

Input	Definition	Storage space requirement/execution time	requi-
1	BMP 24Bit → True Color	Very high	
2	BMP 16Bit → High Color	High	
3	BMP 8Bit grey → grey-scale image	Low	
11	epg 32Bit → True Color with alpha channel	Very high	
12	epg 16Bit → High Color	High	
13	epg 8Bit grey → grey-scale image	Low	
21	epg 32Bit RLE compressed → see above	High	
22	epg 16Bit RLE compressed → see above	Medium	
23	epg 8Bit grey RLE compressed → see above	Very low	

## POLYLINE AND POLYGONS

With the polyline ([#GPL](#)) and polygon ([#GPF](#)) commands, virtually all desired forms can be generated. Each section is designated a segment.

## SEGMENT

A segment is generally a section or a part of something whole.

In the present command application, the segments fulfil two primary aspects. Firstly, graphics, and, secondly, operational paths, can be created, segment by segment. As a result, freely selectable forms find their way into the design of the layout.

## INDICATORS

Each segment contains an indicator in the form of a character whereby the type of segment is recognised. The list of indicators can be found [here in the command overview](#).

A segment entered always begins with "?", and the indicator, as well as the corresponding parameters, are added subsequently. In that respect, as many segments as desired can be linked with one another. There is furthermore a difference, in the case of the indicators, between upper and lower case, which represents the difference between absolute and relative co-ordinates.

Here is an example:

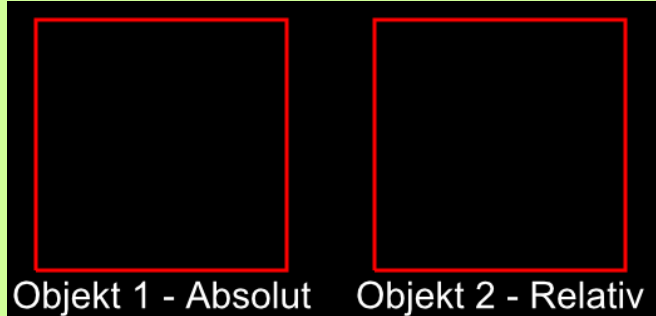
Generating a square with absolute and relative segment details	
<pre>#GPP1, 1, 100, 100, ?V, 300, ?H, 300, ?V, 100, ?H, 100 #GPP2, 1, 370, 100, ?v, 200, ?h, 200, ?v, -200, ?h, -200</pre>	

In this example, two identical squares are generated by linking horizontal and vertical lines. Object 1 is generated absolutely, in other words the absolute co-ordinates of the display need to be specified for positioning the line points. By connecting the point co-ordinates, the corresponding lines are generated from the latter. In the case of Object 2, on the other hand, only the starting point is defined absolutely. In regard to this starting point, the lengths of the respective lines are now specified. Thus, this square relates to the starting point relatively.

## DIRECTIONS OF MOVEMENT AND ARCS

The direction of movement is to be observed with the circular segments. Depending upon the direction of movement, another segment is generated.

In the table below, a segment is defined as a full ellipse, with a starting point and an end point. Due to the radii of the ellipse being given, four options exist for linking the starting point with the end point. The four options differ in regard to the two directions of movement and the two potential arcs. The small arcs are marked red. The two large arcs have been highlighted in green. The clockwise directions of movement are shown darker.

With circles, the differentiation according to large and small arcs does not make a difference. This is due to the fact that a circle only has a radius, as a result of which the large and small arcs are identical.



Highlighting the arcs and directions of movement

#GPP1, 1, 390, 380, ?E0, 200, 70, 25, 340, 260  
#GPP2, 2, 390, 380, ?E1, 200, 70, 25, 340, 260  
#GPP3, 3, 390, 380, ?E2, 200, 70, 25, 340, 260  
#GPP4, 4, 390, 380, ?E3, 200, 70, 25, 340, 260

0: Small anti-clockwise arc  
1: Small clockwise arc  
2: Large anti-clockwise arc  
3: Large clockwise arc

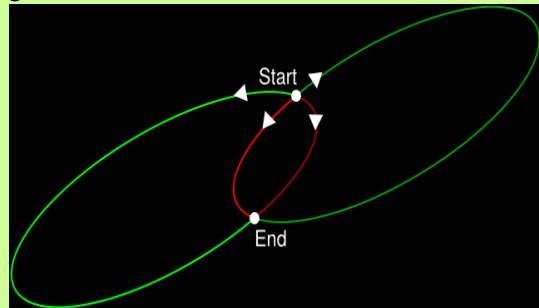

## ANCHOR

All objects can be created at a position (x, y). By specifying the anchor numbers, it can now be determined whether the object is e.g. with the upper left corner (anchor 1), or e.g. exactly in the middle (anchor 5). In the case of multiline texts, there are further anchors (11-19) which refer to the baseline of the text. In the table below, a string is displayed to illustrate the anchors:

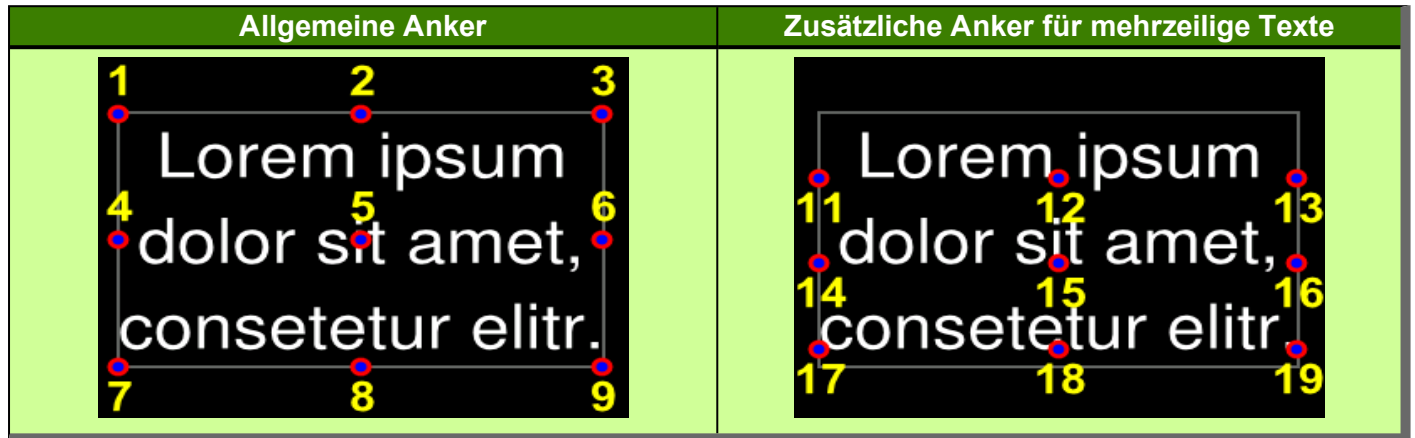

In addition to the above anchor numbers, there is also anchor 0. Anchor 0 is a special anchor, which can be arbitrarily set by corresponding commands. Thus, for example, an object is able to rotate around a desired point. In the following example, a round thermometer is shown:



The pointer should turn around the center of the instrument. With the general anchors, which are represented as small gray squares, the pointer can also rotate around the center of the thermometer. The standard anchors 1 to 9 are not suitable for this purpose. Therefore, in this case, an individual anchor 0 is determined. This can be determined by pixel accuracy and is shown in red in the image. The pointer is now rotated around this anchor point.

## **GROUPS**

Groups simplify the simultaneous handling of several objects. The desired objects are grouped together in an object group, but they retain their individual functions and definitions. The advantage is that all objects of the group can be affected at the same time, for example a shift, a rotation or a fade-out. In addition to the simple object groups, there are also groups for touch switches. These ensure that only one switch of the group is active (radio buttons), which means that not every switch has to be defined individually with such a function.

**Attention:** Group IDs and object IDs are in the same number space and thus overwrite each other.

## CALCULATION

Each numerical parameter can be replaced by a calculation. The calculation needs to be enclosed in brackets ().

Name	Command	Description	Integer	Float
Mathematical functions	+, -, *, /, ()	Arithmetical functions	✓	✓
x  (amount)	abs(x)	Calculation of absolute value	✓	✓
x%y (modulo)	mod(x,y)	Calculation with remainder	✓	
x^y (power)	pow(x,y)	Calculation with power	✓	✓
Root	sqrt(var)	Calculating the root		✓
Logarithm	log(var)	Calculating the logarithm		✓
Natural logarithm	ln(var)	Calculating the natural logarithm		✓
Degrees to radians	rad(deg)	Converting degrees to radians		✓
Radians to degrees	deg(rad)	Converting radians to degrees		✓
Sine	sin(deg)	Calculating the sine		✓
Cosine	cos(deg)	Calculating the cosine		✓
Tangent	tan(deg)	Calculating the tangent		✓
Arc sine	asin(var)	Calculating the arc sine		✓
Arc cosine	acos(var)	Calculating the arc cosine		✓
Arc tangent	atan(var)	Calculating the arc tangent		✓
Arc tangent in the correct quadrant	atan(y,x)	Calculating the arc tangent in the correct quadrant		✓
Random value in the range	rand(sv,ev)	Random value in the range of values	✓	✓
Random value 0 - ev	rand(ev)	Random value greater than 0	✓	✓
Random value 0<= x<=1000	rand()	Random value greater than 0; smaller than 1000	✓	✓
Minima	min(a,b,c...)	Smallest value	✓	✓
Maxima	max(a,b,c...)	Largest value	✓	✓
Average	avg(a,b,c...)	Average	✓	✓
Bit operators	<<, >>, &,  , ^, ~	Bit Operatoren	✓	
Logical operators	<, >, <=, >=, !=, ==, &&,   , !	Logical operators	✓	✓
Increase, reduce	++,--	Increase, reduce	✓	✓
Port (a=0..15) = 0..255	port(a)	Port value	✓	✓

Name	Command	Description	Integer	Float
Portbit (a=0..127) = 0/1	bit(a)	Bit value	✓	✓
Analogport (a=0..3) = 0..4095	analog(a)	Analogue port value	✓	✓
Current date in seconds	date()	Current date	✓	
Day in seconds	date(D)	Current day	✓	
Day + month + year (1932 - 2067) in seconds	date(D,M,Y)	Any date desired	✓	
Current time in seconds	time()	Current time	✓	
Hour to seconds	time(h)	Current hour	✓	
Hour + mins to seconds	time(h, m)	Current hour and minute	✓	
Hour + min. + sec. in seconds	time(h, m, s)	Current hour, minute and second	✓	
Current time and date	datetime()	Current date with time	✓	
Hour +min.+sec. + Day+month+year to seconds	datetime(h,m,s,D,M,Y)	Any desired date and time specification	✓	
Current year	year()	Current year	✓	
Seconds as from 01/01/2000, 0:00:00 to year	year(a)	Save year	✓	
Current month	month()	Current month	✓	
Seconds as from 01/01/2000, 0:00:00 to month	month(a)	Save month	✓	
Current day	day()	current day	✓	
Seconds as from 01/01/2000, 0:00:00 to days	day(a)	save day	✓	
Current weekday (0=Sunday)	weekday()	Current weekday	✓	
Seconds as from 01/01/2000, 0:00:00 to weekday	weekday(a)	Save weekday	✓	
Current hour	hour()	Current hour	✓	
Seconds as from 01/01/2000, 0:00:00 to hours	hour(a)	Save hour	✓	
Current minute	minute()	Current minute	✓	
Seconds as from 01/01/2000, 0:00:00 to minutes	minute(a)	Save minute	✓	
Current second	second()	Current second	✓	
Seconds as from 01/01/2000, 0:00:00 to seconds	second(a)	Save second	✓	
Global 10 ms timer	timer()	Global timepiece 10ms	✓	
24-bit colour red channel	getR(x)	Determine colour portion red	✓	

Name	Command	Description	Integer	Float
24-bit colour green channel	getG(x)	Determine colour portion green	✓	
24-bit colour blue channel	getB(x)	Determine colour portion blue	✓	
24-bit colour RGB	RGB(R, G, B)	Determine colour completely	✓	
Displays RGB of ramp number	rampRGB(nr, offset)	Displays colour of colour gradient	✓	✓
Displays transparency of ramp number	rampO(nr, offset)	Displays transparency of colour gradient	✓	✓
Display width	scrW()	Width of the display	✓	✓
Display height	scrH()	Height of the display	✓	✓
Video width	vidW()	Width of the video	✓	✓
Video height	vidH()	Height of the video	✓	✓
Number of video objects	vidC()	Number of video objects	✓	✓
Object width (without transformation)	objW(id)	Width of the object	✓	✓
Object height (without transformation)	objH(id)	Height of the object	✓	✓
Object position x of the current anchor	objX(id)	X position of the object	✓	✓
Object position x of any desired anchor	objX(id, anchor)	X position of the object		
Object position Y of the current anchor	objY(id)	Y position of the object	✓	✓
Object position Y of any desired anchor	objY(id, anchor)	Y position of the object		
Object scaling, width	objSW(id)	Scaling of the object width	✓	✓
Object scaling, height	objSH(id)	Scaling of the object height	✓	✓
Object shearing X	objSX(id)	Shearing in the X direction of the object	✓	✓
Object shearing Y	objSY(id)	Shearing in the Y direction of the object	✓	✓
Object rotation	objR(id)	Rotation of the object	✓	✓
Object opacity	objO(id)	Transparenz des Objekts	✓	✓
Object level	objL(id)	Ebene des Objekts	✓	✓
Object Style Number	objC(id)	Style Nummer der Objekts	✓	✓
Current object anchor	objA(id)	Current anchor of the object	✓	✓
Instrument bar of current value	objIV(id)	Current instrument value	✓	✓

Name	Command	Description	Integer	Float
Instrument bar of drawn value	objID(id)	Drawn instrument value	✓	✓
Instrument bar of end value	objE(id)	End value of the instrument	✓	✓
Instrument bar start value	objS(id)	Start value of the instrument	✓	✓
Displays the length of the action path	pathL(id)	Länge des Aktionspfades	✓	✓
Displays relative X co-ordinates from the beginning of the action path	pathX(id,distance)	X position beginning of path	✓	✓
Displays relative Y co-ordinates from the beginning of the action path	pathY(id,distance)	Y position beginning of path	✓	✓
Displays the angle of the tangent of the action path	pathR(id,distance)	Tangential angle of the path	✓	✓
Displays touch button/switch status	butS(id)	Status button or switch	✓	✓
Displays the active touch switch of the radio group	butR(groupid)	Active switch in group	✓	✓
Displays last key/switch pressed	butI()	Last switch pressed	✓	✓
Displays code of the last keyboard keys	butC()	Last key pressed on the keyboard	✓	✓
Displays the length of the string	strL(nr)	Length of the string	✓	
Displays ASCII code from string registers	strA(nr, pos)	ASCII code of the stored string	✓	
Displays Unicode from string register	strU(nr, pos)	Unicode of the stored string	✓	
Comparison between two string registers	strC(n1, n2)	Compare string registers	✓	
Convert numerical string into value	strV(nr)	Convert numerical string into value described	✓	✓
Checks whether file exists (<name> in String Register No.)	fileE(nr)	Check existence of the file in the string register	✓	
Gibt Dateigröße aus (<name> in Stringregister nr)	fileS(nr)	Check size of the file in the string register	✓	
Displays file size (<name> in String Register No.)	fileT(nr)	Zeit der Datei im Stringregister prüfen	✓	
Gibt Dateieigenschaft aus(<name> in Stringregister nr)	fileA(nr)	Eigenschaft der Datei im Stringregister prüfen	✓	
Displays file time (<name> in String Register No.)	fileD(nr)	Daum der Datei im Stringregister prüfen	✓	
Seconds in FatTime, 16-bit	fatT(Sekunde)		✓	
Seconds in FatDate, 16-bit	FatD(Sekunde)		✓	
Display integer calculation as a float	int(calculation)	Integer value from float calculation		✓

Name	Command	Description	Integer	Float
Display float calculation as an integer	float(calculation)	Float value from integer calculation	✓	



## **ACTION AND ANIMATION**

Actions and animations can be used to "bring life" to objects or graphics on the display. There are significant differences between an action and an animation.

### **ACTION**

[Actions](#) are used to change objects. For example, objects can be moved or their transparency can be changed. Accordingly, an apparent or vanishing [behaviour](#) can also be defined. If an action affects the parameters of an object, they remain on the newly assigned value.

This means, for example, if an object should disappear, it is deleted at the end of the action. By changing the position in combination with the [actions paths](#), actions also allow you to follow a defined path. Action paths have the advantage that objects can rotate, scale, position, or change their percentages as a percentage. The action sequence can be adapted via the [action curves](#). For example, a linear sequence or a process with delay or acceleration are already available as templates.

### **ANIMATION**

Animations are only valid for GIF files as well as for color fills and line patterns. The various [animation types](#) can be used to influence the image sequence of GIFs or to animate line patterns and color fillings of graphics. For the time sequence of the animation, the [action curves](#) can be used for better adaptation, as already described for the actions.

## **SAFETY INSTRUCTIONS**

### **AVOID ELECTRIC SHOCK AND FIRE**

- Do not use a damaged power cord or plug.
- Do not use loose sockets.
- Do not touch the power cord with wet hands.
- Do not unplug the power cord by pulling the cord.
- Do not bend or damage the power cord

### **CARE AND USE**

Keep the unit dry.

- Moisture and liquids of all types can damage parts of the device or electronic circuits.

Do not store the unit in dusty or dirty environment.

- Dust can cause malfunction of the unit.

Do not place the unit on inclined surfaces.

- The unit can be damaged by falling down.
- Do not place the unit near magnetic fields, as this can cause malfunction of the unit.

Do not drop or subject the unit to shocks.

## EA uniTFT Vorläufig

---

- The screen of the unit may be damaged.
- Bending or deforming can damage both the device and parts thereof.

Only use approved original spare parts.

Do not use the unit when the display is cracked or broken.

Do not use the appliance for purposes other than those intended.

Handle memory cards with care.

- Do not remove a memory card from the device while data is being read or stored on the card. Failure to do so may result in data loss or damage to the card or device.
- Do not touch the gold-colored contacts of memory cards with your fingers or metallic objects. If the contacts are dirty, clean them with a soft cloth.

Clean the device without chemicals or solvents and use a clean cloth.

**HARDWARE**
**PIN ASSIGNMENT**

An overview on the pin assignment of the display is shown below.

Pin	Symbol	I/O	Beschreibung	Pin	Symbol	I/O	Beschreibung
1	GND		Ground 0 V	27	I/O 1.7 I/O SDA	I/O I/O	Input/Output 1.7 (Bit 15) Port Expander Serial Data
2	VDD		Power Supply 3,3 V	28	I/O 1.6 I/O SCL	I/O I/O	Input/Output 1.6 (Bit 14) Port Expander Serial Clock
3		I	!Reset	29	I/O 1.5 I/O INT	I/O I/O	Input/Output 1.5 (Bit 13) Port Expander Interrupt
4	SPI CS	I	SPI: Chip select	30	I/O 1.4	I/O	Input/Output 1.4 (Bit 12)
5	SPI MOSI	I	SPI: Serial in	31	I/O 1.3	I/O	Input/Output 1.3 (Bit 11)
6	SPI MISO	O	SPI: Serial Out	32	I/O 1.2	I/O	Input/Output 1.2 (Bit 10)
7	SPI CLK	I	SPI: Serial Clock	33	I/O 1.1	I/O	Input/Output 1.1 (Bit 9)
8	RS232 RxD	I	RS232: Receive Data	34	I/O 1.0	I/O	Input/Output 1.0 (Bit 8)
9	RS232 TxD	O	RS232: Transmit Data	35	I/O 0.7	I/O	Input/Output 0.7 (Bit 7)
10	DE (RS485)	O	RS232: Transmit Enable RS485	36	I/O 0.6	I/O	Input/Output 0.6 (Bit 6)
11	I <sup>2</sup> C SDA	I/O	I <sup>2</sup> C: Serial Data	37	I/O 0.5	I/O	Input/Output 0.5 (Bit 5)
12	I <sup>2</sup> C SCL	I	I <sup>2</sup> C: Clock Data	38	I/O 0.4	I/O	Input/Output 0.4 (Bit 4)
13	A/D 0	I	Analogeingang 0	39	I/O 0.3	I/O	Input/Output 0.3 (Bit 3)
14	USB DPn	I/O	USB Data negative	40	I/O 0.2	I/O	Input/Output 0.3 (Bit 2)
15	A/D 1	I	Analogeingang 1	41	A/D 3	I	Analogeingang 3
16	USB DPp	I/O	USB Data positive	42	A/D 2	I	Analogeingang 2
17	I/O 0.0	I/O	Input/Output 0.0 (Bit 0)	43	I <sup>2</sup> C SCL	I	User I <sup>2</sup> C: Clock Data
18	USB VBus		USB Supply Voltage	44	I <sup>2</sup> C SDA	I/O	User I <sup>2</sup> C: Serial Data
19	I/O 0.1	I/O	Input/Output 0.1 (Bit 1)	45	RS232 TxD	I	User RS232: Transmit Data
20	Testmode SBUF	I O	PowerOn low: Testmode low: Data available in sendbuffer	46	RS232 RxD	O	User RS232: Receive Data
21	PWM	O	PWM output	47	SPI CLK	O	User SPI: Serial Clock
22	DPROT	I	open (high): Protocoll active low: Protokoll deaktiviert	48	SPI MISO	I	User SPI: Serial In
23	SND+	O	Loudspeaker Output (8 Ohm)	49	SPI MOSI	O	User SPI: Serial Out
24	SND-	O	Loudspeaker Output (8 Ohm)	50	SPI CS	O	User SPI: Chip select
25	VDD		Power Supply 3,3 V	51	VIN		Power Supply 3,3 V
26	GND		Ground 0 V	52	GND		Ground 0 V

## RS232

RS232 is a standard for a serial interface. Data is transmitted serially in an asynchronous manner. The data is thus converted into a bit stream and transmitted. No common clock line exists. In other words, every bus subscriber needs to work with the same transmission rate (the so-called "baud rate"). RS232 is a voltage interface. That means that the data is transmitted via a voltage level. In the PC world and industrial control systems, levels of +12V or -12V are defined as the standard. Within PCBs or in micro-controllers, it is usual to work with 0V or VDD (in the case of the EA uniTFT050 3.3 V). To adjust the signal level, there are one or two options in the form of level shifters. RS232 consists of "hearing" and "speaking" lines which are crossed between the two subscribers.

## DATA FORMAT

The format for the data transmission is 8-N-1:

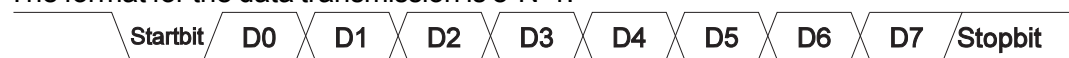

## BAUD RATES

The baud rate is preset to 115.200 baud in the delivery state. The command [Beispiel siehe S. 97](#) can change the baud rates. Alternatively you can set this command also in the file <start.emc>.

Baudrates	Error rate in %
9600	+0,04
19200	-0,08
38400	+0,16
57600	-0,08
115200	+0,64
230400	-0,80
460800	+2,08
921600	-3,68

APPLICATION EXAMPLES

RS232 V24 - CONNECTION TO A PC

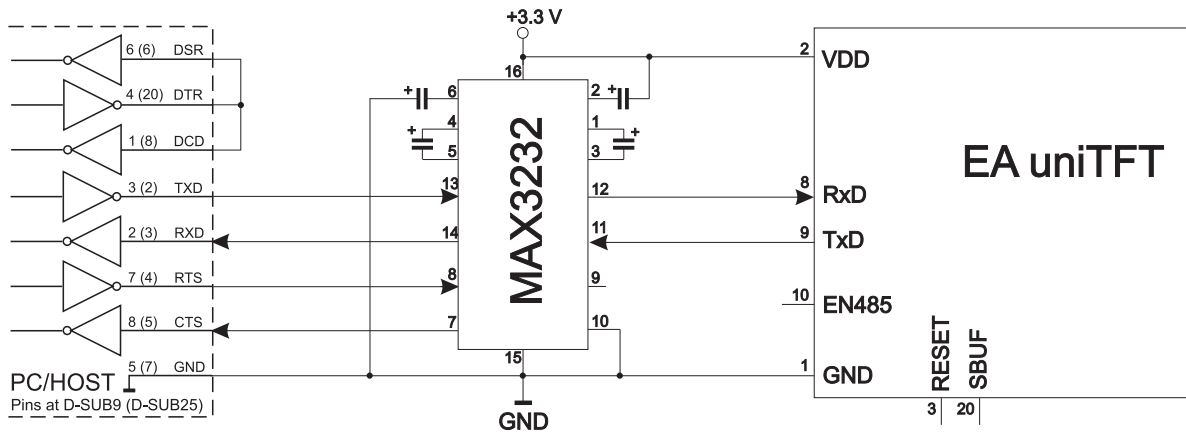

RS485 - BUS SYSTEM

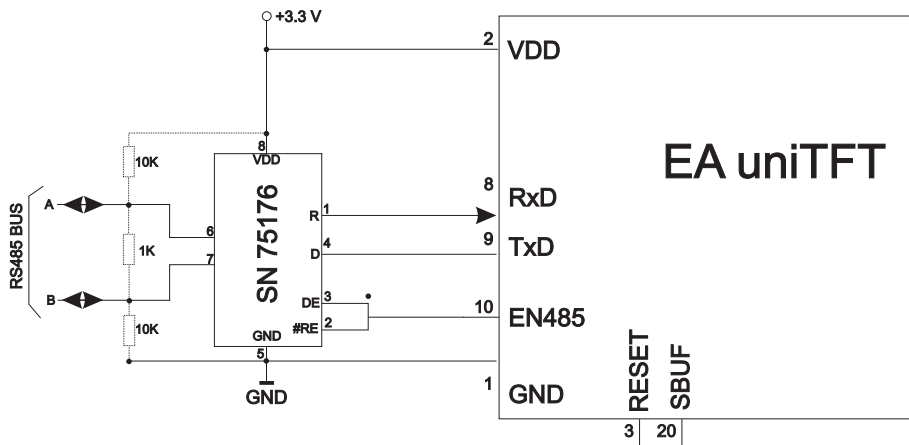

## SPI

Das **S**erial **P**eripheral **I**nterface is a bus system for a serial synchronous data transmission between various ICs. The bus consists of the following lines:

- MOSI (**M**aster **O**ut → **S**lave **I**n) otherwise known as SDO (Serial Data Out) or DO
- MISO (**M**aster **I**n ← **S**lave **O**ut) also known as SDI (Serial Data In) or DI
- SCK (**S**erial **C**lock) - shift clock
- SS (**S**lave **S**elect → Addressing the partner), also known as CS (Chip Select)

SPI works with a bidirectional transmission principle, i.e. data is exchanged between the partners simultaneously. Every communication is determined by the master with the aid of the SCK line. The display works in the slave mode.

The log for the data transmission is not laid down with SPI, so that there are various configuration options. These are laid down by the parameters of clock polarity, clock phase and data order:

The SPI-Mode 3 with DORD=0 is preset. The command [Beispiel siehe S. 97](#) can change the modes 0..3. Alternatively you can set this command also in the file <start.emc>.

	CPO- L Mo- de	CPH- A (Clo- ck Pola- rity)	DORD(0) MSB first	DORD(1) LSB first
0	Low (0)	steigende Flanke (0)	<p>SPI-Mode: 0 CPOL=0 (CLK idle state LOW) CPHA=0 (data valid at first edge) DORD=0 (MSB=send BIT7 first)</p>	<p>SPI-Mode: 0 CPOL=0 (CLK idle state LOW) CPHA=0 (data valid at first edge) DORD=1 (LSB=send BIT0 first)</p>
1	Low (0)	fallende Flanke (1)	<p>SPI-Mode: 1 CPOL=0 (CLK idle state LOW) CPHA=1 (data valid at second edge) DORD=0 (MSB=send BIT7 first)</p>	<p>SPI-Mode: 1 CPOL=0 (CLK idle state LOW) CPHA=1 (data valid at second edge) DORD=1 (LSB=send BIT0 first)</p>
2	High (1)	fallende Flanke (0)	<p>SPI-Mode: 2 CPOL=1 (CLK idle state HIGH) CPHA=0 (data valid at first edge) DORD=0 (MSB=send BIT7 first)</p>	<p>SPI-Mode: 2 CPOL=1 (CLK idle state HIGH) CPHA=0 (data valid at first edge) DORD=1 (LSB=send BIT0 first)</p>
3	High (1)	steigende Flanke (1)	<p>SPI-Mode: 3 CPOL=1 (CLK idle state HIGH) CPHA=1 (data valid at second edge) DORD=0 (MSB=send BIT7 first)</p>	<p>SPI-Mode: 3 CPOL=1 (CLK idle state HIGH) CPHA=1 (data valid at second edge) DORD=1 (LSB=send BIT0 first)</p>

## I<sup>2</sup>C

I<sup>2</sup>C stands Inter-Integrated Circuit and is a serial data bus developed by Phillips. The bus designed as a master-slave bus requires 2 signal lines:

- SCL (Serial Clock Line)
- SDA (Serial Data Line)

The electrical specification provides that both lines are terminated with a pull-up resistor to VDD, since all devices connected to the bus have open-collector outputs. The bus clock is always specified by the master, which determines the entire communication:

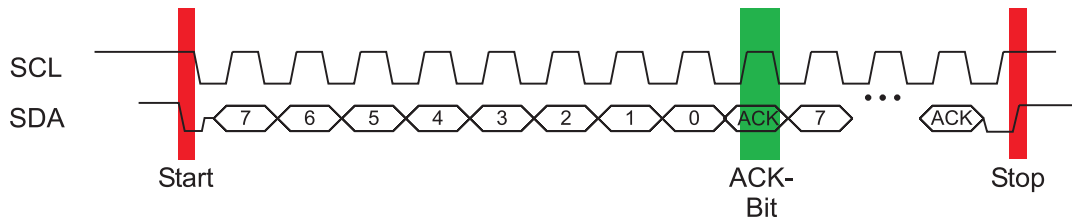

After the start condition, the slave address always follows in the transmission protocol. Bit 0 is the so-called R/W bit and determines whether the slave should read (1) or transmit data (0). The data is exchanged until the master executes the stop condition. More detailed information can be found in the I<sup>2</sup>C specification. The display operates in slave mode.

The default I<sup>2</sup>C bus address is 0xDE (depending on the notation, 0x6F). The command [Beispiel siehe S. 97](#) can be used to re-define an x-like other address. Alternatively, this can be done via the <start.emc> file.



## USB

Der **U**niversal **S**erial **B**us is a serial bus system for connecting with a computer or other device. It is based on differential data transmission. The bus topology is a strict master/slave communication (exception: "On the Go" devices). In the case of the EA uniTFT050, it is always the PC/Master which has to lead the communication. The module has a CDC device class and thus connects to the PC as a virtual serial COM interface:

Description	Value
Device class	2
USB Vendor ID	0x2DA9
USB Product ID	0x2454
Gerätebeschreibung	EA uniTFT

Um Einstellungen am Display vorzunehmen oder für erste Tests empfehlen wir die USB-Schnittstelle. Sie ist einfach anzuschliessen und es müssen keine Schnittstellenparameter angepasst werden.

## SD CARD

The module has a removable micro SD card (up to 32GB). The micro SD card must be formatted with FAT32.



The memory is used for all project data, e.g. Different styles, objects, and images. The memory may additionally be used e.g. for data log functions at runtime.

## VIDEO INPUT/CAMERA

The module has an analogue video input and supports three colour systems: **PAL** (**P**hase **A**lternating **L**ine), **Secam** (**S**équentiel couleur à mémoire) and **NTSC** (**N**ational **T**elevision **S**ystems **C**ommittee). The module automatically selects the right colour system settings.

Most digital cameras and video cameras come with a suitable interface, just as most CMOS cameras do. The resolution is limited to 720x576 (PAL and SECAM), 640x480 (NTSC) pixels. The input is also referred to as a composite video signal input.

he two connections (gold-plated solder pads) are located next to pin 27 ([see Dimensions](#)). The input levels are 3.3V compatible.

**ANALOGUE INPUT**

The module has 4 analog inputs with a resolution of 12 bits. The values can be used for further processing. The crossing or subtraction of a boundary region can also trigger an alarm.

Measuring range: 0V to 3.3 V. The supply voltage is used as reference input for the ADC.

## **PULSE WIDTH MODULATION (PWM)**

The module has the possibility to control external components via a PWM signal (pulse width modulation). The duty ratio of the rectangular pulse is changed at a constant frequency (adjustable from 2 Hz to 1 MHz with the command [Beispiel siehe S. 91](#)). The duty ratio between on / off time can be changed, too. Electromechanical components, e.g. Motors or a quasi-analog voltage can be driven and generated. The variation of the duty cycle then ensures low motor speed / voltage with a short on-time or a high motor speed / voltage with a long on-time. The output levels are 0V and 3.3V.

## EA uniTFT Vorläufig

### INPUT/OUTPUT (I/O)

The module has 16 digital I/O's build in.

The input voltage range is between 0..3,3V. All 16 I/O's are configured as 100kOhm Weak Pull-up at start up.

Through the use of one or more external port-expanders MCP23017 (16 I/O for each IC) the number of the entire I/O can be extended up to 128-3. For this purpose, the ports "I/O 1.5 to 1.7" (pin 27 to 29) are switched over and used as serial data lines for the Portexpanders (see application example). This is done by soldering 3 resistors:

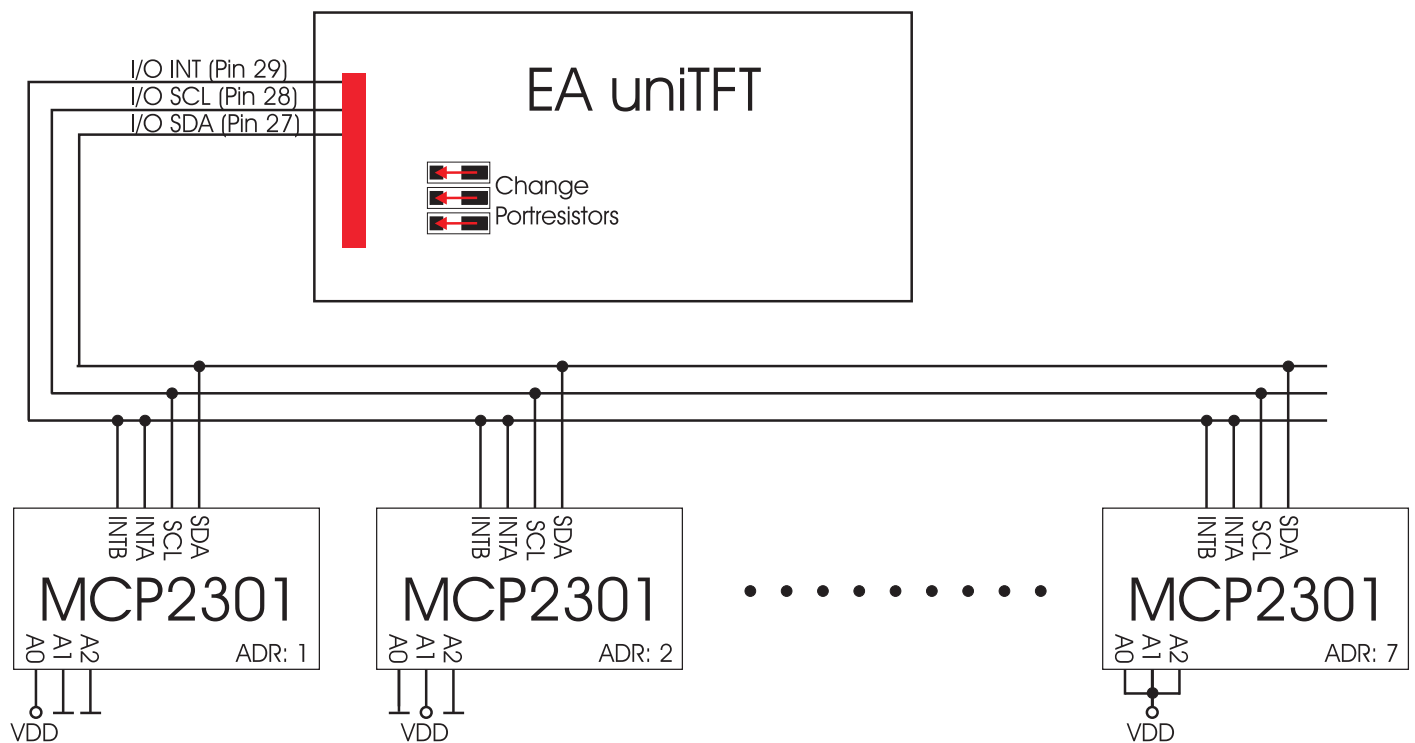

The maximum output of the component is 700mW. The maximum current load for a single pin is 25mA.

## SHORT PROTOCOL & SMALL PROTOCOL

In order to ensure secure data transmission, 2 differently complex transmission protocols are integrated. In both protocols, the user data is embedded into a packet by adding a start and a final sequence. We recommend to use the short protocol, but for compatibility with the EA eDIPxxx series you can continue with the small protocol.

For initial tests on the serial interface, the protocol can also be switched off completely (Pin 22 "DPROT" to low).

Both protocols are independent of the interface RS-232, SPI, I<sup>2</sup>C or USB used. The data transmission is embedded in a fixed frame with checksum. The module acknowledges this package with the character <ACK> (= \$ 06) on successful reception or <NAK> (= \$ 15) if the checksum is incorrect or receive buffer is overflowed. In either case, after received <NAK> the complete package is discarded and must be sent again.

**Note:** The <ACK> must be actively read SPI and I<sup>2</sup>C). If the host does not receive an acknowledgment, at least one byte has been lost. In this case, the timeout time must be waited before the packet is completely repeated. The number (len) of the user data per packet can be max.2042 Byte. Commands larger than 2042 byte (for example, images or file #FWD ...) must be split into several packages. The user data in the individual packets are reassembled after correct reception

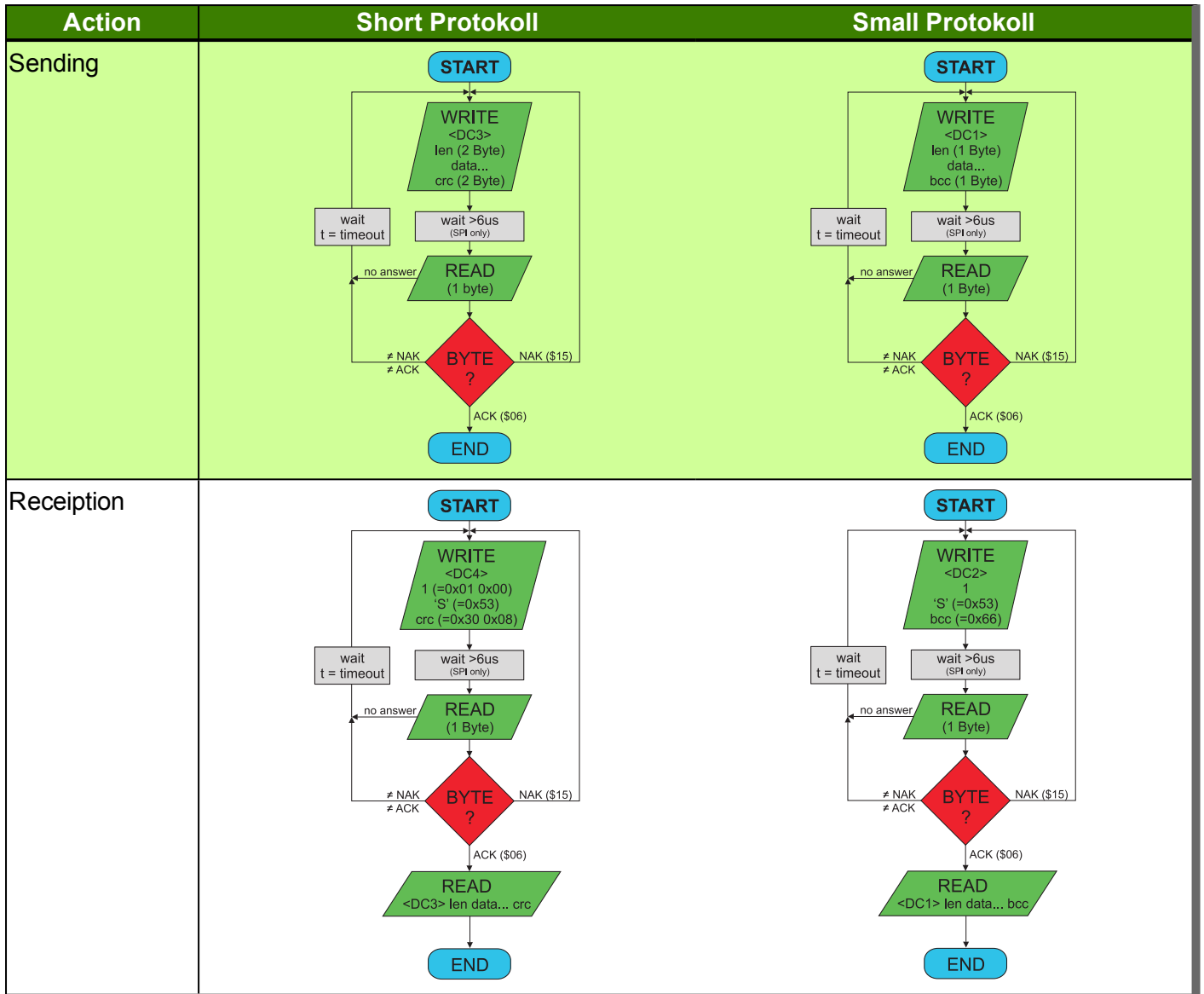

SHORT PROTOCOL

Command	Display	Byte										
		0	1	2	3	4	5	6	7	8	9	10
Send commands / data to display	send	DC3 <sup>1</sup>	len <sup>2</sup>		data	...	...	crc16 <sup>3</sup>				
	receive	ACK										
Repeat last packet	send	DC4	1	0	'S'	crc16						
	send	ACK										
	receive	DC3	len		data	...	...	crc16				
Request protocol information	send	DC4	1	0	'R'	crc16						
	send	ACK										
	receive	DC3	len		data	...	...	crc16				
Request / Release interface	send	DC4	5	0	'D'	packet size sendbuffer <sup>4</sup>		timeout <sup>5</sup> [10 ms]		crc16		
	receive	ACK										
Hardware Reset / Reboot	send	DC4	1	0	'I'	crc16						
	send	ACK										
	receive	DC4	4	0	Sendbuffer bytes ready			Receivebuffer bytes free		crc16		
Repeat last packet	send	DC4	1	0	'P'	crc16						
	send	ACK										
	receive	DC4	6	0	max. Packet size		akt. Packetsize		timeout [10 ms]		crc16	
Request protocol information	send	DC4	3	0	'A'	Select / Deselect	adr	crc16				
	receive	ACK										
RS485 direction enable delay	send	DC4	2	0	'T'	Verzögerung [10 us] <sup>6</sup>						
	receive	ACK										
Break-command	send	DC4	2	0	'G'	0=Freigabe 1=Anfordern		crc16				
	send	ACK										
	receive	DC4	1	0	aktiv <sup>7</sup>	crc16						
Call the display's send buffer	send	DC4	2	0	'C'	mask <sup>8</sup>		crc16				
	receive	ACK										
Protocol settings	Display	DC4	2	0	'B'	option <sup>9</sup>		crc16				

<sup>1</sup>DC3 = 19d = 0x13; DC4 = 20d = 0x14

<sup>2</sup>len: number of use data, without checksum, without DC3/4. Consists of 2 bytes, low byte is transmitted first



## EA uniTFT Vorläufig

---

<sup>3</sup>crc: Checksum over all transmitted bytes, including DC3/4 and length bytes. CRC16-CCITT's start value is 0xFFFF. Low byte is transmitted first

<sup>4</sup>Maximum buffer size is 2042

<sup>5</sup>Delay in [10ms] till deletion of data packet. The default is 200 = 2 seconds.

<sup>6</sup>Delay in [10us] till EA uniTFT RS485-direction is altered. Default is 0 = immediately.

<sup>7</sup>active: 0=ALLE, 1=RS232, 2=SPI, 3=I<sup>2</sup>C, 4=USB

<sup>8</sup>mask: 1=break wait-command (#XXW), 2=actual macros, 4=Clear send buffer, 8=Clear receive buffer. The individual bits can be OR-combined.

<sup>9</sup>option: 1=Testmode, 2=Disable PowerOnMacro, 3=Disable defaults 4=Boot menu

**SMALL PROTOCOLL**

Command	Display	Byte					
		0	1	2	3	4	5
Send commands / data to display	receive	DC1 <sup>1</sup>	len <sup>2</sup>	data	...	...	bcc <sup>3</sup>
	send	ACK					
Call the display's send buffer	receive	DC2	1	'S'	bcc		
	send	ACK					
	send	DC1	len	data	...	...	bcc
Repeat last packet	receive	DC2	1	'R'	bcc		
	send	ACK					
	send	DC1	len	data	...	...	bcc
Protocoll settings	receive	DC2	3	'D'	packet size send-buffer <sup>4</sup>	timeout <sup>5</sup> [10 ms]	bcc
	send	ACK					
Request buffer information	receive	DC2	1	'I'	bcc		
	send	ACK					
	send	DC2	2	Sendbuffer bytes ready	Receivebuffer bytes free	bcc	
Request protocoll information	receive	DC2	1	'P'	bcc		
	send	ACK					
	send	DC2	3	max. Packet size	akt. Packetsize	timeout [10 ms]	bcc
Adressing RS485	receive	DC2	3	'A'	Select / Deselect	adr	bcc
	send	ACK					
RS485 direction enable delay	receive	DC4	2	'T'	Verzögerung [10 us] <sup>6</sup>		
	send	ACK					
Request / Release interface	receive	DC2	1	'G'	0=Freigabe 1=Anfordern		
	send	ACK					
	send	DC2	1	aktiv <sup>7</sup>	bcc		
Break-command	receive	DC2	1	'C'	mask <sup>8</sup>		
	send	ACK					
Hardware Reset / Reboot	receive	DC2	1	'B'	option <sup>9</sup>	bcc	

<sup>1</sup>DC1 = 17d = 0x11; DC2 = 18d = 0x12

<sup>2</sup>len: number of use data, without checksum, without DC1/2.

<sup>3</sup>bcc: Sum of all bytes including DC1 / 2 and length (Modulo 256)

<sup>4</sup>The maximum buffer size is 255

<sup>5</sup>Delay in [10ms] till deletion of data packet. The default is 200 = 2 seconds.

## EA uniTFT Vorläufig

<sup>6</sup>Delay in [10us] till EA uniTFT RS485-direction is altered. Default is 0 = immediately.

<sup>7</sup>active: 0=ALLE, 1=RS232, 2=SPI, 3=I<sup>2</sup>C, 4=USB

<sup>8</sup>mask: 1=break wait-command (#XXW), 2=actual macros, 4=Clear send buffer, 8=Clear receive buffer. The individual bits can be OR-combined.

<sup>9</sup>option: 1=Testmode, 2=Disable PowerOnMacro, 3=Disable defaults 4=Boot menu

### CHECKSUM CALCULATION

In the following two sample functions, checksum calculation for Short or Small protocol, are shown.

#### SHORT PROTOCOLL

A cyclic redundancy check (CRC) is used to calculate the checksum. A common and well-known CRC test is the CRC-CCITT. The initial value 0xFFFF is used. The following is a typical C-implementation. The functions must be called externally. The checksum must be pre-assigned with the start value.

```
//-----  
-  
//Function: buffer2crc16()  
//input: ptr data, ptr to CRC, len  
//output: ---  
//Descr: CRC-CCITT of a buffer  
//-----  
-  
void buffer2crc16(UBYTE *dat, UINT16 *pCRC, UINT32 anz)  
{  
    while(anz--)  
        crc16(*dat++, pCRC);  
}  
  
//-----  
-  
//Function: sp_crc16()  
//input: data, ptr to CRC  
//output: ---  
//Descr: CRC_CCITT (x16+x12+x5+1 = 1 0001 0000 001>0 0001 = 0x1021  
//-----  
-  
void crc16 (UBYTE dat, volatile UINT16 * crc)  
{  
    register UINT16 lcrc = *crc;  
  
    lcrc = (lcrc >> 8) | (lcrc << 8);  
    lcrc ^= dat;  
    lcrc ^= (lcrc & 0xFF) >> 4;  
    lcrc ^= lcrc << 12;  
    lcrc ^= (lcrc & 0xFF) << 5;  
  
    *crc = lcrc;  
}
```

**SMALL PROTOCOLL**

For the calculation of the checksum, a simple 8-bit sum check (modulo 256) is performed for this protocol type.

```
//-----  
-  
//Function: buffer2bcc()  
//input: ptr data, len  
//output: ---  
//Descr: Byte bcc of a buffer  
//-----  
-  
UBYTE buffer2bcc(UBYTE *dat, UBYTE anz)  
{  
    UBYTE bcc = 0;  
    while(anz--)  
        bcc += *dat++;  
  
    return bcc;  
}
```

## COMMANDS

### COMMAND OVERVIEW

The module is controlled by a series of graphic commands. They allow the creation of a screen as a macro as well as via the serial interfaces. The following tables explain each command with the necessary and optional parameters.

### TERMINAL

Parameters that are written in **GREY** in the command tables are considered optional details, and partially have default values. The default values are given in brackets behind the corresponding parameters. Parameters written in **BLACK** on the other hand, must be assigned values. Commands that may contribute towards changing parameters can only be used if the corresponding parameters have already previously been defined. Some commands allow for entering several object IDs. Should these objects be in numerical sequence, the range may be specified with the "-" sign, e.g. 1-5, instead of 1,2,3,4,5.

Designition	Command code	Description
Define window and font	<b>#YDW</b> PosX(old Pos), PosY(old Pos), Anchor (7), Columns(scrW()/Font width), Rows(scrH()/Font height), Font-nr(2)	Defines the terminal window through the font <b>Font No.</b> (1=8x8;2=8x16), number of columns <b>Columns</b> , number of rows <b>Rows</b> , position <b>PosX</b> , <b>PosY</b> and <b>anchor Anchor</b> . After performing the reset, the position in the lower left corner is (0,0), the anchor stands at 7. Should the position not be additionally specified when the window is re-defined, the latter is retained. <a href="#">Beispiel siehe S. 121</a>
Set colour	<b>#YDC</b> Text- <b>RGB</b> , Text- <b>Opacity</b> (100), <b>Background-<b>RGB</b></b> (0x00000000), <b>Background-<b>Opacity</b></b> (0)	Defines the colour of the terminal window in regard to colour and transparency of text <b>Text RGB</b> (e.g. \$FF0000 for red <b>Text Opacity</b> and background <b>Background RGB</b> , <b>Background Opacity</b> . <a href="#">Beispiel siehe S. 121</a>
Terminal level	<b>#YDL</b> Layer	Select the terminal layer, Select the terminal layer, Layer (0= Behind; 1= In front) (0= Behind; 1= In front)
Terminal on/off	<b>#YDO</b> On/Off, <b>Visibility</b> (=On/Off)	The parameter <b>On/Off</b> (0=Off; 1=On) determines whether the terminal window is switched on or off. In the switched-on state, the output is saved, however may be hidden through <b>Visibility</b> (0= Invisible; 1= Visible), as well as made visible again, if required.
Cursors blink on/off	<b>#YCB</b> Cursor	Determine the blinking of the cursor. <b>Cursor</b> 0=off; 1=on
Position cursor	<b>#YCP</b> Column, Row(keine Änderung)	Positions the cursor of the terminal window based on the column <b>Column</b> , and row <b>Row</b> .
Save cursor position	<b>#YCS</b>	<b>Speichert die aktuelle Cursorposition.</b>
Restore cursor position	<b>#YCR</b>	Restores the cursor position saved.

Designation	Command code	Description
Display string	#YPA 'String'	Displays the character string ' <b>String</b> ' in the terminal window. This command may, for example, be used in the output of the <a href="#">Stringregister</a> .
Clear terminal	0x12(FF, Formfeed)	Clears the terminal and puts the cursor in the top left corner.
Show time/date	#YPD DateFormat(#WDF), Date32(actual time)	Displays the time in the terminal window. The display can be changed through the date format DateFormat, as well as its content be overwritten by changing the time and the date <b>Date32</b> . Information on DateFormat can be found <a href="#">here</a> .
Display string in a formatted manner	#YPF Formatstring, Value1...	Displays a formatted character string. The <b>formatted string</b> specifies the character string. The values are subsequently specified through (multiple) <b>Value(s)</b> . Information on the formatted string can be found <a href="#">here</a> .
Display configuration	#YPI	Displaying the display parameters, such as the width and height, as well as interface settings in the terminal.
Display version string	#YPV	This emits the current version of the display.

## IMAGES/VECTOR GRAPHICS

The module internally uses a special image format (\*.epg). The conversion needs to be done externally. The Windows program EA uniSketch offers the most comfortable option to have most image formats converted. Some [commands](#) make it possible to save the screen content on the SD card or transfer image data directly via the serial interface. Various [image formats](#) are available here.

### Image size

Should the width **Width** OR the height **Height**, be specified by 0, then this size is adjusted proportionally.

Should the width **Width** AND the height **Height**, be specified by 0, the image is then generated in the original size (in pixels).

## ADD IMAGE/VECTOR GRAPHIC.

Parameters that are written in **GREY** in the command tables are considered optional details, and partially have default values. The default values are given in brackets behind the corresponding parameters. Parameters written in **BLACK** on the other hand, must be assigned values. Commands that may contribute towards changing parameters can only be used if the corresponding parameters have already previously been defined. Some commands allow for entering several object IDs. Should these objects be in numerical sequence, the range may be specified with the "-" sign, e.g. 1-5, instead of 1,2,3,4,5.

Designation	Command code	Description
Place image	<b>#PPP</b> Object-id, 'Picturename', PosX, PosY, Anchor(1), Width(0), Height(0), Angle(0)	Defines as an object <b>Object-id</b> , the image file ' <b>Picturename</b> ' and places it independently of the position <b>PosX</b> , <b>PosY</b> , the <a href="#">anchor Anchor</a> (0...9), the image width <b>Width</b> (Pixel), the image height, <b>Height</b> (Pixel) and the angle <b>Angle</b> (0...360). Attention must be paid to whether the image file is named in upper or lower case letters. <a href="#">Beispiel siehe S. 110</a>
Change image animation	<b>#PPA</b> Object-id, AnimationType (0), Time, Image No	Changes, in the object, <b>Object ID</b> , the present animation through the choice of the new <a href="#">animation type AnimationType</a> . The expiration time, <b>Time</b> , (hrs) and the end image, <b>Image No.</b> , are only relevant for the animation type Animation Type = 7. This involves the time in which animation is carried out up to the image number set being defined. The prerequisites for animations are described <a href="#">here</a> <a href="#">Beispiel siehe S. 110</a>
Show video input	<b>#PVP</b> Object-id, PosX, PosY, Anchor(1), Width(0), Height(0), Angle(0)	Defines the image of the video input as Object ID, and places it, depending upon the position PosX, PosY, of the <a href="#">anchor Anchor</a> (0...9), the image width <b>Width</b> (in pixels), the image height <b>Height</b> , (in pixels) and the angle <b>Angle</b> (0...360). <a href="#">Beispiel siehe S. 110</a>

**TYPES OF ANIMATION**

Animations relate to objects of the type of origin **.GIF** or animated gradients.

Designation	Parameter	Description
Stop	0	Defines an animation end.
Cyclical	1	Defines a cyclical animation.
Cyclical, backwards	2	Defines a cyclical animation moving in the opposite direction.
Oscillating	3	Defines an oscillating animation.
Oscillating, backwards	4	Defines an oscillating animation moving in the opposite direction.
One-off	5	Defines a one-off animation.
Once, backwards	6	Defines a one-off animation moving in the opposite direction.
Once, in a fragmented manner	7	Defines an animation section.



## STYLE SHEETS

Allgemeine Informationen zu den Styles befinden sich [hier](#).

Parameters that are written in **GREY** in the command tables are considered optional details, and partially have default values. The default values are given in brackets behind the corresponding parameters. Parameters written in **BLACK** on the other hand, must be assigned values. Commands that may contribute towards changing parameters can only be used if the corresponding parameters have already previously been defined. Some commands allow for entering several object IDs. Should these objects be in numerical sequence, the range may be specified with the "-" sign, e.g. 1-5, instead of 1,2,3,4,5.

## COLOUR GRADIENTS AND LINE PATTERNS

Designation	Command code	Description
Define colour gradient	<b>#CCR</b> Ramp-nr, Offset, RGB, Opacity, reapeate all parameters	Defines a colour gradient <b>Ramp No.</b> (1...255) with the <b>RGB</b> colours (e.g. \$FF0000 for red) and associated transparency <b>Opacity0</b> ...100). The offset <b>Offset</b> (0...100) determines at what point, as a percentage, the next colour is to be found. A maximum of 10 supporting points can be defined in a colour gradient. <a href="#">Beispiel siehe S. 117</a>
Animate colour gradient	<b>#CAC</b> Ramp-nr, AnimationType(1), Time (100)	Animates the colour gradient <b>Ramp No.</b> with the animation type <b>AnimationType</b> (1...7) over the time period <b>Time</b> (hrs). <a href="#">Animation types</a>
Define dash patterns	<b>#CDP</b> Dash-nr, Dashphase, Dash, Space, Dash, Space ...	Defines a dash pattern <b>Dash No.</b> (1...10), depending upon the length of the dash <b>Dash</b> (in pixels) and length of clearance <b>Space</b> (in pixels). The offset <b>Dash Phase</b> (0...100) determines, as a percentage, the starting point from which the dash pattern is drawn. A maximum of 10 combinations for line length and clearance may be defined in a dash pattern. <a href="#">Beispiel siehe S. 117</a>
Animate dash patterns	<b>#CAD</b> Dash-nr, AnimationType(1), Time(100)	Animates the dash pattern <b>Dash No.</b> with the animation type <b>AnimationType</b> (1...7) over the time period <b>Time</b> (hrs).. <a href="#">Animation types</a>

## DRAWING STYLE

Designation	Command code	Description
No filling	<b>#CFD</b> Drawstyle-nr	Defines a <b>Drawing Style</b> Number without a filling. The filling is thus transparent.

Designation	Command code	Description
Define filling colour	#CFC Drawstyle-nr, RGB, Opacity(100)	Defines a drawing style <b>Drawing Style No.</b> with a plain colour filling <b>RGB</b> (e.g. \$FF0000 for red), as well as its transparency <b>Opacity</b> (0...100). <a href="#">Beispiel siehe S. 118</a>
Linear colour gradient	#CFL Drawstyle-nr, Ramp-nr, Angle(0)	Defines a drawing style <b>Drawing Style No.</b> with linear colour gradient <b>Ramp No.</b> and its <b>Angle</b> (0...360). In order to be able to use this command, it is necessary to define a colour gradient in advance. <a href="#">Beispiel siehe S. 118</a>
Radial colour gradient	#CFR Drawstyle-nr, Ramp-nr, FocusX (5000), FocusY(0)	Defines a drawing style <b>Drawing Style No.</b> with a radial colour gradient <b>Ramp No.</b> The focal position <b>FocusX,Y</b> (0...100) defines, as a percentage, the starting point of the gradient. Should the focal point <b>FocusX</b> be specified as being a number of pixels that is greater than 5,000, then <b>FocusY</b> can be set as an anchor. In order to be able to use this command, it is necessary to define a colour gradient in advance. <a href="#">Beispiel siehe S. 118</a>
Conical colour gradient	#CFK Drawstyle-nr, Ramp-nr, FocusX (5000), FocusY(0), Direction	Defines a drawing style <b>Drawing Style No.</b> with a conical colour gradient <b>Ramp No.</b> The focal position <b>FocusX,Y</b> (0...100) defines, as a percentage, the starting point of the gradient. The direction of movement <b>Direction</b> (0= Anti-clockwise; 1= Clockwise) determines the orientation. Should the focal point <b>FocusX</b> be specified as being a number of pixels that is greater than 5,000, then <b>FocusY</b> can be set as an <a href="#">anchor</a> . In order to be able to use this command, it is necessary to define a colour gradient in advance. <a href="#">Beispiel siehe S. 118</a>

Designation	Command code	Description
Filling with a pattern	<b>#CFP</b> Drawstyle-nr, 'Patternname', Size(0), Angle(0), Repeat/Reflekt(0), FocusX (5000), FocusY(0), AnchorP(5)	Defines a <b>Drawing Style No.</b> with a pattern ' <b>Pattern name</b> ' that depends upon the <b>Size</b> (proportional), the <b>Angle</b> (0...360) and the representation <b>Repeat/Reflect</b> (Repeat= 0; Reflect= 1). The focal position <b>FocusX,Y</b> (0...100) defines, as a percentage, the starting point of the gradient. Should the focal point <b>FocusX</b> be specified as being a number of pixels that is greater than 5,000, then <b>FocusY</b> can be set as an <b>anchor Anchor</b> . The pattern anchor <b>AnchorP</b> (0...9) sets the reference point of the pattern. <a href="#">Beispiel siehe S. 119</a>
Change angle of the colour gradient	<b>#CFA</b> Drawstyle-nr, Angle	Changes the colour gradient angle <b>Angle</b> of the drawing style <b>Drawing Style No.</b> .
Change colour gradient	<b>#CFG</b> Drawstyle-nr, Ramp-nr,	Changes the colour gradient <b>Ramp No.</b> of the drawing style <b>Drawing Style No.</b> . In order to be able to use this command, it is necessary to define a colour gradient in advance.
Change focus of the filling	<b>#CFF</b> Drawstyle-nr, FocusX, FocusY, AnchorP(No Change)	Changes the focal position <b>FocusX,Y</b> of the drawing style <b>Drawing Style No.</b> , as well as the patternanchor <b>AnchorP</b> when filled with a pattern.
Change pattern	<b>#CFN</b> Drawstyle-nr, 'Patternname'	Changes the pattern ' <b>Pattern name</b> ' of the drawing style <b>Drawing Style No.</b> . In order to be able to use this command, it is necessary to define a pattern in advance.
Change size of pattern	<b>#CFS</b> Drawstyle-nr, Size	Proportionality changes the size <b>Size</b> of the pattern of the drawing style <b>Drawing Style No.</b> .
Change representation of pattern	<b>#CFT</b> Drawstyle-nr, Repeat/Reflect	Changes the <b>Repeat/Reflect</b> representation of the filling pattern of the drawing style <b>Drawing Style No.</b> .

## LINE STYLE

Designation	Command code	Description
Refrain from defining a line	<b>#CLD</b> Drawstyle-nr	Defines a <b>Drawing Style No.</b> without a line style. The line thus becomes invisible.

Designation	Command code	Description
Define line style	#CLS Drawstyle-nr, RGB, Opacity(100), Width(1), Joint(0), Dash-nr(0)	Defines a drawing style <b>Drawing Style No.</b> with a border, depending upon its <b>RGB</b> colour (e.g. \$FF0000 for red), transparency <b>Opacity</b> (0..100), width <b>Width</b> (in pixels), rounding off <b>Joint</b> (Angular = 0; Round = 1) and dash pattern <b>Dash No.</b> . To use the dash pattern, the latter needs to have been pre-defined. <a href="#">Example</a>
Change line colour	#CLC Drawstyle-nr, RGB, Opacity(No Change)	Changes the <b>RGB</b> colour (e.g. \$FF0000 for red) and transparency <b>Opacity</b> (0..100) of the drawing style <b>Drawing Style No.</b> . In order to be able to use this command, it is necessary to define a colour in advance.
Change line width	#CLW Drawstyle-nr, Width	Changes the <b>Width</b> of the line of the drawing style <b>Drawing Style No.</b> .
Change line end	#CLE Drawstyle-nr, Joint	Changes the line rounding off <b>Joint</b> (Angular = 0; Round = 1) of the line of the drawing style <b>Drawing Style No.</b> . <a href="#">Beispiel siehe S. 119</a>
Change line pattern	#CLP Drawstyle-nr, Dash-nr	Changes the colour gradient <b>Dash No.</b> of the drawing style <b>Drawing Style No.</b> . In order to be able to use this dash pattern, it is necessary to define it in advance

## TEXT STYLE

Designation	Command code	Description
Define text style	#CTF Textstyle-nr, 'Fontname', Size(20 *.evf / 0 *.epf), Align(0), Drawstyle-nr(1), Italic(0), SpaceL(0), SpaceC(0)	Defines a text style <b>Text Style No.</b> with a font ' <b>Font Name</b> ' which depends upon the latter's size <b>Size</b> , orientation <b>Align</b> (0=On the left; 1=Centred; 2=On the right), drawing style <b>Drawing Style No.</b> , italic angle <b>Italic</b> (-45°...45°), line spacing <b>SpaceL</b> (in pixels) and character pitch <b>SpaceC</b> (in pixels). In order to be able to use this command, it is necessary to define a drawing style style in advance. For performance reasons, it is recommended to refrain from using an outline( <a href="#">#CLD</a> ). <a href="#">Beispiel siehe S. 119</a>
Change font	#CTN Textstyle-nr, 'Fontname'	Changes the font ' <b>Font Name</b> ' of the text style <b>Text Style No.</b> .
Change text size	#CTS Textstyle-nr, Size	Changes the size <b>Size</b> of the text style <b>Text Style No.</b> .

Designation	Command code	Description
Change text orientation	#CTA Textstyle-nr, Align	Changes the orientation <b>Align</b> (0=On the left; 1=Centred; 2=On the right) of the text style <b>Text Style No.</b> .
Change text character style	#CTC Textstyle-nr, Drawstyle-nr	Changes the drawing style <b>Drawing Style No.</b> of the text style <b>Text Style No.</b> .
Change text slant	#CTI Textstyle-nr, Italic	Changes the italic angle <b>Italic</b> of the text style <b>Text Style No.</b> .
Change spacing between characters	#CTG Textstyle-nr, Spacel, SpaceC(No Change)	Changes the line spacing <b>Spacel</b> and character pitch <b>SpaceC</b> of the text style <b>Text Style No.</b> . Negative spacing and/or pitch is also possible.

## TOUCH BUTTON STYLE

Designation	Command code	Description
Image for touch button	#CBP Buttonstyle-nr, 'Buttonname'normal, 'Buttonname'down(normal), SizeX(0), SizeY(0)	Defines a button style <b>Button Style No.</b> with an image for the unpressed state ' <b>Button Name'</b> (normal) and pressed state ' <b>Button name'</b> (down), depending upon the image size <b>SizeX</b> , <b>SizeY</b> (in pixels). <a href="#">Beispiel siehe S. 120</a>
Touch button drawing style	#CBD Buttonstyle-nr, 'Drawstyle-nr'normal, 'Drawstyle-nr'down(normal), Width, Height, Radius	Defines a button style <b>Button Style No.</b> with a drawing style for the unpressed state <b>Drawing Style No.(normal)</b> , drawing style for the pressed state <b>Drawing Style No.(down)</b> , button width <b>Width</b> (in pixels), button height <b>Height</b> (in pixels) and corner radius <b>Radius</b> (in pixels). In order to be able to use this command, it is necessary to define a drawing style style in advance. <a href="#">Beispiel siehe S. 120</a>
Text style of touch button	#CBT Buttonstyle-nr, 'Textstyle-nr'normal, 'Textstyle-nr'down, OffsetX, OffsetY	Defines a button style <b>Button Style No.</b> with text style for the unpressed state <b>Text Style No.(normal)</b> , text style for the pressed state <b>Text Style No.(down)</b> and a text offset <b>OffsetX</b> , <b>OffsetY</b> (in pixels)..
Change the proportion of the touch button when pressed	#CBO Buttonstyle-nr, OffsetX(0), OffsetY(OffsetX), Size(0), Angle(0)	Defines a button style <b>Button Style No.</b> for the pressed state with an offset <b>OffsetX</b> , <b>OffsetY</b> (in pixels), change in size <b>Size</b> (proportional) and change in the angle <b>Angle</b> (0...360). <a href="#">Beispiel siehe S. 120</a>

Designation	Command code	Description
Touch button disabled	<b>#CBG</b> Buttonstyle-nr, DisableR(-30), DisableG(DisableR), DisableB(DisableR)	Defines a deactivated/greyed out button style <b>Button Style No.</b> , depending upon a subtraction of the colour portions red <b>DisableR</b> (-100...0), green <b>DisableG</b> (-100...0)and blue <b>DisableB</b> (-100...0).
Sound relating to touch button	<b>#CBS</b> Buttonstyle-nr, 'Soundname'(alten löschen)	Defines a sound in the button style <b>Button Style No.</b> with the audio file " <b>Sound Name</b> ". Should no audio file be specified, then the old sound will be deleted. Should a 0 be specified for button style, then the standard sound is selected.

## DRAWING/GRAPHIC PRIMITIVES

Parameters that are written in **GREY** in the command tables are considered optional details, and partially have default values. The default values are given in brackets behind the corresponding parameters. Parameters written in **BLACK** on the other hand, must be assigned values. Commands that may contribute towards changing parameters can only be used if the corresponding parameters have already previously been defined. Some commands allow for entering several object IDs. Should these objects be in numerical sequence, the range may be specified with the "-" sign, e.g. 1-5, instead of 1,2,3,4,5.

Designation	Command code	Description
Rectangle	<b>#GRR</b> Object-id, Drawstyle-nr, PosX, PosY, Anchor, Width, Height(same as Width), Radius(0), BorderWidth(0), Angle(0)	Defines as an object <b>Object ID</b> a rectangle, depending upon the drawing style <b>Drawing Style No.</b> , the position <b>PosX</b> , <b>PosY</b> , the anchor <b>Anchor</b> , (0...9), the width <b>Width</b> (in pixels), the height <b>Height</b> (in pixels), the radius for the corners <b>Radius</b> (in pixels), the border width <b>BorderWidth</b> , (0...100) and the angle <b>Angle</b> (0...360). In order to be able to use this command, it is necessary to define a drawing style style in advance. <a href="#">Example</a>
Draw polyline	<b>#GPL</b> Object-id, Drawstyle-nr, PosX, PosY, PosX2, PosY2, PosX3, PosY3, ...	Defines as an object, <b>Object ID</b> a polyline, depending upon the drawing style, <b>Drawing Style No.</b> and the corresponding position points <b>PosX</b> , <b>PosY</b> . To use the command, a drawing style needs to have been defined in advance. <a href="#">Beispiel siehe S. 124</a>
Polygon(filled in)	<b>#GPF</b> Object-id, Drawstyle-nr, PosX, PosY, PosX2, PosY2, PosX3, PosY3, ..., autoclose polygon	Defines as an object, <b>Object ID</b> a filled-in polygon, depending upon the drawing style, <b>Drawing Style No.</b> and the position points <b>PosX</b> , <b>PosY</b> . To use the command, a drawing style needs to have been defined in advance. The polygon is automatically concluded after the last position value. <a href="#">Beispiel siehe S. 124</a>
Extend a polyline/polygon	<b>#GPA</b> Object-id, PosX, PosY, PosX2, PosY2, ...	Adds additional positions <b>PosX</b> , <b>PosY</b> to the object, <b>Object ID</b> , of <b>#GPF</b> and <b>#GPL</b> . <a href="#">Beispiel siehe S. 124</a>
Polypath segment	<b>#GPP</b> Object-id, Drawstyle-nr, PosX, PosY, Segment1, Segment2, ...	Defines as an object, <b>Object ID</b> a filled-in polygon, depending upon the drawing style, <b>Drawing Style No.</b> , the position points, <b>PosX</b> , <b>PosY</b> and the individual <a href="#">segments Segment</a> . These also allow for having round shapes. To use the command, a drawing style needs to have been defined in advance. <a href="#">Beispiel siehe S. 125</a>

Designation	Command code	Description
Polygon(geometric)	<b>#GPP</b> Object-id, Drawstyle-nr, PosX, PosY, Anchor, Radius, NumberCorners, BorderWidth(0), Angle(0)	Defines as an object <b>Object ID</b> a polygon, depending upon the drawing style <b>Drawing Style No.</b> , the position points, <b>PosX</b> , <b>PosY</b> , the <a href="#">anchor</a> , <b>Anchor(0...9)</b> , of the radius <b>Radius</b> (in pixels), the number of corners <b>NumberCorners</b> , the border width <b>Border Width</b> (0...100) and the angle <b>Angle</b> (0...360). To use the command, a drawing style needs to have been defined in advance. <a href="#">Beispiel siehe S. 125</a>
Polygon(star)	<b>#GGS</b> Object-id, Drawstyle-nr, PosX, PosY, Anchor, Radius1, Radius2, CountPoints, BorderWidth(0), Angle(0)	Defines as an object <b>Object ID</b> a star-shaped polygon, depending upon the drawing style <b>Drawing Style No.</b> , the position points <b>PosX</b> , <b>PosY</b> , the <a href="#">anchor</a> <b>Anchor</b> (0...9), the external radius <b>Radius1</b> (in pixels), the internal radius <b>Radius2</b> (in pixels), the number of points <b>CountPoints</b> , the border width <b>Border Width</b> (0...100) and the angle <b>Angle</b> (0...360). To use the command, a drawing style needs to have been defined in advance. <a href="#">Beispiel siehe S. 125</a>
Circle/ellipse	<b>#GET</b> Object-id, Drawstyle-nr, PosX, PosY, Anchor, Radius1, Radius2(Radius1), BorderWidth(0), Angle(0)	Defines as an object <b>Object ID</b> a circular or elliptical polygon, depending upon the drawing style <b>Drawing Style No.</b> , the position points, <b>PosX</b> , <b>PosY</b> , the anchor <b>Anchor</b> (0...9), the external radius <b>Radius1</b> (in pixels), the internal radius <b>Radius2</b> , the border width <b>Border Width</b> (0...100) and the angle <b>Angle</b> (0...360). To use the command, a drawing style needs to have been defined in advance. <a href="#">Beispiel siehe S. 126</a>
Arc of a circle	<b>#GEA</b> Object-id, Drawstyle-nr, PosX, PosY, Anchor, Radius1, Radius2(Radius1), StartAngle(0), StopAngle(360), BorderWidth(0), Angle(0)	Defines as an object <b>Object ID</b> a curved polygon, depending upon the drawing style <b>Drawing Style No.</b> , the position points, <b>PosX</b> , <b>PosY</b> , the anchor <b>Anchor</b> (0...9), the external radius <b>Radius1</b> (in pixel)s, the internal radius <b>Radius2</b> , the starting angle <b>Starting Angle</b> (0...360), the stop angle <b>Stop Angle</b> (0...360), the border width <b>Border Width</b> (0...100) and the angle <b>Angle</b> (0...360). To use the command, a drawing style needs to have been defined in advance. <a href="#">Beispiel siehe S. 126</a>



Designation	Command code	Description
Straight cut	<b>#GES</b> Object-id, Drawstyle-nr, PosX, PosY, Acnhor, Radius 1, Radius2(Radius1), StartAngle(0), StopAngle(360), Angle (0)	Defines as an object <b>Object ID</b> a cut circle, depending upon the drawing style <b>Drawing Style No.</b> , the position points, <b>PosX</b> , <b>PosY</b> , the <a href="#">anchor Anchor</a> (0...9), the length radius <b>Radius1</b> (in pixels), the height radius <b>Radius2</b> , the starting angle <b>Starting Angle</b> (0...360), the stop angle <b>Stop Angle</b> (0...360), the border width <b>Border Width</b> (0...100) and the angle <b>Angle</b> (0...360). To use the command, a drawing style needs to have been defined in advance. <a href="#">Beispiel siehe S. 126</a>
Section	<b>#GEP</b> Object-id, Drawstyle-nr, PosX, PosY, Anchor, Radius1, Radius2(Radius1), StartAngle(0), StopAngle(360), Angle (0)	Defines as an object <b>Object ID</b> a section of a polygon, depending upon the drawing style <b>Drawing Style No.</b> , the position points, <b>PosX</b> , <b>PosY</b> , the <a href="#">anchor Anchor</a> (0...9), the external radius <b>Radius1</b> (in pixels), the internal radius <b>Radius2</b> , the starting angle <b>Starting Angle</b> (0...360), the stop angle <b>Stop Angle</b> (0...360), the border width <b>Border Width</b> (0...100) and the angle <b>Angle</b> (0...360). To use the command, a drawing style needs to have been defined in advance. <a href="#">Beispiel siehe S. 126</a>

## SEGMENT TYPES

General information on the segments can be found [here](#).

Designation	Parameter	Description
Horizontal line	?H, x	Defines the position <b>x</b> for a horizontal line point. <a href="#">Beispiel siehe S. 127</a>
Vertical line	?V, y	Defines the position <b>y</b> for a vertical line point. <a href="#">Beispiel siehe S. 127</a>
Freehand line	?L, x, y	Defines the position <b>x, y</b> for the next line point. <a href="#">Beispiel siehe S. 127</a>
Arc of a circle	?Ct, r, x, y	Defines the position <b>x, y</b> for the next point of the arc, as well as its radius <b>r</b> (in pixels). <a href="#">Beispiel siehe S. 128</a>
Elliptical arc	?Et, rx, ry, Angle, x, y	Defines the position <b>x, y</b> for the next point of the ellipse, as well as its radius <b>rx, ry</b> (in pixels) and <b>Angle</b> . <a href="#">Beispiel siehe S. 128</a>
Quadratic Bézier curve	?Q, c1x, c1y, x, y	Defines the positions <b>c1x, c1y</b> , as well as <b>x, y</b> and for the quadratic Bézier curve. <a href="#">Beispiel siehe S. 128</a>
Slight quadratic Bézier curve	?R, x, y	Defines the position <b>x, y</b> for an addition to the quadratic Bézier curve. Mirrors <b>c1x</b> and <b>c1y</b> of the previous segment, i.e. this command is not suitable for only one segment. <a href="#">Beispiel siehe S. 128</a>
Cubic Bézier curve	?S, c1x, c1y, c2x, c2y, x, y	Defines the positions <b>c1x, c1y</b> and <b>c2x, c2y</b> , as well as <b>x, y</b> , for the cubic Bézier curve. <a href="#">Beispiel siehe S. 129</a>
Slight cubic Bézier curve	?T, c2x, c2y, x, y	Defines the positions <b>c2x, c2y</b> and <b>x, y</b> for an addition to the cubic Bézier curve. Mirrors <b>c1x</b> and <b>c1y</b> of the previous segment, i.e. this command is not suitable for a single segment. <a href="#">Beispiel siehe S. 129</a>
Close path	?Z	Defines the path end, i.e. the next point is the starting point of the first segment. <a href="#">Beispiel siehe S. 129</a>
Jump (new sub-path)	?M x, y	Defines a new starting point for the subsequent segment. <a href="#">Beispiel siehe S. 129</a>

## STRINGS AND CHARACTER STRING COMMANDS

Parameters that are written in **GREY** in the command tables are considered optional details, and partially have default values. The default values are given in brackets behind the corresponding parameters. Parameters written in **BLACK** on the other hand, must be assigned values. Commands that may contribute towards changing parameters can only be used if the corresponding parameters have already previously been defined. Some commands allow for entering several object IDs. Should these objects be in numerical sequence, the range may be specified with the “-” sign, e.g. 1-5, instead of 1,2,3,4,5.

Designation	Command code	Description
Place character string	<b>#SSP</b> Object-id, Textstyle-nr, PosX, PosY, Anchor, 'String'	Defines as an object <b>Object ID</b> a ' <b>String</b> ' and places it, depending upon the text style <b>Text Style No.</b> , the position <b>PosX</b> , <b>PosY</b> and the <b>anchor Anchor</b> . <a href="#">Beispiel siehe S. 115</a>
Change character string	<b>#SSC</b> Object-id, String	Changes the string allocated in the object <b>Object ID</b> into a new string ' <b>String</b> '.
Place formatted character string	<b>#SFP</b> Object-id, Textstyle-nr, PosX, PosY, Anchor, 'Formatstring'; Value1...	Defines as an object <b>Object ID</b> a ' <b>Format String</b> ' and places it, depending upon the text style <b>Text Style No.</b> , the position <b>PosX</b> , <b>PosY</b> and the anchor <b>Anchor</b> . The content of the string is, among other things, determined by the successive values <b>Value</b> . <a href="#">Beispiel siehe S. 115</a>
Change formatted character string	<b>#SFC</b> Object-id, Value1...	Changes the value <b>Value</b> of the formatted string of the object <b>Object ID</b> .
Place calculation string (auto update)	<b>#SAP</b> Object-id, Textstyle-nr, PosX, PosY, Anchor, 'Formatstring'; Value1(Calculation), Value2	Defines as an object <b>Object ID</b> a 'Format String' and places it, depending upon the text style <b>Text Style No.</b> , the position <b>PosX</b> , <b>PosY</b> and the <b>anchor Anchor</b> . The content of the string is, among other things, determined by the successive calculated values <b>Value</b> . In the event of the calculation of the first value being amended <b>Value1</b> , the display is renewed. <a href="#">Beispiel siehe S. 115</a>
Change auto update of the calculation string.	<b>#SAC</b> Object-id, (ChangeCalculation)	Updates the update calculation <b>ChangeCalculation</b> for the automatic display in the object <b>Object ID</b> . The calculation of the values of the calculation string is, in that respect, not changed. The changed calculation always has the Integer data type. <a href="#">Beispiel siehe S. 115</a>

Designation	Command code	Description
Place date/time string	<b>#SDP</b> Object-id, Textstyle-nr, PosX, PosY, Anchor, DateFormat (Date), Date32 (actual time)	Defines as an object <b>Object ID</b> a string and places it, depending upon the text style <b>Text Style No.</b> , the position <b>PosX</b> , <b>PosY</b> and the anchor <b>Anchor</b> . The content of the string is determined by the choice of date format <b>DateFormat</b> (#WDF), the current time and the current date <b>Date32</b> . The time is updated automatically. The last optional parameter <b>Date32</b> can be specified unless the current time is supposed to be displayed.
Change date/time string	<b>#SDC</b> Object-id, Date32(actual time)	Changes the time or date specification <b>Date32</b> of the time string <b>Object ID</b> .

## EDIT BOX

The edit box is an editable box for strings. The latter is used, for example, in combination with the keyboard. The default string is the first visible display of the edit box, and exists once the corresponding function is accessed.

Designation	Command code	Description
Place edit box for strings	<b>#SEP</b> Object-id, Drawstyle-nr, PosX, PoxY, Anchor Width, Height, Radius, Textstyle, OffsetX, OffsetY	Defines as an object <b>Object ID</b> an editable string box, and places it, depending upon the drawing style <b>Text Style No.</b> , the position <b>PosX</b> , <b>PosY</b> and the anchor <b>Anchor</b> . The width <b>Width</b> , height <b>Height</b> , rounding of the corners <b>Radius</b> , text style <b>Text Style</b> distance from the lateral edge <b>OffsetX</b> and offset in the Y direction <b>OffsetY</b> likewise need to be specified for the creation. <a href="#">Beispiel siehe S. 115</a>
Send default string to edit box	<b>#SED</b> Object-id, Strings...	Defines, as an object <b>Object ID</b> , a default string <b>String</b> , and transmits it to the edit box.
Send code/string to edit box	<b>#SEC</b> Object-id, Codes/Strings...	Defines, as an object <b>Object ID</b> , codes or strings <b>String</b> , and transmits them to the edit box.
Link keyboard to edit box	<b>#SEK</b> Keyboard-id, Object-id...	Links a keyboard <b>Keyboard ID</b> with one or more edit boxes <b>Object ID</b> . As a result, it is possible to edit multiple edit boxes with one keyboard <a href="#">Beispiel siehe S. 115</a>

Designation	Command code	Description
Enable edit box for keyboard	#SEA Object-id	Activates an edit box <b>Object ID</b> for the linked keyboard. That means that one of the edit boxes allocated to the keyboard can be activated for processing. Always only one edit box is active. <b>Object ID= 0</b> disables all edit boxes. <a href="#">Beispiel siehe S. 115</a>

## TOUCH OBJECTS / TOUCH FUNCTIOS

Two types of operation are available for touch areas:

Touch button (**B**) = Pushing, they jump into the non-pressed state as soon as the actuation is finished.

Touch switch(**S**) = Switching on, the state is changed once

Parameters that are written in **GREY** in the command tables are considered optional details, and partially have default values. The default values are given in brackets behind the corresponding parameters. Parameters written in **BLACK** on the other hand, must be assigned values. Commands that may contribute towards changing parameters can only be used if the corresponding parameters have already previously been defined. Some commands allow for entering several object IDs. Should these objects be in numerical sequence, the range may be specified with the “-” sign, e.g. 1-5, instead of 1,2,3,4,5.

## DEFINITION OF TOUCH OBJECTS

Designition	Command code	Description
Rectangular touch button	<b>#TBR</b> Object-id, Buttonstyle-nr, 'Text'(normal), 'Text'(down), PosX, PosY, Anchor(5), Width(Buttonstyle), Height (Buttonstyle) <b>#TSR</b>	The touchbutton <b>Object-id</b> with button style <b>Buttonstyle-nr</b> , both strings for pressed <b>'Text'</b> (normal) and unpressed <b>Text</b> (down) state is drawn. The width <b>Width</b> (Pixel) and height <b>Height</b> (Pixel) out of the button style is used, but you can set it individually, too. You have to define a <a href="#">button style</a> before using this command. <a href="#">Beispiel siehe S. 122</a>
Elliptical touch button	<b>#TBE</b> Object-id, Buttonstyle-nr, 'Text'(normal), 'Text'(down), PosX, PosY, Anchor (5), Width(Buttonstyle), Height (Buttonstyle) <b>#TSE</b>	The elliptical touch button <b>Object-id</b> with button style <b>Buttonstyle-nr</b> , both strings for pressed <b>'Text'</b> (normal) and unpressed <b>Text</b> (down) state is drawn. The width <b>Width</b> (Pixel) and height <b>Height</b> (Pixel) out of the button style is used, but you can set it individually, too. You have to define a <a href="#">button style</a> before using this command. <a href="#">Beispiel siehe S. 122</a>
Touch button as an image	<b>#TBP</b> Object-id, Buttonstyle-nr, 'Text'(normal), 'Text'(down), PosX, PosY, Anchor (5), SizeX(Buttonstyle), SizeY (Butonstyle) <b>#TSP</b>	An image is used touch object <b>Object-id</b> . Properties are set in the button style <b>Buttonstyle-nr</b> . The string for unpressed <b>'Text'</b> (normal) and pressed <b>Text</b> (down) , the position <b>PosX</b> , <b>PosX</b> need to be handed over. The <a href="#">anchor</a> <b>Anchor</b> , width <b>SizeX</b> (Pixel) and height <b>SizeY</b> (Pixel) can be set up through the button style.können auch aus dem Buttonstyle übernommen werden. ZYou have to define a <a href="#">button style</a> before using this command ( <a href="#">#CBP</a> ). <a href="#">Beispiel siehe S. 122</a>

Designation	Command code	Description
Convert Object to a touch switch / button	<b>#TBO</b> Object-id, Buttonstyle-nr, 'Text'(normal), 'Text'(down) <b>#TSO</b>	converts any object into a touchable object element <b>Object-id</b> . All the additional information required for creating a touch area is taken from the button style <b>Buttonstyle-nr</b> . The text for the unpressed <b>'Text'(normal)</b> and pressed state <b>Text(down)</b> are handed over, too. You have to define a <a href="#">button style</a> before using this command.

## TOUCH FUNCTIONS

Designation	Command code	Description
Change touch status	<b>#TCS</b> Touchstate, Object-id ...	Changes the state <b>Touchstate</b> (0= pressed; 1= unpressed; 2= deactivated) of one ore more touch objects <b>Object-id</b>
Change touch labeling	<b>#TCL</b> Object-id, 'Text'(normal), 'Text'(down)	Changes the text <b>Text(normal/down)</b> of a touch object <b>Object-id</b> .
Disable/Enable Touch	<b>#TCE</b> State, Object-id ...	Activates ( <b>State = 1</b> ) or deactivates <b>State = 0</b> ) one or more touch objects <b>Object-id</b> .
Touch responses	<b>#TCR</b> Signal, Filter, Object-id ...	Determination of the behavior of one or more touch subjects <b>Object-id</b> . <b>Signal</b> parameter is used to define which actions can be called 1= unpressed; 2= pressed; 3= pressed and unpressed; 4 = drag; 7 = evrything The filter <b>Filter</b> offers the possibility to block the transmission depending on the macro definition: 0= only send if there is no macro defined; 1 =send always
Assign a touch response to the object	<b>#TID</b> Mask, Object-id ...	Assignes one or more objects <b>Object-id</b> a touch action <b>Mask</b> (1= internally; 2= move; 4= resize, 8= rotate). <b>Mask=1</b> is used for special touch objects, like bargraphs or indicational instruments. <b>Mask= 2</b> the object is movable on the screen for the user, <b>Mask= 4</b> resizing object, <b>Mask= 8</b> rotates the objects around its' anchor
Check status touch switch	<b>#TQS</b> Object-id ...	Sends the status of the object <b>Object-id</b> . A more precise description of the system response can be found in the chapter <a href="#">Responsens. (#HAR)(#TQS)</a>
Create radio-group	<b>#TRA</b> Group-id, Object-id...	Creates a new object <b>Group-id</b> and includes some touchbuttons <b>Object-id</b> , to create a radio group.

Designation	Command code	Description
Check the active switch of the radio group	<b>#TQR</b> Group-id ...	Sends the status of one or more radio groups <b>Group-id</b> . A more precise description of the system response can be found in the chapter <a href="#">Responsens. (#HAR)</a> ( <a href="#">#TQR</a> )



## BAR GRAPHS AND INSTRUMENTS

Parameters that are written in **GREY** in the command tables are considered optional details, and partially have default values. The default values are given in brackets behind the corresponding parameters. Parameters written in **BLACK** on the other hand, must be assigned values. Commands that may contribute towards changing parameters can only be used if the corresponding parameters have already previously been defined. Some commands allow for entering several object IDs. Should these objects be in numerical sequence, the range may be specified with the “-” sign, e.g. 1-5, instead of 1,2,3,4,5.

Designation	Command code	Description
Bar graph -rectangle	<b>#IBR</b> Object-id, Drawstyle-Front, Drawstyle-Back, PosX, PosY, Anchor, Width, Height, Radius(0), Startvalue(0), Endvalue(100), Course(1), Angle(0)	Defines a rectangular bar graph as an object <b>Object ID</b> , depending upon the drawing style of the foreground <b>Drawing Style No. Front</b> , the drawing style of the <b>background Drawing Style Back</b> , the position <b>PosX, PosY</b> , the <a href="#">anchor Anchor(0...9)</a> , the width <b>Width(Pixel)</b> of the bar, the bar's height <b>Height(Pixel)</b> , the radius <b>Radius</b> for the corners, the <b>Start Value</b> , the <b>End Value</b> , the direction <b>Course(0=right→ left; 1=left→ right)</b> and the angle <b>Angle(0...360)</b> . <a href="#">Beispiel siehe S. 112</a>
Bar graph - triangle	<b>#IBT</b> Object-id, Drawstyle-Front, Drawstyle-Back, PosX, PosY, Anchor, Width, Height, Tip(0), Startvalue(0), Endvalue(100), Course(1), Angle(0)	Defines a triangular bar graph as an object <b>Object ID</b> , depending upon the drawing style of the foreground <b>Drawstyle Front</b> , the drawing style of the background <b>Drawstyle Back</b> , the position <b>PosX, PosY</b> , the anchor <b>Anchor(0...9)</b> , the width of the bar graphs <b>Width(in pixels)</b> , the height of the bar graphs <b>Height(in pixels)</b> , the position of the tip <b>Tip(0=Bot; 1=Top; 2=Mid)</b> , of the start value <b>Start Value</b> , the end value <b>End Value</b> , the direction of movement <b>Course(0=Large→small; 1=Small→large)</b> and the angle <b>Angle(0...360)</b> . <a href="#">Beispiel siehe S. 112</a>

Designation	Command code	Description
Bar graph - arc	<b>#IBA</b> Object-id, Drawstyle-Front, Drawstyle-Back, PosX, PosY, Anchor, Radius, Borderwidth, Startangle, Stopangle, Startvalue(0), Endvalue(100), Direction(1)	Defines a curved bar graph as an object <b>Object ID</b> , depending upon the drawing style of the foreground <b>Drawstyle Front</b> , the drawing style of the background <b>Drawstyle Back</b> , the position <b>PosX</b> , <b>PosY</b> , the anchor <b>Anchor(0...9)</b> , the radius to the curvature of the bar graph <b>Radius</b> , the height of the bar graph as a <b>border width</b> of the defined circle <b>Border Width</b> (in pixels), the starting angle <b>Start Angle(0...360)</b> , the end angle <b>Stop Angle(0...360)</b> , the starting value <b>Start Value</b> , the end value <b>End Value</b> and the direction of movement <b>Direction(0=Anti-clockwise; 1=Clockwise)</b> <a href="#">Beispiel siehe S. 112</a>
Place instrument picture	<b>#IPP</b> Object-id, "Instrumentname", PosX, PosY, Anchor, Width(0), Height(0), Startvalue(0), Endvalue(100), Angle(0)	Defines as an object <b>Object ID</b> a rectangle, depending upon the drawing style, <b>Drawing Style No.</b> , the position <b>PosX</b> , <b>PosY</b> , the <a href="#">anchor Anchor(0...9)</a> , the width, <b>Width</b> (in pixels), the height, <b>Height</b> (in pixels), the radius for the corners, <b>Radius</b> (in pixels), the border width, <b>Border Width</b> , (0...100) and the angle, <b>Angle</b> (0...360). <a href="#">Beispiel siehe S. 113</a>
Define rotational instrument	<b>#IGM</b> Group-id, Indicator-id, Startangle, DeltaAngle, Startvalue(0), Endvalue(100)	Defines an object group <b>Group-ID</b> as a rotational instrument. For use, the rotating object <b>Indicator ID</b> , starting angle <b>Start Angle</b> and angle of rotation <b>Delta Angle</b> need to be established. Starting value <b>Start Value</b> and end value <b>End Value</b> determine the range of values. <a href="#">Beispiel siehe S. 112</a>
Define slider	<b>#IGS</b> Group-id, Path-id, Slide-id, Turn(0), Startvalue(0), Endvalue(100)	Defines an object group <b>Group-ID</b> as a slider. For use, the path of the slider <b>Path ID</b> and sliding object <b>Slide ID</b> need to be established. Torsion in the case of the revolution of the path <b>Turn</b> is an optional detail. Starting value <b>Start Value</b> and end value <b>End Value</b> determine the range of value <a href="#">Beispiel siehe S. 113</a>

Designation	Command code	Description
Set value	<b>#IVS</b> Object-id, Current, Time(0), ActionCurve(0)	Setzt das Instrument <b>Object-id</b> auf einen Wert <b>Current</b> . Die Animation der Werteinstellung wird durch die Dauer <b>Time</b> (hs) und die Aktionskurve <b>ActionCurve</b> (1... 10) bestimmt.
Automatically change value	<b>#IVA</b> Object-id, BarCalculation, Time(0), ActionCurve(0)	Sets the instrument <b>Object ID</b> to a value <b>BarCalculation</b> . The animation of the value setting is determined by the duration <b>Time</b> (hrs) and the action curve <b>Action Curve</b> (1...10). <a href="#">Beispiel siehe S. 113</a>
Update calculation	<b>#IVC</b> Object-id, ChangeCalculation(bar calculation)	Initiates in the instrument or bar graphs <b>Object ID</b> a recalculation <b>Change Calculation</b> . The calculation is always of the "Integer" data type.

## OBJECTS

Allgemeine Informationen zu den Objekten befinden sich [hier](#).

Parameters that are written in **GREY** in the command tables are considered optional details, and partially have default values. The default values are given in brackets behind the corresponding parameters. Parameters written in **BLACK** on the other hand, must be assigned values. Commands that may contribute towards changing parameters can only be used if the corresponding parameters have already previously been defined. Some commands allow for entering several object IDs. Should these objects be in numerical sequence, the range may be specified with the "-" sign, e.g. 1-5, instead of 1,2,3,4,5.

## DEFINITION OF OBJECTS

Designation	Command code	Description
Objects visible	<b>#OVV</b> Object-id, Object-id...	Visibility of objects <b>Object-id</b> . The <b>Object-id</b> = 0, means that the command is used for all defined objects You can also input a range :("ID1 - ID10"). The order of processing depends on the specification of the two object IDs.
Object invisible	<b>#OVI</b> Object-id, Object-id...	Invisibility of objects <b>Object-id</b> . The <b>Object-id</b> = 0, means that the command is used for all defined objects You can also input a range :("ID1 - ID10"). The order of processing depends on the specification of the two object IDs.
Set free anchor (0)	<b>#OAS</b> Anchor0X, Anchor0Y, Object-id, Object-id...	The free <a href="#">anchor</a> <b>Anchor</b> = 0 of one ore more objects <b>Object-id</b> is set through the position <b>Anchor0X</b> , <b>Anchor0Y</b> .
Set free anchor (0) relatively	<b>#OAO</b> Anchor0X, Anchor0Y, Object-id, Object-id...	The free <a href="#">anchor</a> <b>Anchor</b> = 0 of one or more objects <b>Object-id</b> is set through the position <b>Anchor0X</b> , <b>Anchor0Y</b> relatively to the objects. You can also input a range :("ID1 - ID10"). The order of processing depends on the specification of the two object IDs.
Set active anchor	<b>#OAA</b> Anchor, Object-id, Object-id...	Sets the <a href="#">anchor</a> <b>Anchor</b> (0-9) of the objects. You can also input a range :("ID1 - ID10"). The order of processing depends on the specification of the two object IDs.
Group objects	<b>#OGA</b> Group-id, Object-id, Object-id...	Defines a group <b>Group-id</b> , consisting of different <b>Object-id</b> . You can also input a range :("ID1 - ID10"). The order of processing depends on the specification of the two object IDs. Informationen zu Gruppen befinden sich <a href="#">hier</a> .

Designation	Command code	Description
Draw object frame	<b>#OFP</b> Drawstyle-nr, addL/R, addT/B, Object-id, Object-id...	Draws a frame around the object <b>Object-id</b> depending on the style <b>Drawstyle-nr</b> and additional dots around the object left/right <b>addL/R</b> and top/bottom <b>addT/B</b> . The <b>Object-id = 0</b> , means that the command is used for all defined objects You can also input a range : ("ID1 - ID10"). The order of processing depends on the specification of the two object IDs.
Objekt delete	<b>#ODI</b> Object-id, Object-id...	Deletes one or more objects <b>Object-id</b> . Styles won't be deleted as they aren't objects..The <b>Object-id = 0</b> , means that the command is used for all defined objects You can also input a range : ("ID1 - ID10"). The order of processing depends on the specification of the two object IDs.

## CHANGE OF OBJECTS

Designation	Command code	Description
Change position absolut	<b>#OPA</b> PosX, PosY, Object-id, Object-id...	Change position <b>PosX</b> , <b>PosY</b> of one ore more objects <b>Object-id</b> . The <b>Object-id = 0</b> , means that the command is used for all defined objects You can also input a range : ("ID1 - ID10"). The order of processing depends on the specification of the two object IDs.
Change position relativ	<b>#OPR</b> PosX, PosY, Object-id, Object-id...	Change relatively the position <b>PosX</b> , <b>PosY</b> of one ore more objects <b>Object-id</b> . The <b>Object-id = 0</b> , means that the command is used for all defined objects You can also input a range : ("ID1 - ID10"). The order of processing depends on the specification of the two object IDs.
Change size absolut	<b>#OSA</b> Width, Height, Object-id, Object-id...	Changes width <b>Width</b> and height <b>Height</b> of one ore more objects <b>Object-id</b> . The <b>Object-id = 0</b> , means that the command is used for all defined objects You can also input a range : ("ID1 - ID10"). The order of processing depends on the specification of the two object IDs.

Designation	Command code	Description
Change size relativ	<b>#OSR</b> Width, Height, Object-id, Object-id...	Changes width <b>Width</b> and height <b>Height</b> with addition or subtraction of one or more objects <b>Object-id</b> . The <b>Object-id = 0</b> , means that the command is used for all defined objects You can also input a range : ("ID1 - ID10"). The order of processing depends on the specification of the two object IDs.
Change shear absolut	<b>#OHA</b> ShearX, ShearY, Object-id, Object-id...	Changes shearing <b>ShearX, ShearY</b> (degrees) of one or more objects <b>Object-id</b> . The <b>Object-id = 0</b> , means that the command is used for all defined objects You can also input a range : ("ID1 - ID10"). The order of processing depends on the specification of the two object IDs.
Change shear relativ	<b>#OHR</b> ShearX, ShearY, Object-id, Object-id...	Changes shearing relativ <b>ShearX, ShearY</b> (degrees) of one or more objects <b>Object-id</b> . The <b>Object-id = 0</b> , means that the command is used for all defined objects You can also input a range : ("ID1 - ID10"). The order of processing depends on the specification of the two object IDs.
Change rotation absolut	<b>#ORA</b> Angle, Object-id, Object-id...	Changes the angle <b>Angle</b> of one or more objects <b>Object-id</b> . The <b>Object-id = 0</b> , means that the command is used for all defined objects You can also input a range : ("ID1 - ID10"). The order of processing depends on the specification of the two object IDs.
Change rotation relative	<b>#ORR</b> Angle, Object-id, Object-id...	Changes the angle relatively <b>Angle</b> of one or more objects <b>Object-id</b> . The <b>Object-id = 0</b> , means that the command is used for all defined objects You can also input a range : ("ID1 - ID10"). The order of processing depends on the specification of the two object IDs.
Change transparency absolut	<b>#OOA</b> Opacity, Object-id, Object-id...	Changes the transparency <b>Opacity</b> of one or more objects <b>Object-id</b> . The <b>Object-id = 0</b> , means that the command is used for all defined objects You can also input a range : ("ID1 - ID10"). The order of processing depends on the specification of the two object IDs.

Designation	Command code	Description
Change transparency relative	<b>#OOR</b> Opacity, Object-id, Object-id...	Changes the transparency relatively <b>Opacity</b> of one ore more objects <b>Object-id</b> . The <b>Object-id = 0</b> , means that the command is used for all defined objects You can also input a range :("ID1 - ID10"). The order of processing depends on the specification of the two object IDs.
Change Draw-/Text-/Buttonstyle	<b>#OCS</b> Style-nr, Object-id, Object-id...	Changes the used style <b>Style-nr</b> (Drawstyle-nr, Textstyle-nr oder Buttonstyle-nr) of one ore more objects <b>Object-id</b> . The <b>Object-id = 0</b> , means that the command is used for all defined objects You can also input a range :("ID1 - ID10"). The order of processing depends on the specification of the two object IDs.
Change color	<b>#OCC</b> AddR, AddG, AddB, Object-id, Object-id...	Change color <b>RGB</b> (e.g: \$FF0000 red) of one ore more objects <b>Object-id</b> through adding color parts <b>AddR</b> (-100...100), green <b>AddG</b> (-100...100) and blue <b>AddB</b> (-100...100). The <b>Object-id = 0</b> , means that the command is used for all defined objects You can also input a range :("ID1 - ID10"). The order of processing depends on the specification of the two object IDs.
Change layer absolut	<b>#OLA</b> Nr, Object-id, Object-id...	Changes the object layer <b>Nr</b> of one ore more objects <b>Object-id</b> . The specified objects are assigned one after the other to the selected object plane, i.e. the last object is located on the desired object level and the other objects under it. If there is no "space" below the selected object level, the other objects are placed over it. Level 1 is the lowest level. You can also input a range : ("ID1 - ID10"). The order of processing depends on the specification of the two object IDs. Example: <b>#OLA 1, 1, 2, 3</b> Object 3 is on layer 1. Object 2 on layer 2 and object 1 on layer 3.
Change layer absolut	<b>#OLR</b> Difference, Object-id, Object-id...	Changes the layer raltive to ech object <b>Object-id</b> . Positive numbers set the object to a higher, negative numbersto a lower layer. You can also input a range :("ID1 - ID10"). The order of processing depends on the specification of the two object IDs.

## VARIABLES AND REGISTERS

Parameters that are written in **GREY** in the command tables are considered optional details, and partially have default values. The default values are given in brackets behind the corresponding parameters. Parameters written in **BLACK** on the other hand, must be assigned values. Commands that may contribute towards changing parameters can only be used if the corresponding parameters have already previously been defined. Some commands allow for entering several object IDs. Should these objects be in numerical sequence, the range may be specified with the "-" sign, e.g. 1-5, instead of 1,2,3,4,5.

Designation	Command code	Description
Load string file	<b>#VFL</b> 'Stringfilename'	Loads the string file ' <b>Stringfilename</b> '. You can load in maximum 8 String files with 1000 different strings in the maximum. Unter ' <a href="#">Stringfile</a> ' sind Details über deren Verwendung zu finden
Delete string file	<b>#VFD</b> 'Stringfilename'(Alle Stringdateien löschen)	Deletes the selected or all strings of file ' <b>Stringfilename</b> '.
Count strings of string files	<b>#VFC</b>	Sends the amount of strings given through the string files. A more precise description of the system response can be found in the chapter <a href="#">Responsens. (#HAR)(#VFC)</a>
Set string register	<b>#VSS</b> String-id, 'String', String(id + 1), String(id + 2)	Saves a string ' <b>String</b> ' in string register <b>String-id</b> . Additional strings are stored in the following registers. The length is 255 characters for each string register.
Set string register position	<b>#VSP</b> String-id, pos, 'String'	Saves a string ' <b>String</b> ' in string register <b>String-id</b> starting at position <b>pos</b> .
String register Date/Time	<b>#VSD</b> String-id, DateFormat(#WDF), Date32(datetime())	Uses the date format <b>DateFormat</b> to store time and date <b>Date32</b> in string register <b>String-id</b> .
Stringregister Formatstring	<b>#VSF</b> String-id, Formatstring (printf), Value1, Value2...	Saves a formatted string ' <b>Formatstring</b> ' in string register <b>String-id</b> with the help of <b>Value</b> . You can find details about ' <a href="#">formatted strings</a> ' here..
Copy object sting to string register	<b>#VSO</b> String-id, Object-id, Objekt(id+1), Objekt(id+2)	Writes a string of a object <b>Object-id</b> to string register <b>String-id</b> .
Read string register (ASCII)	<b>#VSA</b> String-id, String-id	Sends a string register <b>String-id</b> as ASCII. You can define a range of registers to send with '-'. E.g.g S1-S4, so register 1,2,3,4 are send. A more precise description of the system response can be found in the chapter <a href="#">Responsens. (#HAR)(#VSA)</a>
Read string register (Unicode)	<b>#VSU</b> String-id, String-id	Sends a string register <b>String-id</b> as unicode. You can define a range of registers to send with '-'. E.g.g S1-S4, so register 1,2,3,4 are send. A more precise description of the system response can be found in the chapter <a href="#">Responsens. (#HAR)(#VSU)</a>



Designation	Command code	Description
Set register (Integer)	<b>#VRI</b> Register-id, Integer, Integer(id +1)	Saves an integer value or calculation output <b>Integer</b> to register <b>Register-id</b> . Further values are stored in the following registers
Set register (Float)	<b>#VRF</b> Register-id, Float, Float(id +1)	Saves a float value or calculation output <b>float</b> to register <b>Register-id</b> . Further values are stored in the following registers
Read register Int/Float	<b>#VRG</b> Register-id, Register-id, Register-id	Sends a register <b>Register-id</b> value (integer/float). You can define a range of registers to send with '-'. E.g.g S1-S4, so register 1,2,3,4 are send. A more precise description of the system response can be found in the chapter <a href="#">Responsens. (#HAR)</a> ( <a href="#">#VRG</a> )

## MACROS

General information on macros can be found here.

Parameters that are written in **GREY** in the command tables are considered optional details, and partially have default values. The default values are given in brackets behind the corresponding parameters. Parameters written in **BLACK** on the other hand, must be assigned values. Commands that may contribute towards changing parameters can only be used if the corresponding parameters have already previously been defined. Some commands allow for entering several object IDs. Should these objects be in numerical sequence, the range may be specified with the "-" sign, e.g. 1-5, instead of 1,2,3,4,5.

## EXECUTING MACROS

Designation	Command code	Description
Execute macro	<b>#MRN</b> "Makroname"	The " <b>Macro Name</b> " macro (file name) is executed.
Execute macro with condition	<b>#MRC</b> Condition, "Makroname" true; "Makroname" false(Kein Makro)	The " <b>Macro Name</b> " macro (true) is executed if the condition <b>Condition</b> is fulfilled. Otherwise, ' <b>Macro Name</b> '(false) is executed.
Execute port macro	<b>#MRP</b> Port	The port macro for the port <b>Port</b> (0-15) is executed.
Execute bit macro	<b>#MRB</b> Bit, Edge	The bit macro for the bit <b>Bit</b> (0-127) with the flank <b>Edge</b> (0= Falling; 1= Increasing) is executed.
Execute touch macro	<b>#MRT</b> Object-id, TouchState	The touch macro, which is defined by the touch function <b>Touch State</b> (1= Not Pressed; 2= Pressed; 4= Drag) in the touch object <b>Object ID</b> , is executed.
End macro file prematurely	<b>#MFE</b> Condition(wahr)	Ends the macro prematurely if the condition <b>Condition</b> is fulfilled.
Skip macro file lines	<b>#MFS</b> Condition(wahr), Lines(1)	Skips lines <b>Lines</b> in the macro if the condition <b>Condition</b> is fulfilled.
Set macro file marker	<b>#MFM</b> Marker-nr(0)	Sets a marking in the macro file <b>Marker No.</b> (0-9).
Jump from macro file to marker	<b>#MFJ</b> Condition, Marker-nr(0)	Jumps to the previously defined marking <b>Marker No.</b> (0-9) if the condition <b>Condition</b> is fulfilled.
Delete macro definitions	<b>#MCD</b> Mask	Delete all macro definitions. Through <b>Mask</b> , it is established which group of macros is deleted (1=Second; 2= Process; 4= Port; 8= Bit; 16= Analogue; 32= Touch; 64= Operation). The addition of the individual flag in the Mask results in the combined deletion of the respective macro groups. Thus, when entering Mask=3, second and process macros are deleted.

**DEFINITION OF MACRO PROCESSES AND TOUCH MACROS**

Designation	Command code	Description
Macro process	<b>#MPD</b> Prozess-nr, Time, "Makroname"; , Startnr(Keine), Endnr(Startnr), Type(1)	Defines a process macro with the process number <b>Process No.</b> (1-10). The " <b>Macro Name</b> " macro is accessed at time intervals Time(hrs). Multiple macros can, optionally, be executed. For this purpose, the "Macro Name" needs to end with at least one figure. The start <b>Start Number</b> and end <b>End Number</b> macros are handed over as optional parameters, and equipped with an <a href="#">Animation Typen Type</a> (1-6). Should, for instance, Macro Name= Photo, StartNo.= 1, Time= 100 and End No.= 6 be used, then "Photo1"→"Photo2"→...→Photo6 will be accessed at intervals of a second.
Conditional macro	<b>#MPC</b> Prozess-nr, Conditiontime, Condition, "Makroname"; , Startnr(Keine), Endnr(Startnr), Type(1)	Defines a process macro with the process number <b>Process No.</b> (1-10). It is queried at the interval <b>ConditionTime</b> (hrs) whether the condition Condition is fulfilled. Should the <b>Condition</b> =TRUE, then the macro "Macro Name" is executed. The option exists to access multiple macros. For that purpose, the start and end macros are, as it were, give a <b>Start No.</b> and <b>End No.</b> , and equipped with a type of animation <b>Type</b> (1-6), <a href="#">see #MPD</a> .
Automatically changing macro	<b>#MPA</b> Prozess-nr, Calculationtime, Change, "Makroname"; , Startnr(Keine), Endnr(Startnr), Type(1)	Defines a process macro with the process number <b>Process No.</b> (1-10). The " <b>Macro Name</b> " macro is only accessed if there changes in value in the <b>Change calculation</b> . The calculation is always of the "Integer" data type. The time <b>Calculation Time</b> (hrs) determines the interval of the query of the calculation result. Should the current result have changed in comparison to the previous result, the "Macro Name" macro is executed. The option exists to access multiple macros. For that purpose, the start and end macros are, as it were, give a <b>Start No.</b> and <b>End No.</b> , and equipped with a type of animation Type(1-6), <a href="#">see #MPD</a> .
Change process time	<b>#MPT</b> Prozess-nr, Time	Changes the time <b>Time</b> (hrs) after which a macro is accessed in the process macro <b>Process No.</b> In order to be able to use this command, it is necessary to define a process macro in advance.

Designation	Command code	Description
Define port macro	<b>#MHP</b> Port, "Makroname"(delete old macro)	Should the status of the I/O pins of the port <b>Port</b> (0-15) be altered, the macro is accessed " <b>Macro Name</b> ". Should the command be executed without a " <b>Macro Name</b> ", the current macro definition is deleted.
Define bit macro	<b>#MHB</b> Bit, Edge, "Makroname"(delete old macro)	Defines the macro " <b>Macro Name</b> " for the port pin <b>Pin</b> (0-127) and the flank Edge (0= Falling; 1= Increasing). Should the command be executed without a " <b>Macro Name</b> ", the current macro definition is deleted.
Define analogue macro	<b>#MHA</b> Channel, AnalogType, "Makroname" (delete old macro)	Defines in the channel <b>Channel</b> (0-3) the " <b>Macro Name</b> " macro The Type of the analogue macro AnalogType needs to be taken into consideration in the process. Should the command be executed without a " <b>Macro Name</b> ", the current macro definition is deleted.
Define RTC second macro	<b>#MDS</b> , "Makroname" (delete old macro)	Accesses the macro " <b>Macro Name</b> " every second. Should the command be executed without a " <b>Macro Name</b> ", the current macro definition is deleted.
Define operation end macro	<b>#MDA</b> Object-id, "Makroname" (delete old macro)	Defines an end macro in the object <b>Object ID</b> . The "Macro Name" macro is only executed once the operation of the object has come to an end Object ID. Should the command be executed without a "Macro Name", the current macro definition is deleted.
Define touch macro	<b>#MDT</b> Object-id/Group-id, "Makroname down" (delete old macro); "Makroname up" (Altes Makro löschen), "Makroname drag" (Altes Makro löschen)	Defines a touch function in the object <b>Object ID</b> or in the object group <b>Group ID</b> . In that respect, " <b>Macro Name</b> " macros are specified for the <b>pressed</b> (down), <b>unpressed</b> (up) and <b>maintained</b> (drag) states. The corresponding object <b>Object ID</b> needs to be defined for the latter as a touch object. Should the command be executed without a " <b>Macro Name</b> ", the current macro definition is deleted.

## TYPES OF ANALOGUE MACROS

The hysteresis of the analogue channel set is observed. There is a description [here](#) of how to set the limits and the hysteresis..

Designation	Parameter	Description
Change	0	The macro is accessed with any changes in value.
Reduction	1	The macro is accessed when there are changes in value.
Increase	2	The macro is accessed when there are increases in value.
Fail to reach lower limit	3	The macro is accessed when failing to reach the lower limit.
Failing to reach lower limit	4	The macro is accessed when exceeding the lower limit
Failing to reach upper limit	5	The macro is accessed when failing to reach the upper limit.
Exceeding upper limit	6	The macro is accessed when exceeding the upper limit
Leaving the border window	7	The macro is accessed when leaving the window predefined by the two limits.
Entering the border window	8	The macro is accessed when entering the window predetermined by the two limits.

## TIME AND DATE

Parameters that are written in **GREY** in the command tables are considered optional details, and partially have default values. The default values are given in brackets behind the corresponding parameters. Parameters written in **BLACK** on the other hand, must be assigned values. Commands that may contribute towards changing parameters can only be used if the corresponding parameters have already previously been defined. Some commands allow for entering several object IDs. Should these objects be in numerical sequence, the range may be specified with the "-" sign, e.g. 1-5, instead of 1,2,3,4,5.

Designation	Command code	Description
Set time and date	<b>#WTD</b> Hour, Min(Alte Werte), Sec(Alte Werte), Day(Alte Werte), Month(Alte Werte), Year(Alte Werte)	Sets the time, hour <b>Hour</b> , minute <b>Min</b> and second <b>Sec</b> and date <b>Day</b> , month <b>Month</b> and year <b>Year</b> . The RTC is buffer with a coin battery 364.
Send time in binary format	<b>#WSB</b> Date32(Aktuelle Zeit)	Sends the actual time or the time given through <b>Date32</b> . A more precise description of the system response can be found in the chapter <a href="#">Responsens. (#HAR)(#WSB)</a>
Set format string for time	<b>#WDF</b> DateFormat	Sets the format of time and date. <b>DateFormat</b> als formatierter String ( <a href="#">Example</a> ) angegeben werden. Details about time string format are listed <a href="#">here</a>
Send time ASCII	<b>#WSA</b> DateFormat(#WDF), Date32(Aktuelle Zeit)	Sends the actual time or the time given through <b>Date32</b> in the date format <b>DateFormat</b> as ASCII. Date format commands are shown <a href="#">here</a> . A more precise description of the system response can be found in the chapter <a href="#">Responsens. (#HAR)(#WSA)</a>
Send time unicode	<b>#WSU</b> DateFormat(#WDF), Date32(Aktuelle Zeit)	Sends the actual time or the time given through <b>Date32</b> in the date format <b>DateFormat</b> as Unicode. Date format commands are shown <a href="#">here</a> . A more precise description of the system response can be found in the chapter <a href="#">Responsens. (#HAR)(#WSU)</a>
Define month names	<b>#WDM</b> 'Jan'(January); 'Feb'(February); 'Mar'(March); 'Apr'(April); 'May'(May); 'Jun'(June); 'Jul'(July); 'Aug'(August); 'Sep'(September); 'Okt'(October); 'Nov'(November); 'Dec'(December)	Defines the names for the months ' <b>Jan</b> ' - ' <b>Dec</b> '
Define month names	<b>#WDW</b> 'Mon'(Monday), 'Tue'(Tuesday), 'Wed'(Wednesday), 'Thu'(Thursday), 'Fri'(Friday), 'Sat'(Saturday), 'Sun'(Sunday)	Defines the names for the days ' <b>Mon</b> ' - ' <b>Sun</b> '.
Objectgroup as clock	<b>#WGC</b> Group-id, IndicatorH-id, IndicatorM-id, IndicatorS-id	Defines an object group <b>Group-id</b> as clock. To use the hour- <b>IndicatorH-id</b> , minute- <b>IndicatorM-id</b> or optionally the second <b>IndicatorS-id</b> indicator, objects of the groups must be assigned to it. <a href="#">Beispiel siehe S. 123</a>

## ACTION

Allgemeine Informationen zu Aktionen befinden sich [hier](#).

Parameters that are written in **GREY** in the command tables are considered optional details, and partially have default values. The default values are given in brackets behind the corresponding parameters. Parameters written in **BLACK** on the other hand, must be assigned values. Commands that may contribute towards changing parameters can only be used if the corresponding parameters have already previously been defined. Some commands allow for entering several object IDs. Should these objects be in numerical sequence, the range may be specified with the “-” sign, e.g. 1-5, instead of 1,2,3,4,5.

## OPERATIONAL CURVES AND PATHS

Designation	Command code	Description
Define operation curve	<b>#ACD</b> ActionCurve-Nr, X1, Y1, X2, Y2	The action curve describes the chronological course of an operation, e.g. accelerating and decelerating. What is defined is an operational curve <b>Operational Curve-No.</b> (1... 10) through the positions <b>X1, 2</b> (0... 100) and <b>Y1, 2</b> (-200...300).  For information on default curves and more precise explanations, see <a href="#">Pre-defined operational curves</a> .
Define operation path	<b>#APD</b> ActionPath-nr, StartX, StartY, Segment1, Segment2,...	Defines an operational path <b>action path</b> (1... 10) through the position <b>Xstart, Ystart</b> and the successive <a href="#">segments</a> . The operational path describes the way in which the operation is supposed to be performed.

## DEFINE ACTION

Designation	Command code	Description
Action define	<b>#ADC</b> Start/End	<b>Start/End</b> (Finish= 0; Start= 1) Commands which chronologically follow <b>#ADC1</b> are only executed if the definition of the operation is terminated by <b>#ADC0</b> . As a result, multiple objects or operations that are generated or are supposed to begin simultaneously can be defined.

## ACTION

Designation	Command code	Description
Define absolute action	<b>#AOA</b> Object-id, Action, Action2, ...	Defines an operation <b>action</b> for an object <b>Object ID</b> absolutely. For an explanation of the operations possible, see <a href="#">definition an action</a> .

Designation	Command code	Description
Define relative action	<b>#AOR</b> Object-id, Action, Action2, ...	Defines an operation <b>action</b> for an object <b>Object ID</b> relatively. For an explanation of the operations possible, see <a href="#">definition an action</a> .
Define type of action	<b>#AOT</b> Object-id, ActionType, TotalTime (100), DelayStart(0), DelayEnd(0)	Defines a type of action <b>Type of Action</b> for the object <b>Object ID</b> assigned, depending upon the total duration <b>TotalTime</b> (hs), the start <b>delay</b> DelayStart(hrs) and premature termination <b>DelayEnd</b> (hrs). An operation for the object Object ID needs to have been determined in advance for this command. For an explanation of the various types of operation, see <a href="#">type of operation</a>
Cancel action	<b>#AOS</b> Object-id, Stop(0), Next(0)	Defines the end of an operation <b>Stop</b> (0= Now; 1= Start of an operation; 2= End of an operation) and subsequent step <b>Next</b> (0= Stopping normally; 1= Jump; 2= Delete object) for the object assigned <b>Object ID</b> . An operation for the object Object ID needs to have been determined in advance for this command.



**DEFINE ACTIONS**

Designation	Parameter	Description
Position curve	<b>101-110</b> PosX, PosY	Defines the position <b>PosX</b> , <b>PosY</b> . The object is moved in a straight line to the point specified. <a href="#">Beispiel siehe S. 107</a>
Position curve path	<b>151-160</b> Actionpath-nr, Offset	The object follows the operational path <b>Action Path No.</b> , or is placed on the latter. The starting value <b>Offset</b> (0...100) determines the starting point on the operational path on a percentage basis. <a href="#">Beispiel siehe S. 107</a>
Scale curve	<b>201-210</b> ScaleX, ScaleY	Defines the size <b>ScaleX</b> , <b>ScaleY</b> as a percentage of the original size of the object. <a href="#">Beispiel siehe S. 107</a>
Scale curve path	<b>251-260</b> Actionpath-nr, Offset	The object is scaled over the operational path <b>ActionPath No.</b> The starting value <b>Offset</b> (0...100) determines the starting size on the operational path on a percentage basis. <a href="#">Beispiel siehe S. 107</a>
Rotation curve	<b>301-310</b> Angle	Defines the rotational angle <b>Angle</b> . Negative angle for rotation in a clockwise direction <a href="#">Beispiel siehe S. 108</a>
Rotation curve path	<b>351-360</b> Actionpath-nr, Offset	The object is rotated over the operational path <b>Action Path No.</b> The starting value <b>Offset</b> (0...100) determines the starting angle on the operational path on a percentage basis. <a href="#">Beispiel siehe S. 108</a>
Shear curve	<b>401-410</b> ShearX Shear Y	Defines a shearing <b>ShearX</b> , <b>ShearY</b> in degrees. <a href="#">Beispiel siehe S. 108</a>
Shear curve path	<b>451-460</b> Actionpath-nr, Offset	The object is sheared over the operational path <b>Action Path No.</b> The starting value <b>Offset</b> (0...100) determines the starting shearing on the operational path on a percentage basis.
Opacity curve	<b>501-510</b> Opacity	Defines the transparency <b>Opacity</b> (0..100). <a href="#">Beispiel siehe S. 109</a>
Colour offset curve	<b>601-610</b> Red, Green, Blue	Defines a colour addition of the colour components red <b>Red</b> (-100...100), green <b>Green</b> (-100...100) and blue <b>Blue</b> (-100...100). <a href="#">Beispiel siehe S. 109</a>

**ACTION TYPE**

Example on contemplating the types of operation

#AOT id, X, 100

The parameter "X" corresponds to the parameters of the types of operation in the following table.

Designation	Parameter	Description
Appearing	1	Defines an appearing behaviour for the operation selected. The object is generated at its generation point (400,240), depending upon the definition of the operation. That means that it will fly in from the position specified (1000,600), taking into account the size specified (25%), and be scaled to its original size.
Disappearing	2	Defines a disappearing behaviour for the operation selected. The course proceeds in the opposite direction to the appearance, in other words the object is moved from the position in which it is generated to the position specified with a corresponding change in its size. The object is subsequently deleted.
Invisible	3	Defines a fading out behaviour for the operation selected. The course is the same as that of the disappearing behaviour, however the object is not deleted after the operation, but becomes invisible. That means that it does not need to be re-defined for later uses
Change	4	Defines a one-off change in the parameters for the operation selected. The course is the same as that of the disappearing behaviour, however the object is not deleted after the operation.
Cyclical	5	Defines a cyclic behaviour for the operation selected. The course corresponds to the changing behaviour, however the latter is constantly repeated
Oscillating (ping-pong)	6	Defines an oscillating behaviour for the operation selected. The course resembles that of the cyclic behaviour, however with the difference that the object is not constantly moved from the point of its generation to the position specified, but always oscillates between the latter with the dimensioning specified.

**PRE-DEFINED ACTION CURVES**

The course of the operation can be defined in the case of the operational curves. The chronological course of 0 to 100% can be found on the X axis. The Y axis specifies the corresponding allocated value. The latter concerns a cubic spline with two supporting points. The EA uniSketch Windows program offers help in generating one's own curve.

Action curve	Curve points	Visualisation
1: Linear	$X1 = 10; Y1 = 10; X2 = 90; Y2 = 90$	<p>The graph displays a straight blue line on a coordinate system where both the x-axis and y-axis range from 0 to 100 with major grid lines every 10 units. The line starts at the origin (0,0) and extends diagonally to the top-right corner (100,100).</p>
2: Accelerating → linear	$X1 = 40; Y1 = 0; X2 = 60; Y2 = 40$	<p>The graph shows a blue curve that starts at (0,0) and increases with an upward curvature, ending at (100,100). The curve is concave up, indicating that the rate of change is increasing over time.</p>
3: Linear → reducing speed	$X1 = 40; Y1 = 60; X2 = 60; Y2 = 100$	<p>The graph displays a blue curve that starts at (0,0) and increases with a downward curvature, ending at (100,100). The curve is concave down, indicating that the rate of change is decreasing as it approaches the end point.</p>

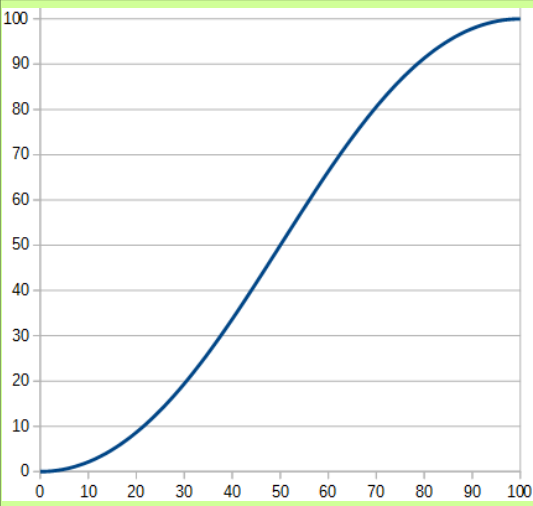
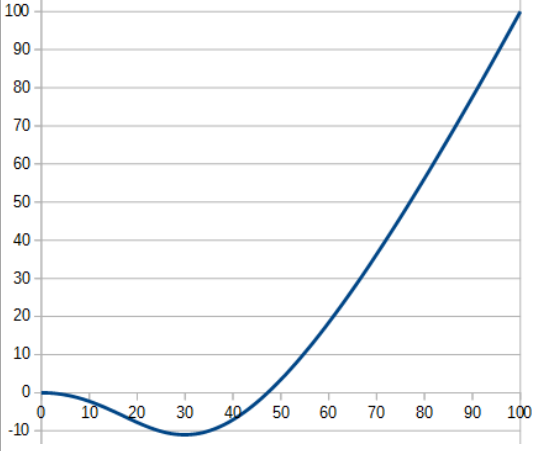
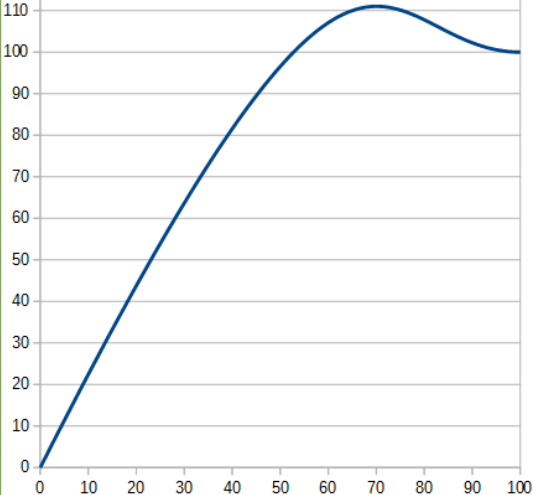
Action curve	Curve points	Visualisation
4: Accelerating → linear → reducing speed	$X1 = 40; Y1 = 0; X2 = 60; Y2 = 100$	
5: Undershooting → linear	$X1 = 30; Y1 = 0; X2 = 30; Y2 = -60$	
6: Linear → overshooting	$X1 = 70; Y1 = 160; X2 = 70; Y2 = 100$	

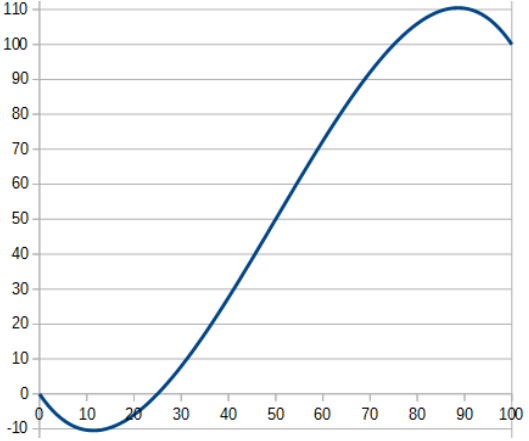
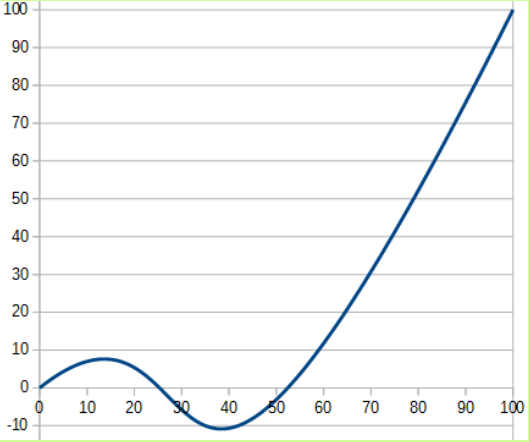
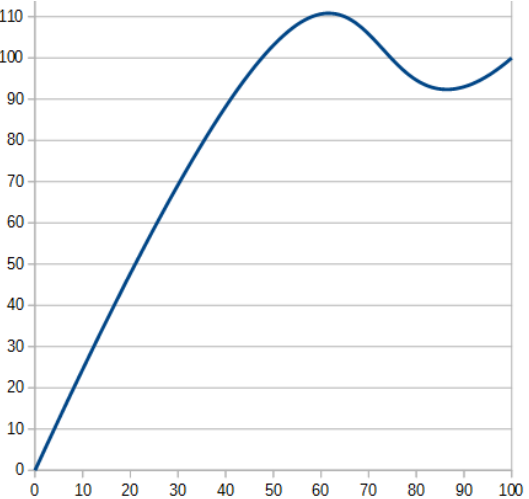
Action curve	Curve points	Visualisation
7: Undershooting → linear → overshooting	<b>X1 = 30; Y1 = -60; X2 = 70; Y2 = 160</b>	
8: Oscillating → linea	<b>X1 = 40; Y1 = 40; X2 = 20; Y2 = -100</b>	
9: Linear → oscillating	<b>X1 = 80; Y1 = 200; X2 = 60; Y2 = 60</b>	

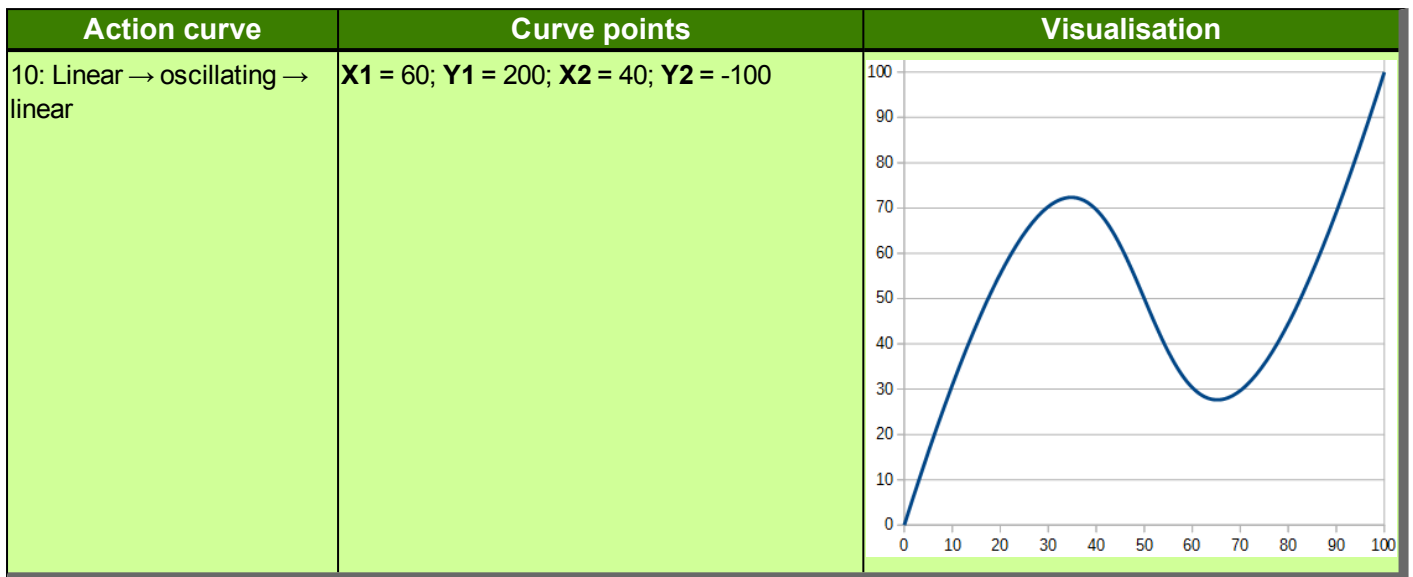

## KEYBOARD

To generate special keys, such as *Shift*, *Backspace* or *CAPSLOCK*, corresponding parameters need to be set in the "Button String". So that the parameters find their application, a *Backslash* '\' needs to be placed in front of them.

The "Button String" command describes the sequence of the keys within a line. In order to insert more lines, the latter need to be separated by entering '|' or ';' at the end of the line.

Parameters that are written in **GREY** in the command tables are considered optional details, and partially have default values. The default values are given in brackets behind the corresponding parameters. Parameters written in **BLACK** on the other hand, must be assigned values. Commands that may contribute towards changing parameters can only be used if the corresponding parameters have already previously been defined. Some commands allow for entering several object IDs. Should these objects be in numerical sequence, the range may be specified with the "-" sign, e.g. 1-5, instead of 1,2,3,4,5.

Parameter	Description
\1: (code 1)	Show Keyboard No. 1.
\2: (code 2)	Show Keyboard No. 2.
\3: (code 3)	Show Keyboard No. 3.
\4: (code 4)	Show Keyboard No. 4.
\5: (code 5)	<b>ShiftKey</b> switches over to Keyboard No. 2. Once a key has been entered, there is an automatic return to Keyboard No. 1.
\6: (code 6)	Switch over to <b>CapsLockKey</b> between Keyboard No. 1 and Keyboard No. 2.
\7: (code 7)	<b>Delete</b> deletes the characters to the right of the cursor.
\8: (code 8)	<b>BACKSPACE</b> deletes the characters to the left of the cursor.
\A: (code 10)	Move to the beginning of the next line; <i>reserved for future use</i>
\B: (code 11)	<b>Insert / Overwrite</b> switches between inserting text and overwriting text.
\C: (code 12)	<b>CLEAR</b> deletes the entire entry.
\D: (code 13)	<b>Enter / Return</b> confirms the entry and sets the entry as a new default string ( <a href="#">#SED</a> ).
\E: (code 14)	Left arrow key
\F: (code 15)	Rightarrow key
\G: (code 16)	Up arrow key; <i>reserved for future use</i>
\H: (code 17)	DownUp arrow key; <i>reserved for future use</i>
\I: (code 18)	<b>Pos1</b> jumps to the beginning of the entry.
\J (code 19)	<b>Ende</b> jumps to the end of the entry.
\L: (code 21)	<b>Escape</b> breaks off the entry and returns to the default string( <a href="#">#SED</a> ).
\N: (code 23)	Placeholder for an unused and not yet defined key.
\O..\V: (code 24 .. 31)	8 x function keys



Designation	Command code	Description
Define keys	<b>#KDB</b> Group-id, Nr, "ButtonStringLine1", "ButtonStringLine2"...	Defines as an object group <b>Group ID</b> the key sequence of the keyboard " <b>Button String Line</b> ", depending upon the keyboard number No. and the sequence of the keys. Further key sequences may be specified. Should the same key be entered several times in a row, then the width of the key generated changes in proportion. The latter shall also apply to spaces. <a href="#">Beispiel siehe S. 114</a>
Define alternative labelling	<b>#KDL</b> Group-id, Code," ButtonText"	Changes the labelling " <b>Button Text</b> " in the object group <b>Group ID</b> with the special <b>Code</b> keys <a href="#">Beispiel siehe S. 114</a>
Define styles	<b>#KDC</b> Group-id, Gap, ButtonStyle1 normal, ButtonStyle 1 special, Button Style2 normal, ButtonStyle2 special...	Defines for the object group <b>Group ID</b> the spacing between keys <b>Gap</b> , as well as the button style for normal <b>ButtonStyle normal</b> and special <b>ButtonStyle special</b> .keys A maximum of five button style pairs can be entered. The numbers of the button style specify the key length for which the style is effective. <a href="#">Beispiel siehe S. 114</a>
Place keyboard	<b>#KPK</b> Group-id, PosX, PosY, Anchor, Width, Height	Positions the object group <b>Group ID</b> , depending upon the position, <b>PosX</b> , <b>PosY</b> , the anchor <b>Anchor</b> and the width <b>Width</b> . Entering the height <b>Height</b> is optional. <a href="#">Beispiel siehe S. 114</a>

## EA uniTFT Vorläufig

### PERIPHERALS - INTERFACE

The module has various interfaces:

- 4 [analogue inputs](#) (12-bit precision)
- 1 [PWM](#) output (16-bit precision)
- [Video input](#) (PAL/SECAM Analogue)
- [Audio output](#) (8-ohm loudspeaker, max. 1 W)
- 16 digital [I/O](#), extendable to up to 128 (max. 20 mA)
- 3 serial interfaces [RS232](#), [SPI](#), [I<sup>2</sup>C](#)

Parameters that are written in **GREY** in the command tables are considered optional details, and partially have default values. The default values are given in brackets behind the corresponding parameters. Parameters written in **BLACK** on the other hand, must be assigned values. Commands that may contribute towards changing parameters can only be used if the corresponding parameters have already previously been defined. Some commands allow for entering several object IDs. Should these objects be in numerical sequence, the range may be specified with the “-” sign, e.g. 1-5, instead of 1,2,3,4,5.

### ANALOGUE

Designation	Command code	Description
Calibrate analogue converter	<b>#HAC</b>	Executes the calibration of the analogue converter.
Analogue input - hysteresis	<b>#HAH</b> Channel, Hysteresis (1)	Defines the hysteresis of the analogue input <b>Channel</b> (0-3). Not all changes in value are displayed by specifying hysteresis Hysteresis, but only changes in value as from the size specified. If the hysteresis is not specified, all changes in value are displayed, i.e. <b>Hysteresis</b> = 1.
Read analogue input	<b>#HAL</b> Channel, Limit, Limit2	Defines an upper and lower limit <b>Limit</b> , <b>Limit 2</b> for the analogue input <b>Channel</b> (0-3).
Read analogue input	<b>#HAR</b> Channel(0), Number(4)	Scans the analogue input <b>Channel</b> (0-3). The number <b>Number</b> (1-4) specifies the number of inputs to be read. Example: Channel = 1, Number = 2 leads to the analogue inputs 1 and 2 being scanned, and displayed via the serial interface. A more precise description of the system response can be found in the chapter <a href="#">Responsens.</a> <a href="#">(#HAR)</a> <a href="#">(#HAR)</a>

**PULSE WIDTH MODULATION (PWM)**

Designation	Command code	Description
PWM output frequency	<b>#HFO</b> Frequency32Bit , OnTime(no change), TotalTime(no change)	Defines the frequency <b>Frequency</b> (2Hz-1MHz) of the PWM output. Internal splitters lead to not every frequency being precisely adjustable. The ratio of on time to off time is determined by the two parameters <b>OnTime/TotalValue</b> . <a href="#">Beispiel siehe S. 111</a>
Duty cycle - PWM output	<b>#HFD</b> OnTime, TotalTime(no change)	Changes the ratio of on time to off time <b>OnTime/TotalValue</b> .

**PORT**

Designation	Command code	Description
Port setting	<b>#HPC</b> Port, I/O, ...	Setting for the entire port(0-15). In this context, <b>I/O</b> (0-0xFF) defines the respective port bit as an input (1) or output (0). Further specifying <b>I/O</b> defines the next higher value port. <a href="#">Beispiel siehe S. 111</a>
Set outputs	<b>#HPW</b> Port, PortState, ...	Bring output of the component <b>Port</b> into the <b>PortState</b> state (0-255). Further details of PortState describe the next port component. <a href="#">Beispiel siehe S. 111</a>
Read inputs	<b>#HPR</b> Port(0), Number(2)	Scans the port component <b>Port</b> (0-15). Multiple port components can be read with the number <b>Number</b> (1-16). As the standard, two port components exist. A more precise description of the system response can be found in the chapter <a href="#">Responsens. (#HAR)</a> ( <a href="#">#HPR</a> )
Information on the port module	<b>#HPI</b>	Return of the connected port components. A more precise description of the system response can be found in the chapter <a href="#">Responsens. (#HAR)</a> ( <a href="#">#HPI</a> )
Port pin setting	<b>#HBC</b> Pin, Output/Input, ...	Determines whether the port pin <b>Pin</b> (0-127) is defined as an input or output <b>Output/Input</b> (0= Output; 1= Input). Further specifying Output/Input defines the next higher value <b>Pin</b> .
Set port pin output	<b>#HBW</b> Pin, BitState, ...	Describes the <b>Bit State</b> state (0, 1, 2= invert) of the output pin <b>Pin</b> (0-127). Further specifying Bit State defines the state of the next higher value <b>Pin</b> .

Designation	Command code	Description
Read port pin input	#HBR Pin(0), Number(16)	Scans the port pin <b>Pin</b> (0-127). Multiple port components can be scanned with the number <b>Number</b> (1-128). A more precise description of the system response can be found in the chapter <a href="#">Responsens. (#HAR)</a> (#HBR)

## VIDEO AND AUDIO

Designation	Command code	Description
Play sound	#HTP "Soundname"	Plays back the sound file with the name <b>Sound Name</b> . Only *.esd files can be played back. The easiest way to create these files is using the EA uniSketch Win-dEA uniSketch.
Stop sound	#HTS	Stops the playback of the sound file.
Video input window	#HVB Left(0), Top(0), Width(720), Height (576)	Window setting of the video input with left <b>Left</b> and top <b>Top</b> offset, as well as width <b>Width</b> and height <b>Height</b> .

## RS232 MASTER INTERFACE

Designation	Command code	Description
Send ASCII	#HRA "string"	Sends a text ' <b>string</b> ' via the RS232 Master Interface as ASCII code.
Send Unicode	#HRU "string"	Sends a text ' <b>string</b> ' via the RS232 Master Interface as Unicode.
Send binary code	#HRS len32Bit, Data	Sends binary data <b>data</b> having the length <b>len</b> via the RS232 Master Interface. The length needs to be under 1 kB.
Send file	#HRF <Filename>	Sends a file < <b>Filename</b> > via the RS232 Master Interface.
Data received	#HRR len32Bit (1024)	Scans the length <b>len</b> of the data received via RS232. The maximum length permitted is 1 kB. If the length is greater than the available data, only the latter are transmitted. A more precise description of the system response can be found in the chapter <a href="#">Responsens. (#HAR)</a> (#HRR)

Designation	Command code	Description																		
RS232 parameter	#HRP Baudrate32Bit	Baud rate setting <b>Baud rate</b> of the master RS232 interface with 8-N-1. Baud rates:																		
		<table border="1"> <thead> <tr> <th>Baudrates</th> <th>Error rate in %</th> </tr> </thead> <tbody> <tr> <td>9600</td> <td>+0,04</td> </tr> <tr> <td>19200</td> <td>-0,08</td> </tr> <tr> <td>38400</td> <td>+0,16</td> </tr> <tr> <td>57600</td> <td>-0,08</td> </tr> <tr> <td>115200</td> <td>+0,64</td> </tr> <tr> <td>230400</td> <td>-0,80</td> </tr> <tr> <td>460800</td> <td>+2,08</td> </tr> <tr> <td>921600</td> <td>-3,68</td> </tr> </tbody> </table>	Baudrates	Error rate in %	9600	+0,04	19200	-0,08	38400	+0,16	57600	-0,08	115200	+0,64	230400	-0,80	460800	+2,08	921600	-3,68
Baudrates	Error rate in %																			
9600	+0,04																			
19200	-0,08																			
38400	+0,16																			
57600	-0,08																			
115200	+0,64																			
230400	-0,80																			
460800	+2,08																			
921600	-3,68																			

## SPI MASTER INTERFACE

Designation	Command code	Description
Send ASCII	#HSA "string"	Sends a text ' <b>string</b> ' via the SPIMaster Interface as ASCII code.
Send Unicode	#HSU "string"	Sends a text ' <b>string</b> ' via the SPI Master Interface as Unicode.
Send binary code	#HSS len, Data	Sends binary data <b>data</b> having the length <b>len</b> via the SPI Master Interface. The length needs to be under 1 kB.
Send file	#HSF <Filename>	Sends a file < <b>Filename</b> > via the SPI Master Interface.
Data received	#HSR len32Bit	Scans the length <b>len</b> of the data received via RS232. The maximum length permitted is 1 kB. If the length is greater than the available data, only the latter are transmitted. A more precise description of the system response can be found in the chapter <a href="#">Responsens. (#HAR)(#HRR)</a>
CS pin setting	#HSC State	Setup of the CS line: <b>State</b> (0=low (manually); 1=high (manually); 2=automatic)).

Designation	Command code	Description
SPI parameter	<b>#HSP</b> Frequency32Bit (in Hz), SPI Mode, DataOrder	Defines the parameters of frequency <b>Frequency</b> (15.6kHz-1MHz), mode <b>SPI Mode</b> (0-3) and data sequence <b>Dataorder</b> (0=MSB (Most Significant Bit)) of the SPI. The clock frequency is set to the Frequency, in regard to which internal splitters lead to the actual frequency always being the same or slower. Information on the SPI specification can be found <a href="#">here</a> .

I<sup>2</sup>C

Designation	Command code	Description
Send ASCII	#HIA "string"	Sends a text ' <b>string</b> ' via the I <sup>2</sup> C Master Interface as ASCII code.
Send Unicode	#HIU "string"	Sends a text ' <b>string</b> ' via the I <sup>2</sup> C Master Interface as Unicode.
Send binary code	#HIS len32Bit, Data	Sends binary data <b>data</b> having the length <b>len</b> via the I <sup>2</sup> C Master Interface. The length needs to be under 1 kB.
Send file	#HIF <Filename>	Sends a file < <b>Filename</b> > via the SPI Master Interface.
Data received	#HIR len32Bit	Scans the length <b>len</b> of the data received via RS232. The maximum length permitted is 1 kB. If the length is greater than the available data, only the latter are transmitted. A more precise description of the system response can be found in the chapter <a href="#">Responsens. (#HAR)#HRR</a>
I <sup>2</sup> C Parameter	#HIP Adress8Bit, Frequency32Bit	Defines the parameters of address Address and frequency Frequency(3.9kHz-1MHz) for the I <sup>2</sup> C transmission. Information on the I <sup>2</sup> C specification can be found <a href="#">here</a> .

## SYSTEM COMMANDS

Parameters that are written in **GREY** in the command tables are considered optional details, and partially have default values. The default values are given in brackets behind the corresponding parameters. Parameters written in **BLACK** on the other hand, must be assigned values. Commands that may contribute towards changing parameters can only be used if the corresponding parameters have already previously been defined. Some commands allow for entering several object IDs. Should these objects be in numerical sequence, the range may be specified with the “-” sign, e.g. 1-5, instead of 1,2,3,4,5.

Bezeichnung	Befehlscode	Beschreibung
Define project path	<b>#XPS</b> </Absolute path>	Defines the project path. Information on the path details can be found <a href="#">here</a> .
Read project path	<b>#XPG</b>	Writes the current project path into the transmission buffer. A more precise description of the system response can be found in the chapter <a href="#">Responsens. (#HAR) (#XPG)</a> .
Send version	<b>#XIV</b>	Writes the version string into the transmission buffer. A more precise description of the system response can be found in the chapter <a href="#">Responsens. (#HAR) (#XIV)</a> .
Display info	<b>#XID</b>	Writes the display parameters, such as the width and height, into the transmission buffer. A more precise description of the system response can be found in the chapter <a href="#">Responsens. (#HAR) (#XID)</a>
SD Card info	<b>#XIS</b>	Writes information on the SD card into the transmission buffer. A more precise description of the system response can be found in the chapter <a href="#">Responsens. (#HAR) (#XIS)</a>
RAM info	<b>##XIR</b>	Writes information on the internal RAM into the transmission buffer.. A more precise description of the system response can be found in the chapter <a href="#">Responsens. (#HAR) (#XIR)</a>
Display orientation	<b>#XCO</b> Angle	Changes the <b>angle</b> Angle(0, 90, 180, 270) for aligning the display.
Define virtual display resolution	<b>#XCV</b> Width(Displaywidth), Height(Displayheight), Touchwidth(Width), Touchheight(Height)	Defines the virtual display resolution through the width <b>Width</b> , height <b>Height</b> , touch width <b>Touchwidth</b> and touch height <b>Touchheight</b> . It is therefore possible for the size of programs to be adjusted to small and large displays automatically.
Define display brightness	<b>#XCB</b> Brightness, Time, Flash	Defines the brightness <b>Brightness</b> (0-100) of the display, making reference to the modification time <b>Time</b> (hrs). The value can be saved permanently. <b>Flash</b> 0= Do not save; 1= Save.



Bezeichnung	Befehlscode	Beschreibung
RS232 slave parameter	<b>#XCR</b> Baudrate, RS485 Adress(no change), Flash(0)	Defines the parameters for the RS232 slave: <b>Baud rate</b> (default = 115200) and RS485 Address (default = 7). The value can be saved in the flash memory <b>Flash</b> (0= Do not save; 1= Save). The format for the data transmission is 8-N-1. Dhe available baud rates are listed <a href="#">here</a> .
SPI slave parameter	<b>#XCS</b> SPI-Mode, DataOrder(no change), Flash(0)	Setting the <b>SPI modes</b> (0-3) (default = 3) and bit sequence <b>DataOrder</b> (0= MSB First; 1= LSB first) (default= 0). he value can be saved permanently. <b>Flash</b> 0= Do not save; 1= Save. Informatione on the SPI-Mode can be found <a href="#">here</a> .
I <sup>2</sup> C slave adress	<b>#XCI</b> Adress8Bit, Flash(0)	Set I <sup>2</sup> C slave address 8-bit <b>address</b> (default 0xDE). The value can be saved permanently. <b>Flash</b> 0= Do not save; 1= Save..
ASCII string to sending buffer	<b>#XSA</b> 'String'	Transmits the character string ' <b>String</b> ' to the transmission buffer as an ASCII string. This command is intended for displaying the <a href="#">Stringregister</a> .
Unicode string to sending buffer	<b>#XSU</b> 'String'	Transmits the character string ' <b>String</b> ' to the transmission buffer as an Unicode string. This command is intended for displaying the <a href="#">Stringregister</a> .
Hard copy to file	<b>#XHF</b> <File>, PictureFormat(1), x(0), y(0), Anchor (7), width (display width), height (display height)	ave screenshot in the PictureFormat format, and the dimensions x, y, anchor, width, height under the File path and nameGeneral information on the picture format can be found <a href="#">here</a> .
Hard copy to serial interface	<b>#XHS</b> PictureFormat(1), x1(0), y1(0),Anchor (7), width (display width - 1), height (display height -1)	Save screenshot in the <b>PictureFormat</b> format, and place the dimensions <b>x, y, width, height</b> in the transmission buffer. General information on the picture format can be found <a href="#">here</a> .
Hardcopy of video image to file	<b>#XVF</b> <File>, , PictureFormat	Save still image of the video window in the <b>PictureFormat</b> format under the <b>File path</b> and name.Save file. General information on the picture format can be found <a href="#">here</a> .
Hardcopy of video image to serial interface	<b>#XVS</b> PictureFormat	Place still image of the video window in the PictureFormat format into the sending buffer.IGeneral information on the picture format can be found <a href="#">here</a> .

Bezeichnung	Befehlscode	Beschreibung								
Interrupt program sequence	<b>#XXW</b> Wait	Stops the program sequence for the duration of the waiting period Wait(hrs). This command is suitable for debugging purposes. The module works does not process any further commands during this period.								
Touch adjustment (only resistive)	<b>#XXT</b>	Starts the adjustment of the resistive touch. The user needs to touch two predefined points on the screen.								
Firmware reboot (HW-Reset)	<b>#XFB</b> Option	The command executes a complete restart of the module. The parameter <b>Option</b> selects the boot mode::  <table border="0"> <tr> <td>1 Testmode</td> <td>Display parameters and information of the module on the display.</td> </tr> <tr> <td>2 Disable PowerOnMacro</td> <td>Deactivates the start of the PowerOn macro (start emc).</td> </tr> <tr> <td>3 Disable Default</td> <td>Deactivates all standard macros. No default settings are loaded.</td> </tr> <tr> <td>4 Bootmenu</td> <td>All projects to be found on the SD card are listed, and can be started.</td> </tr> </table>	1 Testmode	Display parameters and information of the module on the display.	2 Disable PowerOnMacro	Deactivates the start of the PowerOn macro (start emc).	3 Disable Default	Deactivates all standard macros. No default settings are loaded.	4 Bootmenu	All projects to be found on the SD card are listed, and can be started.
1 Testmode	Display parameters and information of the module on the display.									
2 Disable PowerOnMacro	Deactivates the start of the PowerOn macro (start emc).									
3 Disable Default	Deactivates all standard macros. No default settings are loaded.									
4 Bootmenu	All projects to be found on the SD card are listed, and can be started.									

## BOOT MENU AND TOUCH ADJUSTMENT THROUGH GESTURES

Both the resistive touch adjustment **#XXT**) and the boot menu **#XFB** can be accessed via two different gestures at the time of the restart.

For that purpose, directly at the start of the display (max. 1 second later), the latter needs to be pressed with a finger until the confirmation is obtained. After a further second, a message is displayed about whether a touch adjustment is supposed to take place or the boot menu is supposed to be accessed.

Should the touch adjustment take place, the finger needs to be briefly lifted, and then pressed on the display again, until the request for adjustment comes. This is the pressing of two points on the display.

Should, on the other hand, the boot menu start, the finger needs to be briefly lifted and subsequently pressed on the display twice at brief intervals.

Should neither of the two things occur, the finger may either remain on the display or be removed from the display.

The boot menu can be seen in the figure below.



The boot menu is divided into three areas.

On the left are the various projects that can be started by dialling.

On the lower right-hand side all macros can be deactivated, the test mode started or the accessing of the boot menu interrupted.

On the right-hand side at the top, the option of a one-off or permanent (saved) accessing of the corresponding selection is selected by pressing.

## FILE ACCESS

Parameters that are written in **GREY** in the command tables are considered optional details, and partially have default values. The default values are given in brackets behind the corresponding parameters. Parameters written in **BLACK** on the other hand, must be assigned values. Commands that may contribute towards changing parameters can only be used if the corresponding parameters have already previously been defined. Some commands allow for entering several object IDs. Should these objects be in numerical sequence, the range may be specified with the “-” sign, e.g. 1-5, instead of 1,2,3,4,5.

## SD-CARD

The options for specifying the path are listed [here](#).  
General information on the SD card can be found [here](#).

Designation	Command	Description
Set working path	<b>#FDS</b> <Path>	Defines the working path <b>Path</b> . When relative paths are specified, this folder is taken as the basis.
Reading back working path	<b>#FDG</b>	Read working path. A more precise description of the system response can be found in the chapter <a href="#">Responsens. (#HAR) (#FDG)</a>
List directory completely	<b>#FDR</b> <Path> (Arbeitspfad)	Listing the files and folders that exist in the path <b>Path</b> . A more precise description of the system response can be found in the chapter <a href="#">Responsens. (#HAR) (#FDR)</a>
List directory completely in the ASCII format	<b>#FDA</b> <Path> (Arbeitspfad)	Listing the files and folders that exist in the path <b>Path</b> . They are displayed in ASCII format. A more precise description of the system response can be found in the chapter <a href="#">Responsens. (#HAR) (#FDA)</a>
List directory folders	<b>#FDL</b> <Path> (Arbeitspfad)	Listing the folders that exist in the <b>Path</b> . A more precise description of the system response can be found in the chapter <a href="#">Responsens. (#HAR) (#FDL)</a>
Create directory	<b>#FDC</b> <Path>	Create new directory in the working directory <b>Path</b> .
Delete directory	<b>#FDD</b> <Path>, Content(0)	Delete content <b>Content</b> (0= Content only; 1= Folder and content) in the working directory <b>Path</b> .
Open/create file for writing	<b>#FWO</b> <Path + Filename>, Pos (0)	Open file with the name <b>File Name</b> for writing, optionally specifying the path <b>Path</b> at the position <b>Pos</b> . If the file does not exist, it is created.
Write content into file	<b>#FWD</b> Num, Data	Describes the opened and writeable file with the number <b>Num</b> of binary values <b>Data</b> .
Write (ASCII) content into file	<b>#FWA</b> "String"	The ascii string <b>String</b> is written into the open file.

Designation	Command	Description
Write (Unicode) content into file	#FWU "String"	The Unicode string <b>String</b> is written into the open file..
Close writeable file	#FWC	Closes the file that is presently open and writeable.
Open file for reading	#FRO <Path + Filename>, Pos (0)	Open file with the name <b>File Name</b> for reading, optionally specifying the path <b>Path</b> at the position <b>Pos</b> .
Read content of file	#FRD Anz (gesamtes File)	Reads the content of the open and readable file. A more precise description of the system response can be found in the chapter <a href="#">Responsens. (#HAR)(#FRD)</a>
Close file for reading	#FRC	Closes the file that is presently open and readable.
Delete file	#FFD <Path + Filename>	Delete file
Info on file/directory	#FFI <Path (Arbeitsverzeichnis)>	transmits information on the current direction/file <b>Path</b> . A more precise description of the system response can be found in the chapter <a href="#">Responsens. (#HAR)(#FFI)</a>
Change file/directory name	#FFR <Path>, <NewName>, Replace(0)	Changes the name of the file or directory at the location <b>Path</b> with the new designation <b>NewName</b> . Should another file exist with the same name, the behaviour is defined by <b>Replace</b> (0= Only change if the file does not already exist; 1= Always change → Other file is deleted).
Copy file/directory	#FFC <PathOld>, <PathNew>, Replace(0)	Copies the file or directory from the original location <b>PathOld</b> to the new location <b>PathNew</b> . If a file with the same name exists, the behaviour is defined by <b>Replace</b> (0= Copy if file does not already exist; 1= Overwrite).
Move file/directory	#FFM <PathOld>, <PathNew>, Replace(0)	Shifts the file or directory from the original location <b>PathOld</b> to the new location <b>PathNew</b> . If a file with the same name exists, the behaviour is defined by <b>Replace</b> (0= Shift if file does not already exist; 1= Overwrite).
File/directory Time stamp	#FFT <Path>, time, date	The time stamp is comprised of the <b>time</b> and <b>date</b> together. .For an explanation on file time, e <a href="#">see p. 102.</a>

Designation	Command	Description
File/directory Change properties	<b>#FFA</b> <Path>, Fileattribute	Sets a new attribute for the <b>Path</b> file specified. The <b>File Attribute</b> parameter is designed as follows: Write-protected                    0x01 Hidden                                0x02 System                                0x04 Archive                                0x20 The flag attributes can be combined through simple bit ORing.
Saving a uniTFT file	<b>#FSO</b> <Path>, File-Data	Saves an object file of the uniTFT's (e.g. *.epg) in the specified path <b>Path</b> .
Load file names into string register	<b>#FNF</b> <Path> (Arbeitsverzeichnis)	Saves the number in Register R1 and the name of the files in S1, S2, ... from the destination folder <b>Path</b> . S. number Should, for example, the two directories "Project1" and "Project2" be present in the destination folder, as well as the file "start.emc", the number "1" is saved in Register R1, and the "start" string in the String Register S1.
Load directory names into string register	<b>#FND</b> <Path> (Arbeitsverzeichnis)	Saves the number in Register R1 and the names of the folders in S1, S2, ... from the destination folder <b>Path</b> . S. number Should, for example, the two directories "Project1" and "Project2" be present in the destination folder, as well as the file "start.emc", the number "2" is saved in the register R1, the "Project1" string in the String Register S1 and the "Project2" string in the String Register S2.

**FILE TIME**

The file time is comprised of the date and time together. In the FAT file system, the time specification has a resolution of 2 s, calculated as from 00:00:00 hours on 01/01/1980.

Bit	15	14	13	12	11	10	9	8	7	6	5	4	3	2	1	0
Date	JYear, counting from 1980 (0..127)						Month(1..12)			Day(1..31)						
Time	Hour(0..23)					Minute (0..59)					Second/2 (0..29)					

Brief example for converting the time:

Date = ((Year-1980)<<9) + (Month<<5) + Day;

Time =(Hour<<11) + (Minute<<5) + (Second>>1);

## RESPONSES

General information on macros can be found here..

Parameters that are written in **GREY** in the command tables are considered optional details, and partially have default values. The default values are given in brackets behind the corresponding parameters. Parameters written in **BLACK** on the other hand, must be assigned values. Commands that may contribute towards changing parameters can only be used if the corresponding parameters have already previously been defined. Some commands allow for entering several object IDs. Should these objects be in numerical sequence, the range may be specified with the "-" sign, e.g. 1-5, instead of 1,2,3,4,5.

Designation	Command code	Description
Send version	<b>#XIV</b> String, 0	Returns the current version as a <b>string</b> . (←XIVEA uniTFT V1.0)
Display info	<b>#XID</b> Width 16Bit, Height 16Bit, Colordepth 8Bit, Touch 8Bit, Videowidth 16Bit, Videoheight 16Bit	Returns the width <b>Width</b> , height <b>Height</b> , colour depth <b>Colour depth</b> (16-bit/24-bit), touch control function, <b>Touch</b> (0 = No touch control; 3 = resistive; 7 = capacitive; 15 = PC mouse) and the dimensions of the video image through the latter's width, <b>Video Width</b> and height, <b>Video Height</b> . Should the value 1 (top/bottom) or 2 (left/right) be returned when using Touch, then the other respective directional value is missing.
RAM info - byte	<b>#XIR</b> Gesamt RAM 32Bit, Frei RAM 32Bit	Return of the overall and available memory on the SD card in KB.
SD Card info in KB	<b>#XIS</b> Gesamt SD 32Bit, Frei SD 32Bit	Rückgabe des Gesamt- und freien Speichers auf der SD-Karte in KB.
Time in binary code	<b>#WSB</b> Hour 16Bit, Min 16Bit, Sec 16Bit, Day 16Bit, Month 16Bit, Year 16Bit, Week-day 16Bit	Returns the time and date in hours <b>Hours</b> , minutes, <b>mins</b> , and seconds, <b>Secs</b> , day <b>Day</b> , month <b>Month</b> , year <b>Year</b> and week-day <b>Weekday</b> (0=Sunday).
Time - ASCII	<b>#WSA</b> String, 0=Ende	Returns the time and date as a <b>string</b> in ASCII code. (e.g. "#WSA08:30:36\n Tuesday, 3 May 2016")
Time in Unicode	<b>#WSU</b> UnicodeString, 0=Ende	Returns the time and date as a <b>string</b> in Unicode code. (e.g. "#WSU08:30:36\n Tuesday, 3 May 2016")
Retain project path	<b>#XPG</b> String, 0	Returns the project path as a <b>string</b> .
Hard copy to serial interface	<b>#XHS</b> Bitmap Header, Data	Sends a screenshot to the serial interface.
Retain working directory	<b>#FDG</b> String, 0, 0=Ende	Displays the working directory as a <b>string</b> .

Designation	Command code	Description
Read directory	<b>#FDR</b> NameString , 0, Filesize 32Bit, File-attribute8Bit, Modified Time 16Bit, Modified Date16Bit, ..., ..., 0=ENDE	Reads the content of the directory with name <b>Name String</b> , size <b>File Size</b> and properties, <b>File Attributes</b> . The file attributes can be combined through bit ordering. Write-protected 0x01 Hidden 0x02 System 0x04 Archive 0x20
Read directory (ASCII)	<b>#FDA</b> SizeString, Datestring, Timestring, Namestring, 0x0D, 0x0A, ..., ..., 0=ENDE	Reads the content of the directory as ASCII code with size <b>Size String</b> , date <b>Date String</b> , time Time String and name <b>Name String</b> .
List directories	<b>#FDL</b> Namestring, 0, Namestring, ..., 0=ENDE	Lists the directories with the name <b>Name String</b> .
Info on directories	<b>#FFI</b> NameString , 0, Filesize 32Bit, File-attribute8Bit, Modified Time 16Bit, Modified Date16Bit, ..., ..., 0=ENDE	Displays information on the directory with name, <b>Name String</b> , size, <b>File Size</b> and properties, <b>File Attributes</b> . The file attributes can be combined through bit ORing. Write-protected 0x01 Hidden 0x02 System 0x04 Archive 0x20
Read file content	<b>#FRD</b> Len 32Bit, Data	Transmits the content of the file opened for reading, <b>Data</b> , complete with the length, <b>Len</b> .
Number of port modules	<b>#HPI</b> Subscriber16Bit	Information about which port module is connected. <b>Subscriber</b> is bit-coded. Bit0 = Address 0 .. Bit7 = Address 7...
Read Port(Byte)	<b>#HPR</b> Portnr 8Bit, Number 8Bit, Value 8Bit	The port status <b>Value</b> is transmitted. <b>Portnr</b> /port number specifies the port as from which data is being read, <b>number</b> the number of ports to be read.
Read Port(Bit)	<b>#HBR</b> Bitnr 8Bit, Number 8Bit, Value 8Bit	The pin status <b>Value</b> is transmitted. <b>Bit Number</b> specifies the port pin as from which data is read, <b>number</b> the number of pins to be read.
Read analogue input	<b>#HAR</b> Channel 8Bit, Number 8Bit, Value 16Bit	The analogue value, <b>Value</b> , is transmitted. <b>Channel</b> specifies the analogue channel as from which data is read, <b>number</b> the number of channels to be read.
Master RS232 data	<b>#HRR</b> Len 32Bit, Data	Return of the data received via the Master-RS232, <b>Data</b> , with the length <b>Len</b> .



Designation	Command code	Description
Master SPI data	<a href="#">#HSR</a> Len 32Bit, Data	Return of the data received via the Master-SPI , <b>Data</b> , with the length <b>Len</b> .
Master I <sup>2</sup> C data	<a href="#">#HIR</a> Len 32Bit, Data	Return of the data received via the Master-I <sup>2</sup> C, <b>Data</b> , with the length <b>Len</b> .
String file - number	<a href="#">#VFC</a> Number 16Bit	Displays the number, <b>Number</b> , of the strings contained in the string file.
String register - ASCII	<a href="#">#VSA</a> Number 16Bit, StrLen 16Bit, String	Displays the string, <b>String</b> of the string register, with the number, <b>Number</b> and the string length, <b>StrLen</b> , as an ASCII string..
String register in Unicode	<a href="#">#VSU</a> Number 16Bit, StrLen 16Bit, UnicodeString	Displays the string, <b>String</b> of the string register, with the number, <b>Number</b> and the string length, <b>StrLen</b> , as an Unicode-string...
Read register	<a href="#">#VRG</a> Number 16Bit, Type 16Bit, Value 32Bit	Returns the content, <b>Value</b> , of the register <b>number</b> . In this context, <b>Type</b> determines whether the value is an "I" = integer or "F"=Float.
Request touch control button status	<a href="#">#TQS</a> Object-id 16Bit, Status 16Bit	Displays the <b>Status</b> (1=Up; 2=Down) of the touch control switch, <b>Object ID</b> .
Request the status of the active switch of the radio group	<a href="#">#TQR</a> Group-id 16Bit, Object-id 16Bit	Displays the <b>Object ID</b> of the active touch control switch of the radio group, <b>Group ID</b> ..
Display touch code for key-board	<a href="#">#TGK</a> Object-id16Bit, Code16Bit	Displays the <b>Code</b> of the touch control button of the keyboard, <b>Object ID</b> .
Display touch value instrument	<a href="#">#TQI</a> Object-id16Bit, Value16Bit	Displays the <b>Value</b> , of the instrument <b>Object ID</b> .

## EXAMPLES OF COMMANDS

In the following, most of the graphical commands are illustrated by brief examples.

**OPERATION AND ANIMATION**

**Position curve, scale curve**

**Operational path with change of position**

Draw a straight line in order to visualise the operational path

**#GPL** 1, 2, 100,100, 700,200

Insert a circle with a filling

**#GET** 2, 1, 100, 100, 5, 60

Move operatoin via Path 1

**#AOA** 2, 101, 700, 200

Define type of operation and time of operation

**#AOT** 2, 5, 500

For the complete set of commands of the sample image [see p. 131](#).

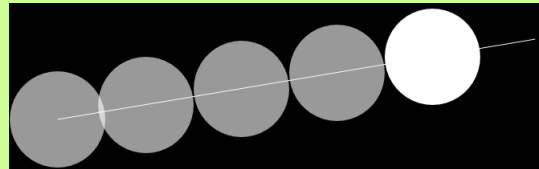

**Elliptical operational path with change of position**

Insert an ellipse polypath in order to visualise the operational path

**#GPP** 1, 2, 400, 80 ?E0, 300, 150, 0, 400, 380 ?E0, 300, 150, 0, 400, 80

Insert a circle with a filling

**#GET** 2, 1, 400, 80, 5, 60

Define ellipse and line operational path. The path corresponds to Object 1

**#APD** 1, 400, 80 ?E0, 300, 150, 0, 400, 380 ?E0, 300, 150, 0, 400, 80

Move operation via Path 1

**#AOA** 2, 151, 1, 0

Define type of operation and time of operation

**#AOT** 2, 1, 400

For the complete set of commands of the sample image [see p. 133](#).

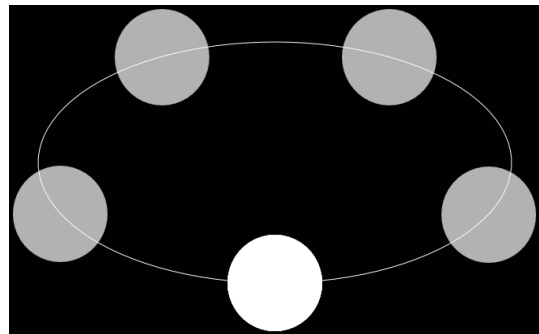

**Changing the size**

Insert a circle with a filling

**#GET** 1, 1, 200, 200, 5, 50

Double the size of the operation

**#AOA** 1, 201, 200, 200

Define type of operation and time of operation

**#AOT** 1, 5, 500

For the complete set of commands of the sample image [see p. 131](#).

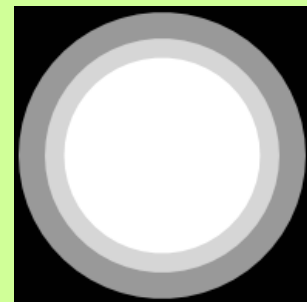

**Changing the size and position**

Insert a polypath ellipse in order to visualise the operational path

**#GPP** 1, 2, 400, 80 ?E0, 300, 150, 0, 400, 380 ?E0, 300, 150, 0, 400, 80

Insert a circle with a filling

**#GET** 2, 1, 400, 80, 5, 60

Define ellipse operational path. The path corresponds to Object 1

**#APD** 1, 400, 80 ?E0, 300, 150, 0, 400, 380 ?E0, 300, 150, 0, 400, 80

Change in size of operational path

**#APD** 2, 100, 100 ?L, 30, 30 ?L, 100, 100

Operational movement and change in size

**#AOA** 2, 151, 1, 0, 251, 2, 0

Define type of operation and time of operation

**#AOT** 2, 1, 400

For the complete set of commands of the sample image [see p. 132](#).

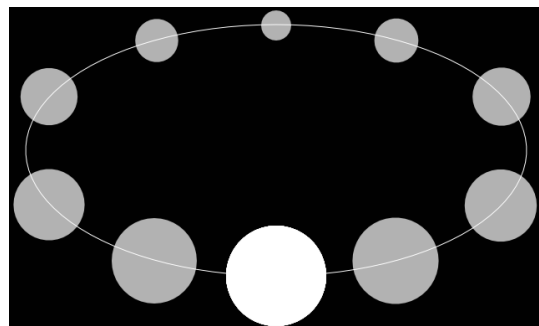

## Rotation Curve, Shear Curve

### Rotation

Define rectangle as being horizontal

**#GRR** 1, 1, 50,100,4, 300,40,5

Operational rotation through 90° anti-clockwise

**#AOA** 1, 301, 90

Define type of operation and time of operation

**#AOT** 1, 4, 500



For the complete set of commands of the sample image [see p. 132](#).

### Changing the rotation and position

Insert an ellipse polypath in order to visualise the operational path

**#GPP** 1, 2, 400, 80 ?E0, 300, 150, 0, 400, 380 ?E0, 300, 150, 0, 400, 80

Insert a circle with a filling

**#GRR** 2, 1, 400, 80, 5, 20,100,2

Define ellipse operational path. The path corresponds to Object 1

**#APD** 1, 400, 80 ?E0, 300, 150, 0, 400, 380 ?E0, 300, 150, 0, 400, 80

Change in size of operational path

**#APD** 2, 100, 100 ?L, 30, 30 ?L, 100, 100

Move operation along the path, revolving

**#AOA** 2, 151, 1, 0, 351,1,0

Define type of operation and time of operation

**#AOT** 2, 1, 400

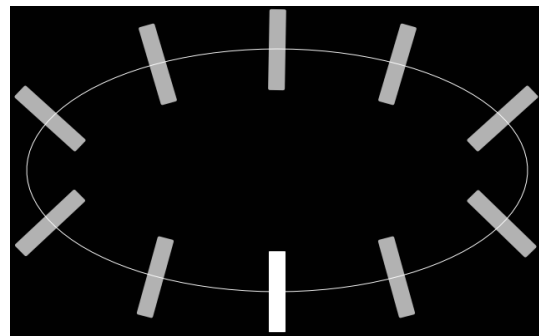

For the complete set of commands of the sample image [see p. 134](#).

### Distort

Define square

**#GRR** 1, 1, 100,100,5, 80,80,5

Operation: Shearing of object by 40° on both axes

**#AOA** 1, 401, 40,40

Define type of operation and time of operation

**#AOT** 1, 4, 500



For the complete set of commands of the sample image [see p. 134](#).

### Opacity curve, colour offset curve

#### Opacity

Define square

#GRR 1, 1, 100,100,5, 80,80,5

Operation: change the alpha channel

#AOA 1, 501, 20

Define type of operation and time of operation

#AOT 1, 4, 500

For the complete set of commands of the sample image [see p. 130](#).



#### Colour transformation

Define square

#GRR 1, 1, 100,100,5, 80,80,5

Colour transformation operation Remove red and green portion

#AOA 1, 501, -100,-100

Define type of operation and time of operation

#AOT 1, 4, 500

For the complete set of commands of the sample image [see p. 130](#).



**BILD / VEKTORGRAFIKEN**

**Bilder / Vektorgrafiken**

**Plazierung eines (Vektor-)Bildes**

Tiger platzieren, Größe proportional skalieren

#PPP 1, "tiger"; 400, 240, 5, 150



**Plazierung einer Animation mit Typänderung**

Erde platzieren, Größe proportional skalieren

#PPP 1, "Erde"; 400, 240, 5, 150

Zyklische Animation in eine Ping-Pong-Animation (pendelnd) ändern

#PPA 1,3

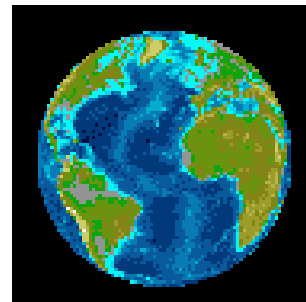

**Video**

**Plazierung eines Videobildes**

Video platzieren, Größe proportional skalieren

#PVP 1, 400, 240, 5, 300



**EIN- UND AUSGÄNGE**

**PWM**

**PWM Ausgang**

PWM Frequenz 1 kHz, 100 µs high, 900 µs low

#HFO 1000,10, 100

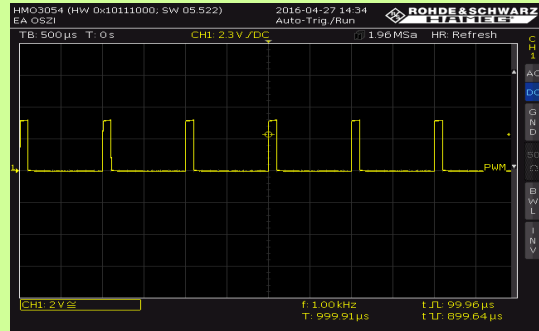

**I/O Port**

**Port Control**

Port 0 abwechselnd als Ein und Ausgang, Port 1, 2 Aus, 6 Eingänge

#HPC 0, \$AA, \$03

Port 0 (Bit 0-7)	Port 1 (Bit 8-15)
<input checked="" type="checkbox"/> <input type="checkbox"/> <input checked="" type="checkbox"/> <input type="checkbox"/> <input checked="" type="checkbox"/> <input type="checkbox"/> <input checked="" type="checkbox"/> <input type="checkbox"/>	<input type="checkbox"/> <input checked="" type="checkbox"/> <input checked="" type="checkbox"/> <input checked="" type="checkbox"/> <input checked="" type="checkbox"/> <input checked="" type="checkbox"/> <input checked="" type="checkbox"/> <input checked="" type="checkbox"/>

**Port Ausgänge**

Port 0 abwechselnd als Ein und Ausgang, Port 1, 2 Aus, 6 Eingänge

#HPC 0, \$AA, \$03

Verfügbare Ausgänge Abwechselnd An und Ausschalten

#HPW 0, \$44, \$A8

Port 0 (Bit 0-7)	Port 1 (Bit 8-15)
<input checked="" type="checkbox"/> <input type="checkbox"/> <input type="checkbox"/> <input type="checkbox"/> <input type="checkbox"/> <input type="checkbox"/> <input type="checkbox"/> <input type="checkbox"/>	<input type="checkbox"/> <input checked="" type="checkbox"/> <input checked="" type="checkbox"/> <input checked="" type="checkbox"/> <input checked="" type="checkbox"/> <input checked="" type="checkbox"/> <input checked="" type="checkbox"/> <input checked="" type="checkbox"/>

**INSTRUMENTS**

**#IBR, IBT, IBA, IGM, IGS, IPP, IVA,**

**Bar graph with rounded corners**

Bar graph with green gradient as a foreground, inclusive of the white frame. Background plain blue.

#IBR 1, 1, 2, 150, 70, 4, 300, 50, 15  
Set bar graph to the value 70.

#IVS 1, 70

For the complete set of commands of the sample image [see p. 136](#).

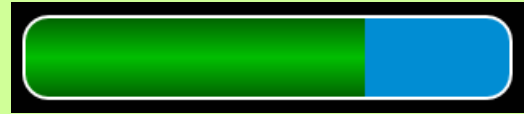

**Triangular bar graph**

Bar graph with green gradient as a foreground, inclusive of the white frame. Background plain blue.  
As an indication, the three possible positions of the point have been highlighted.

#IBT 1, 1, 2, 150, 70, 4, 300, 100  
Set bar graph to the value 70.

#IVS 1, 70

For the complete set of commands of the sample image [see p. 135](#).

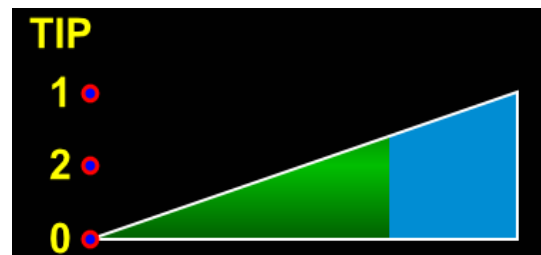

**Arc - bar graph**

Bar graph with green gradient clockwise as a foreground, inclusive of the white frame. Background plain blue.

#IBA 1, 1, 2, 150, 70, 4, 300, 45, 45, 135  
Set bar graph to the value 70.

#IVS 1, 70

For the complete set of commands of the sample image [see p. 137](#).

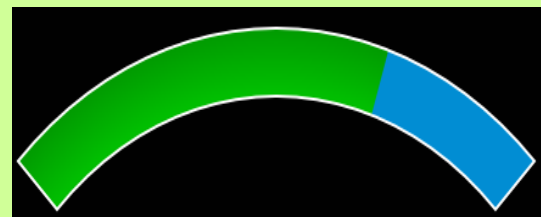

**Object group as a rotational instrument**

Defines Object Group 2 as a rotational instrument.

#IGM 2, 180, -180, -90, 90

For the complete set of commands of the sample image [see p. 137](#).

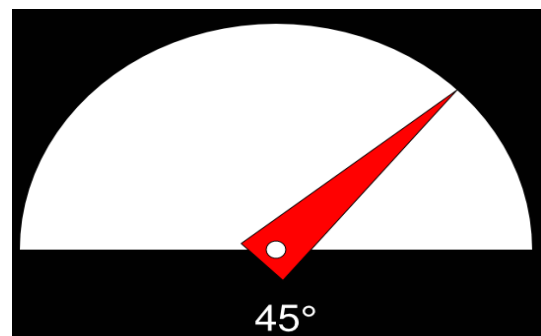



#IBR, IBT, IBA, IGM, IGS, IPP, IVA,

**Object group as a slider**

Defines Object Group 3 as a slider

#IGS 3, 1, 2, 0, 0, 100

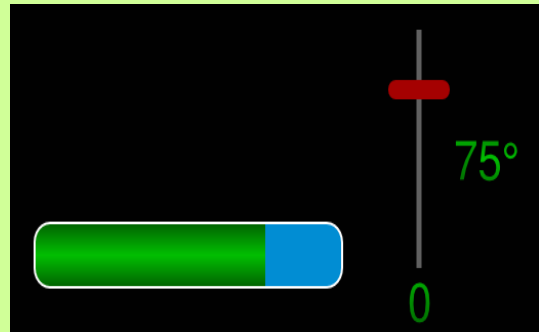

For the complete set of commands of the sample image [see p. 138](#).

**Wattmeter as an instrument**

Place instrument file; original image size, start value =0, end value =500

#IPP 1, "Wattmer"; 400,200,5,0,0,0,500

Set bar graph to 70% (0.7x500)

#IVS 1, 350



For the complete set of commands of the sample image [see p. 136](#).

**Bar graph value update**

Rectangular bar, with start and end value, adjusted to seconds

#IBR 1, 1, 2, 150, 70, 4, 300, 50, 15,0,59

Change bar automatically with the second

#IVA 1,(second())



For the complete set of commands of the sample image [see p. 136](#).

**KEYBOARD**

**#KDB, KDL, KDC, KPK**

**Object group as a keyboard field**

Define Object Group 5 as a keyboard field  
Generating the keyboard field for Keyboard1

**#KDB** 5, 1, "^1234567890ß\8\C"; "\6qwertzuiopü+\D\D"; "\5asdfghjklöä#\N"; "<yxcvbnm,.-"; ""

Generating the keyboard field for Keyboard2

**#KDB** 5, 2, "!"\$%&/()=?\8\C"; "\6QWERTZUIOPÜ\*\D\D"; "\5ASDFGHJKLÖÄ#\N"; ">YXCVBNM;\_"; ""



For the complete set of commands of the sample image [see p. 139](#).

**Change key labelling of the special keys**

Change labelling of the special keys in Object Group 5

**#KDL** 5, 5 "Shift"; 6 "Caps"; 8 "Back"; 12 "Clear"; 13 "Return"



For the complete set of commands of the sample image [see p. 139](#).

**Define button style for keys**

Define button style for normal and special keys of Length 1

**#KDC** 5, 1, 2

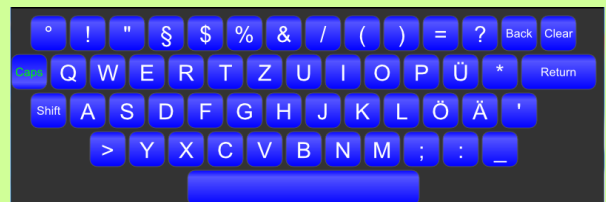

For the complete set of commands of the sample image [see p. 139](#).

**Place object group as a keyboard**

Places Object Group 5 as a keyboard

**#KPK** 5, 0, 0, 7, 800



For the complete set of commands of the sample image [see p. 139](#).

## STRING ZEICHENKETTENBEFEHLE

### #SSP, SFP, SAP

#### Zeichenkette platzieren

Platzierung einer einfachen Zeichenkette

[#SSP](#) 1, 1, 50, 50, 17, "Hello World"



#### Formatierte Zeichenkette platzieren

Platzierung einer formatierten Zeichenkette

[#SFP](#) 1, 1, 50, 50, 17, "Int: %d, Float: %.3f, Hex: 0x%02X"; 3, 3.14, 13



#### Formatierte sich selbst erneuernde Zeichenkette platzieren

Sobald sich der Analogeingang 0 ändert wird diese Zeichenkette neu dargestellt

[#SAP](#) 1, 1, 50, 50, 17, "Analog In 0: %.2f V"; (3.3/4095\*analog(0))



#### Update-Kalkulation ändern

Sobald sich der Analogeingang 0 ändert wird diese Zeichenkette neu dargestellt

[#SAP](#) 1, 1, 50, 50, 17, "Analog In 0: %.2f V"; (3.3/4095\*analog(0))

Ab jetzt wird die Zeichenkette im Sekundentakt erneuert, wobei weiterhin der Analogwert angezeigt wird

[#SAC](#) 1, (second())

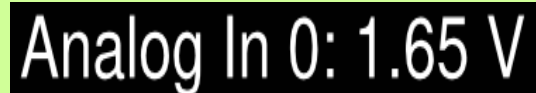

#### Date and Time

Placing a formatted date

[#SDP](#) 1, 1, 50, 50, 17, "%W the %D. %3N %Y, %1h:%m"



For the complete set of commands of the sample image [see p. 140](#).

## EDITBOX

### #SEP, SEK, SEA

#### Platzierung Editbox

Platzierung von drei Editboxen

#SEP 6, 20, 400, 280, 8, 300, 50, 6, 21, -5, -3

#SEP 7, 20, 400, 340, 8, 300, 50, 6, 22, 5, -3

#SEP 8, 20, 400, 400, 8, 300, 50, 6, 23, 5, -3

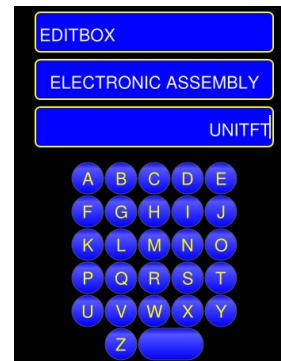

For the complete set of commands of the sample image [see p. 140](#).

#### Zuweisung von drei Editboxen auf eine Tastatur

Editboxen 6-8 der Tastatur 9 zuweisen

#SEK 9, 6-8

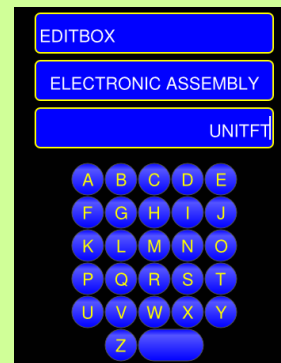

For the complete set of commands of the sample image [see p. 140](#).

#### Aktivierung Editbox

Aktiviert Editbox 8, die oberste der drei Editboxen

#SEA 8



For the complete set of commands of the sample image [see p. 140](#).

STYLE SHEETS

**Farbverlauf und Linienmuster**

**Farbverlauf**  
Erstellung eines Gradientenverlaufs mit 3 Stützpunkten RGB,  
wobei Grün leicht durch den Alphakanal abgedunkelt wird.  
[#CCR](#) 1, 0,\$FF0000,100, 50,\$00FF00,70, 100,\$0000FF,100

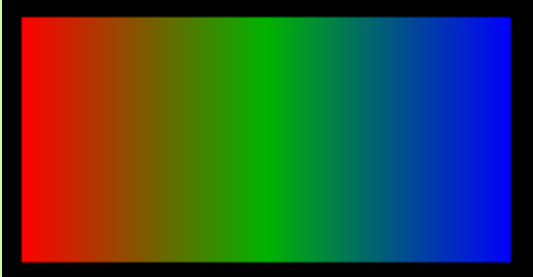

For the complete set of commands of the sample image [see p. 141](#).

**Linienmuster**  
Erstellung eines Linienmusters (Dash pattern),  
[#CDP](#) 1, 0, 20,10, 5,10

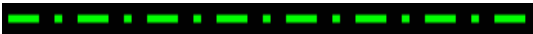

For the complete set of commands of the sample image [see p. 141](#).

## Füllungen

### **Einfarbige Füllung**

Füllfarbe definieren, der Alphakanal ist optional,

[#CFC](#) 1, \$00FF00

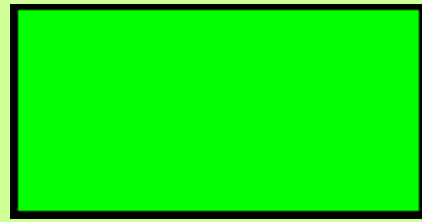

For the complete set of commands of the sample image [see p. 142](#).

### **Lineare Farbverlaufsfüllung**

Gradientenverlauf als linearen Verlauf nutzen - um 45° geneigt

[#CFL](#) 1, 1, 45

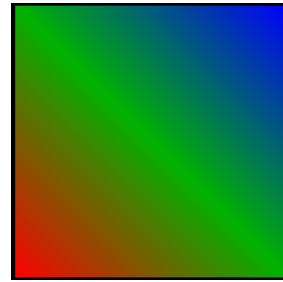

For the complete set of commands of the sample image [see p. 142](#).

### **Radiale Farbverlaufsfüllung**

Gradientenverlauf als radialen Verlauf nutzen. Anker 5 als Fokuspunkt nutzen

[#CFR](#) 1, 1, 5000,5

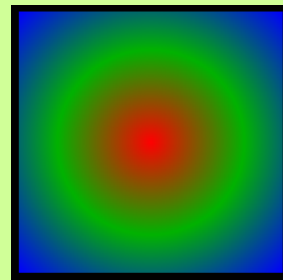

For the complete set of commands of the sample image [see p. 142](#).

### **Konische Farbverlaufsfüllung**

Gradientenverlauf als konischen Verlauf nutzen.

Anker 5 als Fokuspunkt nutzen. Die Drehrichtung ist im Uhrzeigersinn

[#CFK](#) 1, 1, 5000,5

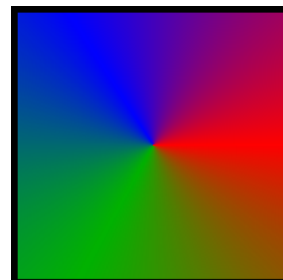

For the complete set of commands of the sample image [see p. 142](#).

## Füllungen

### Musterfüllung

Füllung mit sich selbst wiederholendem Muster

`#CFP 1, "marmor02"`

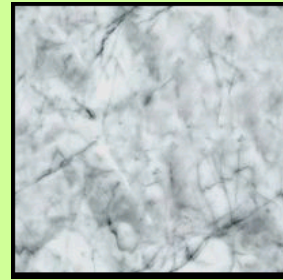

For the complete set of commands of the sample image [see p. 142](#).

## Linienstyle

### Linienfarbe und -dicke

Keine Füllung definieren

`#CFD 1`

grüne Linie mit 5 Pixel dicke

`#CLS 1, $00FF00,100, 5`

Rechteck zeichnen

`#GRR 1,1, 50,50,7,200,100`



For the complete set of commands of the sample image [see p. 143](#).

### Linienverbindung

Linienverbindung mit abgerundeten Ecken (Round = 1)

`#CLE 1, 1`

Linienverbindung mit spitzen Ecken (Miter = 0)

`#CLE 2, 0`



For the complete set of commands of the sample image [see p. 143](#).

## Textstyle

### Textstyle

Erstellung eines Textstyles mit dem internen Font "Sans"

`#CTF 1, <!:Sans.evf>, 60,1,1`

Hello World

For the complete set of commands of the sample image [see p. 143](#).

## Buttonstyle

### Touchbutton als Bild

Zwei Bilder als Touchbuttonstyle definieren

#CBP 1, "Padlock\_closed"; "Padlock\_opend"

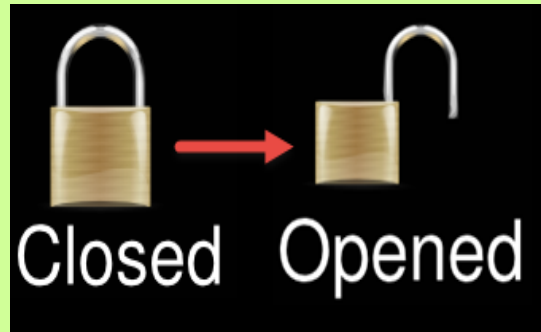

For the complete set of commands of the sample image [see p. 144](#).

### Touchbuttonstyle für geometrische Objekte

Touchbuttonstyle mit 200 Breite, 50 Höhe und Eckenradius 50

#CBD 1, 5,6, 200,50,10



For the complete set of commands of the sample image [see p. 144](#).

### Touchbutton Proportion bei Drücken ändern

Touchbutton soll seine Größe auf 70% im  
gedrückten Zustand ändern

#CBO 1, 0,0, 70



For the complete set of commands of the sample image [see p. 144](#).



## TERMINAL COMMANDS

### Terminal window

#### **(Re-)define terminal window**

Small terminal window with 40 characters and 20 lines

`#YDW 1,30,30,7,40,20`

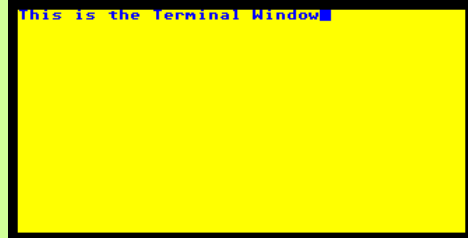

For the complete set of commands of the sample image [see p. 145](#).

#### **Terminal window foreground/background colour**

Small terminal window with 40 characters and 20 lines

Font colour blue, window colour yellow, non-transparent

`#YDC $0000FF,100,$FFFF00,100`

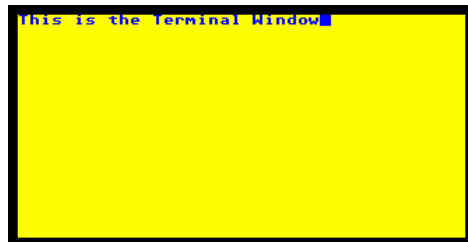

For the complete set of commands of the sample image [see p. 145](#).

TOUCH CONTROL OBJECTS/TOUCH CONTROL FUNCTIONS

**Touch control zones**

**Rectangular touch button**

Set touch control switch to position 400,240.

External dimensions are defined by the button style

#TSR 1, 1, "Normal"; "Pushed"; 400,240



For the complete set of commands of the sample image [see p. 146](#).

**Elliptical touch button**

Set touch control switch to position 400,240.

External dimensions are defined by the button style

#TSE 1, 1, "Normal"; "Pushed"; 400,240



For the complete set of commands of the sample image [see p. 146](#).

**Touch button as an image**

Use two images as a touch button

#TSP 1, 1, "Closed"; "Opened"; 400,240,7



TIME

#WGC

**Object group as a clock**

Define Object Group 10 as a clock

Objects 6, 7 and 8 form the clock hands

#WGC 10, 6, 7, 8



For the complete set of commands of the sample image [see p. 147](#).

**DRAWING/GRAPHIC PRIMITIVES**

**Rounded rectangle with border**

**Rounded rectangle with border**

Rounded rectangle with border, a type of picture frame

[#GRR](#) 1,1,400,240,5,200,100,20,15

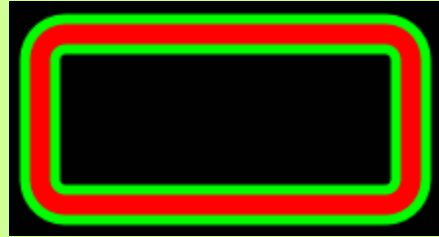

For the complete set of commands of the sample image [see p. 148](#).

**Polyline - Santa Claus house**

Draw a Santa Claus house with the aid of a polypath

[#GPL](#) 1,1,20,20,20,100,70,100,70,20,20,20,70,100,45,130,20,100,70,20



For the complete set of commands of the sample image [see p. 148](#).

**Filled-in polyline - trapezium**

Draw a filled-in trapezium with the aid of a polypath

[#GPF](#) 1,1,20,20,60,80,160,80,120,20

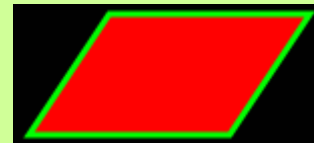

For the complete set of commands of the sample image [see p. 148](#).

**Extend a polyline - Santa Claus house**

Extend the Santa Claus house by the 3 dimensions

[#GPA](#) 1,1,20,20,20,100,70,100,70,20,20,20,70,100,45,130,20,100,70,20

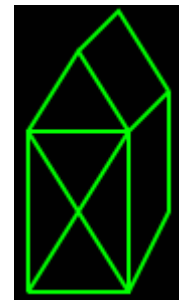

For the complete set of commands of the sample image [see p. 148](#).

## Graphic drawing objects

### Polypath - Draw a car

Draw a car with path segments

**#GPP** 1,1, 50,200, ?v-50, ?h150, ?c0,70,130,0, ?h200, ?c0,70,130,0, ?h90, ?v100, ?h-85, ?l-40,65, ?h-220, ?q-40,0,-145,-75, ?h-130, ?z

Course of the relative polypath:

The line is drawn vertically, 50 pixels downwards from the starting point. A horizontal alignment then follows towards the right. The wheels are drawn between the three horizontal segments using segments of a circle. The wheels are drawn in such a way that their width amounts to 130 pixels. A vertical alignment by 100 pixels upwards follows, as well as a vertical line by 85 pixels to the left. For the rear windscreen, a line segment is used, which sets the end point to 40 pixels to the left and 65 pixels above the last position, and connects it by means of a line. A horizontal line to the left, having a length of 220 pixels, then follows. For the front windscreen, a quadratic Bezier segment is used. A horizontal line to the left with 130 pixels, as well as the end of the path, follows thereafter.

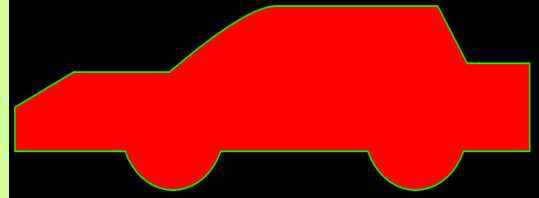

For the complete set of commands of the sample image [see p. 148](#).

### Hexagon

A hexagon rotated through 90°

**#GGP** 1, 1 400,240,5, 100,6,0, 90

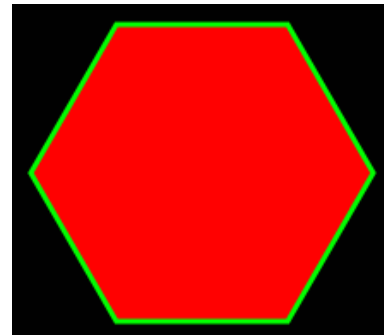

For the complete set of commands of the sample image [see p. 149](#).

### Five-point star

Draw a filled-in star

**#GGS** 1, 1 400,240,5, 100,50, 5



For the complete set of commands of the sample image [see p. 149](#).

**Graphic drawing objects**

**Tyres**

A circle with a hole

#GET 1, 1 400,240,5, 100,100, 30

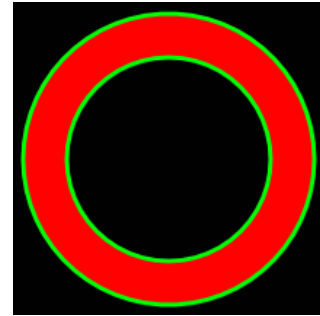

For the complete set of commands of the sample image [see p. 149](#).

**Graphic drawing objects**

**Arc of a circle**

Draw a letter "C" as an arc of a circle

#GEA 1, 1 400,240,5, 100,100, 45,-45, 30



For the complete set of commands of the sample image [see p. 149](#).

**Cut segments of a circle**

Draw two cut segments of a circle

#GES 1, 1, 400, 200, 5, 100, 100, 90, 0

#GES 2, 1, 450, 200, 5, 100, 100, 180, 60

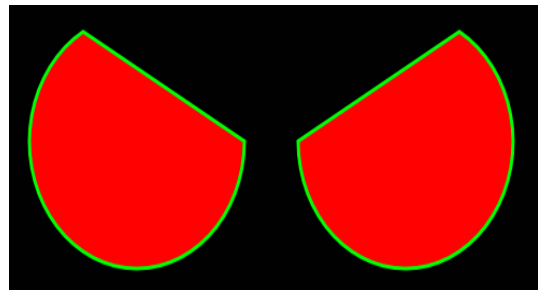

For the complete set of commands of the sample image [see p. 150](#).

**Piece of cake**

Draw a piece of cake

#GEP 1, 1 400,240,5, 100,100, 135,225

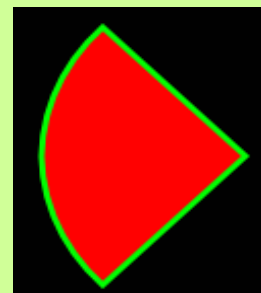

For the complete set of commands of the sample image [see p. 150](#).

## SEGEMENTTYPEN

### Segmente H(orizontal), V(ertikal), L(inear)

#### **Polypfad Horizontal**

Horizontale Linie als Polypfad erzeugen

#GPP 1, 1, 10, 50, ?H 300



For the complete set of commands of the sample image [see p. 151](#).

#### **Polypfad Vertikal**

Vertikale Linie als Polypfad erzeugen

#GPP 1, 1, 50, 50, ?V 150



For the complete set of commands of the sample image [see p. 151](#).

#### **Polypfad Linie**

Linie als Polypfad erzeugen

#GPP 1, 1, 50, 50, ?L 250, 100

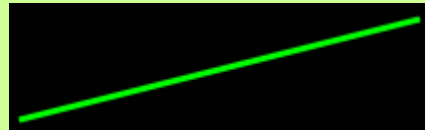

For the complete set of commands of the sample image [see p. 151](#).

**Segmente C(ircle), E(llipse)**

**Polypfad Kreissegment**

Kreissegment gegen den Uhrzeigersinn mit dem Radius 120. Der Radius muss mindestens Abstand/2 betragen

#GPP 1, 5, 200,200,?C0,120,400,200

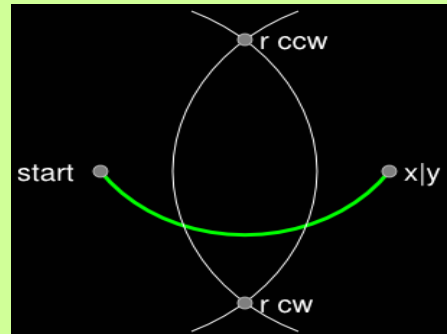

For the complete set of commands of the sample image [see p. 152](#).

**Polypfad Ellipse**

Ellipse durch die beiden Punkte

#GPP 1, 5, 200,300,?E,110,150,0,400,300

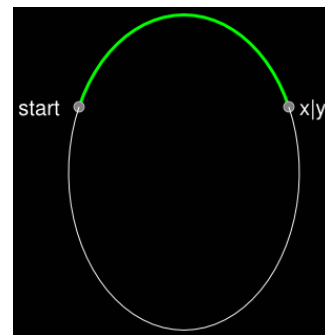

For the complete set of commands of the sample image [see p. 152](#).

**Segmente Q(uadratische Bézier Kurve), R**

**Polypfad quadratische Bézierkurve**

Eine quadratische Bézierkurve platzieren. Der Stützpunkt bestimmt die gezeichnete Kurve

#GPP 1, 5, 200,300,?Q 250, 200,400,300

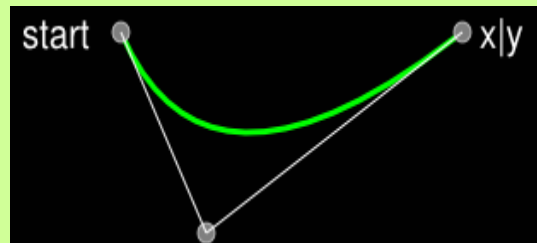

For the complete set of commands of the sample image [see p. 153](#).

**Polypfad quadratische Bézierkurve mit Hilfspunkt**

Eine quadratische Bézierkurve platzieren. Der Stützpunkt wird durch das vorher gezeichnete Segment vorgegeben (Punktspiegelung) Dadurch werden die einzelnen Segmente immer tangential Zusammengefügt und bilden eine geglätteten Übergang.

#GPP 1, 5, 200,300,?Q 210,200,300,300, ?R 460,300

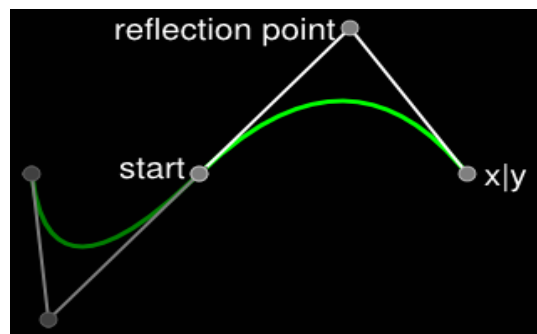

For the complete set of commands of the sample image [see p. 154](#).



**Segmente T, S(pline)**

**Polypfad Spline**

Spline zeichnen

#GPP 1, 5, 100,50,?S150,100,250,100,300,50

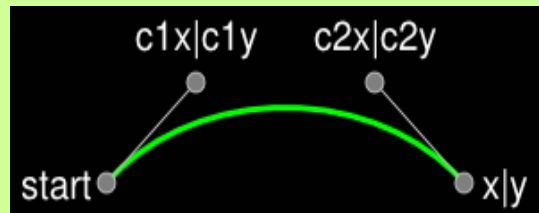

For the complete set of commands of the sample image [see p. 155.](#)

**Polypfad geglättete kubische Bézierkurve**

Die geglättete kubische Bézierkurve übernimmt von dem vorhergegangenen Pfad den letzten Stützpunkt und spiegelt diesen am Startpunkt der eigenen Kurve. Es ergibt sich so ein tangentialer also glatter Übergang zwischen beiden Segmenten.

#GPP 1, 5, 200,200, ?s-10,80,60,40,80,0, ?t70,-35,100,0

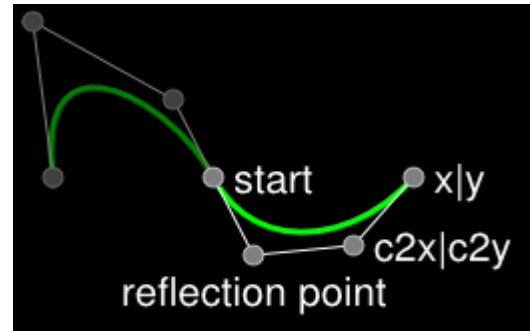

For the complete set of commands of the sample image [see p. 156.](#)

**Segmente Z, M**

**Polypfad schließen**

Nach Zeichnen der Ellipse wird der Polypfad geschlossen

#GPP 1, 5, 200,200, ?e1,100,70,0,200,0, ?Z

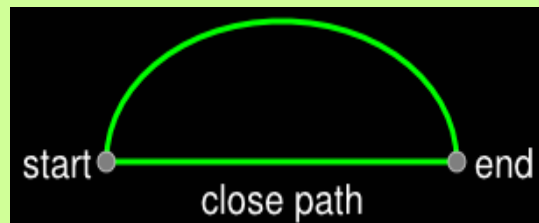

For the complete set of commands of the sample image [see p. 157.](#)

**Polypfad Sprung**

Platzierung eines Kreises in einem Rechteck, als ein Polypfadobjekt. Vor allem mit Füllung interessant

#GPP 1, 5, 200,200, ?h100, ?v100, ?h-100, ?Z, ?M250, 210, ?c1,40,0,80, ?c1,40,0,-80

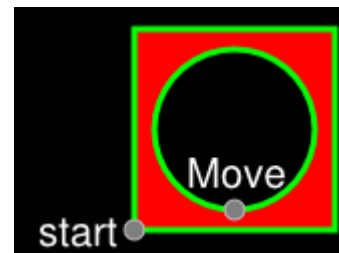

For the complete set of commands of the sample image [see p. 157.](#)

**COMMANDS FOR THE EXAMPLES**

The complete commands which are necessary for the creation of the sample images are shown below.

**OPERATION AND ANIMATION**

### Opacity curve, colour offset curve

**Opacity**

Define square

[#GRR](#) 1, 1, 100,100,5, 80,80,5

Operation: change the alpha channel

[#AOA](#) 1, 501, 20

Define type of operation and time of operation

[#AOT](#) 1, 4, 500

Define white filling

[#CFC](#) 4, \$FFFFFF, 60

Create rectangles

[#GRR](#) 2, 4, 200,100,5, 80,80,5

[#GRR](#) 3, 1, 300,100,5, 80,80,5



**Colour transformation**

[#CFC](#) 4, \$7F7FFF, 60

Define square

[#GRR](#) 1, 1, 100,100,5, 80,80,5

Colour transformation operation Remove red and green portion

[#AOA](#) 1, 501, -100,-100

Define type of operation and time of operation

[#AOT](#) 1, 4, 500

Define remaining squares

[#GRR](#) 2, 4, 200,100,5, 80,80,5

[#GRR](#) 3, 1, 300,100,5, 80,80,5



## Position Curve, Scale Curve

### Operation path with change of position

Draw a straight line in order to visualise the operation path

```
#GPL 1, 2, 100, 100, 700, 200
      Insert a circle with a filling
#GET 2, 1, 100, 100, 5, 60
      Move operation via Path 1
#AOA 2, 101, 700, 200
      Define type of operation and time of operation
#AOT 2, 5, 500
      Set integer register
#VRI 0, 3, 1, 10
      Define white filling
#CFC 4, $FFFFFF, 60
      Define circles with filling, as well as their type of operation and time of
      operation
#GET R0, 4, 100, 100, 5, 60
#AOA R0, 101, 700, 200
#AOT (R0++), 5, 600, 100
#GET R0, 4, 100, 100, 5, 60
#AOA R0, 101, 700, 200
#AOT (R0++), 5, 700, 200
#GET R0, 4, 100, 100, 5, 60
#AOA R0, 101, 700, 200
#AOT (R0++), 5, 800, 300
#GET R0, 4, 100, 100, 5, 60
#AOA R0, 101, 700, 200
#AOT (R0++), 5, 900, 400
```

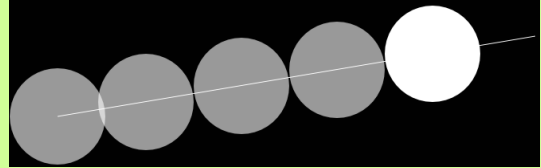

### Changing the size

Insert a circle with a filling

```
#GET 1, 1, 200, 200, 5, 50
      Double the size of the operation
#AOA 1, 201, 200, 200
      Define type of operation and time of operation
#AOT 1, 5, 500, 0
      Define white filling
#CFC 4, $FFFFFF, 60
      Set integer register
#VRI 0, 3, 500, 1, 300
      Generate circles and define their type of operation, as well as time of
      operation
#GET R0, 4, 200, 200, 5, 50
#AOA R0, 201, 200, 200
#AOT (R0++), 5, (R1+R2*R3), (R2++*R3)
#GET R0, 4, 200, 200, 5, 50
#AOA R0, 201, 200, 200
#AOT (R0++), 5, (R1+R2*R3), (R2++*R3)
#GET R0, 4, 200, 200, 5, 50
#AOA R0, 201, 200, 200
#AOT (R0++), 5, (R1+R2*R3), (R2++*R3)
#GET R0, 4, 200, 200, 5, 50
#AOA R0, 201, 200, 200
#AOT (R0++), 5, (R1+R2*R3), (R2++*R3)
```

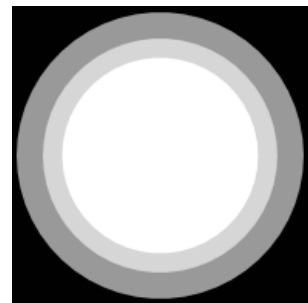

## Position Curve, Scale Curve

### Changing the size and position

Add an ellipse polypath in order to visualise the operation path

**#GPP** 1, 2, 400, 80 ?E0, 300, 150, 0, 400, 380 ?E0, 300, 150, 0, 400, 80

Insert a circle with a filling

**#GET** 2, 1, 400, 80, 5, 60

Define operational path of ellipse The path corresponds to Object 1

**#APD** 1, 400, 80 ?E0, 300, 150, 0, 400, 380 ?E0, 300, 150, 0, 400, 80

Operation path: Change size

**#APD** 2, 100, 100 ?L, 30, 30 ?L, 100, 100

Operation: Moving and changing the size

**#AOA** 2, 151, 1, 0, 251, 2, 0

Define type of operation and time of operation

**#AOT** 2, 1, 400

Set integer register

**#VRI** 0, 3, 1, 10

Define white filling

**#CFC** 4, \$FFFFFF, 70

Set macro file mark

**#MFM**

Create dots/circles

**#GET** R0, 4, 400, 80, 5, 60

Operation: Moving and changing the size

**#AOA** R0, 151, 1, (R1\*R2), 251, 2, (R1++\*R2)

Define type of operation and time of operation

**#AOT** R0, 1, 400

Jump back to the macro file mark

**#MFJ** (R0++<20)

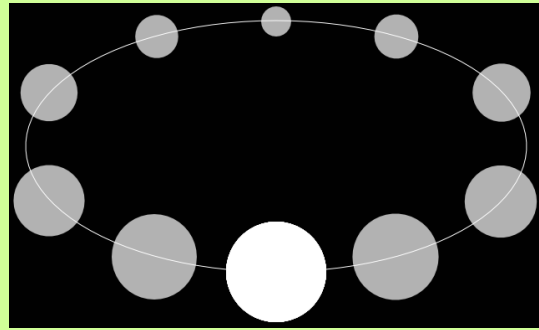

### Rotation

Define rectangle as being horizontal

**#GRR** 1, 1, 50, 100, 4, 300, 40, 5

Operation: Rotate by 90° anti-clockwise.

**#AOA** 1, 301, 90

Define type of operation and time of operation

**#AOT** 1, 4, 500

Set integer register

**#VRI** 0, 2, 1, 100

Define white filling

**#CFC** 4, \$FFFFFF, 70

Set macro file mark

**#MFM**

Create rectangles

**#GRR** R0, 4, 50, 100, 4, 300, 40, 5

Operation: Rotate by 90° anti-clockwise.

**#AOA** R0, 301, 90

Define type of operation and time of operation

**#AOT** R0, 1, 400

Jump back to the macro file mark

**#MFJ** (R0++<20)



**Position Curve, Scale Curve**

***Elliptical operation path with change of position***

Insert an ellipse polypath in order to visualise the operation path

**#GPP** 1, 2, 400, 80 ?E0, 300, 150, 0, 400, 380 ?E0, 300, 150, 0, 400, 80

Insert a circle with a filling

**#GET** 2, 1, 400, 80, 5, 60

Define ellipse and line operation path. The path corresponds to Object 1

**#APD** 1, 400, 80 ?E0, 300, 150, 0, 400, 380 ?E0, 300, 150, 0, 400, 80

Operation: Move object via Path 1

**#AOA** 2, 151, 1, 0

Define type of operation and time of operation

**#AOT** 2, 1, 400

Define white filling

**#CFC** 4, \$FFFFFF, 70

Set integer register

**#VRI** 0, 3, 1, 20

Define circles with type of operation and time of operation

**#GET** R0, 4, 400, 80, 5, 60

**#AOA** R0, 151, 1, (R1++\*R2)

**#AOT** (R0++), 1, 100

**#GET** R0, 4, 400, 80, 5, 60

**#AOA** R0, 151, 1, (R1++\*R2)

**#AOT** (R0++), 1, 100

**#GET** R0, 4, 400, 80, 5, 60

**#AOA** R0, 151, 1, (R1++\*R2)

**#AOT** (R0++), 1, 100

**#GET** R0, 4, 400, 80, 5, 60

**#AOA** R0, 151, 1, (R1++\*R2)

**#AOT** (R0++), 1, 100

**#GET** R0, 4, 400, 80, 5, 60

**#AOA** R0, 151, 1, (R1++\*R2)

**#AOT** (R0++), 1, 100

**#GET** R0, 4, 400, 80, 5, 60

**#AOA** R0, 151, 1, (R1++\*R2)

**#AOT** (R0++), 1, 100

**#GET** R0, 4, 400, 80, 5, 60

**#AOA** R0, 151, 1, (R1++\*R2)

**#AOT** (R0++), 1, 100

**#GET** R0, 4, 400, 80, 5, 60

**#AOA** R0, 151, 1, (R1++\*R2)

**#AOT** (R0++), 1, 100

**#GET** R0, 4, 400, 80, 5, 60

**#AOA** R0, 151, 1, (R1++\*R2)

**#AOT** (R0++), 1, 100

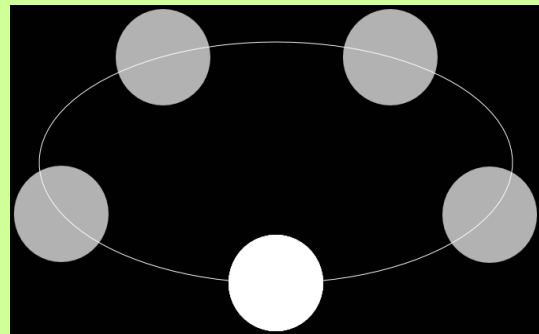

## Position Curve, Scale Curve

### Changing the rotation and position

Insert an ellipse polypath in order to visualise the operation path

**#GPP** 1, 2, 400, 80 ?E0, 300, 150, 0, 400, 380 ?E0, 300, 150, 0, 400, 80

Insert a circle with a filling

**#GRR** 2, 1, 400, 80, 5, 20, 100, 2

Define operational path of ellipse. The path corresponds to Object 1

**#APD** 1, 400, 80 ?E0, 300, 150, 0, 400, 380 ?E0, 300, 150, 0, 400, 80

Move operation along the path, revolving

**#AOA** 2, 151, 1, 0, 351, 1, 0

Define type of operation and time of operation

**#AOT** 2, 1, 400

Set integer register

**#VRI** 0, 3, 1, 10

Define white filling

**#CFC** 4, \$FFFFFF, 70

Set macro file marker

**#MFM**

Create rectangles

**#GRR** R0, 4, 400, 80, 5, 20, 100, 2

Move operation along the path, revolving

**#AOA** R0, 151, 1, (R1\*R2), 351, 2, (R1++\*R2)

Define type of operation and time of operation

**#AOT** R0, 1, 400

Jump back to the macro file marker

**#MFJ** (R0++<20)

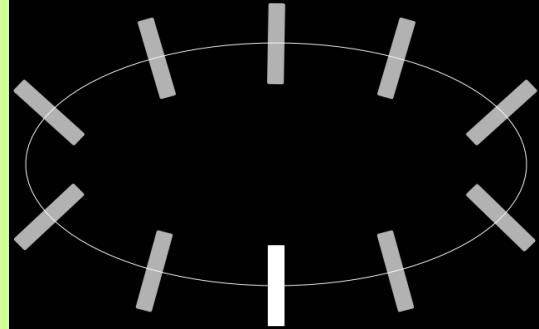

### Distort

Define square

**#GRR** 1, 1, 100, 100, 5, 80, 80, 5

Shearing operation 40° on both axes

**#AOA** 1, 401, 40, 40

Define type of operation and time of operation

**#AOT** 1, 4, 500

Set integer register

**#VRI** 0, 2, 1, 200

Define white filling

**#CFC** 4, \$FFFFFF, 70

Set macro file marker

**#MFM**

Create rectangles

**#GRR** R0, 4, 100, 100, 5, 80, 80, 5

Shearing operation 40° on both axes

**#AOA** R0, 401, 40, 40

Define type of operation and time of operation

**#AOT** R0, 4, (500+R1\*R2), (R1++\*R2)

Jump back to the macro file marker

**#MFJ** (R0++<3)



**INSTRUMENTS**

**#IBT, IBR, IVA, IPP, IBA, IGM, IGS**

```

Triangular bar graph
  Define green colour gradient
#CCR 1, 0, $005f00, 100, 50, $00Bf00, 100, 100, $005f00, 100
  Refrain from defining an outline
#CLD 1
  Define monochrome blue filling
#CFC 2, $008dd3, 100
  Define line style for outline
#CLS 2, $ffffff, 100, 2
  Define colour gradient as linear with 90° torsion
#CFL 1, 1, 90,
  Bar graph with green gradient as a foreground. Background plain blue.
  As an indication, the three possible positions of the point have been high-
  lighted
#IBT 1, 1, 2, 150, 70, 4, 300, 100
  Set bar graph to the value 70.
#IVS 1, 70
  Define line style for points
#CLS 5,$FF0000,100,3
  Define blue filling for points
#CFC 5,$0000FF,100
  Define yellow filling for font
#CFC 6,$FFFF00,100
  Refrain from defining an outline for font
#CLD 6
  Define text style
#CTF 2,</Projekt/Font/Arialbd.evf>,40,1,6
  Set integer register
#VRI 0,1
  String Register setzen
#VSS 1,"1"
  Set string register
#VSS 4,"2"
  Set string register
#VSS 7,"0"
  Set marker for macro file
#MFM
  Create points
#GET (10+R0),5,(objX(1,R0)),(objY(1,R0)),5,5
  Generate numbering
#SSP (100+R0),2,(objX(1,R0)-15),(objY(1,R0)),6,T0
  Set integer register
#VRI 0, (R0+3)
  Command serves to jump to the marker of the macrofile again
#MFJ (R0<9)
  Set numbering
#SSP (100+R0),2,(objX(1,1)),(objY(1,1)+20),9,"TIP"
  
```

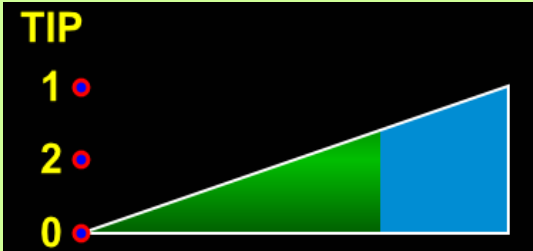

#IBT, IBR, IVA, IPP, IBA, IGM, IGS

**Bar graph with rounded corners**

Define green colour gradient

#CCR 1, 0, \$005f00, 100, 50, \$00Bf00, 100, 100, \$005f00, 100

Refrain from defining an outline

#CLD 1

Define monochrome blue filling

#CFC 2, \$008dd3, 100

Define line style for outline

#CLS 2, \$ffffff, 100, 2

Define colour gradient as linear with 90° torsion

#CFL 1, 1, 90,

Rectangular bar, with start and end value, adjusted to seconds

#IBR 1, 1, 2, 150, 70, 4, 300, 50, 15

Change bar automatically with the second

#IVS 1,70



**Bar graph value update**

Define green colour gradient

#CCR 1, 0, \$005f00, 100, 50, \$00Bf00, 100, 100, \$005f00, 100

Refrain from defining an outline

#CLD 1

Define monochrome blue filling

#CFC 2, \$008dd3, 100

Define line style for outline

#CLS 2, \$ffffff, 100, 2

Define colour gradient as linear with 90° torsion

#CFL 1, 1, 90,

Rectangular bar, with start and end value, adjusted to seconds

#IBR 1, 1, 2, 150, 70, 4, 300, 50, 15,0,59

Change bar automatically with the second

#IVA 1,(second())

Define monochrome white filling for label

#CFC 3, \$FFFFFF,100

Refrain from defining an outline for the font

#CLD 3

Change text style

#CTC 1,3

Place the calculated string in the centre of the object

#SAP 2,1, (objX(1,5)), (objY(1,5)),5, "%d"; (second())



**Wattmeter as an instrument**

Specify project path absolutely

#XPS </Projekt>

Place instrument file; original image size, start value =0, end value =500

#IPP 1, "Wattmeter"; 400,200,5,0,0,0,500

Set bar graph to 70% (0.7x500)

#IVS 1, 350





#IBT, IBR, IVA, IPP, IBA, IGM, IGS

**Arc - bar graph**

Define green colour gradient

#CCR 1, 60, \$005f00, 100, 70, \$00Bf00, 100, 100, \$005f00, 100

Refrain from defining an outline

#CLD 1

Define monochrome blue filling

#CFC 2, \$008dd3, 100

Define line style for outline

#CLS 2, \$ffffff, 100, 2

Define colour gradient as being radial

#CFR 1, 1

Bar graph with green gradient clockwise as a foreground. Background plain blue.

#IBA 1, 1, 2, 150, 70, 4, 300, 45, 45, 135

Set bar graph to the value 70.

#IVS 1, 70

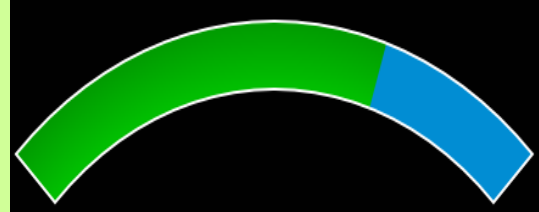

**Object group as a rotational instrument**

Define line style and filling of hands

#CLS 2, \$000000

#CFC 2, \$FF0000

Define line style and filling of point and disc

#CLS 3, \$000000

#CFC 3, \$FFFFFF

Generate disk and hands

#GES 1, 3, 300, 116, 8, 270, 270, 0, 180

#GPF 2, 2, 0, 0, 30, 280, 60, 0

Turn hands, set and place free anchor

#ORA 90, 2

#OAO 30, 20, 2

#OPA 300, 116, 2

Generate white point

#GET 3, 3, 270, 116, 5, 10

Generate group and define it as a rotational instrument

#OGA 5, 1, 2, 3, 4

#IGM 5, 2, 180, -180, -90, 90

Assign touch function

#TID 1, 5

Place calculated string

#SAP 4, 1, 310, 10, 9, "%d°"; (objIV(5))

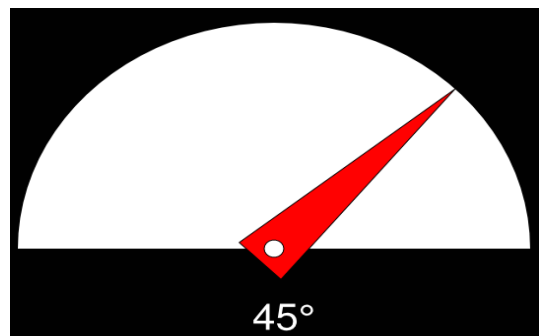

#IBT, IBR, IVA, IPP, IBA, IGM, IGS

**Object group as a slider**

```

Define green colour gradient
#CCR 1, 0, $005f00, 100, 50, $00Bf00, 100, 100, $005f00, 100
Refrain from defining a line style and colour gradient distorted by 90°
#CLD 1
#CFL 1, 1, 90
Define blue filling and white line style for bar graph
#CFC 2, $008dd3, 100
#CLS 2, $ffffff, 100, 2
Define line style for slider path
#CLS 3, $606060, 100, 5
Refrain from defining a line style and red filling for slider
#CLD 4
#CFC 4, $A50000, 100
Place slider with path line
#GPL 1, 3, 425, 60, 425, 245
#GRR 2, 4, 425, 60, 5, 60, 15, 15, 0
Generate group and define it as a slider.
#OGA 3, 1, 2
#IGS 3, 1, 2, 0, 0, 100
Place bar graph
#IBR 4, 1, 2, 50, 70, 4, 300, 50, 15
Assign touch function
#TID 1, 3
Place calculated and fixed string
#SAP 5, 1, 490, 145, 5, "%d°"; (objIV(3))
#SSP 6, 1, 425, 35, 5, "0"
Automatic change in value in the bar graph
#IVA 4, (objIV(3))

```

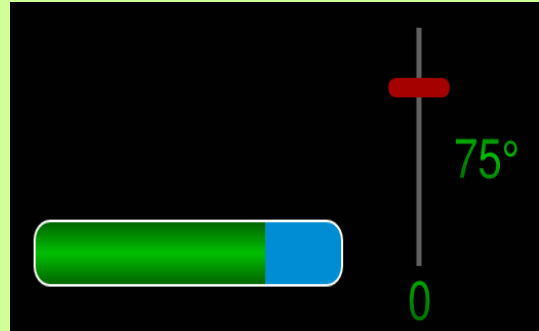

**KEYBOARD**

**#KDB, KDL, KDC, KPK**

**Place object group as a keyboard**

Define line styles, colour gradient and fillings for keys

**#CLD** 11  
**#CFC** 11, \$FFFFFF, 100  
**#CLD** 12  
**#CFC** 12, \$00FF00, 100  
**#CCR** 1, 0, \$0000FF, 100, 80, \$5555FF, 100, 100, \$0000FF, 100  
**#CFL** 15, 1, 90  
**#CLS** 15, \$555555, 100, 1  
**#CFL** 16, 1, 270  
**#CLS** 16, \$555555, 100, 1

Define text styles

**#CTF** 11, <l:Sans.evf>;34, 1, 11  
**#CTF** 12, <l:Sans.evf>;34, 1, 12  
**#CTF** 13, <l:Sans.evf>;18, 1, 11  
**#CTF** 14, <l:Sans.evf>;18, 1, 12

Define text styles for touch buttons

**#CBT** 1, 11, 12, 0, -5  
**#CBT** 2, 13, 14, 0, -2

Define drawing style and change in proportion of the touch button

**#CBD** 1, 15, 16, 100, 50, 10  
**#CBD** 2, 15, 16, 100, 50, 10  
**#CBO** 1, 0, 0, 140  
**#CBO** 2, 0, 0, 100

Define keyboard style

**#KDC** 5, 5, 1, 2

Define keyboard fields

**#KDB** 5, 1, "^1234567890ß\8\C"; "\6qwertzuiopü+|\D\D"; "\5asdfghjklöä#\N"; "<yxcvbnm,-.;" " "  
**#KDB** 5, 2, "!"\$%&/()=?\8\C"; "\6QWERTZUIOPÜ\*\D\D"; "\5ASDFGHJKLÖÄ#\N"; ">YXCVBNM;:\_;" " "

Change labelling of the special keys

**#KDL** 5, 5 "Shift"; 6 "Caps"; 8 "Back"; 12 "Clear"; 13 "Return"

Place keyboard

**#KPK** 5, 0, 0, 7, 800

Fill in frames of the object group/keyboard

**#CLD** 42  
**#CFC** 42, \$FFFFFF, 20  
**#OFP** 42, 10, 10, 5

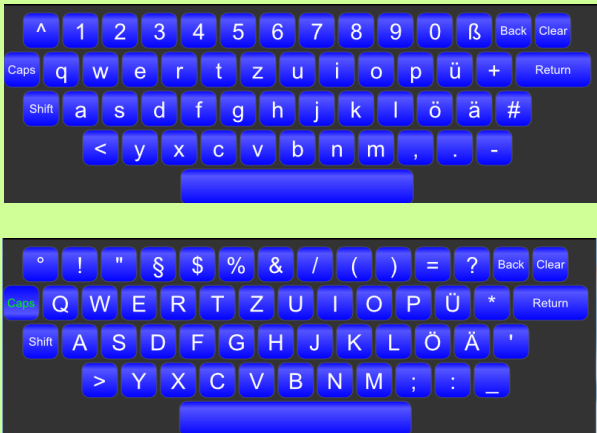

## CHARACTER STRING COMMANDS IN A STRING

### #SDP, SEP, SEK, SEA

#### Date and time

Placing a formatted date

**#SDP** 1, 1, 50, 50, 17, "%W the %D. %3N %Y, %1h:%m"

Changing the formatted date

**#SDC** 1, (datetime(11, 37, 0, 21, 4, 2016))

Thursday the 21. Apr 2016, 11:37

#### Edit box in combination with a keyboard

Define text style for the keyboard

**#CLD** 1

**#CFC** 1, \$FFFF00, 100

**#CTF** 1, <l:Sans.evf>;30, 1 11

Define filling for the keyboard for the pressed-down and not pressed down state

**#CCR** 1, 0, \$0000FF, 100, 80, \$5555FF, 100, 100, \$0000FF, 100

**#CFL** 3, 1, 90

**#CLS** 3, \$555555, 100, 1

**#CFL** 4, 1, 270

**#CLS** 4, \$555555, 100, 1

Define touch button style

**#CBT** 2, 1, 1, 0, 0

**#CBD** 2, 3, 4, 100, 50, 25

**#CBO** 2, 0, 0, 150

Define and place keyboard

**#KDC** 9, 2, 2

**#KDB** 9, 1, "ABCDE";"FGHIJ";"KLMNO";"PQRST";"UVWXY";"Z "

**#KPK** 9, 400, 10, 8, 0, 250

Define border, filling and text style of the edit box

**#CLS** 20, \$FFFF00, 100, 2

**#CFC** 20, \$0000FF, 100

**#CLD** 21,

**#CFC** 21, \$FFFFFF, 100

**#CTF** 21, <l:Sans.evf>;30, 2, 21

**#CTF** 22, <l:Sans.evf>;30, 1, 21

**#CTF** 23, <l:Sans.evf>;30, 0, 21

Place edit boxes

**#SEP** 6, 20, 400, 280, 8, 300, 50, 6, 21, -5, -3

**#SEP** 7, 20, 400, 340, 8, 300, 50, 6, 22, 0, -3

**#SEP** 8, 20, 400, 400, 8, 300, 50, 6, 23, 5, -3

Combine edit boxes and keyboard in one group

**#OGA** 91, 6-9

Allocate edit boxes to the keyboard and enable Edit Box 8

**#SEK** 9, 6-8

**#SEA** 8

Allocate touch function for selecting the edit boxes by touch control

**#TID** 1, 6-8

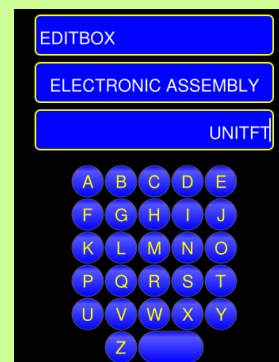

STYLE SHEETS

**Colour gradient and dash pattern(s)**

**Colour gradient**  
Define colour gradient  
**#CCR** 1, 0,\$FF0000,100, 50,\$00FF00,70, 100,\$0000FF,100  
Define colour gradient as being linear  
**#CFL** 1, 1,  
Refrain from defining any line style  
**#CLD** 1  
Create square  
**#GRR** 1,1, 50,50,7,200,100



**Dash pattern(s)**  
Define a dash pattern  
**#CDP** 1, 0, 20,10, 5,10  
Define line style  
**#CLS** 1, \$00FF00,100, 5,0 1  
Refrain from defining a filling  
**#CFD** 1  
Draw a polyline  
**#GPL** 1,1, 50,50,400,50



**Fillings**

**Monochrome filling**

Define a background colour, wherein the alpha channel is optional

**#CFC** 1, \$00FF00

Refrain from defining any line style

**#CLD** 1

Create square

**#GRR** 1,1, 50,50,7,200,100

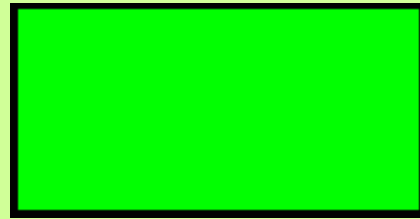

**Linear colour gradient filling**

Define colour gradient

**#CCR** 1, 0,\$FF0000,100, 50,\$00FF00,70, 100,\$0000FF,100

Define colour gradient as being linear and inclined at an angle of 45°

**#CFL** 1, 1, 45

Refrain from defining any line style

**#CLD** 1

Create square

**#GRR** 1,1, 50,50,7,200,200

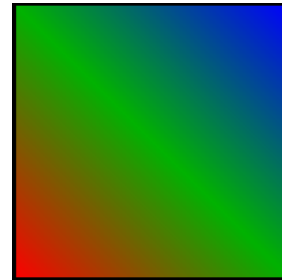

**Radial colour gradient filling**

Define colour gradient

**#CCR** 1, 0,\$FF0000,100, 50,\$00FF00,70, 100,\$0000FF,100

Define colour gradient as being radial

**#CFR** 1, 1, 5000,5

Refrain from defining any line style

**#CLD** 1

Create square

**#GRR** 1,1, 50,50,7,200,200

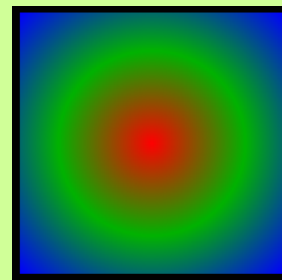

**Conical colour gradient filling**

Define colour gradient

**#CCR** 1, 0,\$FF0000,100, 33,\$00FF00,70, 66,\$0000FF,100, 100, \$FF0000,100

Define colour gradient as being conical

**#CFK** 1, 1, 5000,5

Refrain from defining any line style

**#CLD** 1

Create square

**#GRR** 1,1, 50,50,7,200,200

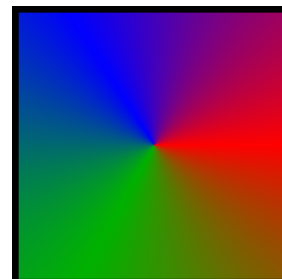

**Pattern filling**

Filling with a recurrent pattern

**#CFP** 1, "marmor02"

Refrain from defining any line style

**#CLD** 1

Create square

**#GRR** 1,1, 50,50,7,200,200



## Linen style

### Line colour and thickness

Green line with a thickness of 5 pixels

`#CLS 1, $00FF00, 100, 5`



### Line joint style

Refrain from defining any line style

`#CLD 1`

Define filling font

`#CFC 1, $FFFFFF, 100`

Define text style

`#CTF 1, <I:Sans.evf>, 58, 0, 1, 0, 1, 0`

Refrain from defining an outline

`#CFD 4`

Define green line style as being angular

`#CLS 4 $00FF00, 100 10, 0`

Refrain from defining an outline

`#CFD 5`

Define green line style as being round

`#CLS 5 $00FF00, 100 10, 1`

Set integer register

`#VRI 0, 50, 50, 20, 50`

Draw a polypath and place string

`#GPL 1, 4, R0, R3, (R0+R1), (R3+R2)rd, R0, (R3+2*R2)`

`#SSP 2, 1, (R0+R1+20), (R3+R2), 4, "Miter"`

Set integer register

`#VRI 3, (R3+3*R2)`

Draw a polypath and place string

`#GPL 3, 5, R0, R3, (R0+R1), (R3+R2), R0, (R3+2*R2)`

`#SSP 4, 1, (R0+R1+20), (R3+R2), 4, "Round"`



## Text style

### Text style

Creating a text style with the internal font "Sans"

`#CTF 1, <I:Sans.evf>, 60, 1, 1`

Place string

`#SSP 1, 1, 200, 50, 7, "Hello World"`

Hello World

## Button style

### Touch button as an image

Define two images as a touch button

**#CBP** 1, "Padlock\_closed"; "Padlock\_opend"

Define text style for touch button

**#CBT** 1, 1, 1, -10, -70

Define images for touch button

**#TSP** 1, 1, "Closed"; "Opened"; 400, 240, 7

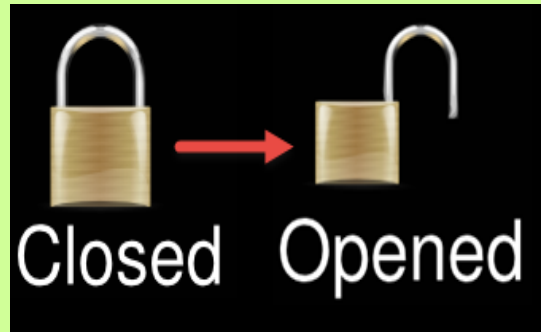

### Change touch button proportion upon pressing it

Change text orientation

**#CTA** 1, 1

Generate colour gradients for touch button

**#CCR** 5, 0, \$00007F, 100, 50, \$0000FF, 100, 100, \$00007F, 100

**#CCR** 6, 0, \$7F7F00, 100, 50, \$FFFF00, 100, 100, \$7F7F00, 100

Create line styles for touch button

**#CLS** 5, \$FFFFFF, 100, 1

**#CLS** 6, \$FFFFFF, 100, 1

Rotate colour gradients by 90°

**#CFL** 5, 5, 90

**#CFL** 6, 6, 90

Define touch button style

**#CBD** 1, 5, 6, 200, 50, 10

Define text style for touch button

**#CBT** 1, 1, 1

Change proportion in the pressed state

**#CBO** 1, 0, 0, 70

Define squarish touch button

**#TSR** 1, 1, "Normal"; "Pushed"; 400, 240, 5





## TERMINAL COMMANDS

### Terminal window

#### **(Re-)define terminal window**

Font colour blue, window colour yellow, non-transparent

**#YDC** \$0000FF,100,\$FFFF00,100



Small terminal window with 40 characters and 20 lines

**#YDW** 1,30,30,7,40,20



This is the Terminal Window

**TOUCH CONTROL OBJECTS/TOUCH CONTROL FUNCTIONS**

Touch control zones	
<b>Rectangular touch button</b>	
	Change text orientation
<a href="#">#CTA</a>	1,1
	Define touch button colour gradients for normal and pressed down states
<a href="#">#CCR</a>	5, 0,\$00007F,100, 50,\$0000FF,100, 100,\$00007F,100
<a href="#">#CCR</a>	6, 0,\$7F7F00,100, 50,\$FFFF00,100, 100,\$7F7F00,100
	Define touch button line style for normal and pressed down states
<a href="#">#CLS</a>	5, \$FFFFFF,100,1
<a href="#">#CLS</a>	6, \$FFFFFF,100,1
	Define touch button colour gradients as being linear with 90° torsion
<a href="#">#CFL</a>	5,5,90
<a href="#">#CFL</a>	6,6,90
	Define touch button style
<a href="#">#CBD</a>	1, 5,6, 200,50,10
	Define touch button text style
<a href="#">#CBT</a>	1, 1,1
	Define touch button change in proportion for pressed down state
<a href="#">#CBO</a>	1,0,0,0
	Set elliptical touch button to position 400,240.
<a href="#">#TBR</a>	1, 1, "Normal"; "Pushed"; 400,240
	
<b>Elliptical touch button</b>	
	Change text orientation
<a href="#">#CTA</a>	1,1
	Define touch button colour gradients for normal and pressed down states
<a href="#">#CCR</a>	5, 0,\$00007F,100, 50,\$0000FF,100, 100,\$00007F,100
<a href="#">#CCR</a>	6, 0,\$7F7F00,100, 50,\$FFFF00,100, 100,\$7F7F00,100
	Define touch button line style for normal and pressed down states
<a href="#">#CLS</a>	5, \$FFFFFF,100,1
<a href="#">#CLS</a>	6, \$FFFFFF,100,1
	Define touch button colour gradients as being linear with 90° torsion
<a href="#">#CFL</a>	5,5,90
<a href="#">#CFL</a>	6,6,90
	Define touch button style
<a href="#">#CBD</a>	1, 5,6, 200,50,10
	Define touch button text style
<a href="#">#CBT</a>	1, 1,1
	Define touch button change in proportion for pressed down state
<a href="#">#CBO</a>	1,0,0,0
	Set elliptical touch button to position 400,240.
<a href="#">#TSE</a>	1, 1, "Normal"; "Pushed"; 400,240
	

TIME

#WGC

**Object group as a clock**

Refrain from defining a line style and white filling for hour hand  
[#CLD](#) 11  
[#CFC](#) 11, \$FFFFFF, 100  
 Refrain from defining a line style and grey filling for minute hand  
[#CLD](#) 12  
[#CFC](#) 12, \$E0E0E0, 100  
 Refrain from defining a line style and red filling for second hand  
[#CLD](#) 13  
[#CFC](#) 13, \$FF0000, 100  
 Create colour gradient  
[#CCR](#) 9, 0,\$0,100 100, \$A0A0A0, 100  
 Define colour gradient and no line style for connecting point  
[#CFR](#) 14, 9  
[#CLD](#) 14  
 Set integer register  
[#VRI](#) 1,(scrW()/2),(scrH()/2)  
 Place graphic of the dial  
[#PPP](#) 5, "Clock3"; R1, R2, 5, 200  
 Place the three hands and connecting point  
[#GPF](#) 6, 11, 0, 0, 4, 75, 8, 0  
[#GPF](#) 7, 12, 0, 0, 4, 95, 8, 0  
[#GRR](#) 8, 13, 0, 0, 7, 2, 95  
[#GET](#) 9, 14, R1, R2, 5, 7  
 Define free anchors for hands  
[#OAO](#) 4, 15, 6-7  
[#OAO](#) 1, 20, 8  
 Change the position of the hands absolutely  
[#OPA](#) R1, R2, 6-8  
 Create object group  
[#OGA](#) 10, 5-9  
 Define object group as a clock  
[#WGC](#) 10, 6, 7, 8



**DRAWING/GRAPHIC PRIMITIVES**

**Graphic drawing objects**

**Rounded rectangle with border**

Define line style

**#CLS** 1, \$00FF00,100, 5

Define filling

**#CFC** 1, \$FF0000,100

Rounded rectangle with border, a type of picture frame

**#GRR** 1,1, 400,240,5, 200,100,20, 15

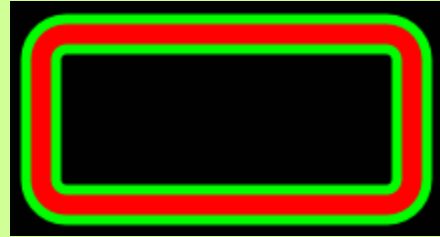

**Polyline - Santa Claus house**

Define line style

**#CLS** 1, \$00FF00,100, 2

Refrain from defining a filling

**#CFD** 1

Draw a Santa Claus house with the aid of a polypath

**#GPL** 1,1,20,20, 20,100, 70,100, 70,20, 20,20, 70,100, 45,130, 20,100, 70,20

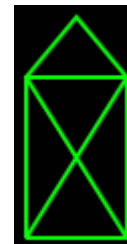

**Filled-in polyline - trapezium**

Define line style

**#CLS** 1, \$00FF00,100, 3

Define filling

**#CFC** 1, \$FF0000,100

Draw a filled-in trapezium with the aid of a polypath

**#GPF** 1,1, 20,20, 60,80, 160,80, 120,20

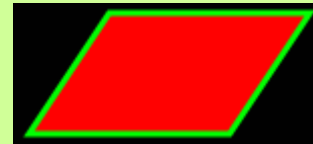

**Extend a polyline - Santa Claus house**

Define line style

**#CLS** 1, \$00FF00,100, 2

Refrain from defining a filling

**#CFD** 1

Draw a Santa Claus house with polypath from lines

**#GPL** 1,1, 20,20, 20,100, 70,100, 70,20, 20,20, 70,100, 45,140, 20,100, 70,20

Extend the Santa Claus house by the 3rd dimension

**#GPA** 1, 1,20,20, 20,100, 70,100, 70,20, 20,20, 70,100, 45,130, 20,100, 70,20

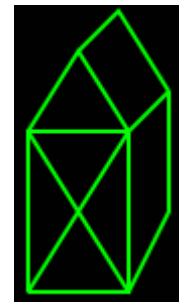

**Polypath - Draw a car**

Define line style

**#CLS** 1, \$00FF00,100, 2

Define filling

**#CFC** 1, \$FF0000,100

Draw a car using path segments

**#GPP** 1,1, 50,200, ?v-50, ?h150, ?c0,70,130,0, ?h200, ?c0,70,130,0, ?h90, ?v100, ?h-85, ?l-40,65, ?h-220, ?q-40,0,-145,-75, ?h-130, ?z

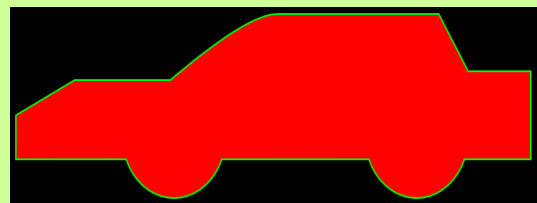

**Graphic drawing objects**

**Hexagon**

Define line style

**#CLS** 1, \$00FF00,100, 3

Define filling

**#CFC** 1, \$FF0000,100

A hexagon rotated by 90°

**#GGP** 1, 1 400,240,5, 100,6,0, 90

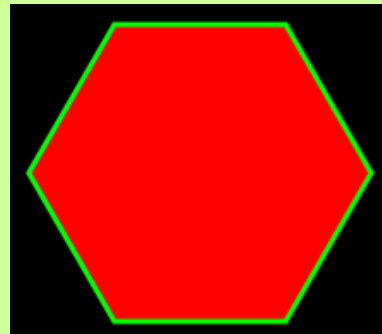

**Five-point star**

Define line style

**#CLS** 1, \$00FF00,100, 3

Define filling

**#CFC** 1, \$FF0000,100

Draw a filled-in star

**#GGS** 1, 1 400,240,5, 100,50, 5



**Tyres**

Define line style

**#CLS** 1, \$00FF00,100, 3

Define filling

**#CFC** 1, \$FF0000,100

Draw a circle with a hole

**#GET** 1, 1 400,240,5, 100,100, 30

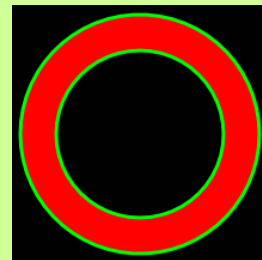

**Arc of a circle**

Define line style

**#CLS** 1, \$00FF00,100, 3

Define filling

**#CFC** 1, \$FF0000,100

Draw a letter "C" as an arc of a circle

**#GEA** 1, 1 400,240,5, 100,100, 45,-45, 30



**Graphic drawing objects**

**Cut segments of a circle**

Define line style

[#CLS](#) 1, \$00FF00, 100, 3

Define filling

[#CFC](#) 1, \$FF0000, 100

Draw two cut segments of a circle

[#GES](#) 1, 1, 400, 200, 5, 100, 100, 90, 0

[#GES](#) 2, 1, 450, 200, 5, 100, 100, 180, 60

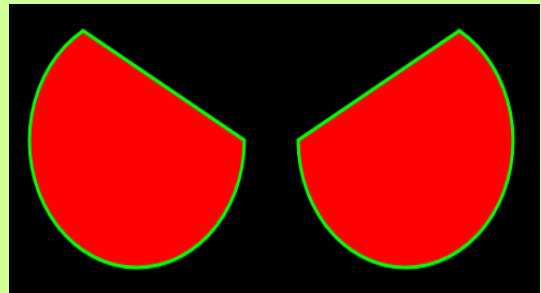

**Piece of cake**

Define line style

[#CLS](#) 1, \$00FF00, 100, 3

Define filling

[#CFC](#) 1, \$FF0000, 100

Draw a piece of cake

[#GEP](#) 1, 1 400, 240, 5, 100, 100, 135, 225

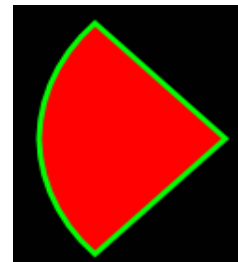

**SEGEMENT TYPES**

**Segments H(orizontal), V(ertical), L(inear)**

**Horizontal polypath**  
Define line style  
[#CLS](#) 1, \$00FF00,100, 3  
Refrain from defining an outline  
[#CFD](#) 1  
Generate a horizontal line as a polypath  
[#GPP](#) 1, 1, 10, 50, ?H 300



**Vertical polypath**  
Define line style  
[#CLS](#) 1, \$00FF00,100, 3  
Refrain from defining a filling  
[#CFD](#) 1  
Generate a vertical line as a polypath  
[#GPP](#) 1, 1, 50, 50, ?V 150

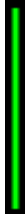

**Line polypath**  
Define line style  
[#CLS](#) 1, \$00FF00,100, 3  
Refrain from defining an outline  
[#CFD](#) 1  
Generate a line as a polypath  
[#GPP](#) 1, 1, 50,50, ?L 250,100



**Segmente C(ircle), E(llipse)**

**Circle segment polypath**

```

Define green line style
#CLS 5, $00FF00, 100, 3
Refrain from defining a filling
#CFD 5
Define grey line style
#CLS 6, $BFBFBF, 100, 1
Define a grey filling
#CFC 6, $7F7F7F, 100
Draw a polypath as a circle segment
#GPP 1, 5, 200, 200, ?C0, 120, 400, 200
Create dots/circles
#GET 2, 6, 200, 200, 5, 5
#GET 3, 6, 400, 200, 5, 5
#GET 6, 6, 300, 311, 5, 5
#GET 7, 6, 300, 89, 5, 5
Draw a grey arc
#GEA 4, 2, 200, 200, 0, 150, 150 -65, 65
#GEA 5, 2, 400, 200, 0, 150, 150, 115, -115
Change text size
#CTS 1, 28
Place strings
#SSP 8, 1, 180, 200, 6, "start"
#SSP 9, 1, 310, 311, 4, "r ccw"
#SSP 10, 1, 310, 89, 4, "r cw"
#SSP 11, 1, 410, 200, 4, "x|y"

```

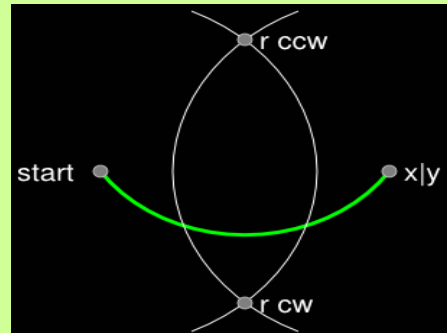

**Ellipse polypath**

```

Define green line style
#CLS 5, $00FF00, 100, 3
Refrain from defining a filling
#CFD 5
Define grey line style
#CLS 6, $BFBFBF, 100, 1
Define a grey filling
#CFC 6, $7F7F7F, 100
Set integer register
#VRI 0, 110, 150
Polypath ellipse green and grey
#GPP 1, 5, 200, 300, ?E1, R0, R1, 0, 400, 300
#GPP 4, 2, 200, 300, ?E2, R0, R1, 0, 400, 300
Set dots/circles
#GET 2, 6, 200, 300, 5, 5
#GET 3, 6, 400, 300, 5, 5
Change text size
#CTS 1, 28
Set strings
#SSP 8, 1, 180, 300, 6, "start"
#SSP 11, 1, 410, 300, 4, "x|y"

```

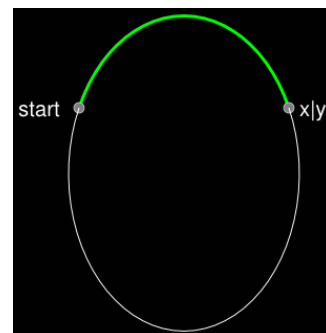



## Segmente Q(uadratische Bézier Kurve), R

### Polypfad quadratische Bézierkurve

```

Grünen Linienstyle definieren
#CLS 5, $00FF00,100, 3
Keine Umrandung definieren
#CFD 5
Grauen Linienstyle definieren
#CLS 6, $BFBFBF,100, 1
Graue Füllung definieren
#CFC 6, $7F7F7F,100
Integer Register setzen
#VRI 0,250,200
Quadratische Bezierkurve zeichnen
#GPP 1, 5, 200,300,?QR0,R1,400,300
Punkte/Kreise setzen
#GET 2, 6, 200,300,5, 5
#GET 3, 6, 400,300,5, 5
#GET 4, 6, R0,R1,5, 5
Geraden zeichnen
#GPL 5, 2, 200,300, R0,R1
#GPL 6, 2, 400,300, R0,R1
Textgröße ändern
#CTS 1, 28
Strings setzen
#SSP 8, 1, 180,300,6, "start"
#SSP 11, 1, 410,300,4, "x|y"

```

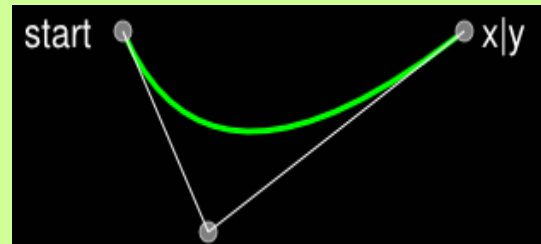

**Segmente Q(uadratische Bézier Kurve), R**

**Polypfad quadratische Bézierkurve mit Hilfspunkt**

```

Grünen Linienstyle definieren
#CLS 5, $00FF00,100, 3
Keine Füllung definieren
#CFD 5
Grauen Linienstyle definieren
#CLS 6, $BFBFBF,100, 1
Graue Füllung definieren
#CFC 6, $7F7F7F,100
Integer Register setzen
#VRI 0,210,200,300,300,460
Grünen Polypfad zeichnen
#GPP 1, 5, 200,R3,?QR0,R1,R2,R3, ?RR4,R3
Grauen Polypfad zeichnen
#GPL 2, 2,200,R3, R0,R1, R2,R3, (2*R2-R0),(2*R3-R1), R4,R3
Punkte/Kreise erzeugen
#GET 3, 6, 200,300,5, 5
#GET 4, 6, R0,R1,5, 5
#GET 6, 6, R2,R3,5, 5
#GET 7, 6, R2,R3,5, 5
#GET 8, 6, R4,300,5, 5
#GET 9, 6, (2*R2-R0),(2*R3-R1),5, 5
Schwarze Füllung mit 50% Deckkraft definieren
#CFC 4, $000000, 50
Rechteck erzeugen zum Abdunkeln
#GRR 5, 4, 195,(R1-5),7, (R2-R1+10), (R3-R1+10)
Textgröße ändern
#CTS 1, 28
Strings platzieren
#SSP 10, 1, (R2-10),(R3+5),6, "start"
#SSP 11, 1, (2*R2-R0-10),(2*R3-R1),6, "reflection point"
#SSP 12, 1, (R4+10),R3,4, "x|y"

```

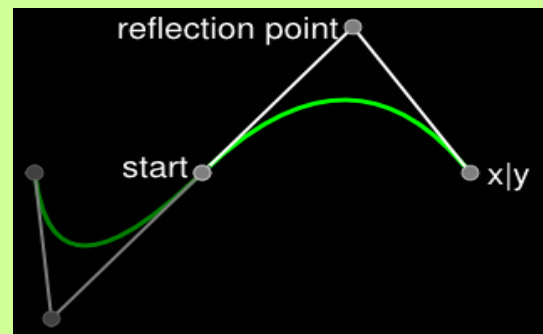

## Segmente T, S(pline)

### Polypfad Spline

```

Grünen Linienstyle definieren
#CLS 5, $00FF00,100, 3
Keine Füllung definieren
#CFD 5
Grauen Linienstyle definieren
#CLS 6, $BFBFBF,100, 1
Graue Füllung definieren
#CFC 6, $7F7F7F,100
Spline zeichnen
#GPP 1, 5, 100,50,?S150,100,250,100,300,50
Geraden Zeichnen
#GPL 2, 6, 100,50,150,100
#GPL 3, 6, 300,50,250,100
Punkte/Kreise erzeugen
#GET 4, 6, 150,100,5, 5
#GET 5, 6, 250,100,5, 5
#GET 6, 6, 100, 50,5, 5
#GET 7, 6, 300, 50,5, 5
Textgröße ändern
#CTS 1, 28
Strings platzieren
#SSP 8, 1, 90, 50,6, "start"
#SSP 9, 1, 150,110,8, "c1x|c1y"
#SSP 10, 1, 250,110,8, "c2x|c2y"
#SSP 11, 1, 310, 50,4, "x|y"

```

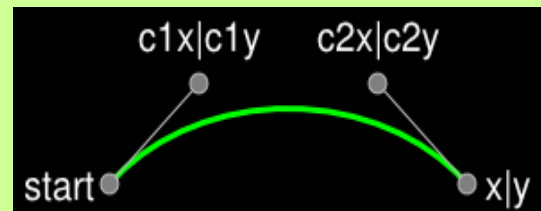

## Segmente T, S(pline)

### Polypfad geglättete kubische Bézierkurve

```

Grünen Linienstyle definieren
#CLS 5, $00FF00,100, 3
Keine Füllung definieren
#CFD 5
Grauen Linienstyle definieren
#CLS 6, $BFBFBF,100, 1
Graue Füllung definieren
#CFC 6, $7F7F7F,100
Integer Register setzen
#VRI 0, 200,200, -10,80, 60,40, 80,0, 70,-35, 100,0
Grünen Polypfad erzeugen
#GPP 1, 5, R0,R1,?sR2,R3,R4,R5,R6,R7, ?tR8,R9,R10,R11
Polypfad aus Geraden erzeugen
#GPL 9, 2, R0,R1, (R0+R2),(R1+R3), (R0+R4),(R1+R5), (R0+R6),
(R1+R7), (R0+2*R6-R4),(R1-R5), (R0+R6+R8),(R1+R7+R9),
(R0+R6+R10),(R1+R7+R11)
Punkte/Kreise erzeugen
#GET 2, 6, R0,R1,5, 5
#GET 3, 6, (R0+R2),(R1+R3),5, 5
#GET 4, 6, (R0+R4),(R1+R5),5, 5
#GET 5, 6, (R0+R6),(R1+R7),5, 5
#GET 6, 6, (R0+2*R6-R4),(R1-R5),5, 5
#GET 7, 6, (R0+R6+R8),(R1+R7+R9),5, 5
#GET 8, 6, (R0+R6+R10),(R1+R7+R11),5, 5
Schwarze Füllung mit 50% Deckkraft definieren
#CFC 4, $000000, 50
Rechteck erzeugen zum Abdunkeln
#GRR 20, 4, (R0-5+R2),(R1-5),7, (R6-R2+10),(R1+R3+5)
Textgröße ändern
#CTS 1, 28
Strings platzieren
#SSP 10, 1, (R0+R6+10),(R1+R7),4, "start"
#SSP 11, 1, (R0+2*R6-R4),(R1-R5-5),2, "reflection point"
#SSP 12, 1, (R0+R6+R8+10),(R1+R7+R9),4, "c2x|c2y"
#SSP 13, 1, (R0+R6+R10+10),(R1+R7+R11),4, "x|y"

```

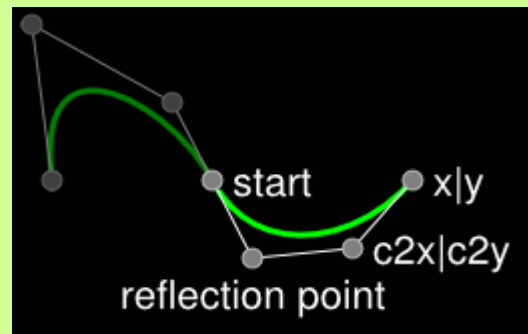

## Segmente Z, M

### Polyfad schließen

```

Grünen Linienstyle definieren
#CLS 5, $00FF00, 100, 3
Keine Füllung definieren
#CFD 5
Grauen Linienstyle definieren
#CLS 6, $BFBFBF, 100, 1
Graue Füllung definieren
#CFC 6, $7F7F7F, 100
Integer Register setzen
#VRI 0, 200, 200, 100, 70, 200, 0
Polyfad mit Pfadstop definieren
#GPP 1, 5, R0, R1, ?e1, R2, R3, 0, R4, R5, ?Z
Punkte/Kreise zeichnen
#GET 2, 6, R0, R1, 5, 5
#GET 3, 6, (R0+R4), (R0+R5), 5, 5
Textgröße ändern
#CTS 1, 28
Strings platzieren
#SSP 10, 1, (R0-10), (R1), 6, "start"
#SSP 11, 1, (R0+R4+10), (R0+R5), 4, "end"
#SSP 12, 1, (R0+R4/2), (R1-5), 2, "close path"

```

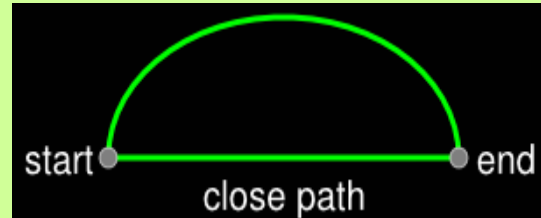

### Polyfad Sprung

```

Grünen Linienstyle definieren
#CLS 5, $00FF00, 100, 3
Rote Füllung definieren
#CFD 5, $FF0000, 100
Grauen Linienstyle definieren
#CLS 6, $BFBFBF, 100, 1
Graue Füllung definieren
#CFC 6, $7F7F7F, 100
Integer Register setzen
#VRI 0, 200, 200, 100, 100, 10
Quadrat mit Kreis in der Mitte zeichnen
#GPP 1, 5, R0, R1, ?hR2, ?vR3, ?h(-R2), ?Z, ?M((R0+R2/2), (R1+R4), ?c1,
((R3-2*R4)/2), 0, (R3-2*R4), ?c1, ((R3-2*R4)/2), 0, (2*R4-R3)
Punkte/Kreise setzen
#GET 2, 6, R0, R1, 5, 5
#GET 3, 6, (R0+R2/2), (R1+R4), 5, 5
Textgröße ändern
#CTS 1, 28
Strings setzen
#SSP 4, 1, (R0-10), (R1), 6, "start"
#SSP 5, 1, (R0+R2/2), (R1+R4+5), 8, "Move"

```

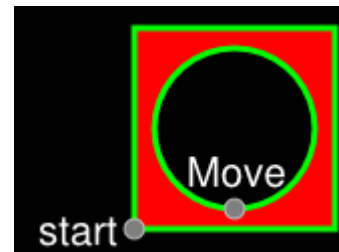

**ELECTRICAL SPECIFICATION**

Value	Condition	min.	typ.	max.	Unit
Operating temperature		-20		+70	°C
Storage temperature		-30		+80	°C
Storage humidity				90% RH	@ 60°C
Operating voltage		3.1	3.3	3.5	V
Supply current	Backlight 100%		750		mA
	Backlight 0%		350		mA
Input low voltage (except USB, I/O)		-0.3	0	0.3*VDD	V
Input high voltage (except USB, I/O)		VDD*0.7		VDD+0.3	V
Output low voltage (except USB, I/O)		-	-	0.4	V
Output high voltage (except USB, I/O)		VDD-0.5	-	-	V
Input low voltage I/O		-	-	0.2*VDD	V
Input high voltage I/O		0.8*VDD	-	-	V
Output low voltage I/O		-	-	0.6*VDD	V
Output high voltage I/O		VDD-0.7	-	-	V
Output current I/O		-	-	25	mA
		-	-	125	mA (total)
I <sup>2</sup> C-bus pull-up				1	MΩ
Brightness	w./o. Touchpanel		700		cd/m <sup>2</sup>
	with Capactive Touchpanel				
	with Resistive Touchpanel				

## DIMENSIONS

