

REV.	ECN NO.	DATE	SIGN	DESCRIPTION
A	Initial Release	2016/12/01	Wes Fan	Change Rev.01 To Rev.A

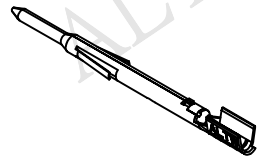

Male Pin

OR

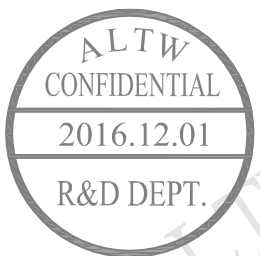
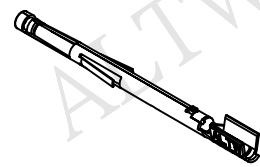

Female Pin

X 50 PCS or 100 PCS

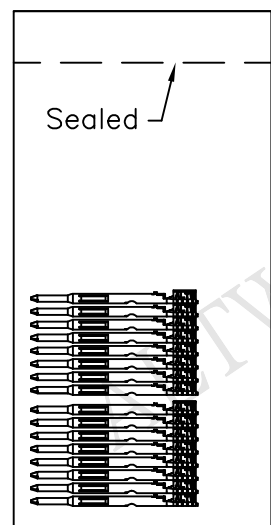

PE Bag

X 1 PCS

Each 50 pcs or 100 pcs pins into a PE bag.

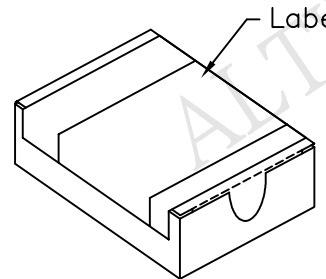

Carton Box: L65 X W55X H25

OR

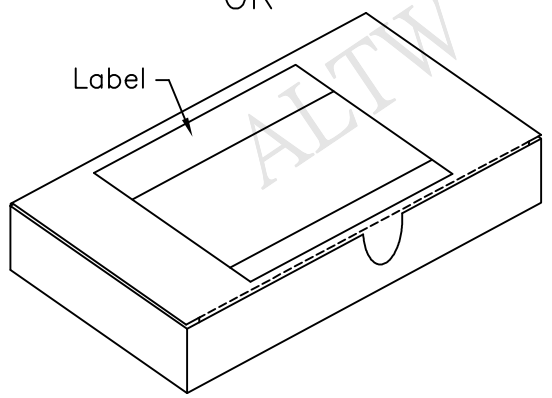

Carton Box: L130 X W55X H25

Each bag with pins into a carton box.
Each carton box with a label.

Notes:

- * Pins Material: Phosphor Bronze.
- * Bag Material: PE, Clean.
- * Box Material: Corrugated Carton, T=1.5mm
Carton Interior Dimensions: L130 X W55X H25
L65 X W55X H25

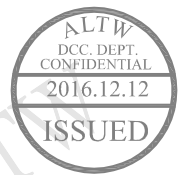

UNIT:mm	TITLE X-LOK,STPIN,ASSY,CRIMP	
TOLERANCE ±0.5 mm	SCALE Free	SHEET 1 OF 2
REV. A	SIZE A4	QC :Inspection Item

Amphenol LTW
安費諾亮泰企業股份有限公司

ITEM NO ASSP-XX-X-A-C-SX	DRAWN BY Wes Fan	DATE 2016/12/01
DWG NO ASSP-XX-X-A-C-SX	CHECKED BY Victor Hung	DATE 2016/12/01
CUSTOMER ALTW	APPROVED BY Kevin Hu	DATE 2016/12/01

THIS DOCUMENT IS SUBJECT TO CHANGE WITHOUT NOTICE. IT IS CONFIDENTIAL AND A PROPERTY OF Amphenol LTW. DISCLOSURE TO THIRD PARTY HAS TO BE AUTHORIZED BY Amphenol LTW.

A B C D E F

1 2 3 4 5 6 7 8

REV. A	ECN NO.	DATE	SIGN	DESCRIPTION
	Initial Release	2016/12/01	Wes Fan	Change Rev.01 To Rev.A

Ordering Information:

ASSP-XX-X-A-C-SX

Package Style

SA: Scatter 50Pcs By Box.
SB: Scatter 100Pcs By Box

Contact Gender

M: Male Pin
F: Female Pin

Current Rating

05: 5A
10: 10A
20: 20A

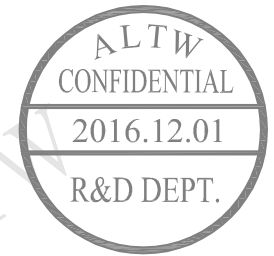
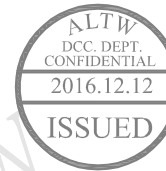

05A Pins

10A Pins

20A Pins

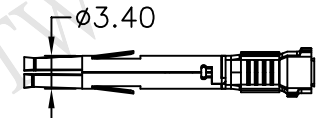
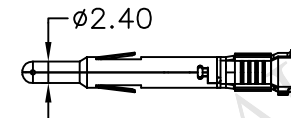
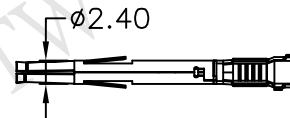
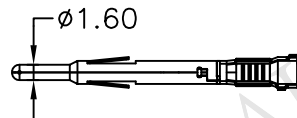
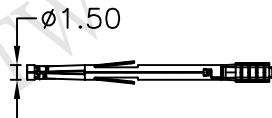
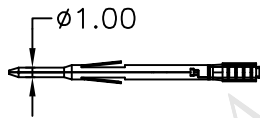
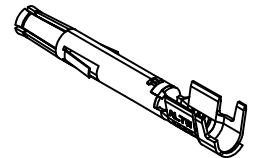
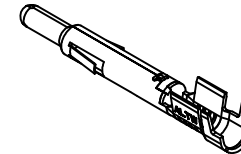
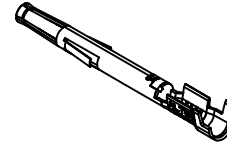
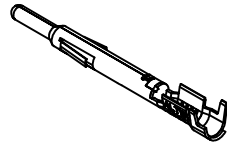
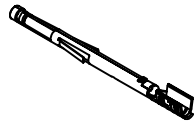
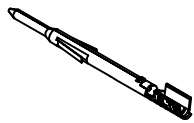

Male Pin

Female Pin

Male Pin

Female Pin

Male Pin

Female Pin

UNIT:mm	
TOLERANCE	
±0.5 mm	

TITLE X-LOK,STPIN,ASSY,CRIMP		
SCALE	Free	SHEET 2 OF 2
REV. A	SIZE A4	QC :Inspection Item

Amphenol LTW
安費諾亮泰企業股份有限公司

ITEM NO ASSP-XX-X-A-C-SX	DRAWN BY Wes Fan	DATE 2016/12/01
DWG NO ASSP-XX-X-A-C-SX	CHECKED BY Victor Hung	DATE 2016/12/01
CUSTOMER ALTW	APPROVED BY Kevin Hu	DATE 2016/12/01

THIS DOCUMENT IS SUBJECT TO CHANGE WITHOUT NOTICE. IT IS CONFIDENTIAL AND A PROPERTY OF Amphenol LTW. DISCLOSURE TO THIRD PARTY HAS TO BE AUTHORIZED BY Amphenol LTW.

F
E
D
C
B
A