

SFB 180 x 38 x 45 MM SERIES

DIMENSIONS DRAWING

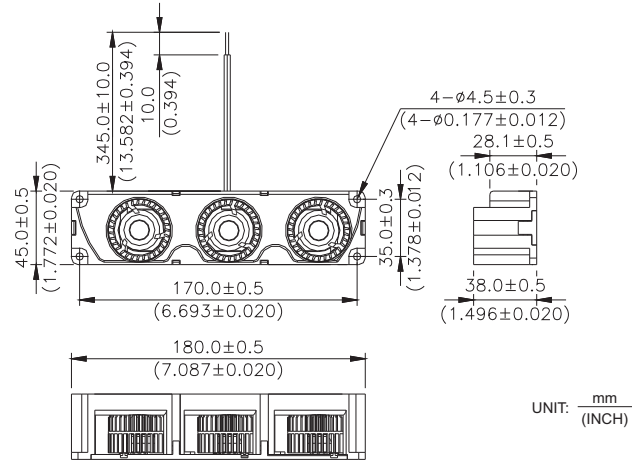

- * Bearing Type
Ball Bearings
- * Material
Impeller & Frame : Plastic(UL 94V-0)
- * Lead Wires :
UL 1007 AWG #24 OR Equivalent
Red Wire Positive(+)
Black Wire Negative(-)
- * Weight : 150g (5.29 OZ)

P & Q CURVE (AT RATED VOLTAGE)



MOUNTING PANEL CUTOUT



MODEL		Rated Voltage	Operating Voltage Range	Input Current	Input Power	Speed	Maximum Air Flow		Maximum Air Pressure		Noise
PART NO.	FUNCTION	VDC	VDC	Amp	Watt	R.P.M.	m ³ /min	CFM	mmH ₂ O	IN H ₂ O	dB-A
SFB0312L	-R00 / -F00	12	5.5 to 13.8	0.35	4.20	3600	0.467	16.49	3.95	0.156	37.0
SFB0312M	-R00 / -F00	12	5.5 to 13.8	0.55	6.60	5000	0.676	23.87	8.25	0.325	46.5
SFB0312H	-R00 / -F00	12	5.5 to 13.8	0.63	7.56	6400	0.873	30.83	14.19	0.559	50.0
SFB0312HH	-R00 / -F00	12	5.5 to 13.8	0.93	11.16	7000	0.968	34.18	17.00	0.669	53.0

- * Function type is optional.
- * The max. air flow and the speed are measured in free air ; max. air pressure is measured at zero air flow.
- * Noise is measured in anechoic chamber in free air, one meter from intake side.
- * All readings are typical values at rated voltage.
- * Specifications are subject to change without notice.