

LTC3880EUJ PolyPhase Step-Down DC/DC Converter with Digital Power System Management

DESCRIPTION

Demonstration circuit 1740A is a PolyPhase[®] synchronous buck converter featuring the LTC[®]3880EUJ, a dual-phase current mode controller with PMBus interface and digital power system management functions. There are two versions of the boards available:

- DC1740A-A: 4-phase single-output configuration. Default output setting $V_{OUT0} = 1.2V/80A$
- DC1740A-B: 3+1-phase dual-output configuration. Default output setting $V_{OUT0} = 1.5V/20A$, $V_{OUT1} = 1.2V/60A$

The DC1740A powers up to default settings and produces power based on configuration resistors or with non-volatile memory (NVM) settings without the need for any serial bus communication. This allows easy evaluation of the DC/DC converter aspects of the LTC3880. To fully explore the extensive digital power management features of the parts, download the GUI software

LTpowerPlay[™] onto your PC and use LTC's I²C/SMBus/PMBus Dongle DC1613A to connect to the board. LTpowerPlay allows the user to reconfigure the part on the fly and store the configuration in EEPROM, view telemetry of voltage, current, temperature and fault status.

GUI Download

The software can be downloaded from:

<http://www.analog.com/en/design-center/ltpower-play>

For more digital power system management information and instructions of LTpowerPlay, please visit:

<http://www.analog.com/en/products/landing-pages/001/power-systems-management>

Design files for this circuit board are available.

All registered trademarks and trademarks are the property of their respective owners.

PERFORMANCE SUMMARY Specifications are at $T_A = 25^\circ C$

SYMBOL	PARAMETER	CONDITIONS	MIN	TYP	MAX	UNITS
V_{IN}	Input Supply Range		7	12	14	V
V_{OUT0}	Output Voltage Range (1740A-A version)	$I_{OUT0} = 0A$ TO 80A, $V_{IN} = 7V$ to 14V	0.5	1.2	4.096	V
I_{OUT0}	Output Current Range (1740A-A version)		0		80	A
V_{OUT0}	Output Voltage Range (1740A-B version)	$I_{OUT0} = 0A$ TO 20A, $V_{IN} = 7V$ to 14V	0.5	1.5	4.096	V
I_{OUT0}	Output Current Range (1740A-B version)		0		20	A
V_{OUT1}	Output Voltage Range (1740A-B version)	$I_{OUT1} = 0A$ TO 60A, $V_{IN} = 7V$ to 14V	0.5	1.2	4.096	V
I_{OUT1}	Output Current Range (1740A-B version)		0		60	A
F _{SW}	Factory Default Switching			425		kHz
EFF	Peak Efficiency (-A version)	$V_{OUT0} = 1.2V$, See Figure 4		88.6		%

QUICK START PROCEDURE

Demonstration circuit 1740A makes it easy to set up to evaluate the performances of the LTC3880. Refer to Figure 2 for proper measurement equipment setup and follow the procedure below:

Note: When measuring the input or output voltage ripple, care must be taken to avoid a long ground lead on the oscilloscope probe. Measure the output voltage ripple by touching the probe tip directly across the C11 or C44. See Figure 3 for proper scope probe technique.

1. Make sure jumpers are in the following positions:

DC1740A-A Version

JUMPER	POSITION	FUNCTION
JP2	C	Tie RUN0 to RUN1
JP3	ON	3.3V for LED indicator
JP4	OFF	External V _{CC} for LTC3880-1
JP5	C	Tie GPIO0B to GPIO1B

DC1740A-B Version

JUMPER	POSITION	FUNCTION
JP2	NC	Tie RUN0 to RUN1
JP3	ON	3.3V for LED indicator
JP4	OFF	External V _{CC} for LTC3880-1
JP5	NC	Tie GPIO0B to GPIO1B

2. With power off, connect the input power supply to V_{IN} and GND. Connect active load to the output.

3. Make sure both RUN switches are OFF.
4. Turn on the power at the input.
Note: Make sure that the input voltage does not exceed 15V.
5. Turn on RUN switches as desired.
6. Check for the correct output voltage from TP15 to TP16 and from TP24 to TP26.
Note. If there is no output, temporarily disconnect the load to make sure that the load is not set too high.
7. Once the proper output voltage is established, adjust the loads within the operating range and observe the output voltage regulation, ripple voltage, efficiency and other parameters.
8. Connect the dongle and control the output voltages from the GUI. See LTpowerPlay Quick Start section for details.

Connecting a PC to DC1740A

You can use a PC to reconfigure the power management features of the LTC3880 such as: nominal V_{OUT}, margin set points, OV/UV limits, temperature fault limits, sequencing parameters, the fault log, fault responses, GPIO and other functionality. The DC1613A dongle may be plugged in regardless of whether or not V_{IN} is present. Dongle can be hot plugged.

QUICK START PROCEDURE

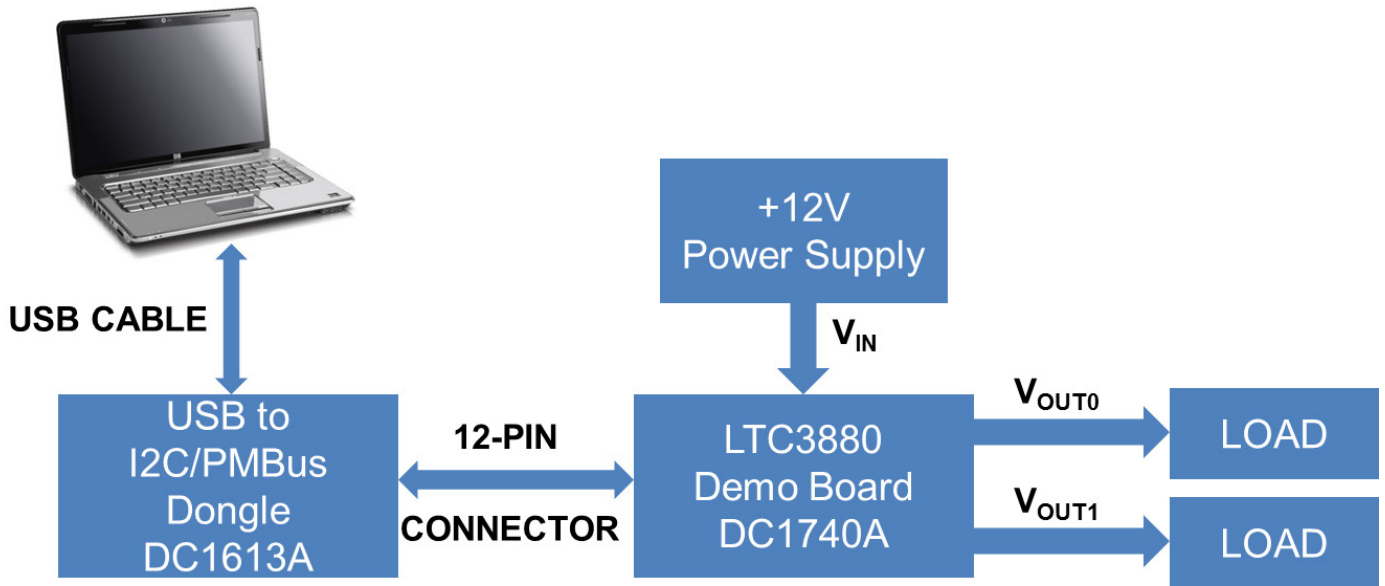

Figure 1. Demo Setup with PC

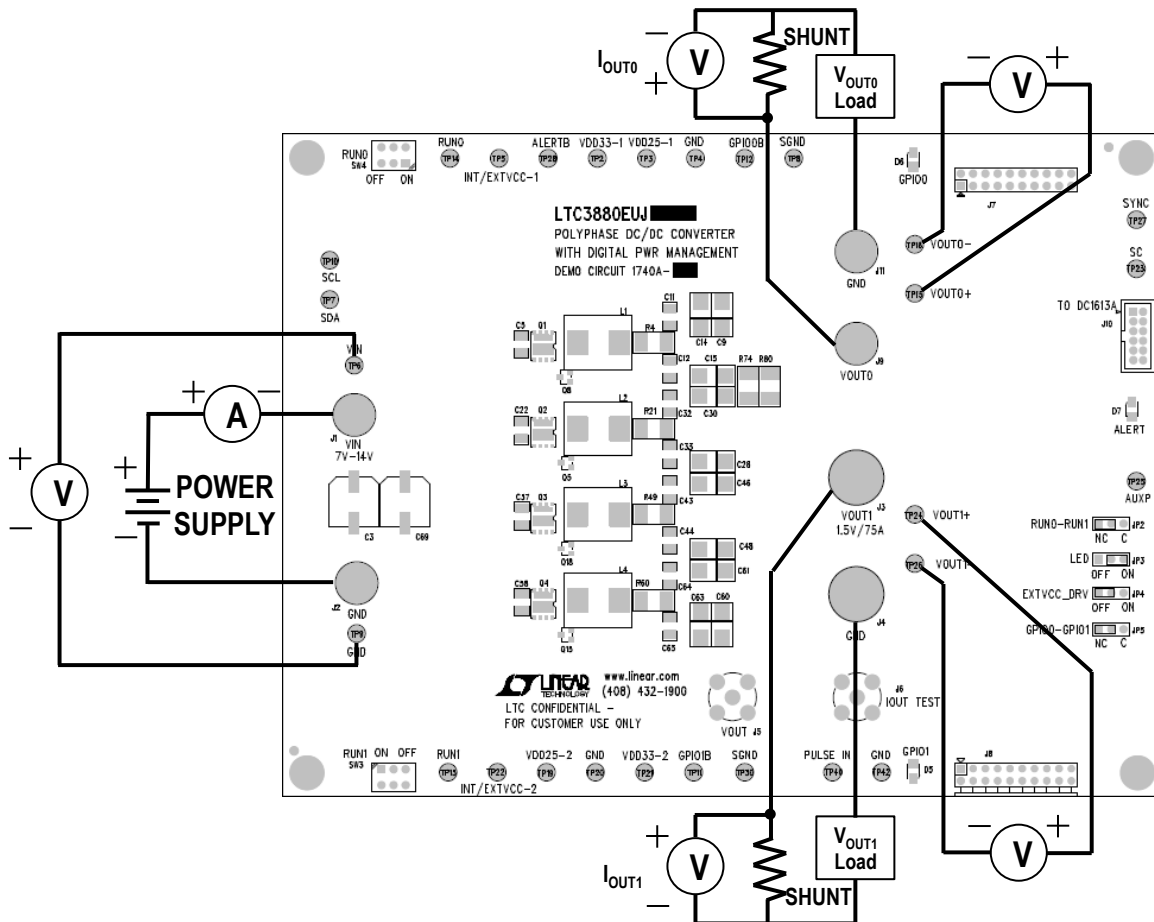

Figure 2. Power Test Setup (Dual-Output example)

QUICK START PROCEDURE

Combining DC1740A with Other Digital Power Demo Boards

The DC1740A may be plugged together in a multi-board array with other LTC power system management boards using J7 and J8.

Measuring Efficiency (See Figure 4)

To accurately measure efficiency of any configuration, do the following:

- Remove R103, R111 (bleeder resistors on bottom side of board)
- Set JP3 to OFF to disable the regulator that provides power to various auxiliary demo board components like LEDs.
- Measure V_{IN} across the input ceramic capacitor (C5, C37). Measure V_{OUT} across the output ceramic capacitor (C11, C44).

Evaluating the LTC3880-1

For applications that require the highest possible efficiency, the LTC3880-1 allows the user to supply the bias voltage and gate driver current from an external power supply. Connect the external power supply, 4.8V to 5.2V, to the $EXTV_{CC}$ pin.

To use the onboard LDO to drive $INTV_{CC}$, make the following modifications to the demo board:

- Set JP4 to ON so that U5 provides the 5V drive to $INTV_{CC}$. U5 takes the place of the external power supply.
- Install R1,R46.

To accurately measure efficiency of a demo board containing the LTC3880-1,

- Drive $INTV_{CC}$ from an external source through the pin named: $EXTV_{CC}$.
- Set JP3 and JP4 to OFF to disable the LDOs.
- Measure V_{IN} across the input ceramic capacitor (C5, C37). Measure V_{OUT} across the output ceramic capacitor (C11, C44).

Measuring Output Ripple Voltage

An accurate ripple measurement may be performed by using the Figure 3 configuration across C11 or C44.

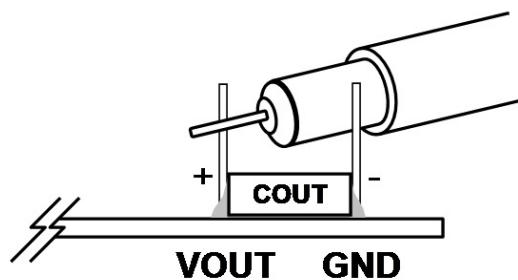

Figure 3. Measuring Output Voltage Ripple

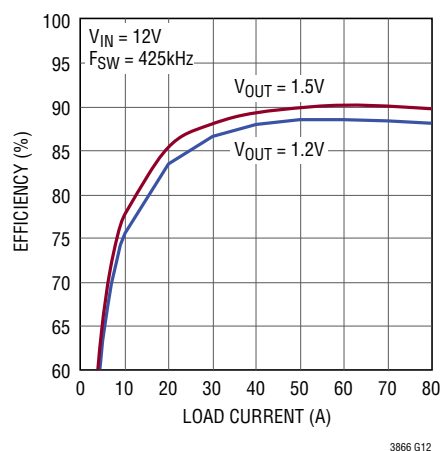

Figure 4. Typical Efficiency Curves DC1740A-A

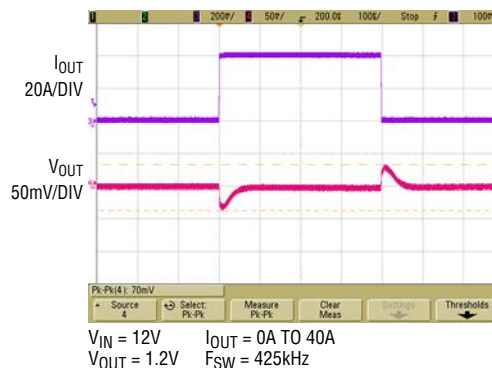

Figure 5. Load Transient Waveform DC1740A-A

LTpowerPlay SOFTWARE GUI

LTpowerPlay is a powerful Windows-based development environment that supports Linear Technology power system management ICs, including the LTC3880, LTC3883, LTC2974 and LTC2978. The software supports a variety of different tasks. You can use LTpowerPlay to evaluate Linear Technology ICs by connecting to a demo board system. LTpowerPlay can also be used in an offline mode (with no hardware present) in order to build a multi-chip configuration file that can be saved and reloaded at a later time. LTpowerPlay provides unprecedented diagnostic and debug features. It becomes a valuable diagnostic tool during board bring-up to program or tweak the power management scheme in a system, or to diagnose power

issues when bringing up rails. LTpowerPlay utilizes the DC1613A USB-to-SMBus controller to communicate with one of many potential targets, including the LTC3880's DC1740A demo system, or a customer board. The software also provides an automatic update feature to keep the software current with the latest set of device drivers and documentation. The LTpowerPlay software can be downloaded from:

<http://www.analog.com/en/design-center/ltpower-play>

To access technical support documents for LTC Digital Power Products visit Help. View online help on the LTpowerPlay menu.

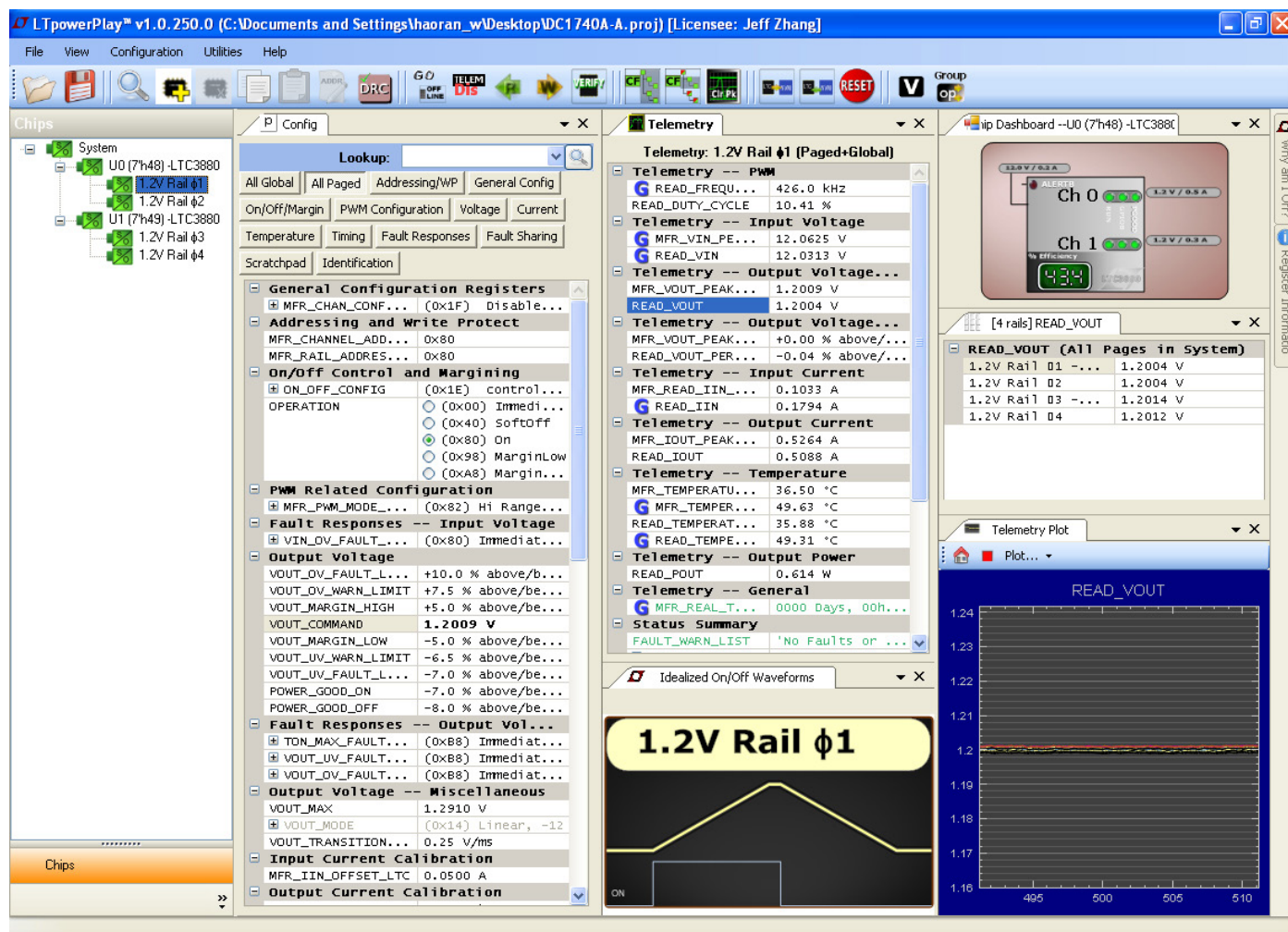

Figure 6. LTpowerPlay Main Interface

DEMO MANUAL DC1740A

LTpowerPlay QUICK START PROCEDURE

The following procedure describes how to use LTpowerPlay to monitor and change the settings of LTC3880 (taking DC1740A-A as an example).

1. Download and install the LTpowerPlay GUI:
<http://www.analog.com/en/design-center/ltpower-play>
2. Launch the LTpowerPlay GUI.
 - a. The GUI should automatically identify the DC1740A-A. The system tree on the left hand side should look like this:

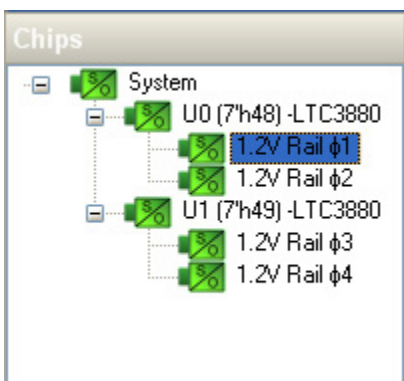

- b. A green message box shows for a few seconds in the lower left hand corner, confirming that the LTC3880s are communicating:

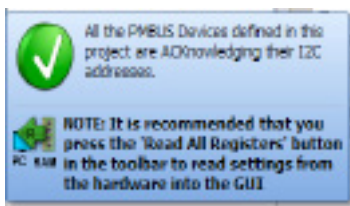

- c. In the Toolbar, click the “R” (RAM to PC) icon to read the RAM from the LTC3880. This reads the configuration from the RAM of LTC3880 and loads it into the GUI.



- d. If you want to change the output voltage to a different value, like 1.5V. In the Config tab, type in 1.5 in the VOUT_COMMAND box, like this:

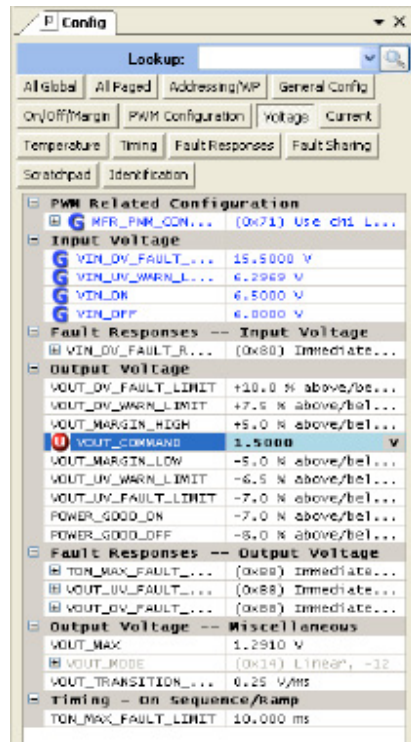

Then, click the “W” (PC to RAM) icon to write these register values to the LTC3880. After finishing this step, you will see the output voltage will change to 1.5V.



If the write is successful, you will see the following message:

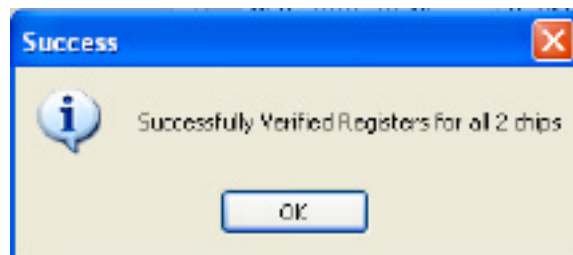

- e. You can save the changes into the NVM. In the tool bar, click “RAM to NVM” button, as following:



- f. Save the demo board configuration to a (*.proj) file. Click the Save icon and save the file. Name it whatever you want.

PARTS LIST

ITEM	QTY	REFERENCE	PART DESCRIPTION	MANUFACTURE/PART NUMBER
Required Circuit Components—DC1740A-A				
1	2	C1, C36	CAP., X5R, 4.7μF,16V, 10%, 0805	MURATA GRM219R61C475KE15D
2	1	C76	CAP., X5R, 4.7μF,16V, 10%, 0603	TDK C1608X5R1C475K
3	6	C2, C40, C20, C34, C53, C67	CAP., X5R, 0.22μF,16V, 10%, 0603	AVX 0603YD224KAT2A
4	2	C72, C78	CAP., X5R, 0.22μF,16V, 10%, 0805	AVX 0805YC224KAT2A
5	2	C3, C69	CAP., OS-CON, 150μF, 16V, 20%, F12	SANYO, 16SVP150M
6	3	C5, C22, C37	CAP., X5R, 10μF,16V, 10%, 1210	TAIYO YUDEN EMK325BJ106KN
7	1	C58	CAP., X5R, 10μF,16V, 10%, 1210	TAIYO YUDEN EMK325BJ106KN
8	1	C75	CAP., X5R, 10μF,16V, 10%, 1206	TAIYO YUDEN EMK316BJ106KD
9	5	C6, C26, C39, C59, C79	CAP., X5R, 100nF,25V, 10%, 0603	AVX 06033C104KAT2A
10	4	C7, C8, C41, C42	CAP., X5R, 1μF, 25V, 10%, 0603	AVX 06033D105KAT2A
11	2	C73, C77	CAP., X5R, 1μF, 16V, 10%, 1206	AVX 1206YD105KAT2A
12	16	C9, C10, C14, C15, C27, C28, C29, C30, C46, C47, C48, C49, C60, C61, C62, C63	CAP., POSCAP 330μF 4V D3L	SANYO, 4TPF330M9L
13	12	C11, C12, C13, C31, C32, C33, C43, C44, C45, C64, C65, C66	CAP., X5R, 100μF, 6.3V, 10%,1210	AVX 12106D107AT2A
14	1	C50	CAP., X7R, 4.7nF, 50V, 10%, 0603	NIC NMC0603X7R472K50TRPF
15	4	C18, C19, C51, C52	CAP., X7R, 100pF, 25V, 10%, 0603	AVX 06033C101JAT2A
16	4	C21, C35, C54, C68	CAP., X5R, 1μF, 25V, 10%, 0603	AVX 06033D105KAT2A
17	6	C23, C25, C56, C57, C70, C71	CAP., X5R, 10nF,16V, 10%, 0603	AVX 0603YC103KAT2A
18	4	D1, D2, D3, D4	DIODE, SCHOTTKY, SOD-323	CENTRAL CMDSH-3TR
19	4	L1, L2, L3, L4	INDUCTOR, SMT POWER IND. 0.4μH	COILCRAFT, XAL1060-401
20	4	Q1-Q4	DUAL N-CHANNEL MOSFET 25V LFAK	FAIRCHILD FDMS3620S
21	1	U1	IC, LTC3880EUJ, QFN 6mm x 6mm	ANALOG DEVICES, LTC3880EUJ#PBF
22	1	U2	IC, LTC3880EUJ, QFN 6mm x 6mm	ANALOG DEVICES, LTC3880EUJ#PBF
Additional Circuit Components—DC1740A-A				
1	2	D5, D6	LED GREEN S-GW TYPE SMD	PANASONIC LN1371SGTRP
2	1	D7	LED RED S-TYPE GULL WING SMD	PANASONIC LN1271RTR
3	0	Q7, Q9, Q10, Q11, Q12, Q13, Q14, Q16 (OPT)	MOSFET SPEED SRS 30V 30A LFAK	
4	4	Q5, Q8, Q15, Q18	TRANS GP SS PNP 40V SOT-23	ON SEMI, MMBT3906LT1G
5	1	Q21	N-CHANNEL 30-V MOSFET,TO-252	VISHAY, SUD50N03-10P-E3
6	3	Q22, Q25, Q26	MOSFET P-CH 20V 0.58A SOT-23	VISHAY TP0101K-T1-E3
7	2	Q23, Q24	MOSFET N-CH 60V 115MA SOT-23	FAIRCHILD 2N7002A
8	0	R1, R46, R126, R128 (OPT)	RES., 0805	
9	0	R11, R14, R24, R26, R28, R36, R37, R53,R54, R63, R65, R71, R73, R94, R117, R118, R124, R127, R129 (OPT)	RES., 0603	
10	29	R2, R3, R10, R16, R20, R22, R25, R27, R30, R45, R47, R48, R50, R52, R55, R8, R59, R61, R64, R66, R67, R68, R75, R89, R90, R95, R129, R77, R79	RES., CHIP, 0Ω, 0603	NIC NRC06ZOTRF
11	5	R109, R115, R116, R119	RES., CHIP, 0Ω, 0805	NIC NRC10ZOTRF
12	1	R41	RES., CHIP, 15k, 1%, 0603	NIC NRC06F1502TRF
13	4	R4, R21, R49, R60	RES., CHIP, 0Ω, 2010	TEPRO(NAKOMA) RN6083

DEMO MANUAL DC1740A

PARTS LIST

ITEM	QTY	REFERENCE	PART DESCRIPTION	MANUFACTURE/PART NUMBER
14	16	R5, R6, R7, R8, R29, R38, R39, R81, R82, R87, R88, R91, R96, R102, R110, R112	RES., CHIP, 10k, 1%, 0603	NIC NRC06f1002TRF
15	8	R13, R18, R23, R31, R51, R57, R62, R69	RES., CHIP, 1k, 1%, 0603	NIC NRC06F1001TRF
16	2	R56	RES., CHIP, 4.87k, 1%, 0603	NIC NRC06F4871TRF
17	3	R33, R32, R70	RES., CHIP, 20k, 1%, 0603	NIC NRC06F2002TRF
18	3	R34, R35, R72	RES., CHIP, 24.9k, 1%, 0603	NIC NRC06F2492TRF
19	1	R40	RES., CHIP, 11k, 1%, 0603	NIC NRC06F127TRF
20	2	R43, R78	RES., CHIP, 5.76k, 1%, 0603	NIC NRC06F5761TRF
21	3	R120, R121, R122	RES., CHIP, 4.99k, 1%, 0603	NIC NRC06F4991TRF
22	1	R76	RES., CHIP, 12.7k, 1%, 0603	VISHAY CRCW060311K0FKEA
23	2	R100, R101	RES., CHIP, 200Ω, 1%, 0603	NIC NRC06F2000TRF
24	2	R103, R111	RES., CHIP, 0.02Ω, 1%, 2010	VISHAY, WSL2010R020FEA
25	1	R104	RES., CHIP, 127Ω, 1%, 0603	NIC NRC06F1270TRF
26	2	R105, R107	RES., CHIP, 100k, 1%, 0603	NIC NC06F1003TRF
27	1	R106	RES., CHIP, 49.9Ω, 1%, 0603	NIC NRC06F49R9TRF
28	2	R113, R114	RES., CHIP, 10Ω, 1%, 0603	NIC NRC06F10r0TRF
29	3	R9, R85, R86	RES., CHIP, 0Ω, 0603	PANASONIC ERJ-3GEY0R00V
30	0	R12, R19 OPT		
31	4	R84, R74, R80, R83	RES., CHIP, 0Ω, 2010	TEPRO(NAKOMA) RN6083
32	0	R15 OPT	RES., 0603	
33	1	R17	RES., CHIP, 4.87k, 1%, 0603	NIC NRC06F4871TRF
34	1	C16	CAP., X5R, 4.7nF, 25V, 10%, 0603	NIC NMC0603X7R472K50TRPF
35	0	C17, OPT		
36	0	C74, C80-C86 OPT	CAP., 1210	
37	0	Q12, Q13, Q14, Q16 OPT	MOSFET SPEED SRS LPAK	
38	1	R42	RES., CHIP, 5.76k, 1%, 0603	NIC NRC06F5761TRF
39	1		FAB, PRINTED CIRCUIT BOARD	DEMO CIRCUIT 1740A
40	1	R44	RES., CHIP, 0Ω, 0603	PANASONIC ERJ-3GEY0R00V

Hardware—DC1740A-A

1	4	JP2-JP5	0.1" SINGLE ROW HEADER, 3 PIN	SAMTEC, TSW-103-07-L-S
2	2	JP2-JP5	SHUNT, 0.1" BLK	SAMTEC SNT-100-BK-G
3	4	J1, J2, J9, J11	JACK, BANANA	KEYSTONE 575-4
4	2	J3, J4	STUD, TESTPIN	PEM KFH-032-10
5	4	J3, J4 (X2)	NUT, BRASS 10-32	ANY #10-32
6	2	J3, J4	RING, LUG #10	KEYSTONE #10
7	2	J3, J4	WASHER, TIN PLATED BRASS	ANY #10
8	2	J5, J6	CONN, BNC, 5PINS	CONNEX, 112404
9	1	J7	CONN SOCKET 20 DUAL ROW RA (F)	MILL MAX 803-43-020-20-001
10	1	J8	PIN HEADER 20 DUAL ROW RA (M)	MILL MAX 802-43-020-20-001
11	1	J10	CONN HEADER 12POS 2MM STR DL PCB	FCI 98414-G06-12ULF
12	1	U4	IC, LDO REG W/SHTDWN 3.3V 8-SOIC	ANALOG DEVICES, LT1129CS8-3.3
13	1	U5	IC, LT1129CS8-5, S8 PACKAGE	ANALOG DEVICES, LT1129CS8-5

PARTS LIST

ITEM	QTY	REFERENCE	PART DESCRIPTION	MANUFACTURE/PART NUMBER
14	1	U6	IC, SERIAL EEPROM	MICROCHIP 24LC025-I/ST
15	2	SW3,SW4	CONNECTOR, SUB MINIATURE SLIDE SWITCHES	C&K.,JS202011CQN
16	28	TP2-TP16, TP19-TP28, TP30, TP40, TP42	TESTPOINT, TURRET, 0.062"	MILL-MAX, 2308-2-00-80-00-00-07-0
17	4	STAND-OFF	STAND-OFF, NYLON 0.50" tall	KEYSTONE, 8833(SNAP ON)

Required Circuit Components—DC1740A-B

1	2	C1, C36	CAP., X5R, 4.7μF,16V, 10%, 0805	MURATA GRM219R61C475KE15D
2	1	C76	CAP., X5R, 4.7μF,16V, 10%, 0603	TDK C1608X5R1C475K
3	6	C2, C40, C20, C34, C53, C67	CAP., X5R, 0.22μF,16V, 10%, 0603	AVX 0603YD224KAT2A
4	2	C72, C78	CAP., X5R, 0.22μF,16V, 10%, 0805	AVX 0805YC224KAT2A
5	2	C3, C69	CAP., OS-CON, 150μF, 16V, 20%, F12	SANYO, 16SVP150M
6	3	C5, C22, C37	CAP., X5R, 10μF,16V, 10%, 1210	TAIYO YUDEN EMK325BJ106KN
7	1	C58	CAP., X5R, 10μF,16V, 10%, 1210	TAIYO YUDEN EMK325BJ106KN
8	1	C75	CAP., X5R, 10μF,16V, 10%, 1206	TAIYO YUDEN EMK316BJ106KD
9	5	C6, C26, C39, C59, C79	CAP., X5R, 100nF,25V, 10%, 0603	AVX 06033C104KAT2A
10	4	C7, C8, C41, C42	CAP., X5R, 1μF, 25V, 10%, 0603	AVX 06033D105KAT2A
11	2	C73, C77	CAP., X5R, 1μF, 16V, 10%, 1206	AVX 1206YD105KAT2A
12	16	C9, C10, C14, C15, C27, C28, C29, C30, C46, C47, C48, C49, C60, C61, C62, C63	CAP., POSCAP 330μF 4V D3L	SANYO, 4TPF330M9L
13	12	C11, C12, C13, C31, C32, C33, C43, C44, C45, C64, C65, C66	CAP., X5R, 100μF, 6.3V, 10%,1210	AVX 12106D107AT2A
14	1	C50	CAP., X7R, 4.7nF, 50V, 10%, 0603	NIC NMC0603X7R472K50TRPF
15	4	C18, C19, C51, C52	CAP., X7R, 100pF, 25V, 10%, 0603	AVX 06033C101JAT2A
16	4	C21, C35, C54, C68	CAP., X5R, 1μF, 25V, 10%, 0603	AVX 06033D105KAT2A
17	6	C23, C25, C56, C57, C70, C71	CAP., X5R, 10nF,16V, 10%, 0603	AVX 0603YC103KAT2A
18	4	D1, D2, D3, D4	DIODE, SCHOTTKY, SOD-323	CENTRAL CMDSH-3TR
19	4	L1, L2, L3, L4	INDUCTOR, SMT POWER IND. 0.4uH	COILCRAFT, XAL1060-401
20	4	Q1-Q4	DUAL N-CHANNEL MOSFET 25V LPAK	FAIRCHILD FDMS3620S
21	1	U1	IC, LTC3880EUJ, QFN 6mm x 6mm	ANALOG DEVICES, LTC3880EUJ#PBF
22	1	U2	IC, LTC3880EUJ, QFN 6mm x 6mm	ANALOG DEVICES, LTC3880EUJ#PBF

Additional Circuit Components—DC1740A-B

1	2	D5, D6	LED GREEN S-GW TYPE SMD	PANASONIC LN1371SGTRP
2	1	D7	LED RED S-TYPE GULL WING SMD	PANASONIC LN1271RTR
3	0	Q7, Q9, Q10, Q11, Q12, Q13, Q14, Q16 (OPT)	MOSFET SPEED SRS 30V 30A LPAK	
4	4	Q5, Q8, Q15, Q18	TRANS GP SS PNP 40V SOT-23	ON SEMI, MMBT3906LT1G
5	1	Q21	N-CHANNEL 30-V MOSFET,TO-252	VISHAY, SUD50N03-10P-E3
6	3	Q22, Q25, Q26	MOSFET P-CH 20V 0.58A SOT-23	VISHAY TP0101K-T1-E3
7	2	Q23, Q24	MOSFET N-CH 60V 115MA SOT-23	FAIRCHILD 2N7002A
8	0	R1, R46, R126, R128 (OPT)	RES., 0805	
9	0	R11, R14, R24, R26, R28, R36, R37, R53, R54, R63, R65, R71, R73, R94, R117, R118, R124, R127, R129(OPT)	RES., 0603	

DEMO MANUAL DC1740A

PARTS LIST

ITEM	QTY	REFERENCE	PART DESCRIPTION	MANUFACTURE/PART NUMBER
10	29	R2, R3, R10, R16, R20, R22, R25, R27, R30, R45, R47, R48, R50, R52, R55, R58, R59, R61, R64, R66, R67, R68, R75, R89, R90, R95, R129, R77, R79	RES., CHIP, 0Ω, 0603	NIC NRC06ZOTRF
11	5	R109, R115, R116, R119	RES., CHIP, 0Ω, 0805	NIC NRC10ZOTRF
12	1	R41	RES., CHIP, 15k, 1%, 0603	NIC NRC06F1502TRF
13	4	R4, R21, R49, R60	RES., CHIP, 0Ω, 2010	TEPRO(NAKOMA) RN6083
14	16	R5, R6, R7, R8, R29, R38, R39, R81, R82, R87, R88, R91, R96, R102, R110, R112	RES., CHIP, 10k, 1%, 0603	NIC NRC06f1002TRF
15	8	R13, R18, R23, R31, R51, R57, R62, R69	RES., CHIP, 1k, 1%, 0603	NIC NRC06F1001TRF
16	2	R56	RES., CHIP, 4.87k, 1%, 0603	NIC NRC06F4871TRF
17	3	R33, R32, R70	RES., CHIP, 20k, 1%, 0603	NIC NRC06F2002TRF
18	3	R34, R35, R72	RES., CHIP, 24.9k, 1%, 0603	NIC NRC06F2492TRF
19	1	R40	RES., CHIP, 11k, 1%, 0603	NIC NRC06F127TRF
20	2	R43, R78	RES., CHIP, 5.76k, 1%, 0603	NIC NRC06F5761TRF
21	3	R120, R121, R122	RES., CHIP, 4.99k, 1%, 0603	NIC NRC06F4991TRF
22	1	R76	RES., CHIP, 12.7k, 1%, 0603	Vishay CRCW060311K0FKEA
23	2	R100, R101	RES., CHIP, 200Ω, 1%, 0603	NIC NRC06F2000TRF
24	2	R103, R111	RES., CHIP, 0.02Ω, 1%, 2010	VISHAY, WSL2010R020FEA
25	1	R104	RES., CHIP, 127Ω, 1%, 0603	NIC NRC06F1270TRF
26	2	R105, R107	RES., CHIP, 100k, 1%, 0603	NIC NC06F1003TRF
27	1	R106	RES., CHIP, 49.9Ω, 1%, 0603	NIC NRC06F49R9TRF
28	2	R113, R114	RES., CHIP, 10Ω, 1%, 0603	NIC NRC06F10r0TRF
29	0	R9, R85, R86 OPT	RES., 0603	
30	2	R12, R19	RES., CHIP, 0Ω, 0603	PANASONIC ERJ-3GEY0R00V
31	0	R84, R74, R80, R83 OPT	RES., CHIP, 2010	TEPRO(NAKOMA) RN6083
32	0	R15, OPT		
33	1	R17	RES., CHIP, 10k, 1%, 0603	NIC NRC06F4871TRF
34	1	C16	CAP., X5R, 10nF, 25V, 10%, 0603	MURATA GRM18BR71E103KA37D
35	0	C17, OPT		
36	0	C74, C80-C86 OPT	CAP., 1210	
37	0	Q12, Q13, Q14, Q16 OPT	MOSFET SPEED SRS LPAK	
38	1	R42	RES., CHIP, 7.32k, 1%, 0603	VISHAY, CRCW060311K3FKEA
39	1		FAB, PRINTED CIRCUIT BOARD	DEMO CIRCUIT 1740A
40	0	R44, OPT		

PARTS LIST

ITEM	QTY	REFERENCE	PART DESCRIPTION	MANUFACTURE/PART NUMBER
Hardware—DC1740A-B				
1	4	JP2-JP5	0.1" SINGLE ROW HEADER, 3 PIN	SAMTEC, TSW-103-07-L-S
2	2	JP2-JP5	SHUNT, 0.1" BLK	SAMTEC SNT-100-BK-G
3	4	J1, J2, J9, J11	JACK, BANANA	KEYSTONE 575-4
4	2	J3, J4	STUD, TESTPIN	PEM KFH-032-10
5	4	J3, J4 (X2)	NUT, BRASS 10-32	ANY #10-32
6	2	J3, J4	RING, LUG #10	KEYSTONE #10
7	2	J3, J4	WASHER, TIN PLATED BRASS	ANY #10
8	2	J5, J6	CONN, BNC, 5PINS	CONNEX, 112404
9	1	J7	CONN SOCKET 20 DUAL ROW RA (F)	MILL MAX 803-43-020-20-001
10	1	J8	PIN HEADER 20 DUAL ROW RA (M)	MILL MAX 802-43-020-20-001
11	1	J10	CONN HEADER 12POS 2MM STR DL PCB	FCI 98414-G06-12ULF
12	1	U4	IC, LDO REG W/SHTDWN 3.3V 8-SOIC	ANALOG DEVICES, LT1129CS8-3.3
13	1	U5	IC, LT1129CS8-5, S8 PACKAGE	ANALOG DEVICES, LT1129CS8-5
14	1	U6	IC, SERIAL EEPROM	MICROCHIP 24LC025-I/ST
15	2	SW3, SW4	CONNECTOR, SUB MINIATURE SLIDE SWITCHES	C&K., JS202011CQN
16	28	TP2-TP16, TP19-TP28, TP30, TP40, TP42	TESTPOINT, TURRET, 0.062"	MILL-MAX, 2308-2-00-80-00-00-07-0
17	4	STAND-OFF	STAND-OFF, NYLON 0.50" tall	KEYSTONE, 8833(SNAP ON)

DEMO MANUAL DC1740A

SCHEMATIC DIAGRAM

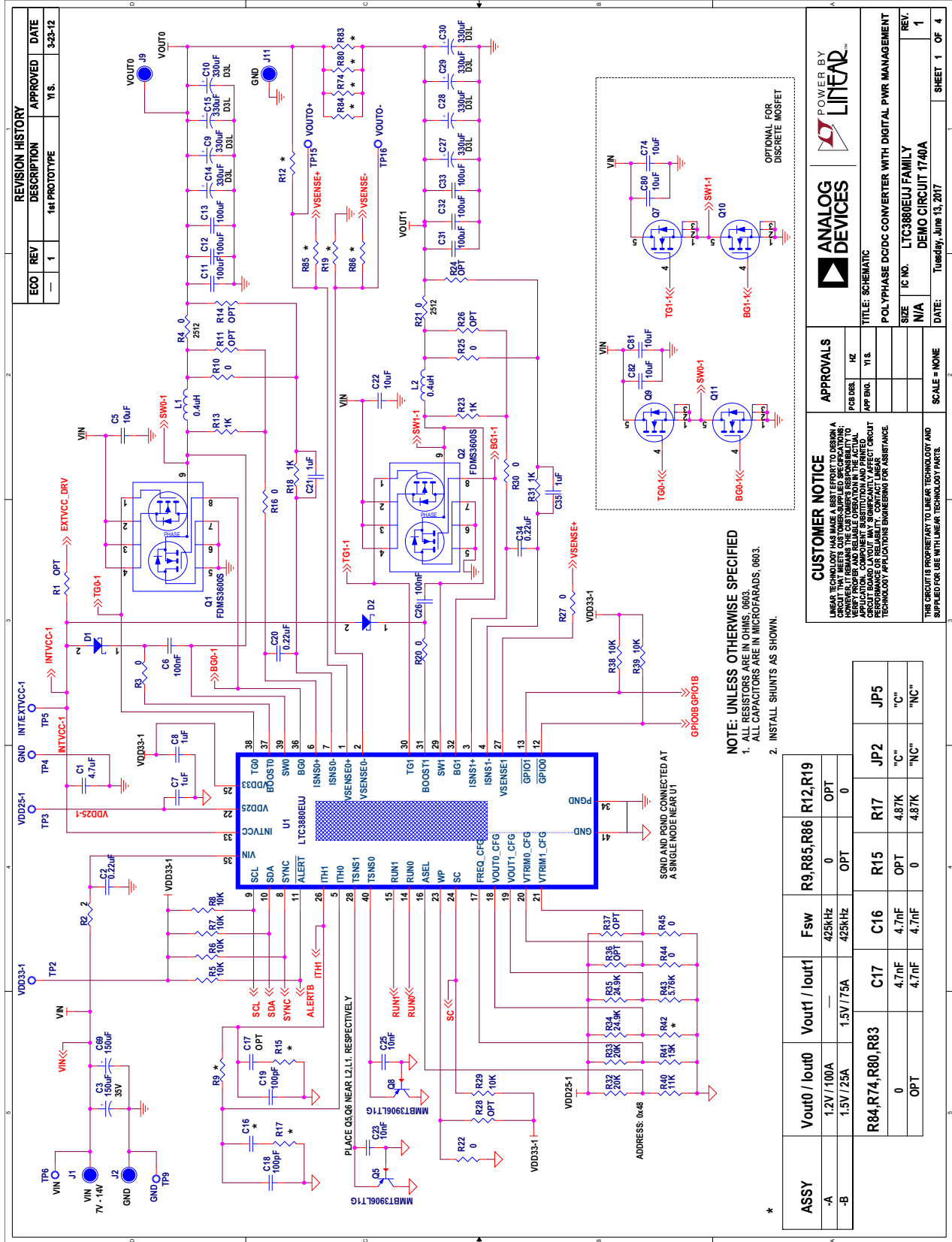

SCHEMATIC DIAGRAM

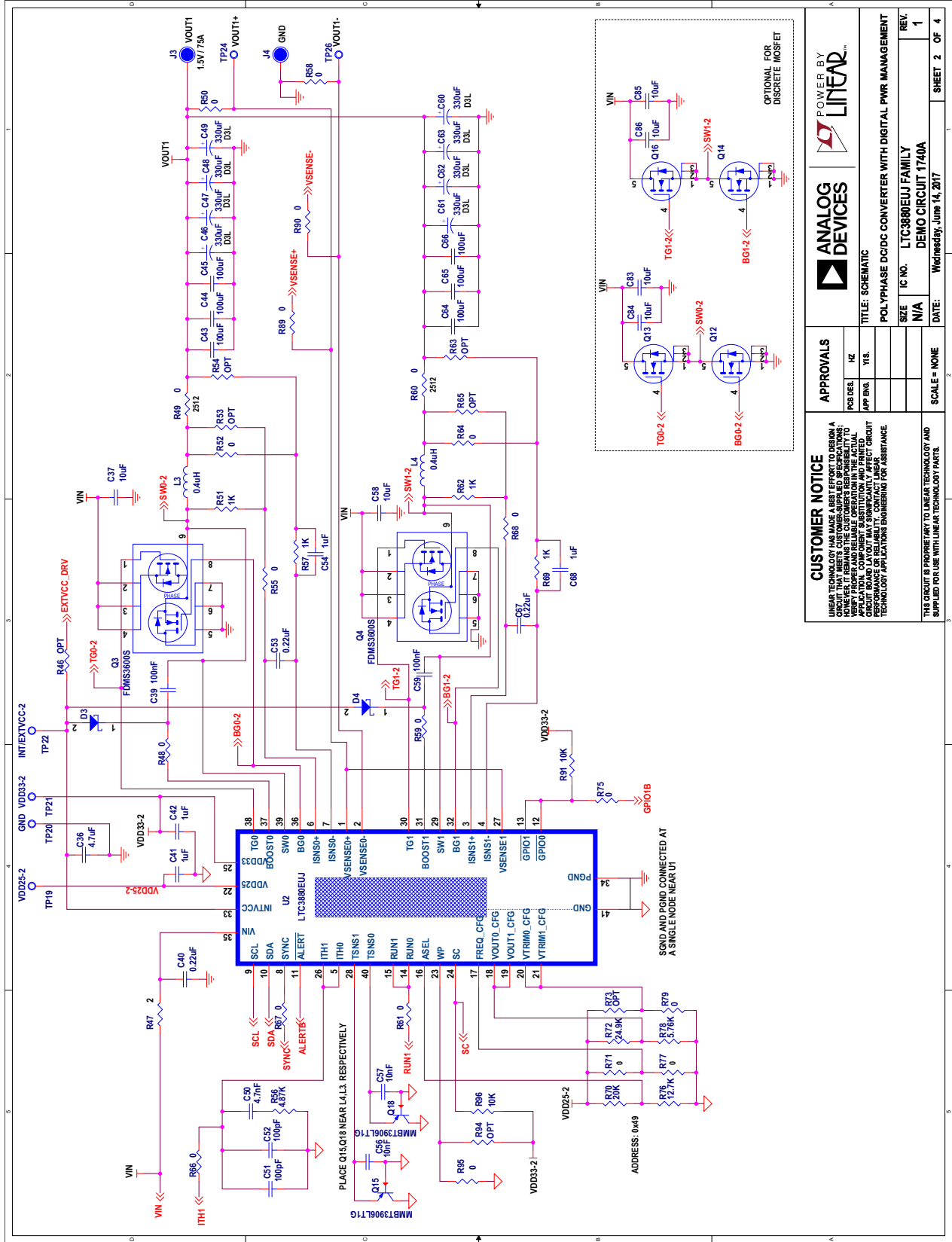

APPROVALS		ANALOG DEVICES		POWER BY LINEAR™	
DESIGN	YES	IC NO.	LTC3890EUJ FAMILY	TITLE:	SCHEMATIC
APP'G	YES	SIZE	POLYPHASE DC/DC CONVERTER WITH DIGITAL PWR. MANAGEMENT	IC NO.	LTC3890EUJ FAMILY
SCALE	NONE	DATE:	Wednesday, June 14, 2017	REV.	1
				SHEET	2 OF 4

CUSTOMER NOTICE

LINEAR TECHNOLOGY HAS MADE A BEST EFFORT TO DESIGN A DEMO CIRCUIT FOR THE CUSTOMER'S REFERENCE. HOWEVER, IT REMAINS THE CUSTOMER'S RESPONSIBILITY TO DESIGN AND VERIFY THE CIRCUIT FOR THEIR APPLICATION. LINEAR TECHNOLOGY DOES NOT WARRANT ANY PERFORMANCE OR RELIABILITY OF THE CIRCUIT BOARD LAYOUT MAY SIGNIFICANTLY AFFECT CIRCUIT PERFORMANCE. CUSTOMERS SHOULD CONSULT WITH LINEAR TECHNOLOGY APPLICATIONS ENGINEERING FOR ASSISTANCE.

THIS CIRCUIT IS PROPRIETARY TO LINEAR TECHNOLOGY AND NOT FOR USE WITH LINEAR TECHNOLOGY PARTS.

DEMO MANUAL DC1740A

SCHEMATIC DIAGRAM

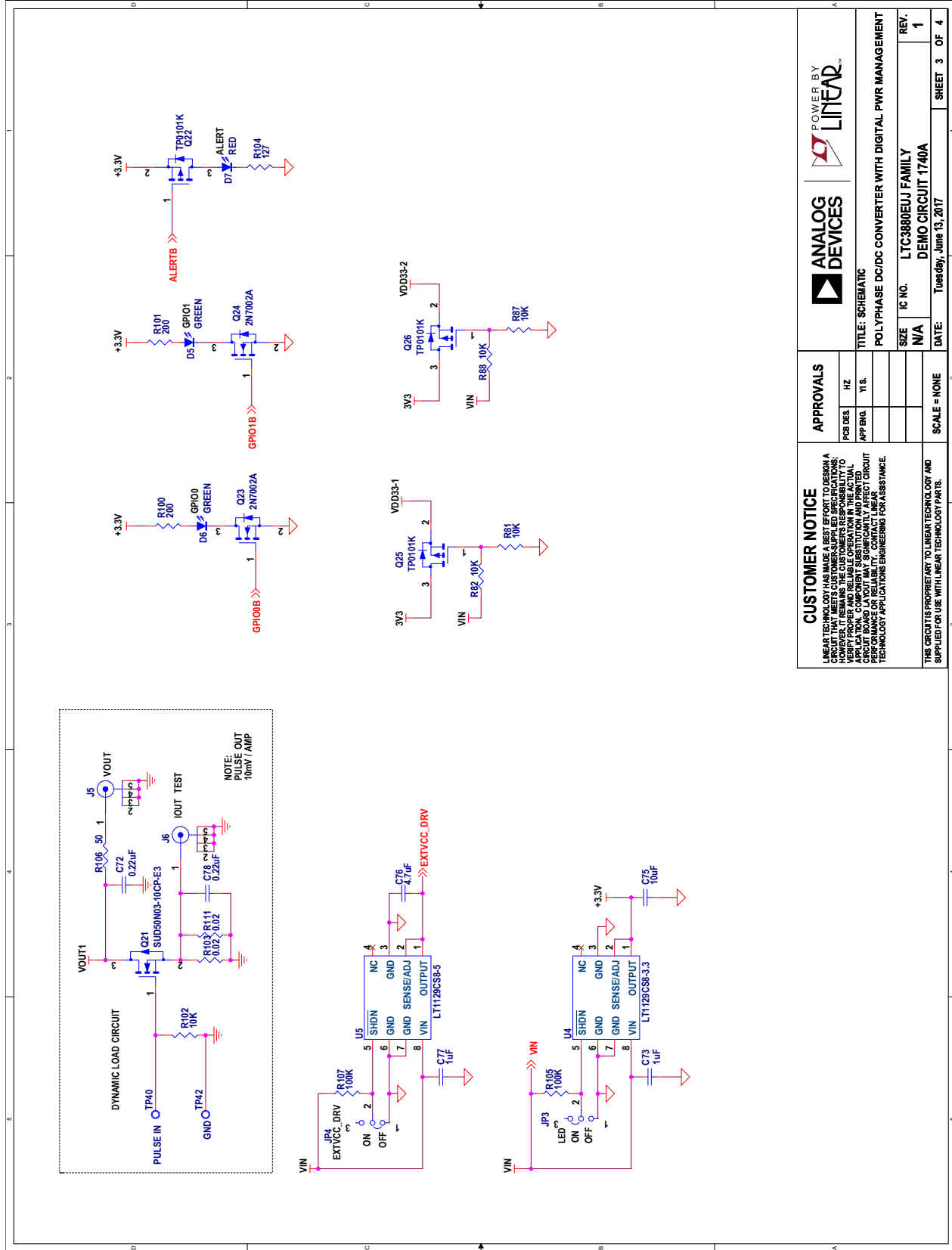

SCHEMATIC DIAGRAM

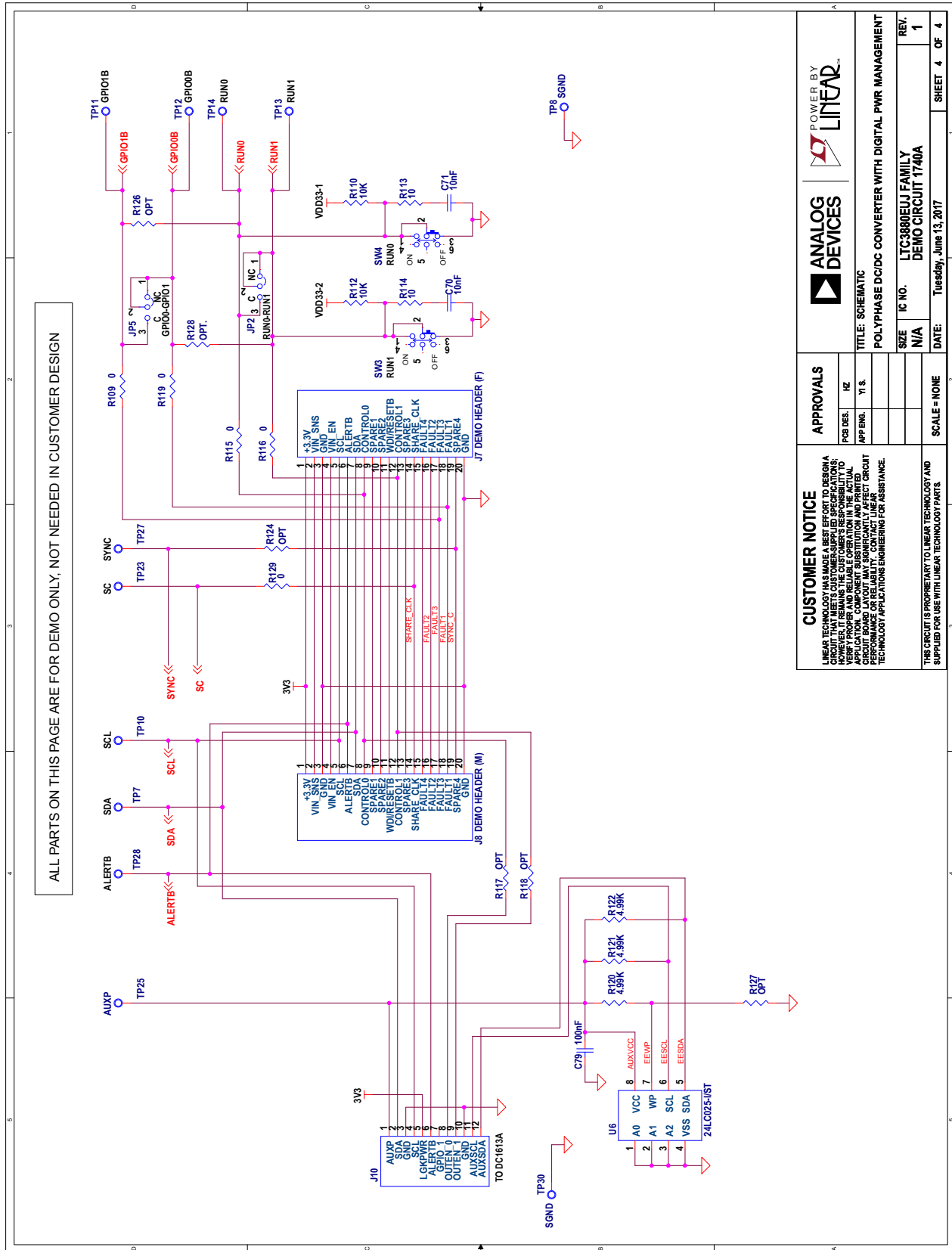

APPROVALS		POWER BY	
PCB DES.	HZ	ANALOG DEVICES	LINTEAD
APP'NG.	Y1 S.	TITLE: SCHEMATIC	
POLYPHASE DC/DC CONVERTER WITH DIGITAL PWR MANAGEMENT		SIZE	REV.
		N/A	1
		DATE: Tuesday, June 13, 2017	SHEET 4 OF 4

CUSTOMER NOTICE

LINEAR TECHNOLOGY HAS MADE A BEST EFFORT TO DESIGN AND VERIFY THIS SCHEMATIC FOR PROPER OPERATION. HOWEVER, IT REMAINS THE CUSTOMER'S RESPONSIBILITY TO VERIFY PROPER AND RELIABLE OPERATION IN THE ACTUAL APPLICATION. CUSTOMER LAYOUTS, BOARD LAYOUTS, PERFORMANCE OR RELIABILITY MAY SIGNIFICANTLY AFFECT CIRCUIT PERFORMANCE. CONTACT LINEAR TECHNOLOGY APPLICATIONS ENGINEERING FOR ASSISTANCE.

THIS CIRCUIT IS PROPRIETARY TO LINEAR TECHNOLOGY AND SUPPLIED FOR USE WITH LINEAR TECHNOLOGY PARTS.



ESD Caution

ESD (electrostatic discharge) sensitive device. Charged devices and circuit boards can discharge without detection. Although this product features patented or proprietary protection circuitry, damage may occur on devices subjected to high energy ESD. Therefore, proper ESD precautions should be taken to avoid performance degradation or loss of functionality.

Legal Terms and Conditions

By using the evaluation board discussed herein (together with any tools, components documentation or support materials, the "Evaluation Board"), you are agreeing to be bound by the terms and conditions set forth below ("Agreement") unless you have purchased the Evaluation Board, in which case the Analog Devices Standard Terms and Conditions of Sale shall govern. Do not use the Evaluation Board until you have read and agreed to the Agreement. Your use of the Evaluation Board shall signify your acceptance of the Agreement. This Agreement is made by and between you ("Customer") and Analog Devices, Inc. ("ADI"), with its principal place of business at One Technology Way, Norwood, MA 02062, USA. Subject to the terms and conditions of the Agreement, ADI hereby grants to Customer a free, limited, personal, temporary, non-exclusive, non-sublicensable, non-transferable license to use the Evaluation Board FOR EVALUATION PURPOSES ONLY. Customer understands and agrees that the Evaluation Board is provided for the sole and exclusive purpose referenced above, and agrees not to use the Evaluation Board for any other purpose. Furthermore, the license granted is expressly made subject to the following additional limitations: Customer shall not (i) rent, lease, display, sell, transfer, assign, sublicense, or distribute the Evaluation Board; and (ii) permit any Third Party to access the Evaluation Board. As used herein, the term "Third Party" includes any entity other than ADI, Customer, their employees, affiliates and in-house consultants. The Evaluation Board is NOT sold to Customer; all rights not expressly granted herein, including ownership of the Evaluation Board, are reserved by ADI. CONFIDENTIALITY. This Agreement and the Evaluation Board shall all be considered the confidential and proprietary information of ADI. Customer may not disclose or transfer any portion of the Evaluation Board to any other party for any reason. Upon discontinuation of use of the Evaluation Board or termination of this Agreement, Customer agrees to promptly return the Evaluation Board to ADI. ADDITIONAL RESTRICTIONS. Customer may not disassemble, decompile or reverse engineer chips on the Evaluation Board. Customer shall inform ADI of any occurred damages or any modifications or alterations it makes to the Evaluation Board, including but not limited to soldering or any other activity that affects the material content of the Evaluation Board. Modifications to the Evaluation Board must comply with applicable law, including but not limited to the RoHS Directive. TERMINATION. ADI may terminate this Agreement at any time upon giving written notice to Customer. Customer agrees to return to ADI the Evaluation Board at that time. LIMITATION OF LIABILITY. THE EVALUATION BOARD PROVIDED HEREUNDER IS PROVIDED "AS IS" AND ADI MAKES NO WARRANTIES OR REPRESENTATIONS OF ANY KIND WITH RESPECT TO IT. ADI SPECIFICALLY DISCLAIMS ANY REPRESENTATIONS, ENDORSEMENTS, GUARANTEES, OR WARRANTIES, EXPRESS OR IMPLIED, RELATED TO THE EVALUATION BOARD INCLUDING, BUT NOT LIMITED TO, THE IMPLIED WARRANTY OF MERCHANTABILITY, TITLE, FITNESS FOR A PARTICULAR PURPOSE OR NON-INFRINGEMENT OF INTELLECTUAL PROPERTY RIGHTS. IN NO EVENT WILL ADI AND ITS LICENSORS BE LIABLE FOR ANY INCIDENTAL, SPECIAL, INDIRECT, OR CONSEQUENTIAL DAMAGES RESULTING FROM CUSTOMER'S POSSESSION OR USE OF THE EVALUATION BOARD, INCLUDING BUT NOT LIMITED TO LOST PROFITS, DELAY COSTS, LABOR COSTS OR LOSS OF GOODWILL. ADI'S TOTAL LIABILITY FROM ANY AND ALL CAUSES SHALL BE LIMITED TO THE AMOUNT OF ONE HUNDRED US DOLLARS (\$100.00). EXPORT. Customer agrees that it will not directly or indirectly export the Evaluation Board to another country, and that it will comply with all applicable United States federal laws and regulations relating to exports. GOVERNING LAW. This Agreement shall be governed by and construed in accordance with the substantive laws of the Commonwealth of Massachusetts (excluding conflict of law rules). Any legal action regarding this Agreement will be heard in the state or federal courts having jurisdiction in Suffolk County, Massachusetts, and Customer hereby submits to the personal jurisdiction and venue of such courts. The United Nations Convention on Contracts for the International Sale of Goods shall not apply to this Agreement and is expressly disclaimed.