

LOW POWER SIX-CHANNEL DIGITAL ISOLATOR

Features

- High-speed operation
 - DC to 150 Mbps
- No start-up initialization required
- Wide Operating Supply Voltage: 2.70–5.5 V
- Wide Operating Supply Voltage: 2.70–5.5V
- Ultra low power (typical) 5 V Operation:
 - < 1.6 mA per channel at 1 Mbps
 - < 6 mA per channel at 100 Mbps
- 2.70 V Operation:
 - < 1.4 mA per channel at 1 Mbps
 - < 4 mA per channel at 100 Mbps
- High electromagnetic immunity
- Up to 2500 V_{RMS} isolation
- 60-year life at rated working voltage
- Precise timing (typical)
 - <10 ns worst case
 - 1.5 ns pulse width distortion
 - 0.5 ns channel-channel skew
 - 2 ns propagation delay skew
 - 6 ns minimum pulse width
- Transient Immunity 25 kV/μs
- Wide temperature range
 - –40 to 125 °C at 150 Mbps
- RoHS-compliant packages
 - SOIC-16 narrow body



Applications

- Industrial automation systems
- Hybrid electric vehicles
- Isolated switch mode supplies
- Isolated ADC, DAC
- Motor control
- Power inverters
- Communications systems

Safety Regulatory Approvals

- UL 1577 recognized
 - Up to 2500 V_{RMS} for 1 minute
- CSA component notice 5A approval
 - IEC 60950-1, 61010-1 (reinforced insulation)
- VDE certification conformity
 - IEC 60747-5-2 (VDE0884 Part 2)

Description

Silicon Lab's family of ultra-low-power digital isolators are CMOS devices offering substantial data rate, propagation delay, power, size, reliability, and external BOM advantages when compared to legacy isolation technologies. The operating parameters of these products remain stable across wide temperature ranges throughout their service life. For ease of design, only VDD bypass capacitors are required.

Data rates up to 150 Mbps are supported, and all devices achieve worst-case propagation delays of less than 10 ns. All products are safety certified by UL, CSA, and VDE and support withstand voltages of up to 2.5 kVrms. These devices are available in a 16-pin narrow-body SOIC package.

TABLE OF CONTENTS

| <u>Section</u> | <u>Page</u> |
|---|--------------------|
| 1. Electrical Specifications | 3 |
| 2. Functional Description | 19 |
| 2.1. Theory of Operation | 19 |
| 2.2. Eye Diagram | 20 |
| 2.3. Device Operation | 21 |
| 2.4. Layout Recommendations | 22 |
| 2.5. Typical Performance Characteristics | 23 |
| 3. Errata and Design Migration Guidelines | 26 |
| 3.1. Power Supply Bypass Capacitors (Revision A and Revision B) | 26 |
| 3.2. Latch Up Immunity (Revision A Only) | 26 |
| 4. Pin Descriptions | 27 |
| 5. Ordering Guide | 28 |
| 6. Package Outline: 16-Pin Narrow Body SOIC | 30 |
| 7. Land Pattern: 16-Pin Narrow Body SOIC | 32 |
| 8. Top Marking: 16-Pin Narrow Body SOIC | 33 |
| 8.1. 16-Pin Narrow Body SOIC Top Marking | 33 |
| 8.2. Top Marking Explanation | 33 |
| Document Change List | 34 |

Not Recommended
for New Designs

1. Electrical Specifications

Table 1. Recommended Operating Conditions

| Parameter | Symbol | Test Condition | Min | Typ | Max | Unit |
|--------------------------------|-----------|----------------------|------|-----|-----|------|
| Ambient Operating Temperature* | T_A | 150 Mbps, 15 pF, 5 V | -40 | 25 | 125 | °C |
| Supply Voltage | V_{DD1} | | 2.70 | — | 5.5 | V |
| | V_{DD2} | | 2.70 | — | 5.5 | V |

***Note:** The maximum ambient temperature is dependent on data frequency, output loading, number of operating channels, and supply voltage.

Table 2. Absolute Maximum Ratings¹

| Parameter | Symbol | Min | Typ | Max | Unit |
|--|--------------------|------|-----|----------------|-----------|
| Storage Temperature ² | T_{STG} | -65 | — | 150 | °C |
| Ambient Temperature Under Bias | T_A | -40 | — | 125 | °C |
| Supply Voltage (Revision A) ³ | V_{DD1}, V_{DD2} | -0.5 | — | 5.75 | V |
| Supply Voltage (Revision B) ³ | V_{DD1}, V_{DD2} | -0.5 | — | 6.0 | V |
| Input Voltage | V_I | -0.5 | — | $V_{DD} + 0.5$ | V |
| Output Voltage | V_O | -0.5 | — | $V_{DD} + 0.5$ | V |
| Output Current Drive Channel | I_O | — | — | 10 | mA |
| Lead Solder Temperature (10 s) | | — | — | 260 | °C |
| Maximum Isolation Voltage (1 s) | | — | — | 3600 | V_{RMS} |

Notes:

1. Permanent device damage may occur if the absolute maximum ratings are exceeded. Functional operation should be restricted to conditions as specified in the operational sections of this data sheet.
2. VDE certifies storage temperature from -40 to 150 °C.
3. See "5. Ordering Guide" on page 28 for more information.

Si8460/61/62/63

Table 3. Electrical Characteristics

($V_{DD1} = 5 V \pm 10\%$, $V_{DD2} = 5 V \pm 10\%$, $T_A = -40$ to 125 °C; applies to narrow-body SOIC package)

| Parameter | Symbol | Test Condition | Min | Typ | Max | Unit |
|---|----------|-----------------|--------------------------|-----|------|------|
| High Level Input Voltage | V_{IH} | | 2.0 | — | — | V |
| Low Level Input Voltage | V_{IL} | | — | — | 0.8 | V |
| High Level Output Voltage | V_{OH} | loh = -4 mA | $V_{DD1}, V_{DD2} - 0.4$ | 4.8 | — | V |
| Low Level Output Voltage | V_{OL} | lol = 4 mA | — | 0.2 | 0.4 | V |
| Input Leakage Current | I_L | | — | — | ±10 | µA |
| Output Impedance ¹ | Z_O | | — | 85 | — | Ω |
| DC Supply Current (All inputs 0 V or at Supply) | | | | | | |
| Si8460Ax, Bx | | | | | | |
| V_{DD1} | | All inputs 0 DC | — | 1.7 | 2.6 | mA |
| V_{DD2} | | All inputs 0 DC | — | 3.3 | 5.0 | |
| V_{DD1} | | All inputs 1 DC | — | 7.7 | 11.6 | |
| V_{DD2} | | All inputs 1 DC | — | 3.5 | 5.3 | |
| Si8461Ax, Bx | | | | | | |
| V_{DD1} | | All inputs 0 DC | — | 2.1 | 3.2 | mA |
| V_{DD2} | | All inputs 0 DC | — | 3.4 | 5.1 | |
| V_{DD1} | | All inputs 1 DC | — | 7.1 | 10.7 | |
| V_{DD2} | | All inputs 1 DC | — | 4.5 | 6.8 | |
| Si8462Ax, Bx | | | | | | |
| V_{DD1} | | All inputs 0 DC | — | 2.5 | 3.8 | mA |
| V_{DD2} | | All inputs 0 DC | — | 3.0 | 4.5 | |
| V_{DD1} | | All inputs 1 DC | — | 6.5 | 9.8 | |
| V_{DD2} | | All inputs 1 DC | — | 5.0 | 8.3 | |
| Si8463Ax, Bx | | | | | | |
| V_{DD1} | | All inputs 0 DC | — | 2.8 | 4.2 | mA |
| V_{DD2} | | All inputs 0 DC | — | 2.8 | 4.2 | |
| V_{DD1} | | All inputs 1 DC | — | 6.0 | 9.0 | |
| V_{DD2} | | All inputs 1 DC | — | 6.0 | 9.0 | |
| Notes: | | | | | | |
| <ol style="list-style-type: none"> 1. The nominal output impedance of an isolator driver channel is approximately 85 Ω, ±40%, which is a combination of the value of the on-chip series termination resistor and channel resistance of the output driver FET. When driving loads where transmission line effects will be a factor, output pins should be appropriately terminated with controlled impedance PCB traces. 2. $t_{PSK(P-P)}$ is the magnitude of the difference in propagation delay times measured between different units operating at the same supply voltages, load, and ambient temperature. 3. Start-up time is the time period from the application of power to valid data at the output. | | | | | | |

Table 3. Electrical Characteristics (Continued)(V_{DD1} = 5 V±10%, V_{DD2} = 5 V±10%, T_A = -40 to 125 °C; applies to narrow-body SOIC package)

| Parameter | Symbol | Test Condition | Min | Typ | Max | Unit |
|--|--------|----------------|-----|-----|-----|------|
| 1 Mbps Supply Current (All inputs = 500 kHz square wave, CI = 15 pF on all outputs) | | | | | | |
| Si8460Ax, Bx | | | | | | |
| V _{DD1} | | | — | 4.7 | 7.1 | mA |
| V _{DD2} | | | — | 4.0 | 6.0 | |
| Si8461Ax, Bx | | | | | | |
| V _{DD1} | | | — | 4.7 | 7.1 | mA |
| V _{DD2} | | | — | 4.5 | 6.8 | |
| Si8462Ax, Bx | | | | | | |
| V _{DD1} | | | — | 4.7 | 7.1 | mA |
| V _{DD2} | | | — | 4.3 | 6.5 | |
| Si8463Ax, Bx | | | | | | |
| V _{DD1} | | | — | 4.7 | 7.1 | mA |
| V _{DD2} | | | — | 4.7 | 7.1 | |
| 10 Mbps Supply Current (All inputs = 5 MHz square wave, CI = 15 pF on all outputs) | | | | | | |
| Si8460Bx | | | | | | |
| V _{DD1} | | | — | 4.7 | 7.1 | mA |
| V _{DD2} | | | — | 5.5 | 7.7 | |
| Si8461Bx | | | | | | |
| V _{DD1} | | | — | 5.0 | 7.2 | mA |
| V _{DD2} | | | — | 5.7 | 8 | |
| Si8462Bx | | | | | | |
| V _{DD1} | | | — | 5.2 | 7.3 | mA |
| V _{DD2} | | | — | 5.4 | 7.6 | |
| Si8463Bx | | | | | | |
| V _{DD1} | | | — | 5.5 | 7.7 | mA |
| V _{DD2} | | | — | 5.5 | 7.7 | |
| Notes: | | | | | | |
| <ol style="list-style-type: none"> 1. The nominal output impedance of an isolator driver channel is approximately 85 Ω, ±40%, which is a combination of the value of the on-chip series termination resistor and channel resistance of the output driver FET. When driving loads where transmission line effects will be a factor, output pins should be appropriately terminated with controlled impedance PCB traces. 2. t_{PSK(P-P)} is the magnitude of the difference in propagation delay times measured between different units operating at the same supply voltages, load, and ambient temperature. 3. Start-up time is the time period from the application of power to valid data at the output. | | | | | | |

Si8460/61/62/63

Table 3. Electrical Characteristics (Continued)

($V_{DD1} = 5 V \pm 10\%$, $V_{DD2} = 5 V \pm 10\%$, $T_A = -40$ to 125 °C; applies to narrow-body SOIC package)

| Parameter | Symbol | Test Condition | Min | Typ | Max | Unit |
|--|-----------------------|----------------|-----|------|------|------|
| 100 Mbps Supply Current (All inputs = 50 MHz square wave, CI = 15 pF on all outputs) | | | | | | |
| Si8460Bx | | | | | | |
| V_{DD1} | | | — | 5.0 | 7.5 | mA |
| V_{DD2} | | | — | 28.8 | 36 | |
| Si8461Bx | | | | | | |
| V_{DD1} | | | — | 9.0 | 11.3 | mA |
| V_{DD2} | | | — | 25 | 30 | |
| Si8462Bx | | | | | | |
| V_{DD1} | | | — | 13.3 | 16.6 | mA |
| V_{DD2} | | | — | 20.8 | 26 | |
| Si8463Bx | | | | | | |
| V_{DD1} | | | — | 17.2 | 21.5 | mA |
| V_{DD2} | | | — | 17.2 | 21.5 | |
| Timing Characteristics | | | | | | |
| Si846xAx | | | | | | |
| Maximum Data Rate | | | 0 | — | 1.0 | Mbps |
| Minimum Pulse Width | | | — | — | 250 | ns |
| Propagation Delay | t_{PHL} , t_{PLH} | See Figure 1 | — | — | 35 | ns |
| Pulse Width Distortion $ t_{PLH} - t_{PHL} $ | PWD | See Figure 1 | — | — | 25 | ns |
| Propagation Delay Skew ² | $t_{PSK(P-P)}$ | | — | — | 40 | ns |
| Channel-Channel Skew | t_{PSK} | | — | — | 35 | ns |
| Si846xBx | | | | | | |
| Maximum Data Rate | | | 0 | — | 150 | Mbps |
| Minimum Pulse Width | | | — | — | 6.0 | ns |
| Propagation Delay | t_{PHL} , t_{PLH} | See Figure 1 | 3.0 | 6.0 | 9.5 | ns |
| Pulse Width Distortion $ t_{PLH} - t_{PHL} $ | PWD | See Figure 1 | — | 1.5 | 2.5 | ns |
| Propagation Delay Skew ² | $t_{PSK(P-P)}$ | | — | 2.0 | 3.0 | ns |
| Channel-Channel Skew | t_{PSK} | | — | 0.5 | 1.8 | ns |
| Notes: | | | | | | |
| <ol style="list-style-type: none"> 1. The nominal output impedance of an isolator driver channel is approximately 85Ω, $\pm 40\%$, which is a combination of the value of the on-chip series termination resistor and channel resistance of the output driver FET. When driving loads where transmission line effects will be a factor, output pins should be appropriately terminated with controlled impedance PCB traces. 2. $t_{PSK(P-P)}$ is the magnitude of the difference in propagation delay times measured between different units operating at the same supply voltages, load, and ambient temperature. 3. Start-up time is the time period from the application of power to valid data at the output. | | | | | | |

Table 3. Electrical Characteristics (Continued) $(V_{DD1} = 5 V \pm 10\%$, $V_{DD2} = 5 V \pm 10\%$, $T_A = -40$ to 125 °C; applies to narrow-body SOIC package)

| Parameter | Symbol | Test Condition | Min | Typ | Max | Unit |
|--------------------------------|----------|-------------------------------|-----|-----|-----|-------------|
| All Models | | | | | | |
| Output Rise Time | t_r | $C_L = 15$ pF See Figure 1 | — | 3.8 | 5.0 | ns |
| Output Fall Time | t_f | $C_L = 15$ pF See Figure 1 | — | 2.8 | 3.7 | ns |
| Common Mode Transient Immunity | CMTI | $V_I = V_{DD}$ or 0 V | — | 25 | — | kV/ μ s |
| Start-up Time ³ | t_{SU} | | — | 15 | 40 | μ s |

Notes:

1. The nominal output impedance of an isolator driver channel is approximately 85Ω , $\pm 40\%$, which is a combination of the value of the on-chip series termination resistor and channel resistance of the output driver FET. When driving loads where transmission line effects will be a factor, output pins should be appropriately terminated with controlled impedance PCB traces.
2. $t_{PSK(P-P)}$ is the magnitude of the difference in propagation delay times measured between different units operating at the same supply voltages, load, and ambient temperature.
3. Start-up time is the time period from the application of power to valid data at the output.

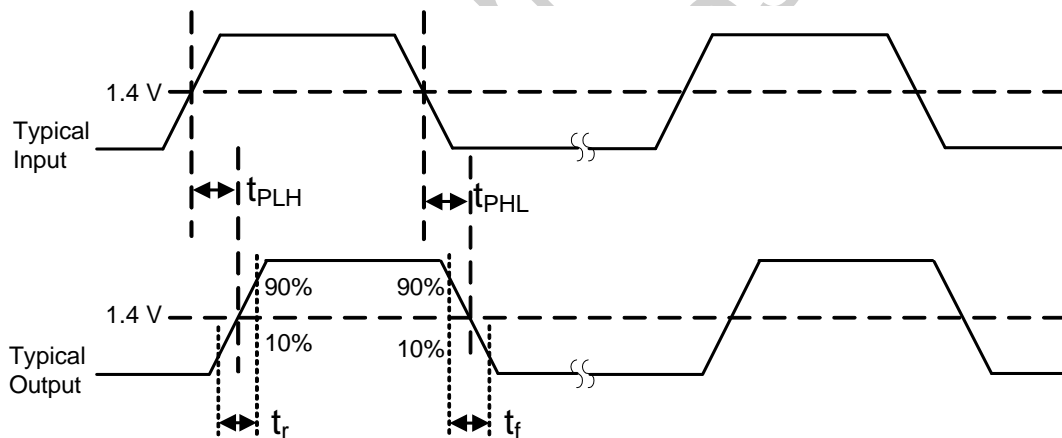
**Figure 1. Propagation Delay Timing**

Si8460/61/62/63

Table 4. Electrical Characteristics

($V_{DD1} = 3.3\text{ V} \pm 10\%$, $V_{DD2} = 3.3\text{ V} \pm 10\%$, $T_A = -40\text{ to }125\text{ }^\circ\text{C}$; applies to narrow-body SOIC package)

| Parameter | Symbol | Test Condition | Min | Typ | Max | Unit |
|---|----------|-----------------|--------------------------|-----|----------|---------------|
| High Level Input Voltage | V_{IH} | | 2.0 | — | — | V |
| Low Level Input Voltage | V_{IL} | | — | — | 0.8 | V |
| High Level Output Voltage | V_{OH} | loh = -4 mA | $V_{DD1}, V_{DD2} - 0.4$ | 3.1 | — | V |
| Low Level Output Voltage | V_{OL} | lol = 4 mA | — | 0.2 | 0.4 | V |
| Input Leakage Current | I_L | | — | — | ± 10 | μA |
| Output Impedance ¹ | Z_O | | — | 85 | — | Ω |
| DC Supply Current (All inputs 0 V or at supply) | | | | | | |
| Si8460Ax, Bx | | | | | | |
| V_{DD1} | | All inputs 0 DC | — | 1.7 | 2.6 | mA |
| V_{DD2} | | All inputs 0 DC | — | 3.3 | 5.0 | |
| V_{DD1} | | All inputs 1 DC | — | 7.7 | 11.6 | |
| V_{DD2} | | All inputs 1 DC | — | 3.5 | 5.3 | |
| Si8461Ax, Bx | | | | | | |
| V_{DD1} | | All inputs 0 DC | — | 2.1 | 3.2 | mA |
| V_{DD2} | | All inputs 0 DC | — | 3.4 | 5.1 | |
| V_{DD1} | | All inputs 1 DC | — | 7.1 | 10.7 | |
| V_{DD2} | | All inputs 1 DC | — | 4.5 | 6.8 | |
| Si8462Ax, Bx | | | | | | |
| V_{DD1} | | All inputs 0 DC | — | 2.5 | 3.8 | mA |
| V_{DD2} | | All inputs 0 DC | — | 3.0 | 4.5 | |
| V_{DD1} | | All inputs 1 DC | — | 6.5 | 9.8 | |
| V_{DD2} | | All inputs 1 DC | — | 5.0 | 8.3 | |
| Si8463Ax, Bx | | | | | | |
| V_{DD1} | | All inputs 0 DC | — | 2.8 | 4.2 | mA |
| V_{DD2} | | All inputs 0 DC | — | 2.8 | 4.2 | |
| V_{DD1} | | All inputs 1 DC | — | 6.0 | 9.0 | |
| V_{DD2} | | All inputs 1 DC | — | 6.0 | 9.0 | |
| Notes: | | | | | | |
| <ol style="list-style-type: none"> 1. The nominal output impedance of an isolator driver channel is approximately $85\ \Omega$, $\pm 40\%$, which is a combination of the value of the on-chip series termination resistor and channel resistance of the output driver FET. When driving loads where transmission line effects will be a factor, output pins should be appropriately terminated with controlled impedance PCB traces. 2. $t_{PSK(P-P)}$ is the magnitude of the difference in propagation delay times measured between different units operating at the same supply voltages, load, and ambient temperature. 3. Start-up time is the time period from the application of power to valid data at the output. | | | | | | |

Table 4. Electrical Characteristics (Continued)(V_{DD1} = 3.3 V±10%, V_{DD2} = 3.3 V±10%, T_A = -40 to 125 °C; applies to narrow-body SOIC package)

| Parameter | Symbol | Test Condition | Min | Typ | Max | Unit |
|--|--------|----------------|-----|-----|-----|------|
| 1 Mbps Supply Current (All inputs = 500 kHz square wave, CI = 15 pF on all outputs) | | | | | | |
| Si8460Ax, Bx | | | | | | |
| V _{DD1} | | | — | 4.7 | 7.1 | mA |
| V _{DD2} | | | — | 4.0 | 6.0 | |
| Si8461Ax, Bx | | | | | | |
| V _{DD1} | | | — | 4.7 | 7.1 | mA |
| V _{DD2} | | | — | 4.5 | 6.8 | |
| Si8462Ax, Bx | | | | | | |
| V _{DD1} | | | — | 4.7 | 7.1 | mA |
| V _{DD2} | | | — | 4.3 | 6.5 | |
| Si8463Ax, Bx | | | | | | |
| V _{DD1} | | | — | 4.7 | 7.1 | mA |
| V _{DD2} | | | — | 4.7 | 7.1 | |
| 10 Mbps Supply Current (All inputs = 5 MHz square wave, CI = 15 pF on all outputs) | | | | | | |
| Si8460Bx | | | | | | |
| V _{DD1} | | | — | 4.7 | 7.1 | mA |
| V _{DD2} | | | — | 5.5 | 7.7 | |
| Si8461Bx | | | | | | |
| V _{DD1} | | | — | 5.0 | 7.2 | mA |
| V _{DD2} | | | — | 5.7 | 8.0 | |
| Si8462Bx | | | | | | |
| V _{DD1} | | | — | 5.2 | 7.3 | mA |
| V _{DD2} | | | — | 5.4 | 7.6 | |
| Si8463Bx | | | | | | |
| V _{DD1} | | | — | 5.5 | 7.7 | mA |
| V _{DD2} | | | — | 5.5 | 7.7 | |
| Notes: | | | | | | |
| <ol style="list-style-type: none"> 1. The nominal output impedance of an isolator driver channel is approximately 85 Ω, ±40%, which is a combination of the value of the on-chip series termination resistor and channel resistance of the output driver FET. When driving loads where transmission line effects will be a factor, output pins should be appropriately terminated with controlled impedance PCB traces. 2. t_{PSK(P-P)} is the magnitude of the difference in propagation delay times measured between different units operating at the same supply voltages, load, and ambient temperature. 3. Start-up time is the time period from the application of power to valid data at the output. | | | | | | |

Si8460/61/62/63

Table 4. Electrical Characteristics (Continued)

($V_{DD1} = 3.3 V \pm 10\%$, $V_{DD2} = 3.3 V \pm 10\%$, $T_A = -40$ to 125 °C; applies to narrow-body SOIC package)

| Parameter | Symbol | Test Condition | Min | Typ | Max | Unit |
|--|--------------------|----------------|-----|------|------|------|
| 100 Mbps Supply Current (All inputs = 50 MHz square wave, CI = 15 pF on all outputs) | | | | | | |
| Si8460Bx | | | | | | |
| V_{DD1} | | | — | 4.8 | 7.2 | mA |
| V_{DD2} | | | — | 20 | 25 | |
| Si8461Bx | | | | | | |
| V_{DD1} | | | — | 7.4 | 9.3 | mA |
| V_{DD2} | | | — | 17.7 | 22.1 | |
| Si8462Bx | | | | | | |
| V_{DD1} | | | — | 10.2 | 12.8 | mA |
| V_{DD2} | | | — | 15 | 18.8 | |
| Si8463Bx | | | | | | |
| V_{DD1} | | | — | 12.7 | 15.9 | mA |
| V_{DD2} | | | — | 12.7 | 15.9 | |
| Timing Characteristics | | | | | | |
| Si846xAx | | | | | | |
| Maximum Data Rate | | | 0 | — | 1.0 | Mbps |
| Minimum Pulse Width | | | — | — | 250 | ns |
| Propagation Delay | t_{PHL}, t_{PLH} | See Figure 1 | — | — | 35 | ns |
| Pulse Width Distortion $ t_{PLH} - t_{PHL} $ | PWD | See Figure 1 | — | — | 25 | ns |
| Propagation Delay Skew ² | $t_{PSK(P-P)}$ | | — | — | 40 | ns |
| Channel-Channel Skew | t_{PSK} | | — | — | 35 | ns |
| Si846xBx | | | | | | |
| Maximum Data Rate | | | 0 | — | 150 | Mbps |
| Minimum Pulse Width | | | — | — | 6.0 | ns |
| Propagation Delay | t_{PHL}, t_{PLH} | See Figure 1 | 3.0 | 6.0 | 9.5 | ns |
| Pulse Width Distortion $ t_{PLH} - t_{PHL} $ | PWD | See Figure 1 | — | 1.5 | 2.5 | ns |
| Propagation Delay Skew ² | $t_{PSK(P-P)}$ | | — | 2.0 | 3.0 | ns |
| Channel-Channel Skew | t_{PSK} | | — | 0.5 | 1.8 | ns |
| Notes: | | | | | | |
| <ol style="list-style-type: none"> 1. The nominal output impedance of an isolator driver channel is approximately 85Ω, $\pm 40\%$, which is a combination of the value of the on-chip series termination resistor and channel resistance of the output driver FET. When driving loads where transmission line effects will be a factor, output pins should be appropriately terminated with controlled impedance PCB traces. 2. $t_{PSK(P-P)}$ is the magnitude of the difference in propagation delay times measured between different units operating at the same supply voltages, load, and ambient temperature. 3. Start-up time is the time period from the application of power to valid data at the output. | | | | | | |

Table 4. Electrical Characteristics (Continued)(V_{DD1} = 3.3 V±10%, V_{DD2} = 3.3 V±10%, T_A = -40 to 125 °C; applies to narrow-body SOIC package)

| Parameter | Symbol | Test Condition | Min | Typ | Max | Unit |
|--------------------------------|-----------------|---|-----|-----|-----|-------|
| All Models | | | | | | |
| Output Rise Time | t _r | C _L = 15 pF See Figure 1 | — | 4.3 | 6.1 | ns |
| Output Fall Time | t _f | C _L = 15 pF See Figure 1 | — | 3.0 | 4.3 | ns |
| Common Mode Transient Immunity | CMTI | V _I = V _{DD} or 0 V | — | 25 | — | kV/μs |
| Start-up Time ³ | t _{SU} | | — | 15 | 40 | μs |

Notes:

1. The nominal output impedance of an isolator driver channel is approximately 85 Ω, ±40%, which is a combination of the value of the on-chip series termination resistor and channel resistance of the output driver FET. When driving loads where transmission line effects will be a factor, output pins should be appropriately terminated with controlled impedance PCB traces.
2. t_{PSK(P-P)} is the magnitude of the difference in propagation delay times measured between different units operating at the same supply voltages, load, and ambient temperature.
3. Start-up time is the time period from the application of power to valid data at the output.

Si8460/61/62/63

Table 5. Electrical Characteristics¹

($V_{DD1} = 2.70\text{ V}$, $V_{DD2} = 2.70\text{ V}$, $T_A = -40\text{ to }125\text{ }^\circ\text{C}$; applies to narrow-body SOIC package)

| Parameter | Symbol | Test Condition | Min | Typ | Max | Unit |
|--|----------|-------------------------|--------------------------|-----|----------|---------------|
| High Level Input Voltage | V_{IH} | | 2.0 | — | — | V |
| Low Level Input Voltage | V_{IL} | | — | — | 0.8 | V |
| High Level Output Voltage | V_{OH} | $I_{OH} = -4\text{ mA}$ | $V_{DD1}, V_{DD2} - 0.4$ | 2.3 | — | V |
| Low Level Output Voltage | V_{OL} | $I_{OL} = 4\text{ mA}$ | — | 0.2 | 0.4 | V |
| Input Leakage Current | I_L | | — | — | ± 10 | μA |
| Output Impedance ² | Z_O | | — | 85 | — | Ω |
| DC Supply Current (All inputs 0 V or at supply) | | | | | | |
| Si8460Ax, Bx | | | | | | |
| V_{DD1} | | All inputs 0 DC | — | 1.7 | 2.6 | mA |
| V_{DD2} | | All inputs 0 DC | — | 3.3 | 5.0 | |
| V_{DD1} | | All inputs 1 DC | — | 7.7 | 11.6 | |
| V_{DD2} | | All inputs 1 DC | — | 3.5 | 5.3 | |
| Si8461Ax, Bx | | | | | | |
| V_{DD1} | | All inputs 0 DC | — | 2.1 | 3.2 | mA |
| V_{DD2} | | All inputs 0 DC | — | 3.4 | 5.1 | |
| V_{DD1} | | All inputs 1 DC | — | 7.1 | 10.7 | |
| V_{DD2} | | All inputs 1 DC | — | 4.5 | 6.8 | |
| Si8462Ax, Bx | | | | | | |
| V_{DD1} | | All inputs 0 DC | — | 2.5 | 3.8 | mA |
| V_{DD2} | | All inputs 0 DC | — | 3.0 | 4.5 | |
| V_{DD1} | | All inputs 1 DC | — | 6.5 | 9.8 | |
| V_{DD2} | | All inputs 1 DC | — | 5.0 | 8.3 | |
| Si8463Ax, Bx | | | | | | |
| V_{DD1} | | All inputs 0 DC | — | 2.8 | 4.2 | mA |
| V_{DD2} | | All inputs 0 DC | — | 2.8 | 4.2 | |
| V_{DD1} | | All inputs 1 DC | — | 6.0 | 9.0 | |
| V_{DD2} | | All inputs 1 DC | — | 6.0 | 9.0 | |
| Notes: | | | | | | |
| 1. Specifications in this table are also valid at $V_{DD1} = 2.6\text{ V}$ and $V_{DD2} = 2.6\text{ V}$ when the operating temperature range is constrained to $T_A = 0\text{ to }85\text{ }^\circ\text{C}$. | | | | | | |
| 2. The nominal output impedance of an isolator driver channel is approximately $85\ \Omega$, $\pm 40\%$, which is a combination of the value of the on-chip series termination resistor and channel resistance of the output driver FET. When driving loads where transmission line effects will be a factor, output pins should be appropriately terminated with controlled impedance PCB traces. | | | | | | |
| 3. $t_{PSK(P-P)}$ is the magnitude of the difference in propagation delay times measured between different units operating at the same supply voltages, load, and ambient temperature. | | | | | | |
| 4. Start-up time is the time period from the application of power to valid data at the output. | | | | | | |

Table 5. Electrical Characteristics¹ (Continued)(V_{DD1} = 2.70 V, V_{DD2} = 2.70 V, T_A = -40 to 125 °C; applies to narrow-body SOIC package)

| Parameter | Symbol | Test Condition | Min | Typ | Max | Unit |
|--|--------|----------------|-----|-----|-----|------|
| 1 Mbps Supply Current (All inputs = 500 kHz square wave, CI = 15 pF on all outputs) | | | | | | |
| Si8460Ax, Bx | | | | | | |
| V _{DD1} | | | — | 4.7 | 7.1 | mA |
| V _{DD2} | | | — | 4.0 | 6.0 | |
| Si8461Ax, Bx | | | | | | |
| V _{DD1} | | | — | 4.7 | 7.1 | mA |
| V _{DD2} | | | — | 4.5 | 6.8 | |
| Si8462Ax, Bx | | | | | | |
| V _{DD1} | | | — | 4.7 | 7.1 | mA |
| V _{DD2} | | | — | 4.3 | 6.5 | |
| Si8463Ax, Bx | | | | | | |
| V _{DD1} | | | — | 4.7 | 7.1 | mA |
| V _{DD2} | | | — | 4.7 | 7.1 | |
| 10 Mbps Supply Current (All inputs = 5 MHz square wave, CI = 15 pF on all outputs) | | | | | | |
| Si8460Bx | | | | | | |
| V _{DD1} | | | — | 4.7 | 7.1 | mA |
| V _{DD2} | | | — | 5.5 | 7.7 | |
| Si8461Bx | | | | | | |
| V _{DD1} | | | — | 5.0 | 7.2 | mA |
| V _{DD2} | | | — | 5.7 | 8.0 | |
| Si8462Bx | | | | | | |
| V _{DD1} | | | — | 5.2 | 7.3 | mA |
| V _{DD2} | | | — | 5.4 | 7.6 | |
| Si8463Bx | | | | | | |
| V _{DD1} | | | — | 5.5 | 7.7 | mA |
| V _{DD2} | | | — | 5.5 | 7.7 | |
| Notes: | | | | | | |
| <ol style="list-style-type: none"> Specifications in this table are also valid at V_{DD1} = 2.6 V and V_{DD2} = 2.6 V when the operating temperature range is constrained to T_A = 0 to 85 °C. The nominal output impedance of an isolator driver channel is approximately 85 Ω, ±40%, which is a combination of the value of the on-chip series termination resistor and channel resistance of the output driver FET. When driving loads where transmission line effects will be a factor, output pins should be appropriately terminated with controlled impedance PCB traces. t_{PSK(P-P)} is the magnitude of the difference in propagation delay times measured between different units operating at the same supply voltages, load, and ambient temperature. Start-up time is the time period from the application of power to valid data at the output. | | | | | | |

Si8460/61/62/63

Table 5. Electrical Characteristics¹ (Continued)

($V_{DD1} = 2.70\text{ V}$, $V_{DD2} = 2.70\text{ V}$, $T_A = -40\text{ to }125\text{ }^\circ\text{C}$; applies to narrow-body SOIC package)

| Parameter | Symbol | Test Condition | Min | Typ | Max | Unit |
|--|--------------------|----------------|-----|------|------|------|
| 100 Mbps Supply Current (All inputs = 50 MHz square wave, CI = 15 pF on all outputs) | | | | | | |
| Si8460Bx | | | | | | |
| V_{DD1} | | | — | 4.8 | 7.2 | mA |
| V_{DD2} | | | — | 15.8 | 19.8 | |
| Si8461Bx | | | | | | |
| V_{DD1} | | | — | 6.7 | 8.4 | mA |
| V_{DD2} | | | — | 14.2 | 17.8 | |
| Si8462Bx | | | | | | |
| V_{DD1} | | | — | 8.7 | 10.9 | mA |
| V_{DD2} | | | — | 12.2 | 15.3 | |
| Si8463Bx | | | | | | |
| V_{DD1} | | | — | 10.5 | 13.1 | mA |
| V_{DD2} | | | — | 10.5 | 13.1 | |
| Timing Characteristics | | | | | | |
| Si846xAx | | | | | | |
| Maximum Data Rate | | | 0 | — | 1.0 | Mbps |
| Minimum Pulse Width | | | — | — | 250 | ns |
| Propagation Delay | t_{PHL}, t_{PLH} | See Figure 1 | — | — | 35 | ns |
| Pulse Width Distortion $ t_{PLH} - t_{PHL} $ | PWD | See Figure 1 | — | — | 25 | ns |
| Propagation Delay Skew ³ | $t_{PSK(P-P)}$ | | — | — | 40 | ns |
| Channel-Channel Skew | t_{PSK} | | — | — | 35 | ns |
| Si846xBx | | | | | | |
| Maximum Data Rate | | | 0 | — | 150 | Mbps |
| Minimum Pulse Width | | | — | — | 6.0 | ns |
| Propagation Delay | t_{PHL}, t_{PLH} | See Figure 1 | 3.0 | 6.0 | 9.5 | ns |
| Pulse Width Distortion $ t_{PLH} - t_{PHL} $ | PWD | See Figure 1 | — | 1.5 | 2.5 | ns |
| Propagation Delay Skew ³ | $t_{PSK(P-P)}$ | | — | 2.0 | 3.0 | ns |
| Channel-Channel Skew | t_{PSK} | | — | 0.5 | 1.8 | ns |
| Notes: | | | | | | |
| <ol style="list-style-type: none"> Specifications in this table are also valid at $V_{DD1} = 2.6\text{ V}$ and $V_{DD2} = 2.6\text{ V}$ when the operating temperature range is constrained to $T_A = 0\text{ to }85\text{ }^\circ\text{C}$. The nominal output impedance of an isolator driver channel is approximately $85\ \Omega$, $\pm 40\%$, which is a combination of the value of the on-chip series termination resistor and channel resistance of the output driver FET. When driving loads where transmission line effects will be a factor, output pins should be appropriately terminated with controlled impedance PCB traces. $t_{PSK(P-P)}$ is the magnitude of the difference in propagation delay times measured between different units operating at the same supply voltages, load, and ambient temperature. Start-up time is the time period from the application of power to valid data at the output. | | | | | | |

Table 5. Electrical Characteristics¹ (Continued)(V_{DD1} = 2.70 V, V_{DD2} = 2.70 V, T_A = -40 to 125 °C; applies to narrow-body SOIC package)

| Parameter | Symbol | Test Condition | Min | Typ | Max | Unit |
|--------------------------------|-----------------|---|-----|-----|-----|-------|
| All Models | | | | | | |
| Output Rise Time | t _r | C _L = 15 pF See Figure 1 | — | 4.8 | 6.5 | ns |
| Output Fall Time | t _f | C _L = 15 pF See Figure 1 | — | 3.2 | 4.6 | ns |
| Common Mode Transient Immunity | CMTI | V _I = V _{DD} or 0 V | — | 25 | — | kV/μs |
| Start-up Time ⁴ | t _{SU} | | — | 15 | 40 | μs |

Notes:

- Specifications in this table are also valid at V_{DD1} = 2.6 V and V_{DD2} = 2.6 V when the operating temperature range is constrained to T_A = 0 to 85 °C.
- The nominal output impedance of an isolator driver channel is approximately 85 Ω, ±40%, which is a combination of the value of the on-chip series termination resistor and channel resistance of the output driver FET. When driving loads where transmission line effects will be a factor, output pins should be appropriately terminated with controlled impedance PCB traces.
- t_{PSK(P-P)} is the magnitude of the difference in propagation delay times measured between different units operating at the same supply voltages, load, and ambient temperature.
- Start-up time is the time period from the application of power to valid data at the output.

Table 6. Regulatory Information*

| |
|--|
| CSA |
| The Si84xx is certified under CSA Component Acceptance Notice 5A. For more details, see File 232873. |
| 61010-1: Up to 300 V _{RMS} reinforced insulation working voltage; up to 600 V _{RMS} basic insulation working voltage. |
| 60950-1: Up to 130 V _{RMS} reinforced insulation working voltage; up to 600 V _{RMS} basic insulation working voltage. |
| VDE |
| The Si84xx is certified according to IEC 60747-5-2. For more details, see File 5006301-4880-0001. |
| 60747-5-2: Up to 560 V _{peak} for basic insulation working voltage. |
| UL |
| The Si84xx is certified under UL1577 component recognition program. For more details, see File E257455. |
| Rated up to 2500 V _{RMS} isolation voltage for basic insulation. |
| *Note: Regulatory Certifications apply to 2.5 kV _{RMS} rated devices which are production tested to 3.0 kV _{RMS} for 1 sec. For more information, see "5. Ordering Guide" on page 28. |

Table 7. Insulation and Safety-Related Specifications

| Parameter | Symbol | Test Condition | Value | Unit |
|---|-----------------|----------------|------------------|------------------|
| | | | NB SOIC-16 | |
| Nominal Air Gap (Clearance) ¹ | L(IO1) | | 3.9 min | mm |
| Nominal External Tracking (Creepage) ¹ | L(IO2) | | 3.9 min | mm |
| Minimum Internal Gap (Internal Clearance) | | | 0.008 | mm |
| Tracking Resistance (Proof Tracking Index) | PTI | IEC60112 | 600 | V _{RMS} |
| Erosion Depth | ED | | 0.019 | mm |
| Resistance (Input-Output) ² | R _{IO} | | 10 ¹² | Ω |
| Capacitance (Input-Output) ² | C _{IO} | f = 1 MHz | 2.0 | pF |
| Input Capacitance ³ | C _I | | 4.0 | pF |

Notes:

- The values in this table correspond to the nominal creepage and clearance values as detailed in “6. Package Outline: 16-Pin Narrow Body SOIC”. VDE certifies the clearance and creepage limits as 4.7 mm minimum for the NB SOIC-16 package. UL does not impose a clearance and creepage minimum for component level certifications. CSA certifies the clearance and creepage limits as 3.9 mm minimum for the NB SOIC-16 package.
- To determine resistance and capacitance, the Si84xx is converted into a 2-terminal device. Pins 1–8 are shorted together to form the first terminal and pins 9–16 are shorted together to form the second terminal. The parameters are then measured between these two terminals.
- Measured from input pin to ground.

Table 8. IEC 60664-1 (VDE 0844 Part 2) Ratings

| Parameter | Test Condition | Specification |
|-----------------------------|---|---------------|
| Basic Isolation Group | Material Group | I |
| Installation Classification | Rated Mains Voltages ≤ 150 V _{RMS} | I-IV |
| | Rated Mains Voltages ≤ 300 V _{RMS} | I-III |
| | Rated Mains Voltages ≤ 400 V _{RMS} | I-II |
| | Rated Mains Voltages ≤ 600 V _{RMS} | I-II |

Table 9. IEC 60747-5-2 Insulation Characteristics for Si84xxxB*

| Parameter | Symbol | Test Condition | Characteristic | Unit |
|---|------------|--|----------------|----------|
| Maximum Working Insulation Voltage | V_{IORM} | | 560 | V peak |
| Input to Output Test Voltage | V_{PR} | Method b1 ($V_{IORM} \times 1.875 = V_{PR}$, 100% Production Test, $t_m = 1$ sec, Partial Discharge < 5 pC) | 1050 | V peak |
| Transient Overvoltage | V_{IOTM} | $t = 60$ sec | 4000 | V peak |
| Pollution Degree (DIN VDE 0110, Table 1) | | | 2 | |
| Insulation Resistance at T_S , $V_{IO} = 500$ V | R_S | | $>10^9$ | Ω |

***Note:** Maintenance of the safety data is ensured by protective circuits. The Si84xx provides a climate classification of 40/125/21.

Table 10. IEC Safety Limiting Values¹

| Parameter | Symbol | Test Condition | Min | Typ | Max | Unit |
|---|--------|--|-----|-----|------------|------|
| | | | | | NB SOIC-16 | |
| Case Temperature | T_S | | — | — | 150 | °C |
| Safety input, output, or supply current | I_S | $\theta_{JA} = 105$ °C/W (NB SOIC-16), $V_I = 5.5$ V, $T_J = 150$ °C, $T_A = 25$ °C | — | — | 215 | mA |
| Device Power Dissipation ² | P_D | | — | — | 415 | mW |

Notes:

- Maximum value allowed in the event of a failure; also see the thermal derating curve in Figure 2.
- The Si846x is tested with $VDD1 = VDD2 = 5.5$ V, $T_J = 150$ °C, $CL = 15$ pF, input a 150 Mbps 50% duty cycle square wave.

Table 11. Thermal Characteristics

| Parameter | Symbol | Test Condition | Min | Typ | Max | Unit |
|---------------------------------------|---------------|----------------|-----|------------|-----|------|
| | | | | NB SOIC-16 | | |
| IC Junction-to-Air Thermal Resistance | θ_{JA} | | — | 105 | — | °C/W |

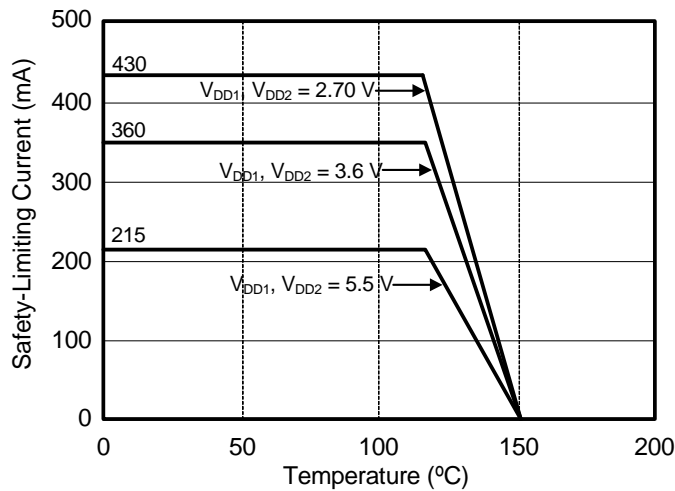

Figure 2. (NB SOIC-16) Thermal Derating Curve, Dependence of Safety Limiting Values with Case Temperature per DIN EN 60747-5-2

2. Functional Description

2.1. Theory of Operation

The operation of an Si846x channel is analogous to that of an opto coupler, except an RF carrier is modulated instead of light. This simple architecture provides a robust isolated data path and requires no special considerations or initialization at start-up. A simplified block diagram for a single Si846x channel is shown in Figure 3.

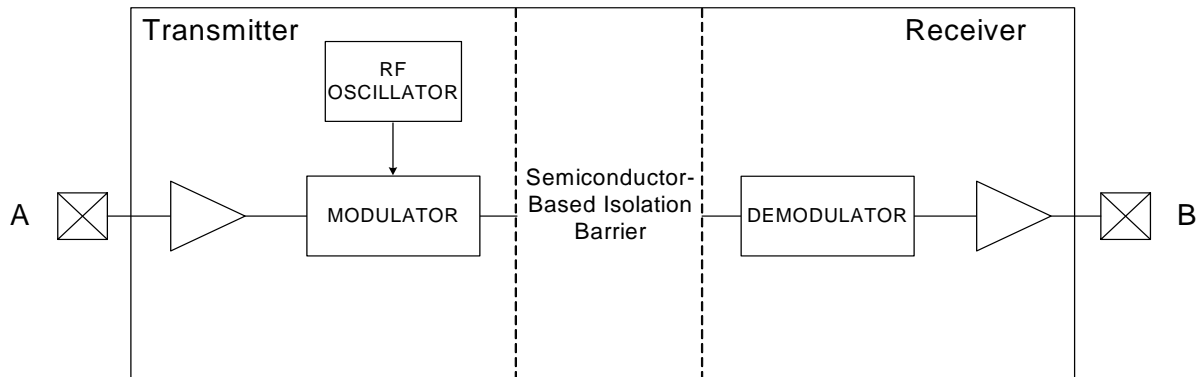

Figure 3. Simplified Channel Diagram

A channel consists of an RF Transmitter and RF Receiver separated by a semiconductor-based isolation barrier. Referring to the Transmitter, input A modulates the carrier provided by an RF oscillator using on/off keying. The Receiver contains a demodulator that decodes the input state according to its RF energy content and applies the result to output B via the output driver. This RF on/off keying scheme is superior to pulse code schemes as it provides best-in-class noise immunity, low power consumption, and better immunity to magnetic fields. See Figure 4 for more details.

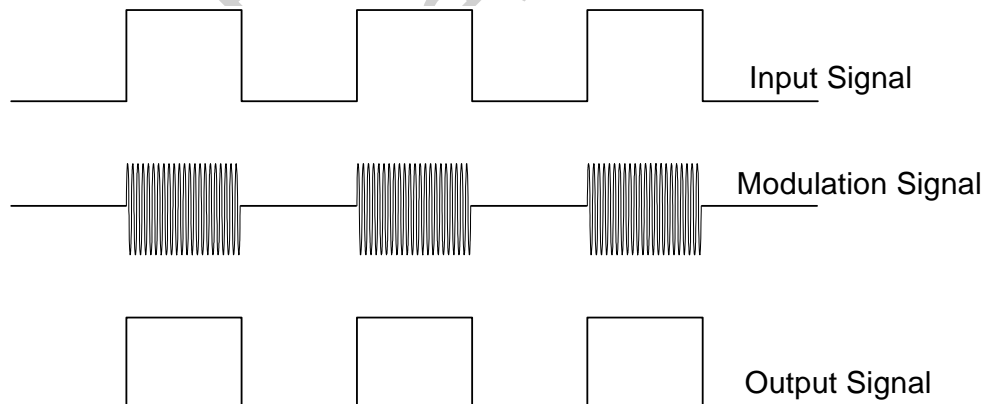

Figure 4. Modulation Scheme

2.2. Eye Diagram

Figure 5 illustrates an eye-diagram taken on an Si8460. For the data source, the test used an Anritsu (MP1763C) Pulse Pattern Generator set to 1000 ns/div. The output of the generator's clock and data from an Si8460 were captured on an oscilloscope. The results illustrate that data integrity was maintained even at the high data rate of 150 Mbps. The results also show that 2 ns pulse width distortion and 250 ps peak jitter were exhibited.

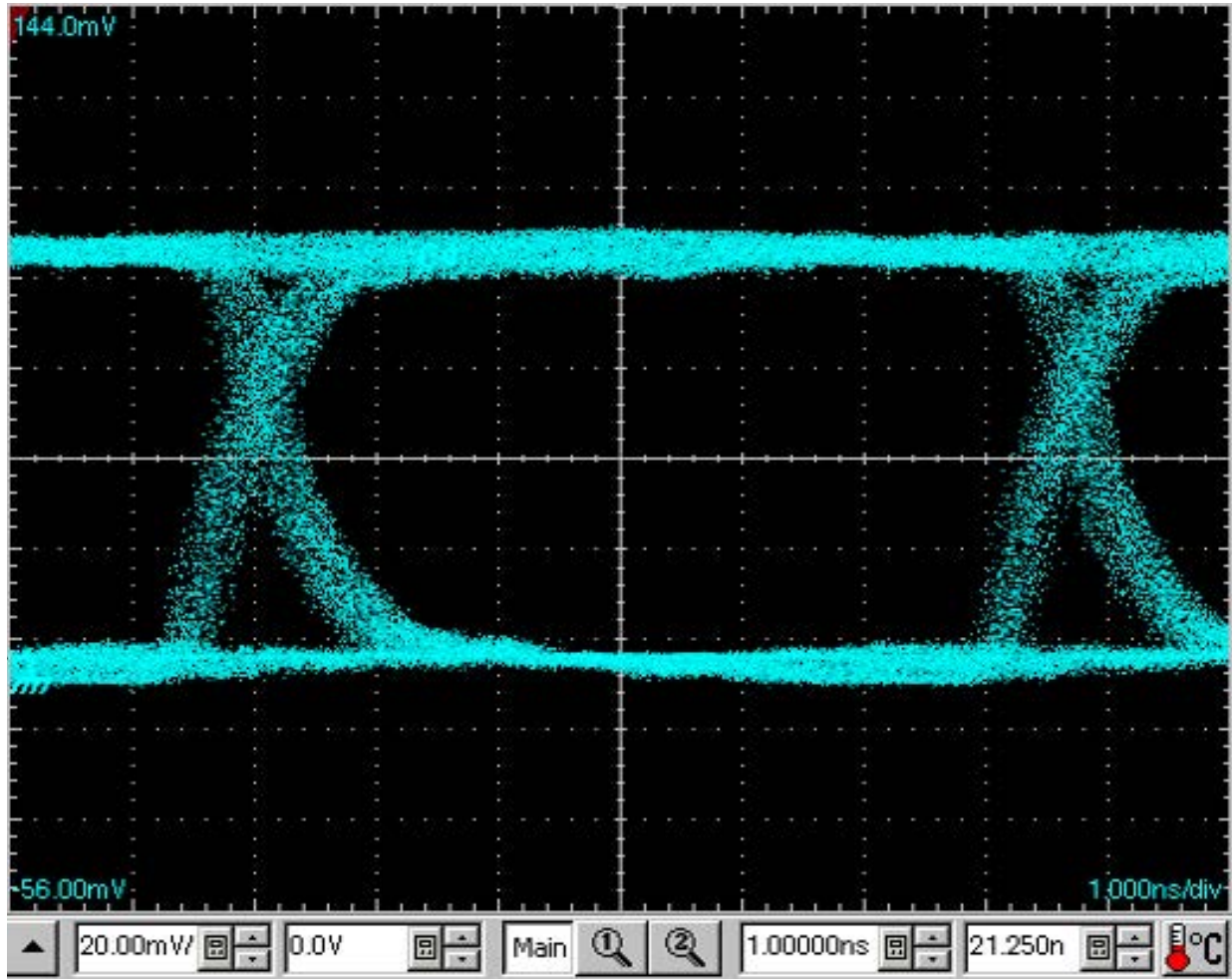

Figure 5. Eye Diagram

2.3. Device Operation

Device behavior during startup, normal operation, and shutdown is shown in Table 12.

Table 12. Si846x Logic Operation Table

| V_I Input ^{1,2} | VDDI State ^{1,3,4} | VDDO State ^{1,3,4} | V_O Output ^{1,2} | Comments |
|-------------------------------|--------------------------------|--------------------------------|-----------------------------|---|
| H | P | P | H | Normal operation. |
| L | P | P | L | |
| X ⁵ | UP | P | L | Upon transition of VDDI from unpowered to powered, V_O returns to the same state as V_I in less than 1 μ s. |
| X ⁵ | P | UP | Undetermined | Upon transition of VDDO from unpowered to powered, V_O returns to the same state as V_I within 1 μ s. |

Notes:

- VDDI and VDDO are the input and output power supplies. V_I and V_O are the respective input and output terminals.
- X = not applicable; H = Logic High; L = Logic Low; Hi-Z = High Impedance.
- "Powered" state (P) is defined as 2.70 V < VDD < 5.5 V.
- "Unpowered" state (UP) is defined as VDD = 0 V.
- Note that an I/O can power the die for a given side through an internal diode if its source has adequate current.

2.4. Layout Recommendations

To ensure safety in the end user application, high voltage circuits (i.e., circuits with $>30 V_{AC}$) must be physically separated from the safety extra-low voltage circuits (SELV is a circuit with $<30 V_{AC}$) by a certain distance (creepage/clearance). If a component, such as a digital isolator, straddles this isolation barrier, it must meet those creepage/clearance requirements and also provide a sufficiently large high-voltage breakdown protection rating (commonly referred to as working voltage protection). Table 6 on page 15 and Table 7 on page 16 detail the working voltage and creepage/clearance capabilities of the Si84xx. These tables also detail the component standards (UL1577, IEC60747, CSA 5A), which are readily accepted by certification bodies to provide proof for end-system specifications requirements. Refer to the end-system specification (61010-1, 60950-1, etc.) requirements before starting any design that uses a digital isolator.

The following sections detail the recommended bypass and decoupling components necessary to ensure robust overall performance and reliability for systems using the Si84xx digital isolators.

2.4.1. Supply Bypass

Digital integrated circuit components typically require $0.1 \mu F$ (100 nF) bypass capacitors when used in electrically quiet environments. However, digital isolators are commonly used in hazardous environments with excessively noisy power supplies. To counteract these harsh conditions, it is recommended that an additional $1 \mu F$ bypass capacitor be added between VDD and GND on both sides of the package. The capacitors should be placed as close as possible to the package to minimize stray inductance. If the system is excessively noisy, it is recommended that the designer add 50 to 100Ω resistors in series with the VDD supply voltage source and 50 to 300Ω resistors in series with the digital inputs/outputs (see Figure 6). For more details, see "3. Errata and Design Migration Guidelines" on page 26.

All components upstream or downstream of the isolator should be properly decoupled as well. If these components are not properly decoupled, their supply noise can couple to the isolator inputs and outputs, potentially causing damage if spikes exceed the maximum ratings of the isolator (6 V). In this case, the 50 to 300Ω resistors protect the isolator's inputs/outputs (note that permanent device damage may occur if the absolute maximum ratings are exceeded). Functional operation should be restricted to the conditions specified in Table 1, "Recommended Operating Conditions," on page 3.

2.4.2. Pin Connections

No connect pins are not internally connected. They can be left floating, tied to V_{DD} , or tied to GND.

2.4.3. Output Pin Termination

The nominal output impedance of an isolator driver channel is approximately 85Ω , $\pm 40\%$, which is a combination of the value of the on-chip series termination resistor and channel resistance of the output driver FET. When driving loads where transmission line effects will be a factor, output pins should be appropriately terminated with controlled impedance PCB traces. The series termination resistor values should be scaled appropriately while keeping in mind the recommendations described in "2.4.1. Supply Bypass" above.

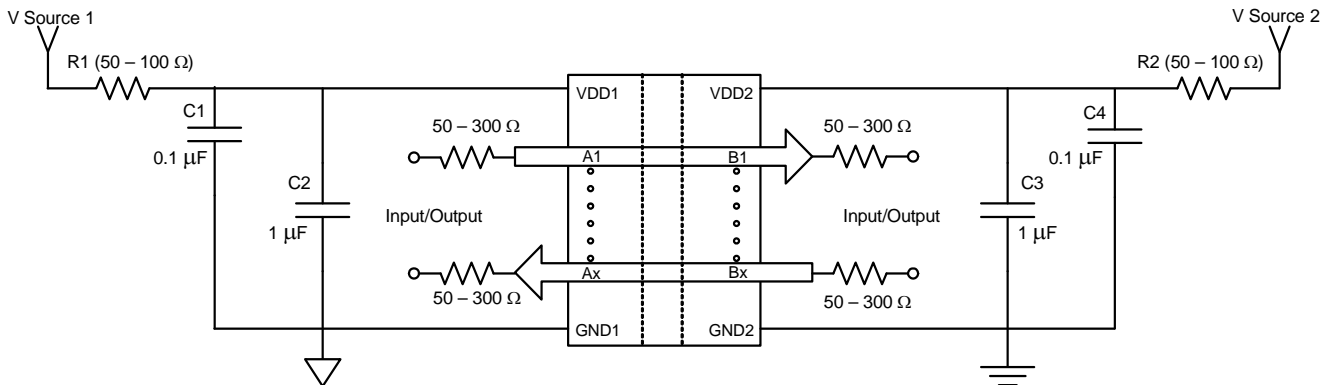

Figure 6. Recommended Bypass Components for the Si84xx Digital Isolator Family

2.5. Typical Performance Characteristics

The typical performance characteristics depicted in the following diagrams are for information purposes only. Refer to Tables 3, 4, and 5 for actual specification limits.

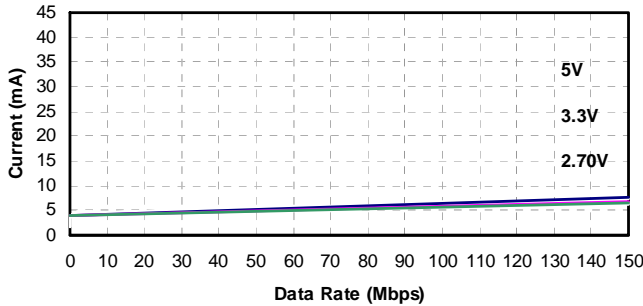

Figure 7. Si8460 Typical V_{DD1} Supply Current vs. Data Rate 5, 3.3, and 2.70 V Operation

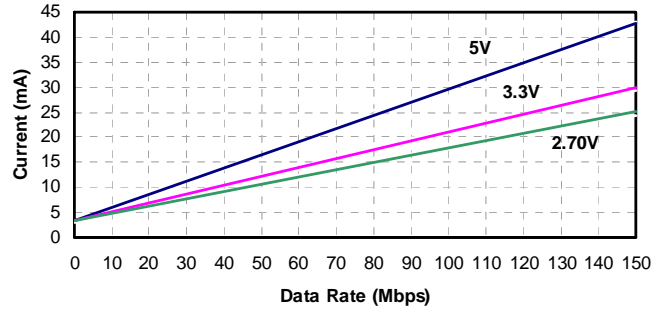

Figure 10. Si8460 Typical V_{DD2} Supply Current vs. Data Rate 5, 3.3, and 2.70 V Operation (15 pF Load)

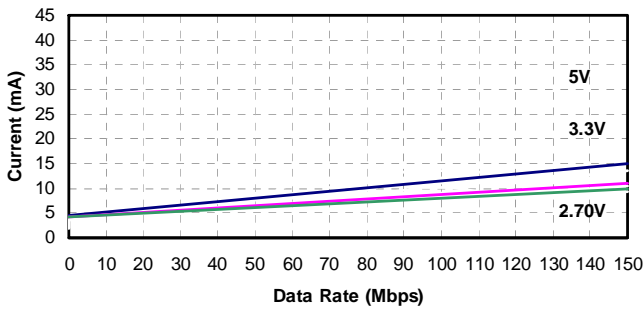

Figure 8. Si8461 Typical V_{DD1} Supply Current vs. Data Rate 5, 3.3, and 2.70 V Operation (15 pF Load)

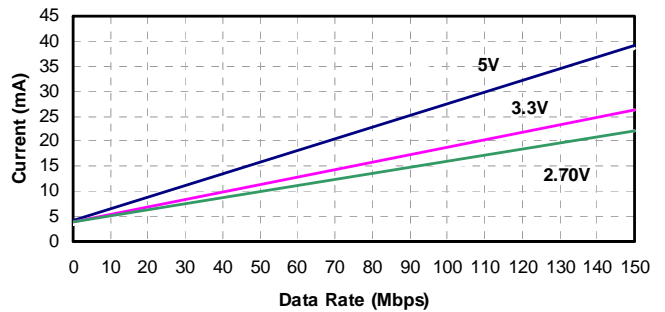

Figure 11. Si8461 Typical V_{DD2} Supply Current vs. Data Rate 5, 3.3, and 2.70 V Operation (15 pF Load)

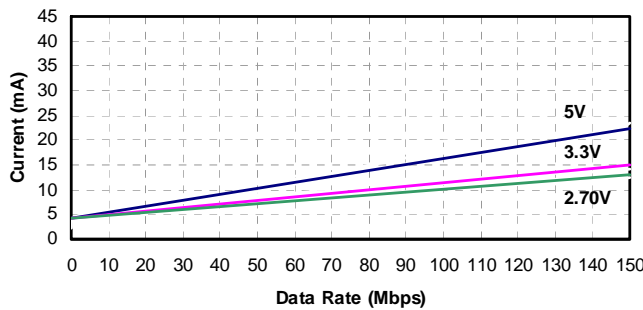

Figure 9. Si8462 Typical V_{DD1} Supply Current vs. Data Rate 5, 3.3, and 2.70 V Operation (15 pF Load)

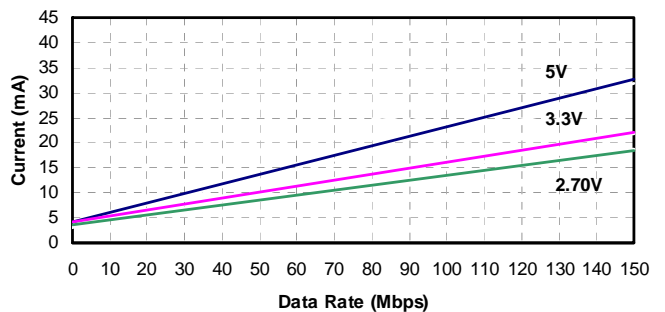

Figure 12. Si8462 Typical V_{DD2} Supply Current vs. Data Rate 5, 3.3, and 2.70 V Operation (15 pF Load)

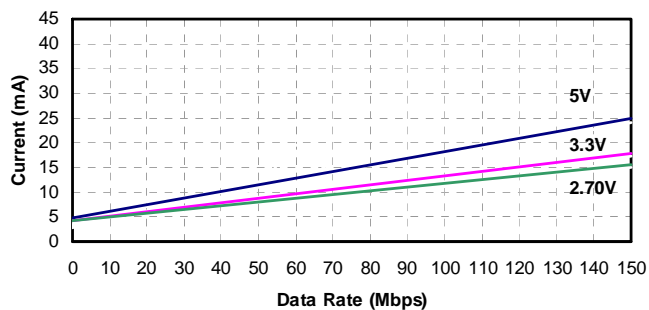

Figure 13. Si8463 Typical V_{DD1} or V_{DD2} Supply Current vs. Data Rate 5, 3.3, and 2.70 V Operation (15 pF Load)

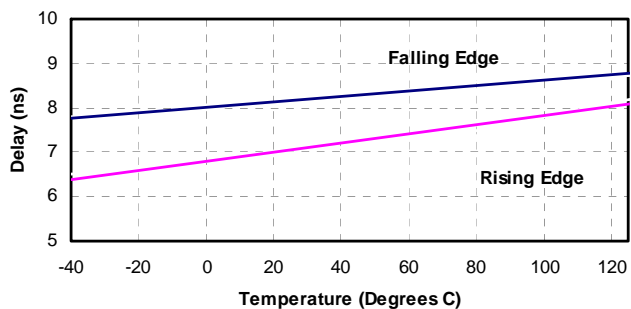

Figure 14. Propagation Delay vs. Temperature

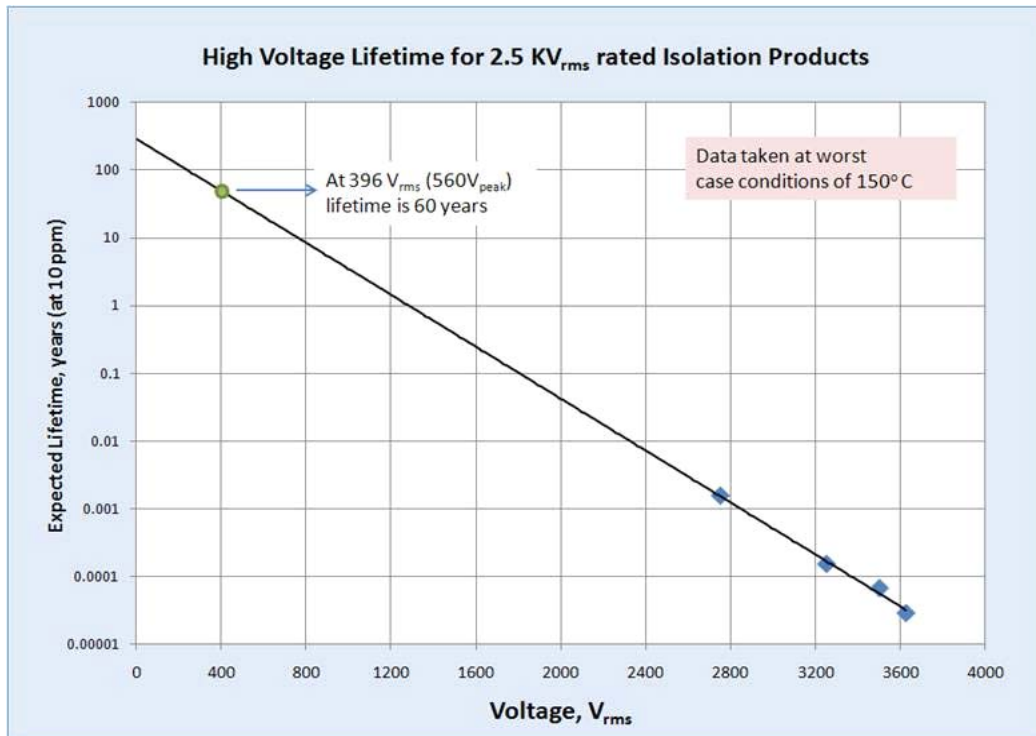

Figure 15. Si84xx Time-Dependent Dielectric Breakdown

3. Errata and Design Migration Guidelines

When using the new Si846x products, or when migrating from Silicon Labs' legacy isolators, designers must consider and adhere to the following requirements.

3.1. Power Supply Bypass Capacitors (Revision A and Revision B)

When using the Si846x isolators with power supplies ≥ 4.5 V, sufficient VDD bypass capacitors must be present on both the VDD1 and VDD2 pins to ensure the VDD rise time is less than $0.5 \text{ V}/\mu\text{s}$ (which is $> 9 \mu\text{s}$ for a ≥ 4.5 V supply). Although rise time is power supply dependent, $\geq 1 \mu\text{F}$ capacitors are required on both power supply pins (VDD1, VDD2) of the isolator device.

3.1.1. Resolution

For recommendations on resolving this issue, see "2.4.1. Supply Bypass" on page 22. Additionally, refer to "5. Ordering Guide" on page 28 for current ordering information.

3.2. Latch Up Immunity (Revision A Only)

Latch up immunity generally exceeds ± 200 mA per pin. Exceptions: Certain pins provide < 100 mA of latch-up immunity. To increase latch-up immunity on these pins, 100Ω of equivalent resistance must be included in series with *all* of the pins listed in Table 13. The 100Ω equivalent resistance can be comprised of the source driver's output resistance and a series termination resistor.

3.2.1. Resolution

This issue has been corrected with Revision B of the device. Refer to "5. Ordering Guide" on page 28 for more information.

Table 13. Affected Ordering Part Numbers (Revision A Only)

| Affected Ordering Part Numbers* | Device Revision | Pin# | Name | Pin Type |
|---|-----------------|------|------|-----------------|
| SI8460SV-A-IS/IS1, SI8461SV-A-IS/IS1, SI8462SV-A-IS/IS1, SI8463SV-A-IS/IS1 | A | 2 | A1 | Input |
| | | 6 | A5 | Input or Output |
| | | 10 | B6 | Input or Output |
| | | 14 | B2 | Output |
| *Note: SV = Speed Grade/Isolation Rating (AA, AB, BA, BB). | | | | |

4. Pin Descriptions

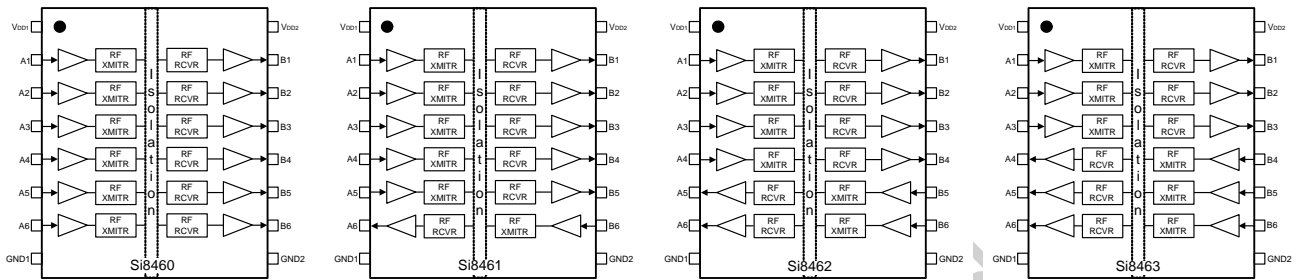

| Name | SOIC-16 Pin# | Type | Description |
|------------------|--------------|----------------|---------------------------------|
| V _{DD1} | 1 | Supply | Side 1 power supply. |
| A1 | 2 | Digital Input | Side 1 digital input. |
| A2 | 3 | Digital Input | Side 1 digital input. |
| A3 | 4 | Digital Input | Side 1 digital input. |
| A4 | 5 | Digital I/O | Side 1 digital input or output. |
| A5 | 6 | Digital I/O | Side 1 digital input or output. |
| A6 | 7 | Digital I/O | Side 1 digital input or output. |
| GND1 | 8 | Ground | Side 1 ground. |
| GND2 | 9 | Ground | Side 2 ground. |
| B6 | 10 | Digital I/O | Side 2 digital input or output. |
| B5 | 11 | Digital I/O | Side 2 digital input or output. |
| B4 | 12 | Digital I/O | Side 2 digital input or output. |
| B3 | 13 | Digital Output | Side 2 digital output. |
| B2 | 14 | Digital Output | Side 2 digital output. |
| B1 | 15 | Digital Output | Side 2 digital output. |
| V _{DD2} | 16 | Supply | Side 2 power supply. |

5. Ordering Guide

These devices are not recommended for new designs. Please see the Si866x data sheet for replacement options.

Table 14. Ordering Guide for Valid OPNs¹

| Ordering Part Number (OPN) | Alternative Part Number (APN) | Number of Inputs VDD1 Side | Number of Inputs VDD2 Side | Maximum Data Rate (Mbps) | Isolation Rating | Package Type |
|--|-------------------------------|----------------------------|----------------------------|--------------------------|------------------|--------------|
| Revision B Devices² | | | | | | |
| Si8460AA-B-IS1 | Si8660BA-B-IS1 | 6 | 0 | 1 | 1 kVrms | NB SOIC-16 |
| Si8460BA-B-IS1 | Si8660BA-B-IS1 | 6 | 0 | 150 | | |
| Si8461AA-B-IS1 | Si8661AB-B-IS1 | 5 | 1 | 1 | | |
| Si8461BA-B-IS1 | Si8661BB-B-IS1 | 5 | 1 | 150 | | |
| Si8462AA-B-IS1 | Si8662AB-B-IS1 | 4 | 2 | 1 | | |
| Si8462BA-B-IS1 | Si8662BB-B-IS1 | 4 | 2 | 150 | | |
| Si8463AA-B-IS1 | Si8663AB-B-IS1 | 3 | 3 | 1 | | |
| Si8463BA-B-IS1 | Si8663BB-B-IS1 | 3 | 3 | 150 | | |
| Si8460AB-B-IS1 | Si8660AB-B-IS1 | 6 | 0 | 1 | 2.5 kVrms | NB SOIC-16 |
| Si8460BB-B-IS1 | Si8660BB-B-IS1 | 6 | 0 | 150 | | |
| Si8461AB-B-IS1 | Si8661AB-B-IS1 | 5 | 1 | 1 | | |
| Si8461BB-B-IS1 | Si8661BB-B-IS1 | 5 | 1 | 150 | | |
| Si8462AB-B-IS1 | Si8662AB-B-IS1 | 4 | 2 | 1 | | |
| Si8462BB-B-IS1 | Si8662BB-B-IS1 | 4 | 2 | 150 | | |
| Si8463AB-B-IS1 | Si8663AB-B-IS1 | 3 | 3 | 1 | | |
| Si8463BB-B-IS1 | Si8663BB-B-IS1 | 3 | 3 | 150 | | |
| Notes: | | | | | | |
| 1. All packages are RoHS-compliant. | | | | | | |
| 2. Revision A and Revision B devices are supported for existing designs. | | | | | | |

Table 14. Ordering Guide for Valid OPNs¹

| Ordering Part Number (OPN) | Alternative Part Number (APN) | Number of Inputs VDD1 Side | Number of Inputs VDD2 Side | Maximum Data Rate (Mbps) | Isolation Rating | Package Type |
|--|-------------------------------|----------------------------|----------------------------|--------------------------|------------------|--------------|
| Revision A Devices² | | | | | | |
| Si8460AA-A-IS1 | Si8660BA-B-IS1 | 6 | 0 | 1 | 1 kVrms | NB SOIC-16 |
| Si8460BA-A-IS1 | Si8660BA-B-IS1 | 6 | 0 | 150 | | |
| Si8461AA-A-IS1 | Si8661AB-B-IS1 | 5 | 1 | 1 | | |
| Si8461BA-A-IS1 | Si8661BB-B-IS1 | 5 | 1 | 150 | | |
| Si8462AA-A-IS1 | Si8662AB-B-IS1 | 4 | 2 | 1 | | |
| Si8462BA-A-IS1 | Si8662BB-B-IS1 | 4 | 2 | 150 | | |
| Si8463AA-A-IS1 | Si8663AB-B-IS1 | 3 | 3 | 1 | | |
| Si8463BA-A-IS1 | Si8663BB-B-IS1 | 3 | 3 | 150 | | |
| Si8460AB-A-IS1 | Si8660AB-B-IS1 | 6 | 0 | 1 | 2.5 kVrms | NB SOIC-16 |
| Si8460BB-A-IS1 | Si8660BB-B-IS1 | 6 | 0 | 150 | | |
| Si8461AB-A-IS1 | Si8661AB-B-IS1 | 5 | 1 | 1 | | |
| Si8461BB-A-IS1 | Si8661BB-B-IS1 | 5 | 1 | 150 | | |
| Si8462AB-A-IS1 | Si8662AB-B-IS1 | 4 | 2 | 1 | | |
| Si8462BB-A-IS1 | Si8662BB-B-IS1 | 4 | 2 | 150 | | |
| Si8463AB-A-IS1 | Si8663AB-B-IS1 | 3 | 3 | 1 | | |
| Si8463BB-A-IS1 | Si8663BB-B-IS1 | 3 | 3 | 150 | | |
| Notes: | | | | | | |
| 1. All packages are RoHS-compliant. | | | | | | |
| 2. Revision A and Revision B devices are supported for existing designs. | | | | | | |

6. Package Outline: 16-Pin Narrow Body SOIC

Figure 16 illustrates the package details for the Si846x in a 16-pin narrow-body SOIC (SO-16). Table 15 lists the values for the dimensions shown in the illustration.

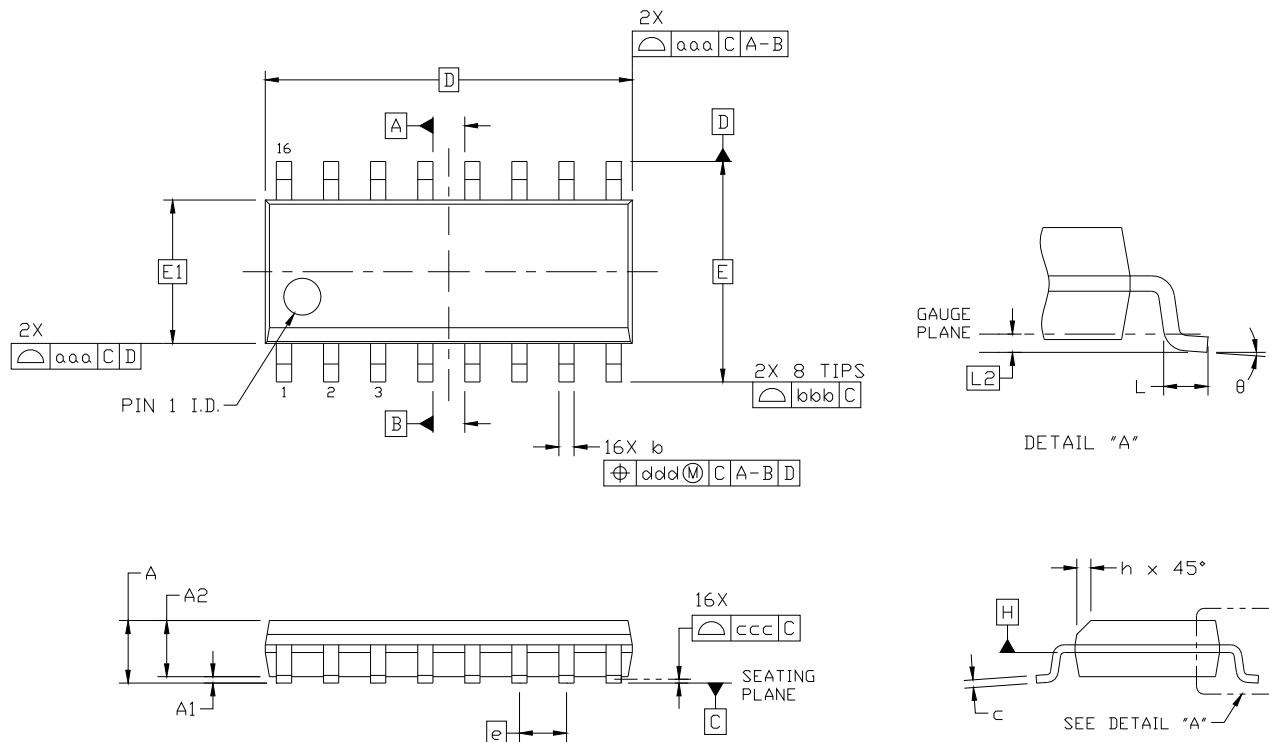

Figure 16. 16-pin Small Outline Integrated Circuit (SOIC) Package

Table 15. Package Diagram Dimensions

| Dimension | Min | Max |
|-----------|----------|------|
| A | — | 1.75 |
| A1 | 0.10 | 0.25 |
| A2 | 1.25 | — |
| b | 0.31 | 0.51 |
| c | 0.17 | 0.25 |
| D | 9.90 BSC | |
| E | 6.00 BSC | |
| E1 | 3.90 BSC | |
| e | 1.27 BSC | |
| L | 0.40 | 1.27 |
| L2 | 0.25 BSC | |

Table 15. Package Diagram Dimensions (Continued)

| Dimension | Min | Max |
|--|------|------|
| h | 0.25 | 0.50 |
| θ | 0° | 8° |
| aaa | 0.10 | |
| bbb | 0.20 | |
| ccc | 0.10 | |
| ddd | 0.25 | |
| Notes: <ol style="list-style-type: none">1. All dimensions shown are in millimeters (mm) unless otherwise noted.2. Dimensioning and Tolerancing per ANSI Y14.5M-1994.3. This drawing conforms to the JEDEC Solid State Outline MS-012, Variation AC.4. Recommended card reflow profile is per the JEDEC/IPC J-STD-020 specification for Small Body Components. | | |

Not Recommended
for New Designs

7. Land Pattern: 16-Pin Narrow Body SOIC

Figure 17 illustrates the recommended land pattern details for the Si846x in a 16-pin narrow-body SOIC. Table 16 lists the values for the dimensions shown in the illustration.

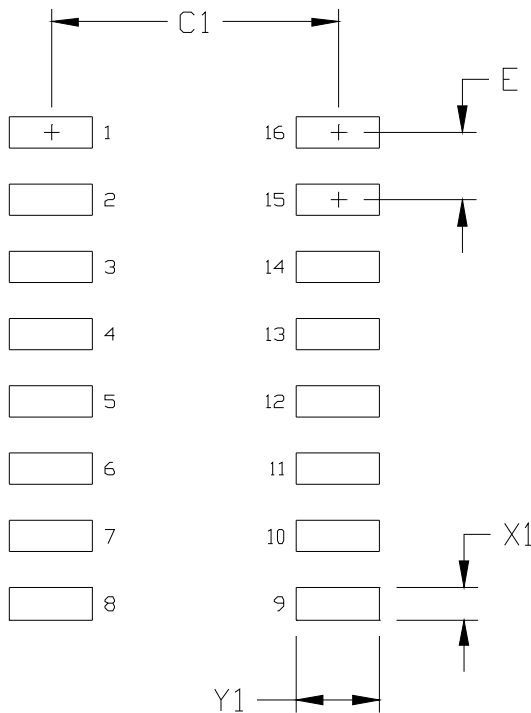

Figure 17. 16-Pin Narrow Body SOIC PCB Land Pattern

Table 16. 16-Pin Narrow Body SOIC Land Pattern Dimensions

| Dimension | Feature | (mm) |
|--|--------------------|------|
| C1 | Pad Column Spacing | 5.40 |
| E | Pad Row Pitch | 1.27 |
| X1 | Pad Width | 0.60 |
| Y1 | Pad Length | 1.55 |
| Notes: | | |
| <ol style="list-style-type: none"> 1. This Land Pattern Design is based on IPC-7351 pattern SOIC127P600X165-16N for Density Level B (Median Land Protrusion). 2. All feature sizes shown are at Maximum Material Condition (MMC) and a card fabrication tolerance of 0.05 mm is assumed. | | |

8. Top Marking: 16-Pin Narrow Body SOIC

8.1. 16-Pin Narrow Body SOIC Top Marking

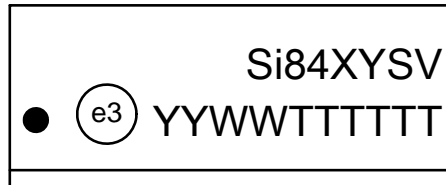

8.2. Top Marking Explanation

| | | |
|------------------------|--|---|
| Line 1 Marking: | Base Part Number Ordering Options (See Ordering Guide for more information). | Si84 = Isolator product series XY = Channel Configuration X = # of data channels (6, 5, 4, 3, 2, 1) Y = # of reverse channels (3, 2, 1, 0) S = Speed Grade A = 1 Mbps; B = 150 Mbps V = Insulation rating A = 1 kV; B = 2.5 kV |
| | Line 2 Marking: | Circle = 1.2 mm Diameter |
| | YY = Year WW = Work Week | "e3" Pb-Free Symbol |
| | TTTTTT = Mfg code | Assigned by the Assembly House. Corresponds to the year and work week of the mold date. |
| | Circle = 1.2 mm diameter | Manufacturing Code from Assembly Purchase Order form. |
| | | "e3" Pb-Free Symbol. |

Not Recommended for New Designs

DOCUMENT CHANGE LIST

Revision 0.1 to Revision 0.2

- Updated all specs to reflect latest silicon.
- Added "3. Errata and Design Migration Guidelines" on page 26.
- Added "8. Top Marking: 16-Pin Narrow Body SOIC" on page 33.

Revision 0.2 to Revision 1.0

- Updated document to reflect availability of Revision B silicon.
- Updated Tables 3,4, and 5.
 - Updated all supply currents and channel-channel skew.
- Updated Table 2.
 - Updated absolute maximum supply voltage.
- Updated Table 7.
 - Updated clearance and creepage dimensions.
- Updated "3. Errata and Design Migration Guidelines" on page 26.
- Updated "5. Ordering Guide" on page 28.

Revision 1.0 to Revision 1.1

- Updated Tables 3, 4, and 5.
 - Updated notes in tables to reflect output impedance of 85 Ω .
 - Updated rise and fall time specifications.
 - Updated CMTI value.

Revision 1.1 to Revision 1.2

- Updated document throughout to include MSL improvements to MSL2A.
- Updated "5. Ordering Guide" on page 28.
 - Updated Note 1 in ordering guide table to reflect improvement and compliance to MSL2A moisture sensitivity level.

Revision 1.2 to Revision 1.3

- Updated " Features" on page 1.
- Moved Tables 1 and 2 to page 3.
- Updated Tables 6, 7, 8, and 9.
- Updated Table 12 footnotes.
- Added Figure 15, "Si84xx Time-Dependent Dielectric Breakdown," on page 25.

Revision 1.3 to Revision 1.4

- Updated "4. Pin Descriptions" on page 27.
 - Removed note for narrow-body devices.
- Updated "2.4.1. Supply Bypass" on page 22.
- Added Figure 6, "Recommended Bypass Components for the Si84xx Digital Isolator Family," on page 22.
- Updated "3.1. Power Supply Bypass Capacitors (Revision A and Revision B)" on page 26.

Revision 1.4 to Revision 1.5

- Updated "5. Ordering Guide" on page 28 to include new title note and " Alternative Part Number (APN)" column.

Revision 1.5 to Revision 1.6

- Deleted references to MSL ratings throughout document to eliminate redundancy and maintain compliance with corporate data sheet format requirements. The MSL ratings are specified in the Qualification Report for the product.

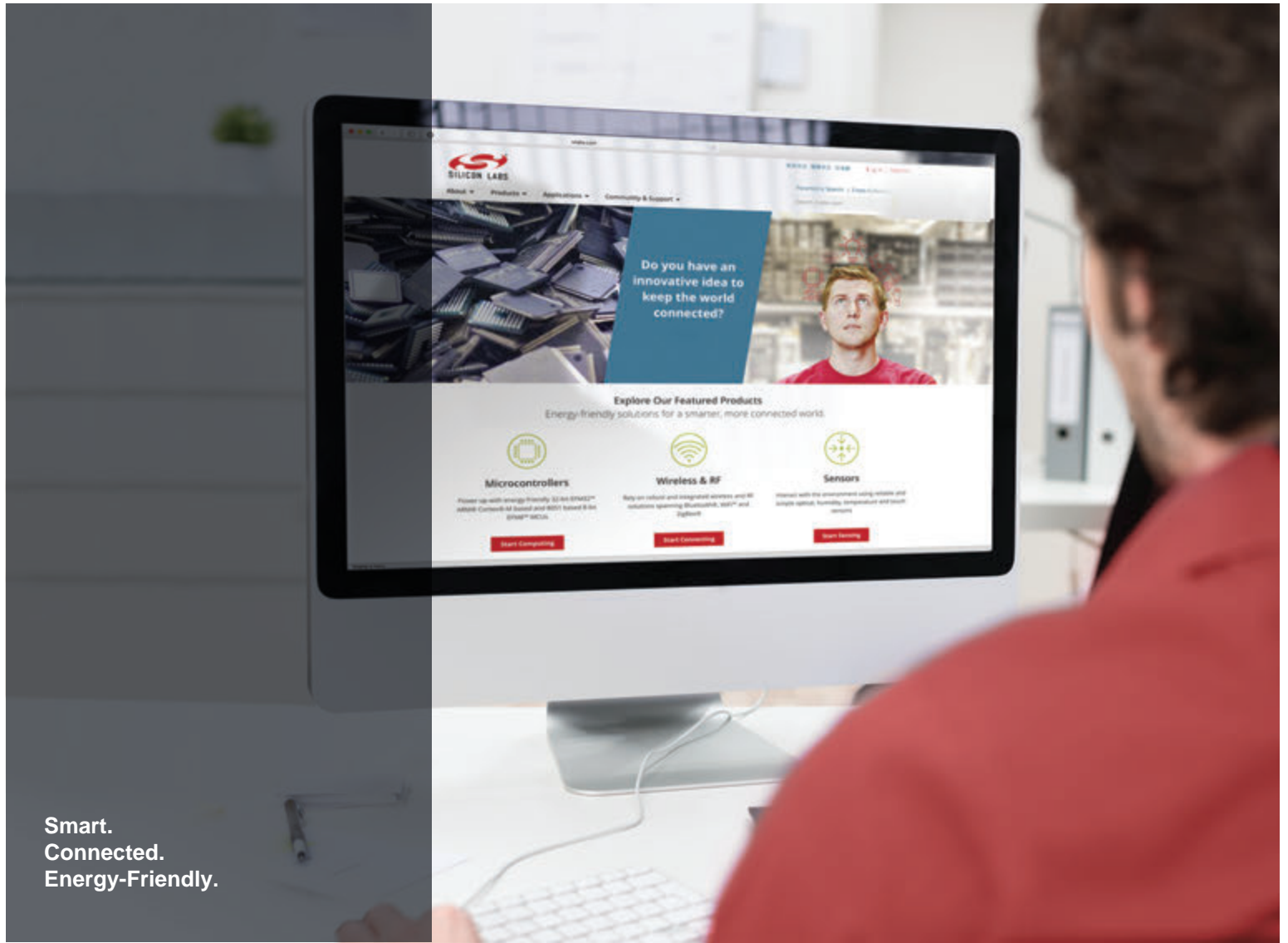

Smart.
Connected.
Energy-Friendly.



Products
www.silabs.com/products

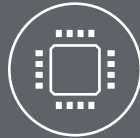

Quality
www.silabs.com/quality



Support and Community
community.silabs.com

Disclaimer
Silicon Labs intends to provide customers with the latest, accurate, and in-depth documentation of all peripherals and modules available for system and software implementers using or intending to use the Silicon Labs products. Characterization data, available modules and peripherals, memory sizes and memory addresses refer to each specific device, and "Typical" parameters provided can and do vary in different applications. Application examples described herein are for illustrative purposes only. Silicon Labs reserves the right to make changes without further notice and limitation to product information, specifications, and descriptions herein, and does not give warranties as to the accuracy or completeness of the included information. Silicon Labs shall have no liability for the consequences of use of the information supplied herein. This document does not imply or express copyright licenses granted hereunder to design or fabricate any integrated circuits. The products are not designed or authorized to be used within any Life Support System without the specific written consent of Silicon Labs. A "Life Support System" is any product or system intended to support or sustain life and/or health, which, if it fails, can be reasonably expected to result in significant personal injury or death. Silicon Labs products are not designed or authorized for military applications. Silicon Labs products shall under no circumstances be used in weapons of mass destruction including (but not limited to) nuclear, biological or chemical weapons, or missiles capable of delivering such weapons.

Trademark Information

Silicon Laboratories Inc.®, Silicon Laboratories®, Silicon Labs®, SiLabs® and the Silicon Labs logo®, Bluegiga®, Bluegiga Logo®, Clockbuilder®, CMEMS®, DSPLL®, EFM®, EFM32®, EFR®, Ember®, Energy Micro, Energy Micro logo and combinations thereof, "the world's most energy friendly microcontrollers", Ember®, EZLink®, EZRadio®, EZRadioPRO®, Gecko®, ISOModem®, Micrium, Precision32®, ProSLIC®, Simplicity Studio®, SiPHY®, Telegesis, the Telegesis Logo®, USBXpress®, Zentri and others are trademarks or registered trademarks of Silicon Labs. ARM, CORTEX, Cortex-M3 and THUMB are trademarks or registered trademarks of ARM Holdings. Keil is a registered trademark of ARM Limited. All other products or brand names mentioned herein are trademarks of their respective holders.



Silicon Laboratories Inc.
400 West Cesar Chavez
Austin, TX 78701
USA

<http://www.silabs.com>