

Part* Number	Relay Description
LD00KQ	270Vdc, 20A Solid State Relay

* The Y suffix denotes parameters tested to MIL-PRF-28750 specifications.
 The W suffix denotes parameters tested to Teledyne Specifications.

ELECTRICAL SPECIFICATIONS

(-55°C to +125°C UNLESS OTHERWISE NOTED)

INPUT (CONTROL) SPECIFICATIONS

	Min	Typ	Max	Units
Input Current @ $V_{IN} = 5$ Vdc(See Fig 2,4)			50	mA
Turn-Off Voltage (Guaranteed Off)			1.5	Vdc
Turn-On Voltage (Guaranteed On)	4.2			Vdc
Reverse Voltage Protection*			-32	Vdc
Input Supply Range (See Note 1)	4.2		18	Vdc

*Guaranteed by design but not tested

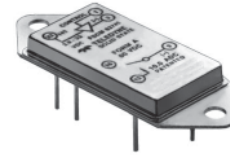

FEATURES

- High Voltage
- Low ON resistance power SiC MOSFET output
- Fast switching speed
- Meets 270 Vdc system requirements of MIL-STD-704
- Optical isolation
- Low profile hermetic package
- Built and tested to the requirements of MIL-PRF-28750

DESCRIPTION

The Series LD00KQ solid-state relays are screened utilizing MIL-PRF-28750 test methods and are packaged in low profile hermetically sealed cases. These relays are constructed with state-of-the-art solid state techniques and feature fully floating power FET output technology. This allows the load to be connected to either output terminal and provides a low ON resistance. The input and output are optically isolated to protect input logic circuits from output transients.

BLOCK DIAGRAM

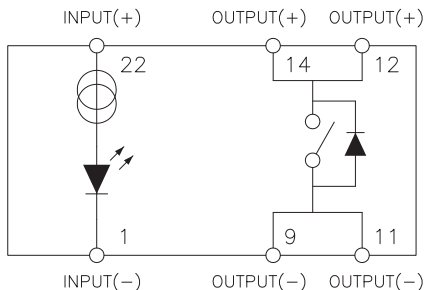

MECHANICAL SPECIFICATION

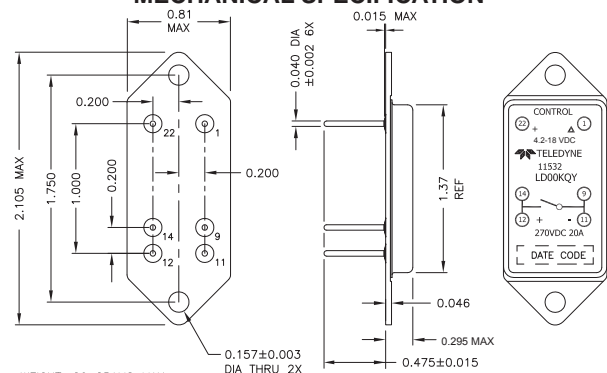

WEIGHT: 20 GRAMS MAX

TOLERANCES (UNLESS OTHERWISE SPECIFIED):

.XX = ±.010
 .XXX = ±.005

ENCLOSURE: HERMETICALLY SEALED DIP
 CAN - COLD ROLLED STEEL NICKEL PLATED
 MATERIAL HEADER - COLD ROLLED STEEL NICKEL PLATED
 PINS - COPPER CORE

OUTPUT (LOAD) SPECIFICATIONS

(See Note 2)	Min	Typ	Max	Units
Load Current without heatsink (Figure 3)			10	A dc
Load Current with heatsink (Figure 3)			20	A dc
Leakage Current @ $V_{LOAD} = 270$ Vdc			10	μ A
Output Voltage Drop @ 20A			0.5	Vdc
Continuous Operating Load Voltage			270	Vdc
Transient Blocking Voltage			500	Vdc
ON Resistance			0.025	Ohm
Turn-On Time (See Fig. 6)			7	ms
Turn-Off Time (See Fig. 6)			2	ms
Electrical System Spike @ 25°C			± 600	Vpk
Input to Output Capacitance			10	pF
Dielectric Strength	1000			Vac
Insulation Resistance @ 500 Vdc	10^9			Ohm
Output Junction Temperature			135	°C
@ $I_{LOAD} = I_{MAX RATED}$				
Thermal Resistance Junction to Ambient (θ_{JA})			30	°C/W
Thermal Resistance Junction to Case (θ_{JC})			5	°C/W

ENVIRONMENTAL SPECIFICATIONS

	Min	Typ	Max	Units
Temperature Range				
Operating	-55		+125	°C
Storage	-55		+125	°C
Vibration 100g	10		3000	Hz
Constant Acceleration			5000	g
Shock, 0.5 ms			1500	g

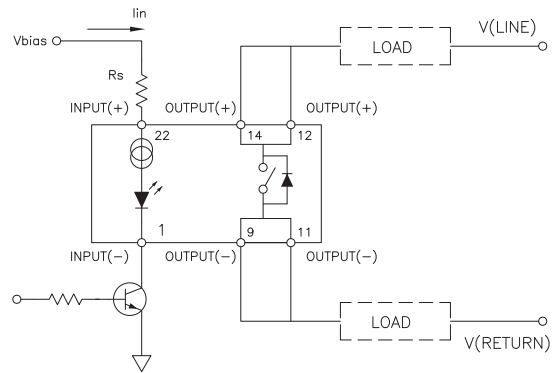

WIRING CONFIGURATIONS
 FIGURE 1
 (See Note 1)

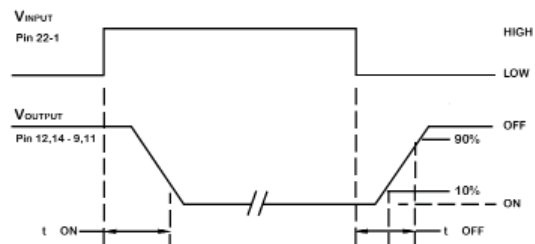

OUTPUT TURN-ON AND TURN-OFF TIMING
 FIGURE 2

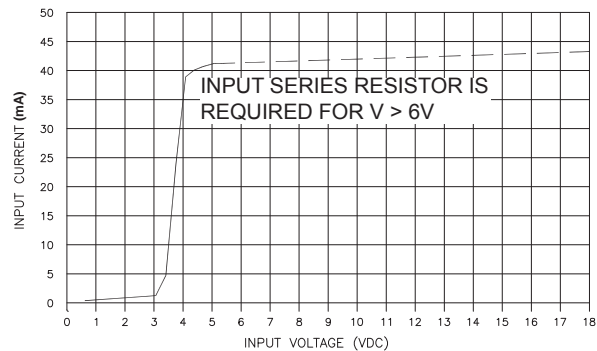

BIAS (INPUT) CURRENT VS BIAS (INPUT) VOLTAGE
 FIGURE 3
 (See Note 1)

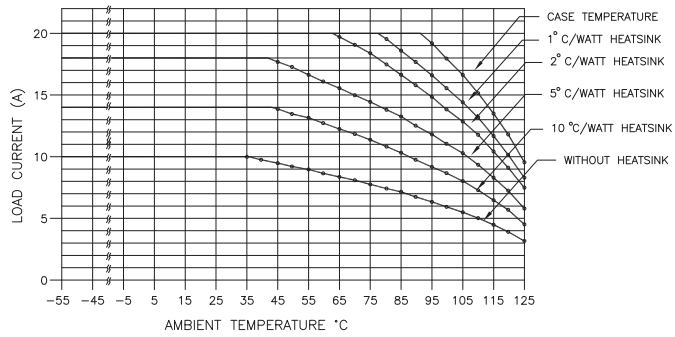

LOAD CURRENT DERATING CURVE
FIGURE 4

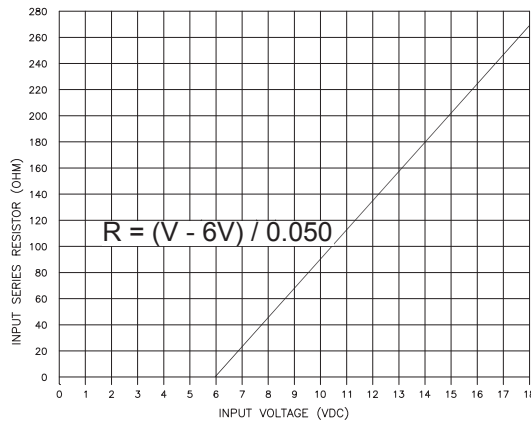

SERIES LIMIT BIAS RESISTOR VS BIAS VOLTAGE
FIGURE 5 (See Note 1)

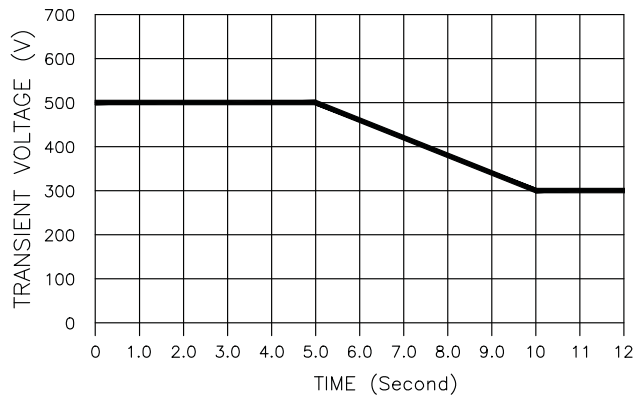

TRANSIENT VOLTAGE vs. TIME
FIGURE 6

NOTES:

1. For bias voltages above 6V, a series resistor is required. Use the standard resistor value equal to or less than the value found in Figure 4.
2. The rated input voltage is 5V for all tests unless otherwise specified.
3. Inductive loads should be diode suppressed. Input transitions should be ≤ 1 ms duration and the input drive should be a bounceless contact type.
4. Contact factory for higher voltage relays.