

D-sub Connectors

XM3-L/XM2-L/
XM4K/XM4L

The D-sub Connector Series Enters a New Era with Lead-free Products.

- Determine anchor screw diameters at a glance.
- Greatly simplified anchor combinations.
- Shielded against EMI.
- The XM3-L/XM2-L/XM4K/XM4L conform to UL standards (No. E103202) (Some models are not included)

RoHS Compliant



* Some models are not included.

■ Connectors

| Classification | D-sub Connectors | | | |
|----------------|---|---|--|---|
| Model | XM3B-L | XM2C-L | XM2E-L | XM2F-L |
| Type | Sockets with Right-angle DIP Terminals | Plugs with Right-angle DIP Terminals | Plugs with Straight DIP Terminals | Sockets with Straight DIP Terminals |
| Appearance |  |  |  |  |

| Classification | High-density D-sub Connectors | | |
|----------------|---|---|--|
| Model | XM4K | XM4L | XM4L |
| Type | Plugs with Right-angle DIP Terminals | Sockets with Right-angle DIP Terminals | Sockets with Straight DIP Terminals |
| Appearance |  |  |  |

■ Ratings and Characteristics

| | |
|-------------------------------|--|
| Rated current | 3 A |
| Rated voltage | 300 VAC |
| Contact resistance | 20 mΩ max. (at 20 mV, 100 mA max.) |
| Insulation resistance | 1,000 MΩ min. (at 500 VDC) |
| Dielectric strength | 1,000 VAC for 1 min (leakage current: 1 mA max.) |
| Insertion durability | 100 times |
| Ambient operating temperature | - 25 to 105°C (with no condensation or icing) |

■ Materials and Finish

| | | |
|-------------------|-------------|----------------------|
| Housing | | PBT (UL94 V-0)/black |
| Contact | Socket | Mating end Terminal |
| | Plug | Mating end Terminal |
| Shell | | Steel |
| Anchors | | Steel |
| Grounding Fixture | Straight | Brass/Tin plated |
| | Right angle | Brass/Nickel plated |

XM3-L/XM2-L/XM4K/XM4L D-sub Connectors

■ Ordering Information

D-sub Sockets with Right-angle DIP Terminals

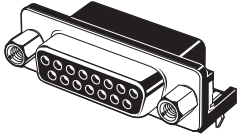
| | | | |
|------------------------|--|---|---------------------------------------|
| Appearance |  | | |
| Accessories | No anchors | Anchor 2 (XM4Z-0011) M2.6 × 0.45 | Anchor 2 (XM4Z-0013) #4-40 UNC |
| No. of contacts | | | |
| 9 | XM3B-0942-502L | XM3B-0942-112L | XM3B-0942-132L |
| 15 | XM3B-1542-502L | XM3B-1542-112L | XM3B-1542-132L |
| 25 | XM3B-2542-502L | XM3B-2542-112L | XM3B-2542-132L |

D-sub Plugs with Right-angle DIP Terminals

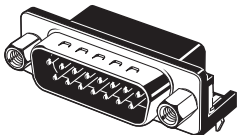
| | | | |
|------------------------|--|---|---------------------------------------|
| Appearance |  | | |
| Accessories | No anchors | Anchor 2 (XM4Z-0011) M2.6 × 0.45 | Anchor 2 (XM4Z-0013) #4-40 UNC |
| No. of contacts | | | |
| 9 | XM2C-0942-502L | XM2C-0942-112L | XM2C-0942-132L |
| 15 | XM2C-1542-502L | XM2C-1542-112L | XM2C-1542-132L |
| 25 | XM2C-2542-502L | XM2C-2542-112L | XM2C-2542-132L |

D-sub Plugs with Straight DIP Terminals

| | | | | |
|------------------------|--|-------------------|---|--|
| Appearance |  | | | |
| Accessories | No anchors Without ground pins | No anchors | Anchor 2 (XM4Z-1011) M2.6 × 0.45 | Anchor 2 (XM4Z-1013) #4- 40 UNC |
| No. of contacts | | | | |
| 9 | XM2E-0940-L | XM2E-0940-502L | XM2E-0940-112L | XM2E-0940-132L |
| 15 | XM2E-1540-L | XM2E-1540-502L | XM2E-1540-112L | XM2E-1540-132L |
| 25 | XM2E-2540-L | XM2E-2540-502L | XM2E-2540-112L | XM2E-2540-132L |

D-sub Sockets with Straight DIP Terminals

| | | | | |
|------------------------|--|-------------------|---|--|
| Appearance |  | | | |
| Accessories | No anchors Without ground pins | No anchors | Anchor 2 (XM4Z-1011) M2.6 × 0.45 | Anchor 2 (XM4Z-1013) #4- 40 UNC |
| No. of contacts | | | | |
| 9 | XM2F-0940-L | XM2F-0940-502L | XM2F-0940-112L | XM2F-0940-132L |
| 15 | XM2F-1540-L | XM2F-1540-502L | XM2F-1540-112L | XM2F-1540-132L |
| 25 | XM2F-2540-L | XM2F-2540-502L | XM2F-2540-112L | XM2F-2540-132L |

Note: For other models with Anchors, contact your OMRON representative.

High-density D-sub Plugs with Right-angle DIP Terminals

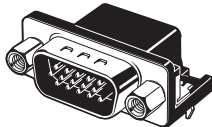
| | | | |
|-----------------|--|----------------------------------|--------------------------------|
| Appearance |  | | |
| Accessories | No anchors | Anchor 2 (XM4Z-0011) M2.6 × 0.45 | Anchor 2 (XM4Z-0013) #4-40 UNC |
| No. of contacts | | | |
| 15 | XM4K-1542-502 | XM4K-1542-112 | XM4K-1542-132 |

High-density D-sub Sockets with Right-angle DIP Terminals

| | | | |
|-----------------|--|----------------------------------|--------------------------------|
| Appearance |  | | |
| Accessories | No anchors | Anchor 2 (XM4Z-0011) M2.6 × 0.45 | Anchor 2 (XM4Z-0013) #4-40 UNC |
| No. of contacts | | | |
| 15 | XM4L-1542-502 | XM4L-1542-112 | XM4L-1542-132 |

High-density D-sub Sockets with Straight DIP Terminals

| | | | |
|-----------------|---|----------------------------------|--------------------------------|
| Appearance |  | | |
| Accessories | No anchors | Anchor 2 (XM4Z-1011) M2.6 × 0.45 | Anchor 2 (XM4Z-1013) #4-40 UNC |
| No. of contacts | | | |
| 15 | XM4L-1541-502 | XM4L-1541-112 | XM4L-1541-132 |

Note: For other models with Anchors, contact your OMRON representative.

Anchor 2 (Screw Head Length: 5.8 mm)

| Type | For right-angle DIP terminals | | | For straight DIP terminals | | |
|------------|---|---|---|--|---|---|
| Appearance |  |  |  |  |  |  |
| Lock screw | M2.6 × 0.45 | M3 × 0.5 | #4-40 UNC | M2.6 × 0.45 | M3 × 0.5 | #4-40 UNC |
| Model | XM4Z-0011 | XM4Z-0012 | XM4Z-0013 | XM4Z-1011 | XM4Z-1012 | XM4Z-1013 |

Anchor 3 (Screw Head Length: 4.8 mm)

| Type | For right-angle DIP terminals | | | For straight DIP terminals | | |
|------------|---|---|---|--|---|---|
| Appearance |  |  |  |  |  |  |
| Lock screw | M2.6 × 0.45 | M3 × 0.5 | #4-40 UNC | M2.6 × 0.45 | M3 × 0.5 | #4-40 UNC |
| Model | XM4Z-0021 | XM4Z-0022 | XM4Z-0023 | XM4Z-1021 | XM4Z-1022 | XM4Z-1023 |

■ Dimensions

(unit: mm)

D-sub Sockets with Right-angle DIP Terminals

XM3B-0942-132L
 XM3B-1542-132L
 XM3B-2542-132L

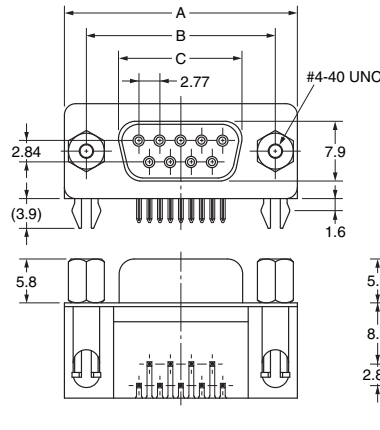
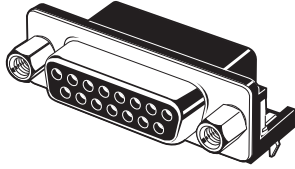

Mounting holes (t = 1.6 mm, bottom view)



Dimensions

| No. of contacts (N) | A | B | C | D |
|---------------------|------|-------|-------|------|
| 9 | 30.8 | 24.99 | 16.33 | 6.96 |
| 15 | 39.1 | 33.32 | 24.66 | 6.96 |
| 25 | 53.0 | 47.04 | 38.38 | 6.91 |

D-sub Plugs with Right-angle DIP Terminals

XM2C-0942-132L
 XM2C-1542-132L
 XM2C-2542-132L

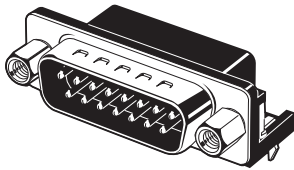

Mounting holes (t = 1.6 mm, bottom view)



Dimensions

| No. of contacts (N) | A | B | C | D |
|---------------------|------|-------|-------|------|
| 9 | 30.8 | 24.99 | 16.92 | 6.96 |
| 15 | 39.1 | 33.32 | 25.25 | 6.96 |
| 25 | 53.0 | 47.04 | 38.96 | 6.91 |

D-sub Plugs with Straight DIP Terminals

XM2E-0940-132L
 XM2E-1540-132L
 XM2E-2540-132L

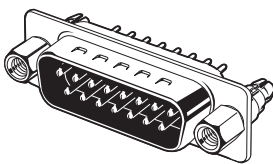

Mounting holes (t = 1.6 mm, bottom view)



Dimensions

| No. of contacts (N) | A | B | C | D | E |
|---------------------|------|-------|-------|-------|------|
| 9 | 30.8 | 24.99 | 16.92 | 19.23 | 6.96 |
| 15 | 39.1 | 33.32 | 25.25 | 27.56 | 6.96 |
| 25 | 53.0 | 47.04 | 38.96 | 41.28 | 6.91 |

D-sub Sockets with Straight DIP Terminals

(unit: mm)

XM2F-0940-132L
 XM2F-1540-132L
 XM2F-2540-132L

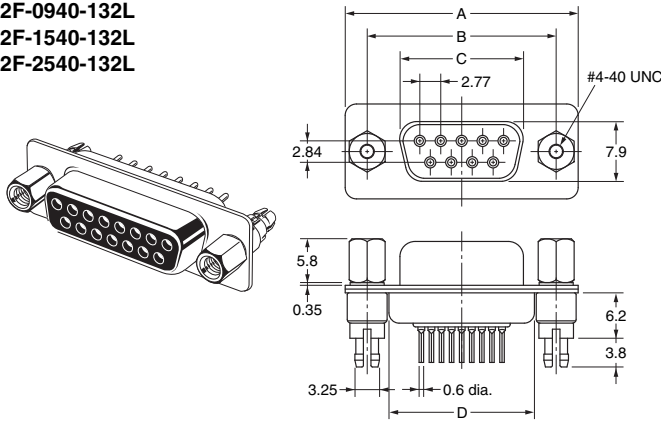

Mounting holes (t = 1.6 mm, bottom view)



Dimensions

| No. of contacts (N) | A | B | C | D | E |
|---------------------|------|-------|-------|-------|------|
| 9 | 30.8 | 24.99 | 16.33 | 19.23 | 6.96 |
| 15 | 39.1 | 33.32 | 24.66 | 27.56 | 6.96 |
| 25 | 53.0 | 47.04 | 38.38 | 41.28 | 6.91 |

High-density D-sub Plugs with Right-angle DIP Terminals

XM4K-1542-132



Mounting holes (t = 1.6 mm, bottom view)

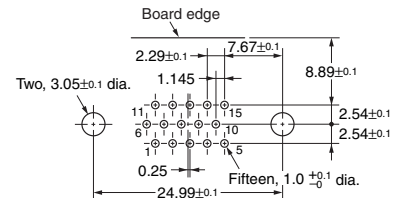

High-density D-sub Sockets with Right-angle DIP Terminals

XM4L-1542-132



Mounting holes (t = 1.6 mm, bottom view)



High-density D-sub Sockets with Straight DIP Terminals

(unit: mm)

XM4L-1541-132

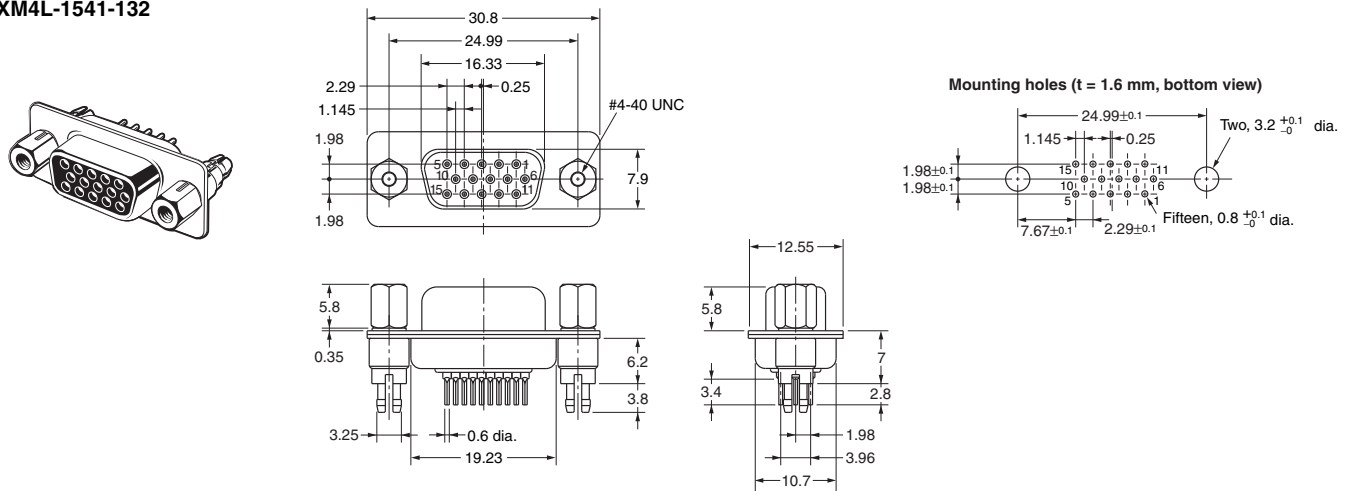

Anchor 2

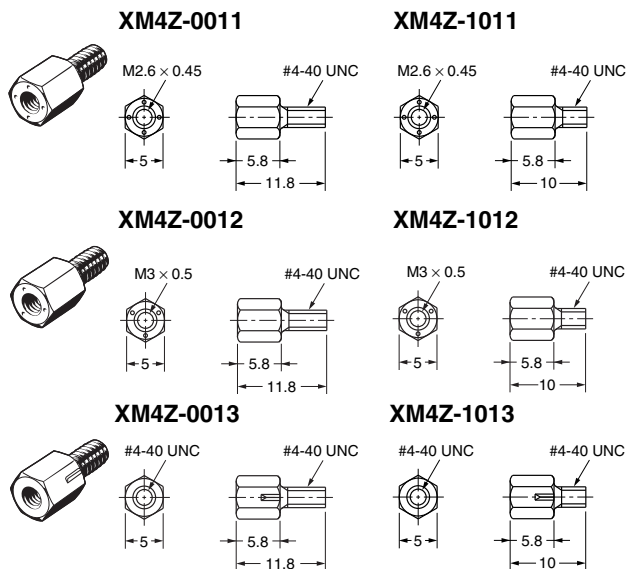

Anchor 3

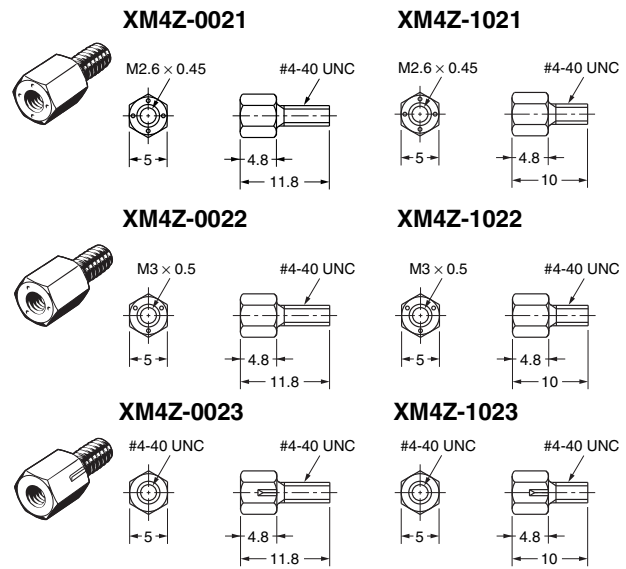

Dimensions: Not Panel Mounted (Using Anchor 2)

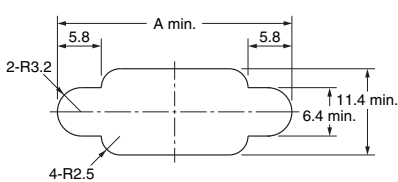

Dimensions

| No. of contacts (N) | A |
|---------------------|------|
| 9 (See note.) | 31.0 |
| 15 | 39.4 |
| 25 | 53.3 |

- Note:** 1. Two Anchors are required per Connector.
2. Applicable panel thickness is less than 1.2 mm.

Note: The XM4K and XM4L use 9-contact dimensions.

Dimensions: Panel Mounted (Using Anchor 3 or M3 Screws)

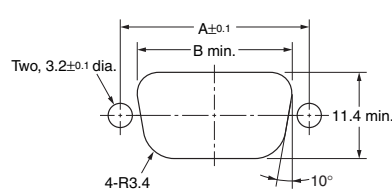

Dimensions

| No. of contacts (N) | A | B |
|---------------------|-------|------|
| 9 (See note.) | 24.99 | 20.5 |
| 15 | 33.32 | 28.8 |
| 25 | 47.04 | 42.5 |

- Note:** 1. Two Anchors are required per Connector.
2. Applicable panel thickness is less than 1.2 mm.

Note: The XM4K and XM4L use 9-contact dimensions.

Note: 2 anchors are necessary per connector.

Combination of hexagonal anchors for each connector (in post installation)

| Type | Model | Without panel insertion | With panel insertion | Commercially available nut |
|------------------------|----------------|-------------------------|----------------------|----------------------------|
| DIP Right-angle socket | XM4L-1542-502 | XM4Z-001□ | XM4Z-002□ | Not necessary |
| | XM3B-□□42-502L | | | |
| DIP Right-angle plug | XM4K-1542-502 | XM4Z-001□ | XM4Z-002□ | Not necessary |
| | XM2C-□□42-502L | | | |
| DIP straight socket | XM4L-1541-502 | XM4Z-101□ | XM4Z-102□ | Not necessary |
| | XM2F-□□40-L | | | Necessary |
| | XM2F-□□40-502L | | | Not necessary |
| DIP straight plug | XM2E-□□40-L | XM4Z-101□ | XM4Z-102□ | Necessary |
| | XM2E-□□40-502L | | | Not necessary |

■ Precautions

Correct Use

● Grounding (Lock Pin Grounding Fixture)

- To ground, provide copper foil around the Connector Attachment hole on the board, assemble the connector and grounding fixture, and dip in solder as shown below.
- Insert the connector into the PCB and then simultaneously dip-solder the connector terminals and lock pin to the board.

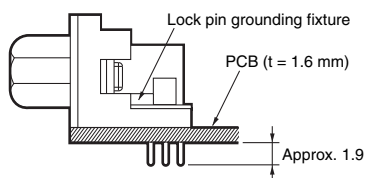

● Soldering

Automated Soldering Conditions (Jet Flow)

1. Soldering temperature: $250 \pm 5^\circ\text{C}$
2. Continuous soldering time: Within 5 ± 1 s

● Tightening Torque of Anchor and Grounding Fixture

If the anchor is secured to the connector, be sure to tighten it to a torque of 0.49 N·m.

Also, use a proper size tool to do this work.

● Mating

Do not connect the Connectors in the wrong direction, otherwise it may be damaged.

- Application examples provided in this document are for reference only. In actual applications, confirm equipment functions and safety before using the product.
- Consult your OMRON representative before using the product under conditions which are not described in the manual or applying the product to nuclear control systems, railroad systems, aviation systems, vehicles, combustion systems, medical equipment, amusement machines, safety equipment, and other systems or equipment that may have a serious influence on lives and property if used improperly. Make sure that the ratings and performance characteristics of the product provide a margin of safety for the system or equipment, and be sure to provide the system or equipment with double safety mechanisms.

Note: Do not use this document to operate the Unit.

OMRON Corporation

Electronic and Mechanical Components Company

Contact: www.omron.com/ecb

Cat. No. G060-E1-02
1014(0412)(O)