

Powered by



EVX 12520 ▶ 12V 52Ah

EVX 12520 is designed specially for electric vehicles, such as electric golf cart, electric wheelchair, mower, dust collector...etc. It has high cycling life, high efficiency and long service life.



► Specification

Cells Per Unit	6
Voltage Per Unit	12
Capacity	52Ah @ 20hr-rate to 1.75V per cell @25 °C (77°F)
Weight	Approx. 18.3 kg (40.35 lbs)
Maximum Discharge Current	500A(5sec)
Internal Resistance	Approx. 5.5 mΩ
Operating Temperature Range	Discharge: -15°C~50°C (5°F~122°F) Charge: -15 °C~40°C (5°F~104°F) Storage: -15°C~40°C (5°F~104°F)
Nominal Operating Temperature Range	25°C±3°C (77°F±5°F)
Float Charging Voltage	13.5 to 13.8 VDC/unit Average at 25°C (77°F)
Recommended Maximum Charging Current Limit	15.6 A
Equalization and Cycle Service	14.4 to 15.0 VDC/unit Average at 25°C (77°F)
Self Discharge	CSB Batteries can be stored for more than 6 months at 25°C (77°F). Please charge batteries before using. For higher temperatures the time interval will be shorter.
Terminal	B4-L terminal to accept M6 nut & bolt
Container Material	Polypropylene(UL 94-HB) & Flammability resistance of (UL 94-V0) can be available upon request.



CSB-manufactured **VRLA** (Absorbent **G**lass **M**at type) batteries are UL-recognized components under UL1989.

CSB is also certified by ISO 9001 and ISO 14001.

► Dimensions :

Unit: mm (inch)	Overall Height (H)	Container height (h)	Length (L)	Width (W)
	219.3±2.0 (8.63±0.08)	201.3±2.0 (7.93±0.08)	248.0±2.0 (9.76±0.08)	138.4±1.5 (5.45±0.06)

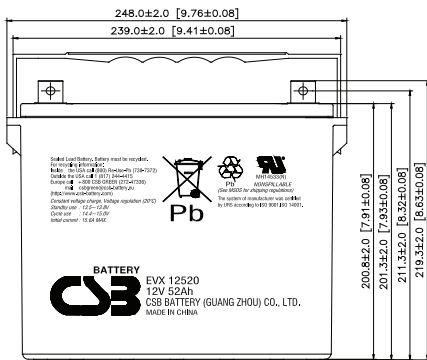

A Detail Drawing

B4

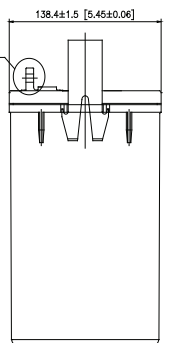
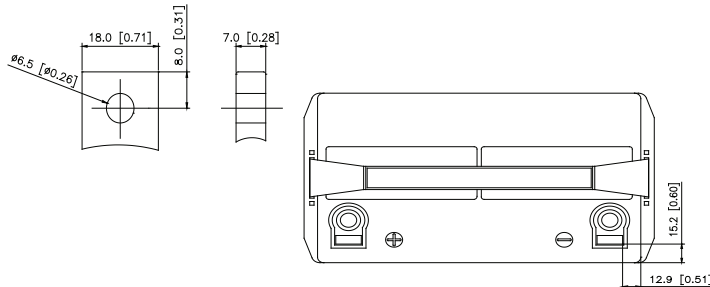

Constant Current Discharge Characteristics Unit:A (25°C ,77°F)

F.V/Time	30MIN	60MIN	90MIN	2HR	3HR	4HR	5HR	8HR	10HR	20HR
1.60V	64.9	36.8	27.0	21.0	14.8	11.7	9.60	6.60	5.42	2.84
1.67V	63.5	36.4	26.8	20.8	14.6	11.6	9.52	6.52	5.36	2.80
1.70V	62.1	35.8	26.5	20.6	14.5	11.5	9.45	6.45	5.29	2.76
1.75V	60.6	35.2	26.1	20.3	14.3	11.4	9.37	6.34	5.21	2.72
1.80V	59.2	34.7	25.6	20.1	14.2	11.3	9.26	6.22	5.12	2.68
1.85V	57.8	34.2	25.1	19.9	14.1	11.2	9.16	6.11	5.03	2.62

Constant Power Discharge Characteristics Unit:W (25°C ,77°F)

F.V/Time	30MIN	60MIN	90MIN	2HR	3HR	4HR	5HR	8HR	10HR	20HR
1.60V	668	386	284	221	154	124	102	70.9	58.7	33.6
1.67V	656	382	281	219	153	123	101	70.2	58.1	33.1
1.70V	645	378	277	217	152	122	100	69.4	57.4	32.5
1.75V	631	372	273	214	151	121	99.0	68.6	56.7	31.8
1.80V	615	368	269	212	150	120	98.1	67.6	55.8	31.1
1.85V	598	363	264	209	149	119	97.0	66.1	54.8	30.4

Ratings presented herein are subject to revision without notice. Please refer to www.csb-battery.com to confirm the latest version.

Trickle (or Float) Service Life

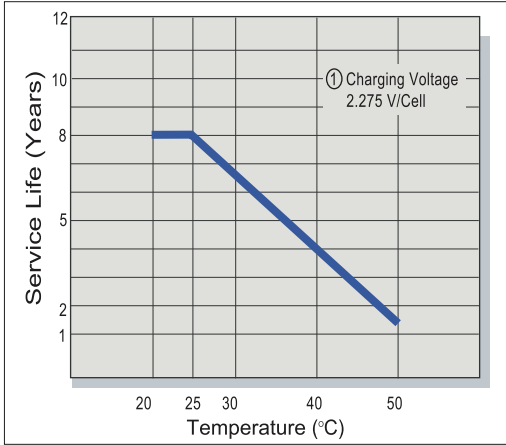

Capacity Retention Characteristic

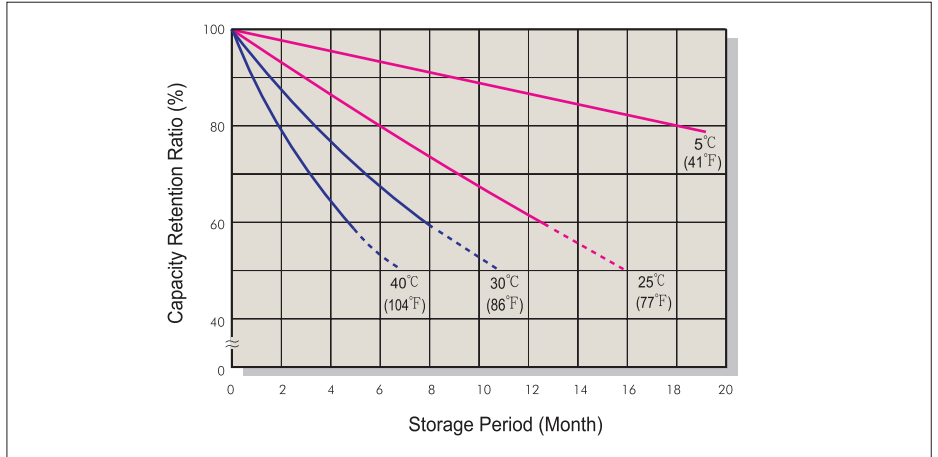

Battery Voltage and Charge Time for Standby Use

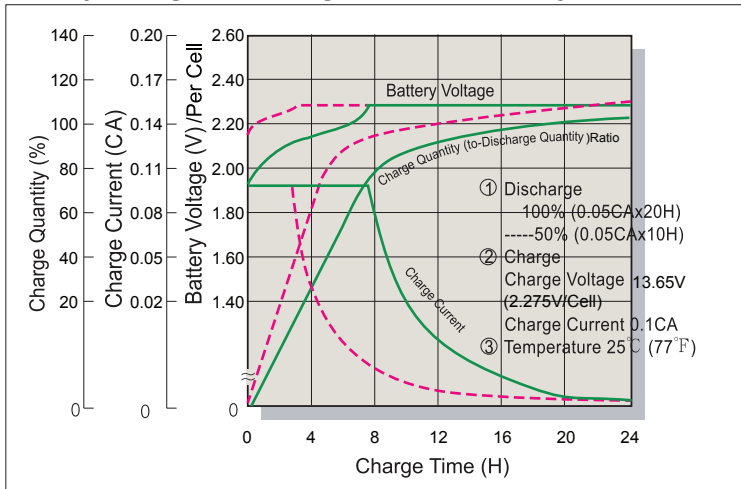

Series Cycle Service Life

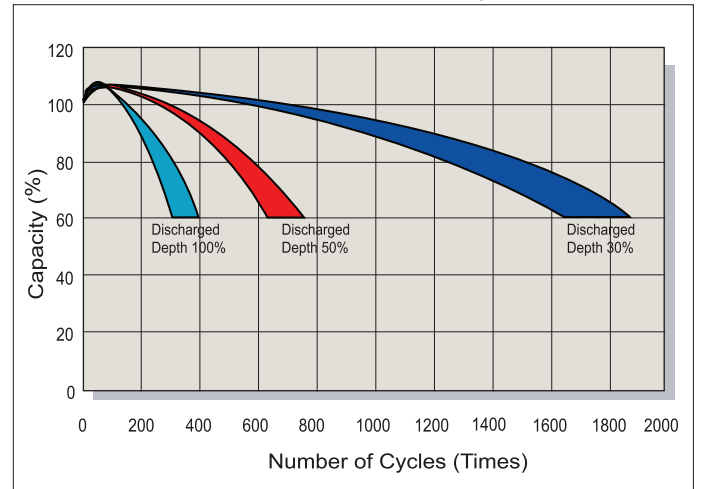

Battery Voltage and Charge Time for Cycle Use

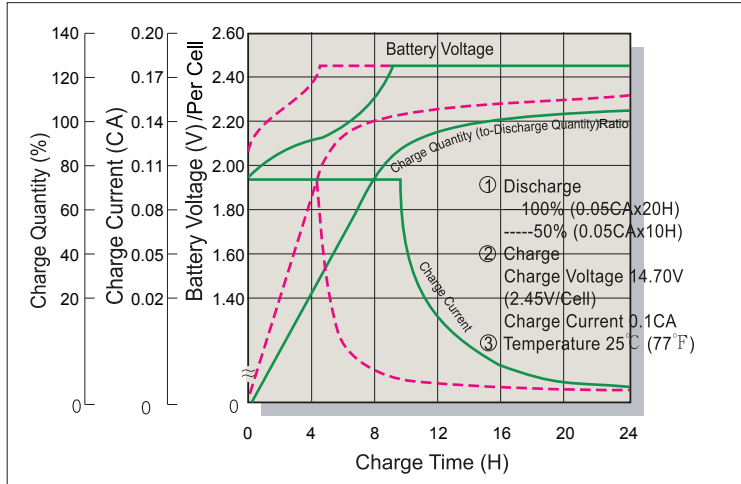

Terminal Voltage (V) and Discharge Time

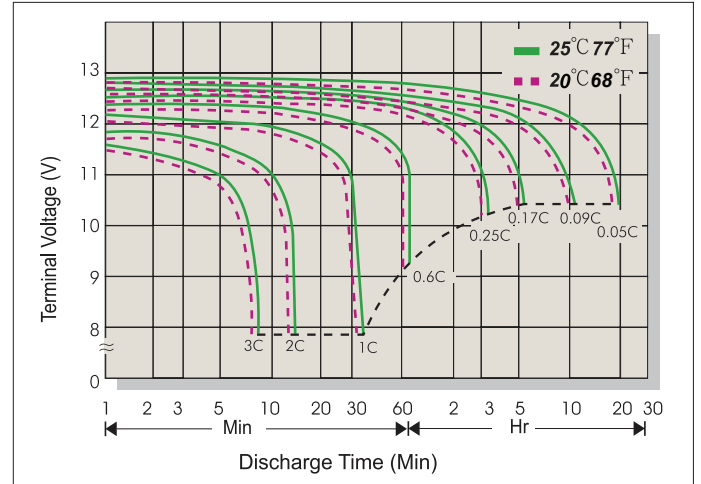

Charging Procedures

Application	Charge Voltage(V/Cell)			Max.Charge Current
	Temperature	Set Point	Allowable Range	
Cycle Use	25°C(77°F)	2.45	2.40~2.50	0.3C
Standby	25°C(77°F)	2.275	2.25~2.30	

Discharge Current VS. Discharge Voltage

Final Discharge Voltage V/Cell	1.75	1.70	1.60	1.30
Discharge Current(A)	0.2C>(A)	0.2C<(A)<0.5C	0.5C<(A)<1.0C	(A)>1.0C

Sales Office URL: WWW.CSB-BATTERY.COM

GLOBAL HQ
CSB BATTERY CO., LTD. (TAIWAN)
 Tel : +886-2-2880-5600
 Fax : +886-2-2888-3300
 mail : service@csb-battery.com.tw

BEIJING OFFICE. (CHINA)
CSB BATTERY TECHNOLOGIES (BEIJING) CO., LTD.
 Tel : +86-10-5820-5336/5338
 Fax : +86-10-58203053
 mail : chinasl@csb-battery.com

AMERICA HQ
CSB BATTERY TECHNOLOGIES INC. (U.S.A)
 Tel : +1-817-244-7777/1-(800)3-CSB-USA(272872)
 Fax : +1-817-244-4445
 mail : csb@csb-battery.com

SHANGHAI OFFICE. (CHINA)
CSB BATTERY LOGISTIC (SHANGHAI) CO., LTD.
 Tel : +86-21-5046-1622/5046-0833
 Fax : +86-21-5064-1046
 mail : chinasl@csb-battery.com

EUROPE HQ
CSB Battery Europe BV.
 Tel : +31(0)-180-418-140
 Fax : +31(0)-180-418-327
 mail : eurosales@csb-battery.eu

SHENZHEN OFFICE. (CHINA)
CSB BATTERY LOGISTIC (SHANGHAI) CO., LTD.
 Tel : +86-755-8831-6488/6396/6356
 Fax : +86-755-8831-6548
 mail : she@csb-battery.com.cn