



AURIX™ 32-bit microcontrollers for automotive and industrial applications

Highly integrated and performance optimized

Issue 2020

www.infineon.com/aurix



Contents

TriCore™ family concept	3	AURIX™ for powertrain applications	36
Evolution of TriCore™ generations	4	AURIX™ for xEV applications	43
TriCore™ based product roadmap	5	AURIX™ for safety applications	48
AURIX™ product selector	6	AURIX™ for connectivity applications	61
PRO-SIL™ safety concept	7	AURIX™ for transportation applications	67
AURIX™ family housing options	8	AURIX™ for industrial applications	75
AURIX™ family system architecture	9	Tool partners	85
Peripheral highlights	14		
AURIX™ security features	18		
Embedded software (AUTOSAR etc.)	21		
Development support	23		
Multicore software development with AURIX™	24		
Kits and evaluation boards	25		
Ease of use	29		
AURIX™ solution finder	29		
AURIX™ forum	30		
Artificial intelligence in AURIX™ TC3xx	31		
AURIX™ Development Studio	32		
AURIX™ and XMC™ PDH partners	33		



Family highlights

- › Compatibility and scalability
- › Lowest system cost
- › Industry benchmark system performance
- › Easy to use
- › Broad portfolio
- › Certified to automotive standards

Powertrain



Applications

- › Powertrain domain controller
- › Gasoline direct injection
- › Gasoline multi-port injection
- › Diesel direct injection
- › Automatic transmission
- › Transfer case/torque vectoring

xEV



Applications

- › Battery management
- › Off-board charging
- › Charging station
- › Inverter
- › Low-voltage DC-DC
- › High-voltage DC-DC

Safety



Applications

- › Chassis domain control
- › Electric Power Steering (EPS)
- › Active suspension control system
- › Advanced airbag system
- › Braking ECU
- › Multi-purpose camera configuration
- › Short-range radar (24/60 GHz) system
- › Long-range radar (76/77 GHz) system
- › LIDAR systems
- › LED pixel lighting
- › Sensor fusion
- › eHorizon

Connectivity



Applications

- › Body domain controller
- › Connected gateway
- › Advanced body applications
- › Pixel lighting
- › In-vehicle wireless charger
- › Telematics
- › V2x communication

Transportation



Applications

- › Commercial and Agricultural Vehicle (CAV)
- › Fun vehicle
- › Transportation
- › Trucks
- › Drones
- › Avionics

Industrial & Multimarket



Applications

- › Mobile controller
- › Inverter
- › Wind turbine inverter
- › Servo drives
- › Solar panel
- › Robotics
- › Medical
- › Elevator



Evolution of TriCore™ generations

In 1999, Infineon launched the first generation of the AUDO (AUtomotive unifieD processOr) family. Based on a unified RISC/MCU/DSP processor core, this 32-bit TriCore™ micro-controller was a computational power horse. And the company has evolved and optimized the concept ever since – culminating in what is now the sixth TriCore™ generation.

peripheral sets, frequencies, temperatures and packaging options. And all this with a high degree of compatibility across generations.

The TriCore™ success story continues with the AURIX™ TC2xx multicore family. AURIX™ combines easy-to-use



Thanks to its high real-time performance, embedded safety and security features, the TriCore™ family is the ideal platform for a wide range of automotive applications. These include powertrain engine management and transmission, electric and hybrid vehicles, chassis domains, braking systems, electric power steering systems, airbags, connectivity and advanced driver assistance systems to support the trend toward autonomous, clean and connected cars. TriCore™-based products also deliver the versatility required for the industrial, CAV and transportation sector, excelling in optimized motor control applications and signal processing. Infineon's broad product portfolio allows engineers to choose from a wide range of memories,

functional safety support, strong performance and a future-proven security solution in a highly scalable product family.

The next natural evolution in terms of performance is the AURIX™ TC3xx, which is manufactured in 40 nm embedded flash technology and designed for ultimate reliability in harsh automotive environments. As before with AURIX™, the dual frontend concept ensures continuous supply. An extensive ecosystem is available including the AUTOSAR libraries which Infineon has been developing since 2005. Plus the safety software is also available to help manufacturers meet SIL/ASIL safety standards.

TriCore™ based product roadmap

Segment	Production		Development
	AUDO family	AURIX™ TC2xx	AURIX™ TC3xx
	90 nm	65 nm	40 nm
High end	TC1798 300 MHz, 4 MB		TC39xA 6x 300 MHz, 16 MB
		TC29xTX 3x 300 MHz, 8 MB	TC39XX 6x 300 MHz, 16 MB
		TC29xTP 3x 300 MHz, 8 MB	TC39XP 6x 300 MHz, 16 MB
		TC27xTP 3x 200 MHz, 4 MB	TC3E7Qx 4x 300 MHz, 12 MB
	TC1793 270 MHz, 4 MB		TC38xQP 4x 300 MHz, 10 MB
	TC1791 240 MHz, 4 MB		TC37xTX 3x 300 MHz, 6 MB
		TC37xTP 3x 300 MHz, 6 MB	
Mid range			TC3AxQA 3x 300 MHz, 4 MB
	TC1784 180 MHz, 2.5 MB	TC26xD 2x 200 MHz, 2.5 MB	TC357TA 3x 300 MHz, 4 MB
	TC1782 180 MHz, 2.5 MB		TC36xDP 2x 300 MHz, 4 MB
Low end	TC1728 133 MHz, 1.5 MB	TC23xLX 200 MHz, 2 MB	TC33xDA 2x 200 MHz, 2 MB
	TC1724 80 MHz, 1.5 MB	TC23xLP 200 MHz, 2 MB	TC33xLP 200 MHz, 2 MB
		TC22xL 133 MHz, 1 MB	
		TC21xL 133 MHz, 0.5 MB	TC32x 160 MHz, 1 MB
Companion chips		TLF35584	TLF35584 TLF30684

 AURIX™ 1st generation

 AURIX™ 2nd generation

AURIX™ product selector

AURIX™ TC3xx family product naming system



AURIX™ TC2xx family product naming system



Infineon PRO-SIL™



The functional complexity and levels of integration of real-time, safety-critical applications continue to increase. Safety standards such as IEC 61508 and ISO 26262, mandate more robust products and functional safety concepts in automotive and industrial applications.

Infineon's PRO-SIL™ trademark designates the Infineon products that contain SIL-supporting (Safety Integrity Level) features. The purpose of SIL-supporting features involves assisting the overall system design in attaining the desired SIL (according to IEC 61508) or ASIL (according to ISO 26262) level for safety systems with high efficiency. Products with the PRO-SIL™ label will help you to select Infineon products.



PRO-SIL™ highlights

- › Broad hardware portfolio, including sensors and micro-controllers, along with analog and power management ICs that provide SIL-supporting features
- › An independent functional safety management organization supports the ISO 26262 safety lifecycle
- › Safety documentation, such as a safety manual and safety analysis summary report, can be made available for dedicated PRO-SIL™ products (NDA may be required)
- › Infineon offers expert system integrator support for achieving the required ASIL on system level
- › Infineon's PRO-SIL™ logo will guide you to our products (hardware, software, safety documentation) with SIL-supporting features. Infineon's activities result in simplified integration in safety-related applications.



Infineon quality management system
Zero Defect culture



AURIX™ family housing options

Package information for maximum scalability



TriCore™ upgrade paths



› LFBGA-292 and LFBGA-516 are ball compatible so that customers can build one PCB for both packages

AURIX™ TC2xx family system architecture

Powerful 1st generation AURIX™ TC2xx system architecture

AURIX™ is Infineon's current family of microcontrollers that serve the precise needs of the automotive industry in terms of performance and safety. Its innovative multicore architecture, based on up to three independent 32-bit TriCore™ CPUs, has been designed to meet the highest safety standards, while simultaneously increasing performance significantly.

Using the AURIX™ platform, automotive developers will be able to control powertrain and safety applications with one single MCU platform. Developments using AURIX™ will require less effort to achieve the ASIL-D standard than with a classical lockstep architecture.

Customers wanting to reduce their time-to-market can now cut down their MCU safety development by 30%. By the same token, a performance surplus of 50% up to 100% allows for more functionality and offers a sufficient resource buffer for future requirements, keeping the power consumption on the single-core microcontroller level. While protecting IP, and preventing theft and fraud, AURIX™ provides an already built-in hardware security module.

Thanks to its special feature set, AURIX™ is the perfect match for powertrain applications (including hybrid and electrical vehicles) as well as safety applications (such as steering, braking, airbag and advanced driver assistance systems).

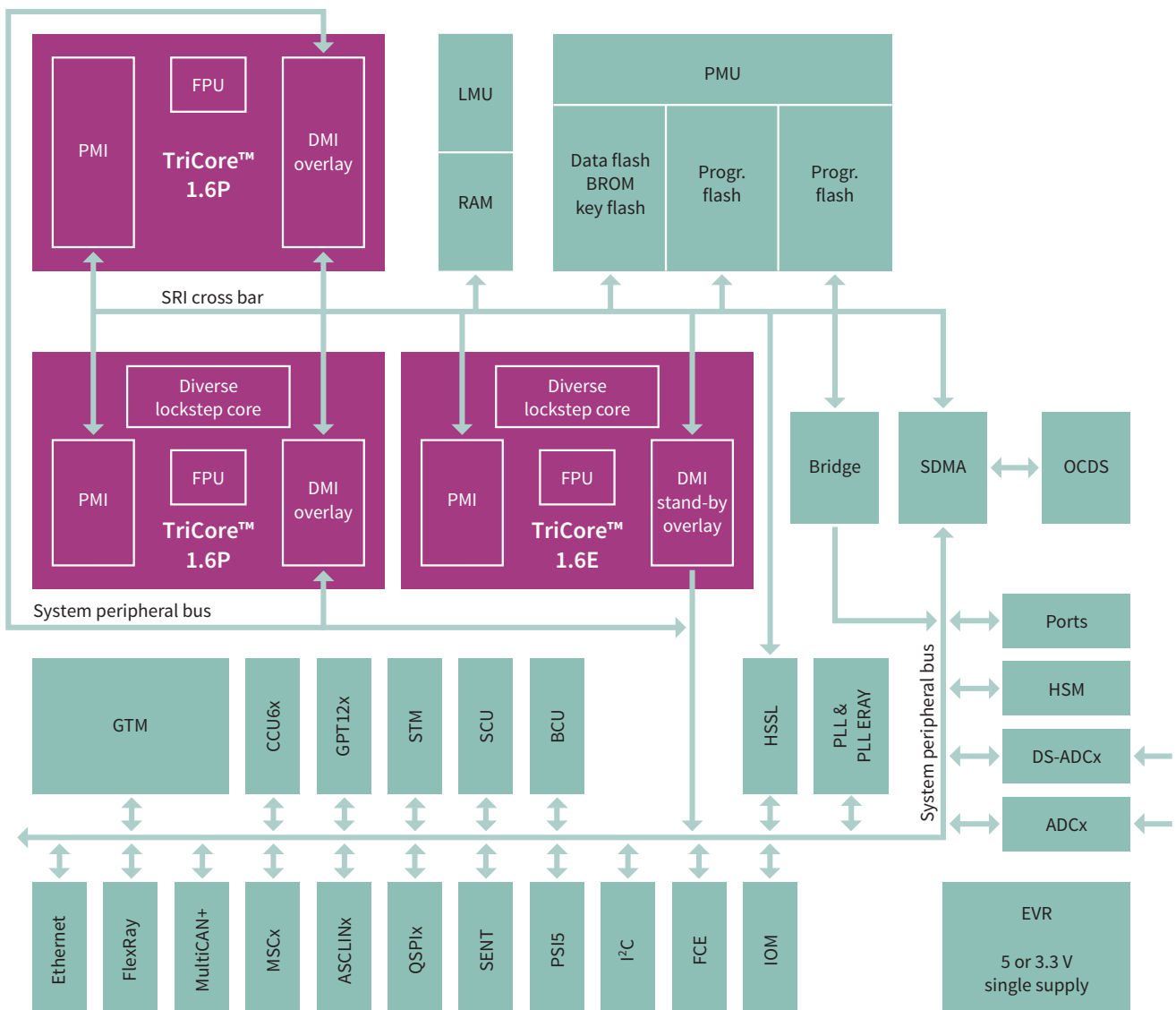

AURIX™ TC2xx family system architecture

AURIX™ TC2xx family package scalability

9x Series up to 8 MB					TC297 300 MHz	TC298 300 MHz	TC299 300 MHz
7x Series up to 4 MB				TC275 200 MHz	TC277 200 MHz		
6x Series up to 2.5 MB			TC264 200 MHz	TC265 200 MHz	TC267 200 MHz		
3x Series up to 2 MB		TC233 200 MHz	TC234 200 MHz		TC237 200 MHz		
2x Series up to 1 MB	TC222 133 MHz	TC223 133 MHz	TC224 133 MHz				
1x Series up to 512 KB	TC212 133 MHz	TC213 133 MHz	TC214 133 MHz				
Flash Package	TQFP-80	TQFP-100	TQFP-144 LQFP-144	LQFP-176	LFBGA-292	BGA-416	LFBGA-516

↕ Upgrade/downgrade with pin-compatible packages

- › The LFBGA-516 package is a superset of the LFBGA-292
- › Combination PCBs can be designed for I/O and feature upgrades
- › Advanced package technologies deliver the best price/performance ratio
- › Customers can choose between different devices in the same pin-compatible package

Evolution from TC2xx to TC3xx – easy migration with focus on reuse

- › Fast conversion of existing AURIX™ TC2xx designs
 - Backwards compatibility
 - High AURIX™ family compatibility to pinout of existing QFP-100/144/176 and BGA packages
- › Flexibility – scalability within the AURIX™ family
 - Up-/downgrade paths for devices in identical packages
 - Compatible pin-out of QFP/BGA package options enabling combi designs
- › High pin to pin compability between the AURIX™ TC2xx/TC3xx generation
- › A high scalability with a very large portfolio for both AURIX™ TC2xx & TC3xx.

AURIX™ TC3xx provides an upgrade on key parameters with focus on SW & HW reuse

	Performance increase & reduction of power	Increased from 3 to 6 cores Developed in 40 nm for power consumption reduction
	Scalable & backwards compatible to TC2xx	Fully compatible devices with focus on HW & SW reuse
	Functional safety	ISO 26262 compliant enabling ASIL-D level
	Enhanced security	Upgraded to Full EVITA support
	Improved networking	Richer peripheral set
	SOTA	Full support of SOTA A/B swap

AURIX™ TC3xx family system architecture

Scalable 2nd generation AURIX™ TC3xx system architecture

The latest AURIX™ TC3xx microcontrollers are also well-suited for safety-critical applications to support clean, autonomous and connected cars. Ranging from classic airbag, braking and power steering to fail-operational systems supported by sensor-based systems using radar, LIDAR or camera technologies.

The implemented connectivity features, in combination with the highest level of security, enable connected cars with applications such as a telematics unit, connected gateway or in-vehicle wireless charging for portable devices.

To make the car clean, the new family is well-suited to new systems in electrical and hybrid drives – specifically hybrid domain control, inverter control, battery management, on-board charger and DC-DC converters, in addition to engine management and transmission control systems.

The AURIX™ TC3xx combines performance with a powerful safety architecture and offers enhanced security with the second-generation HSM with asymmetric cryptography accelerators and Full EVITA support. This combination makes the family the ideal fit for domain control and data fusion applications supporting the next levels of autonomous driving.

The AURIX™ TC3xx family is pin compatible with the AURIX™ TC2xx family and offers increased flash memory sizes of up to 16 MByte, over 6 MByte of integrated RAM and up to six TriCore™ 1.62 embedded cores, each with a full clock frequency of 300 MHz. New features include a new radar processing sub-system with up to two dedicated Signal Processing Units (SPU), Gigabit Ethernet, additional CAN FD and LIN interfaces and an eMMC interface for external flash.

AURIX™ TC3xx – scalable family – from low-cost to high-performance applications



AURIX™ TC3xx package scalability

6x 300 MHz	9xA Series 16 MB							TC397XA 300 MHz	
6x 300 MHz	9x Series 16 MB	Control and Actuate Sense and Compute						TC397X 300 MHz	TC399X 300 MHz
4x 300 MHz	Ex Series 12 MB							TC3E7Qx 300 MHz	
4x 300 MHz	8x Series 10 MB							TC387Q 300 MHz	TC389Q 300 MHz
3x 300 MHz	7xX Series 6 MB							TC377TX 300 MHz	
3x 300 MHz	7x Series 6 MB					TC375T 300 MHz		TC377T 300 MHz	
2x 300 MHz	6x Series 4 MB			TC364D 300 MHz	TC366D 300 MHz	TC365D 300 MHz		TC367D 300 MHz	
4x 300 MHz	Ax Series 4 MB						TC3A8Q 300 MHz	TC3A7Q 300 MHz	
3x 300 MHz	5xA Series 4 MB				TC356TA 300 MHz			TC357TA 300 MHz	
2x 300 MHz	3xA Series 2 MB				TC336DA 300 MHz			TC337DA 300 MHz	
1x 300 MHz	3x Series 2 MB	TC332L 300 MHz	TC333L 300 MHz	TC334L 300 MHz	TC336L 300 MHz			TC337L 300 MHz	
1x 160 MHz	2x Series 1 MB	TC322L 160 MHz	TC323L 160 MHz	TC324L 160 MHz				TC327L 160 MHz	
Flash	Package	TQFP-80	TQFP-100	LQFP-144 TQFP-144	BGA-180	LQFP-176	BGA-233	LFBGA-292	LFBGA-516

- › Advanced package technologies deliver the best price/performance ratio
- › Customers can choose between different devices in the same pin-compatible package

MCU scalability

- › Performance and flash
- › Pin compatibility
- › Binary-compatible cores

Safety/security concept

- › ISO 26262 compliance
- › Hardware security support Full EVITA
- › IEC 61508 compliant



AURIX™ TC3xx

Power consumption

- › On-chip SC DC-DC high-efficiency power supply
- › Integrated stand-by controller

Connectivity

- › Ethernet: up to 2x 1 GB
- › CAN FD: up to 20 channels
- › LIN: up to 24 channels
- › eMMC IF

Peripheral highlights

Multi-AUTOSAR OS support on one microcontroller

- > AURIX™ provides a memory protection system for each core plus an additional distributed hardware-based resource management system
- > Each peripheral and shared SRAM has a resource management unit that works as a local access protection mechanism to grant or deny access
- > When combined with the memory protection system, this hardware can be used to prevent selected direct access from certain tasks or cores to peripherals or regions of SRAMs and instead redirect the attempted access to a hypervisor function
- > The hypervisor can arbitrate/grant/deny access and therefore provide paravirtualization of mixed-criticality tasks in a unified sub-system architecture with a minimal CPU overhead
- > AURIX™ therefore provides the ability to run mixed-criticality software requiring real-time access while still enforcing encapsulation and freedom of interference between cores, even when the cores are not running time and memory-protected operating systems

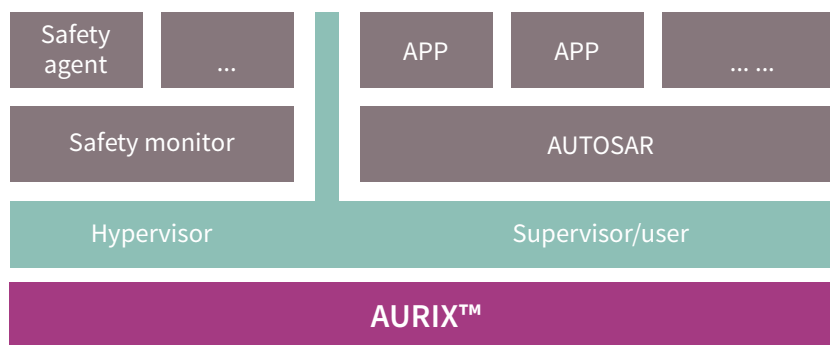

AURIX™ protection system overview

- > Hardware support for freedom of interference
 - Between software components
 - Between hardware parts
 - Between hardware parts and software components
- > Timing protection



Infineon® diverse lockstep concept

- › Lockstep architecture designed to control and mitigate common cause factors
 - Physical isolation
 - Instruction-level execution diversity: 2-cycle delay
 - Circuit-level design and timing diversity
- › Layout-level diversity
- › Diversity controlled and verified by state-of-the-art design methods
- › Special design of clock and reset networks
- › Careful design of lockstep comparator
- › Main core and diverse lockstep core run the same software in parallel to detect computational errors
- › Like normal locksteps, both cores are physically separated and have a time delay between their execution
- › Diverse lockstep core has been additionally transformed to provide architectural hardware diversity and further reduce common cause failures

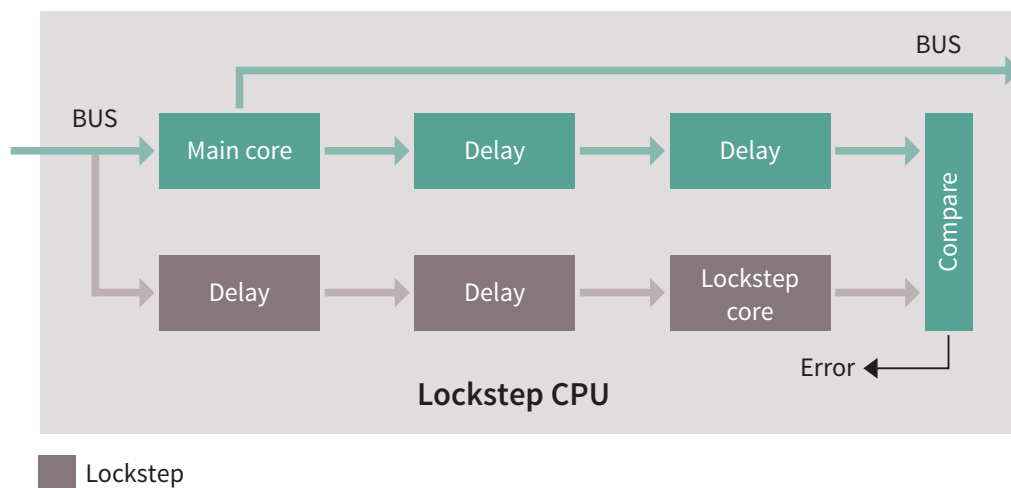

AURIX™ family communication innovation

AURIX™ Multi-CAN/CAN FD

- › Up to 20 CAN nodes with FD support available
- › CAN standard V2.0 B active
- › AURIX™ family support ISO 11898-1 DIS 2015
- › Resonator ready with asynchronous operation and choice of clock source
- › Frequency scaling without baud rate change
- › Energy saving: pretended networking and partial networking (ISO 11898-6 transceiver support) support (also in CAN FD mode)
- › Safety support: countable total amount of bus errors
- › Message objects can be freely assigned among the nodes
- › Configurable FIFO length, automatic gateway mode support
- › Acceptance mask filtering for each message object



Peripheral highlights

AURIX™ Ethernet module

Key highlight features

Ethernet MAC filter

- › MAC/VLAN/protocol filter for fast frame processing

QoS

- › 8 queues/DMA for frame separation
- › 4 transmit/4 receive
- › IEEE 802.1AS (for IEEE 1588-2008)
- › Shapers for bandwidth control
 - 802.1 credit-based shaper
 - Time-aware shaper

Interfaces

- › MII/RMII for 100 MBaud
- › RGMII for 1 GBaud

Freedom from interference

- › DMA operation → separated by hardware
- › No impact of queue operation on other queues, DMAs etc.
- › Independent control of each queue
- › Status/control in RAM → fast direct stack access

“Remote DMA” – fast data copy – RAM to RAM

- › Data transfer by DMA with no CPU required for transfer
- › Transfers triggered by hardware or by software
- › Transfers are hardware protected (in AURIX™)
- › Full-duplex transfers, low latency mode
- › All Ethernet standards and conformance tests are valid

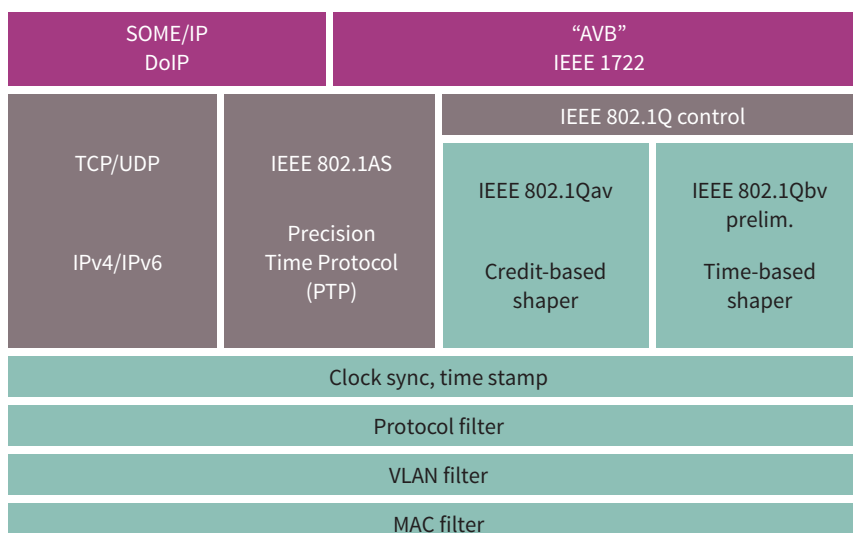
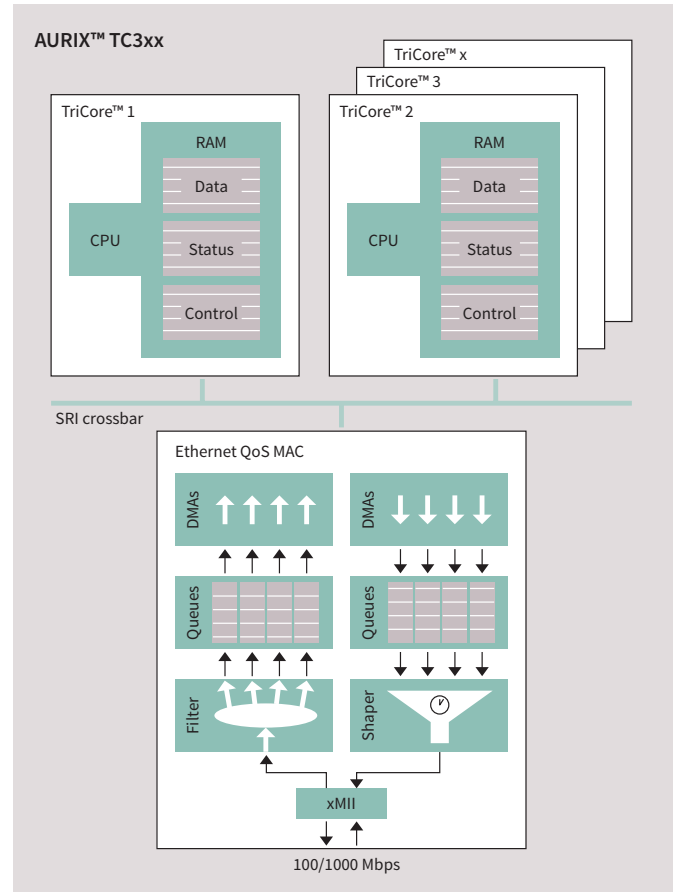

- Software implementation, “Stacks”
- Hardware implementation, available in AURIX™ TC3xx



AURIX™ TC3xx stand-by controller

Low power consumption, higher energy efficiency, easy implementation



Features and benefits

- > Feature available across whole AURIX™ TC3xx family
- > Integrated 8-bit MCU (ISO 26262 QM module)
- > Stand-alone operation
 - Separate power supply at core and IOs
 - Separate clock
 - Separate GPIOs
- > Standard tooling support enabling fast design-in
- > Real-time clock for periodic wake-up
- > Flexible choice of peripherals: LIN/SPI
- > Shared I/O with performance domain
- > Extremely low current consumption ~ μA range

Application recommendation

- > **Enhanced availability:** continue a limited set of functions while the main CPUs are rebooting after a reset (typ. watchdog reset)
- > **Steering and braking comfort:** temporary torque supply during main MCU
- > **Stand-by operation:** extremely low-power operation while the vehicle is parked
- > **(H)EV battery management:** monitor the battery's state-of-health and charge over a long parking period, e.g. vacation
- > **Keyless-go:** trigger main MCU for key communication
- > **Fuel leakage supervision:** on-board diagnostics and monitoring of tank pressure, e.g. while parked

eMMC/SDIO interface on

2 standard protocols supported

- > SDIO 2.0
 - 6 pins: 4 data, CLK, CMD
 - 3.3 V, 50 MHz max. clock
- > eMMC
 - 10 pins: 8 data, CLK, CMD
 - 3.3 V, 20 MHz

Use cases

- > External serial NAND-flash
- > Wi-Fi modems
- > Camera modules

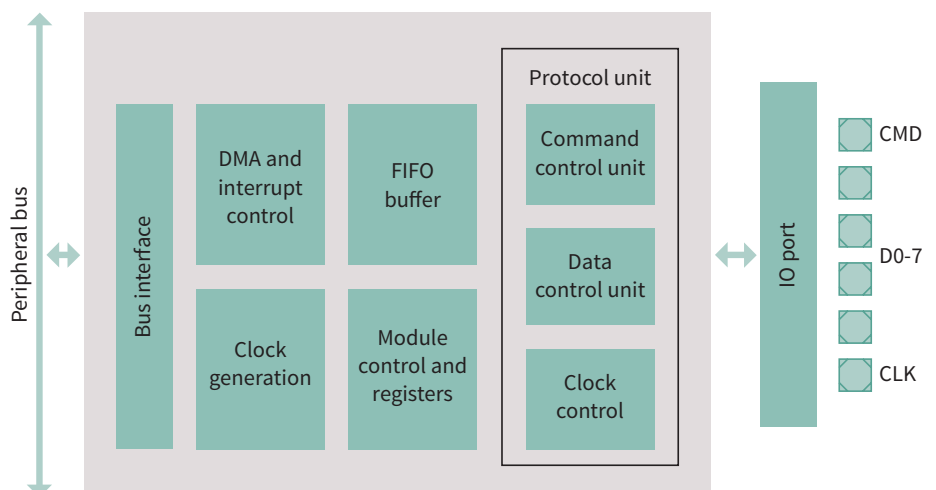

AURIX™ security features

AURIX™ security hardware

Infineon's AURIX™ 32-bit microcontroller family, with its embedded Hardware Security Module (HSM), is a perfect fit for automotive applications where secure on-board communication is required. Infineon not only offers a scalable portfolio of compatible AURIX™ devices with integrated HSM, but also the necessary software packages and support services. Furthermore, a best-in-class solution for automotive security can be achieved by combining AURIX™ microcontrollers with an Infineon embedded SIM (eSIM) and Infineon tamper-proof secure elements (TPM).

AURIX™ Hardware Security Module (HSM)

HSM provides a secure computing platform, consisting of a 32-bit CPU, special access-protected memory for storing the cryptographic keys and unique subscriber identifiers and dedicated hardware accelerators for the various automotive security use cases. A firewall separates HSM from the rest of the AURIX™ microcontroller.

The AURIX™ hardware security module offers a highly flexible and programmable solution based on:

- › Crypto and algorithm agility via software to support customer-specific solutions powered by a 32-bits CPU
- › AIS31-compliant True Random Number Generator (TRNG) with high random entropy over lifetime
- › State-of-the-art AES-128 hardware accelerator matching performance for automotive protocols
- › State-of-the-art PKC ECC 256 hardware accelerator for asymmetric encryption (only 2nd generation AURIX™ HSM)
- › State-of-the-art HASH SHA2-256 hardware accelerator for hashing (only 2nd generation AURIX™ HSM)
- › Secured key storage provided by a separated HSM-SFLASH portion. Alternative secure key storage feasible in dedicated HSM-PFLASH sections.



Download our new whitepaper and learn how to increase security in automotive ECU using Infineon's microcontroller AURIX™ <https://www.infineon.com/car-security-whitepaper>

Customer benefits

- › **Secured platform** – HSM provides a secured platform, separated from the rest of the microcontroller by a firewall, thereby creating a trusted execution environment.
- › **Security standard compliance** – AURIX™ HSM fulfills SHE HIS and EVITA Medium standards, while the 2nd generation AURIX™ HSM supports up to Full EVITA. In addition to fulfilling the aforementioned standards, HSM generations provide additional functionalities.
- › **Backward compatibility** – AURIX™ security solutions are backward compatible with the security SHE HIS implementations in previous TriCore™ based microcontroller families. Furthermore, the 2nd generation AURIX™ HSM is backward compatible with the 1st generation HSM.
- › **Security differentiation** – customized secure OEM or tier1 crypto apps can be processed within a trusted HSM execution environment, therefore allowing an independent HSM-specific software code review with reference to the huge application host software from multiple parties. This helps to harden the security level by reliably avoiding potential security backdoors.
- › **Convergence of security and safety** – AURIX™ microcontrollers address both functional safety as well as IT-security requirements, making sure they are properly integrated and don't conflict with one another.
- › **Secured failure analysis** – AURIX™ HSM offers a 256-bit password for debugger access protection to prevent unauthorized access to the debugging resources.

Typical use cases

- › Secured boot
- › Secured on-board communication
- › Software Over the Air (SOTA) updates
- › IP and tuning protection
- › Diagnostics via OBD/protected FAR flow/debug protection
- › Immobilizer

AURIX™ security hardware

AURIX™ hardware security module – anchor of trust thanks to separated logical protection domain

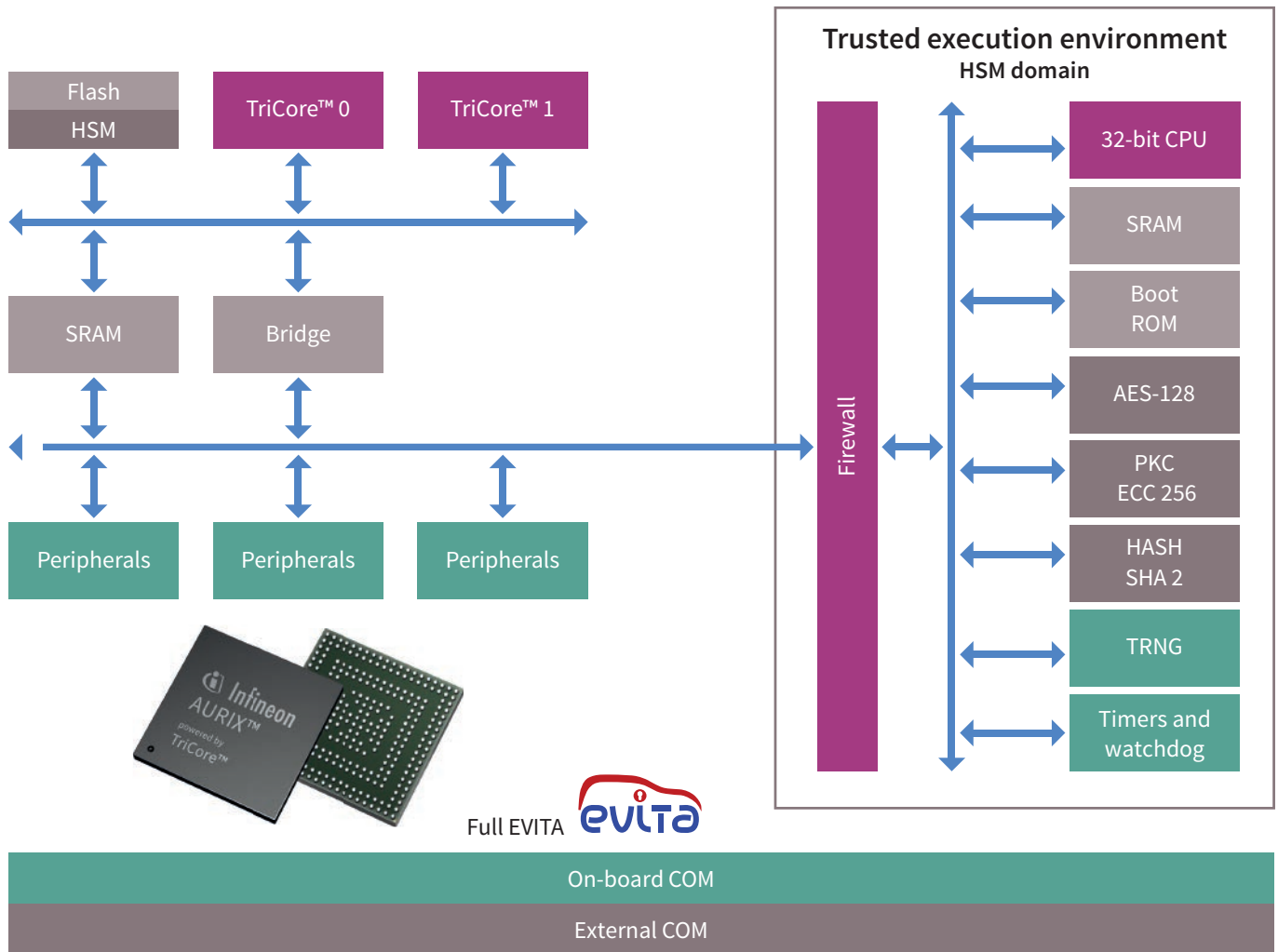

HSM domain creates a trusted execution environment

- > 32-bit ARM® MCU separated by security firewall
- > Background integrity checks of host application

Root of trust functions

- > Integrity monitoring
 - Secure boot, on-the-fly checks
- > Secure key storage
 - Protected data and program flash
- > Strong key generation
 - AIS31-compliant True Random Number Generator (TRNG)
- > Crypto accelerators
 - Symmetric: hardware AES-128
 - Asymmetric: hardware ECC-256, SHA-2





AURIX™ security features

Infineon's AURIX™ 32-bit microcontroller family offers a wide portfolio of compatible devices with an embedded Hardware Security Module (HSM), which offers cost-efficient solutions for all typical automotive security applications. The SHE+ driver controls the hardware security peripheral in the HSM domain

and interacts with the TriCore™ host core. SHE+ comes with the AUTOSAR CRY interface for integrating the HSM security features into an automotive application, including interface to AUTOSAR, communication from TriCore™ to HSM and vice versa, key storage functionality and security peripheral drivers.



	SHE HIS	HSM SHE+ TC2xx	TC3xx crypto driver via partners
Key management	10 keys	20 keys	Configurable
Symmetric data encryption/decryption	hardware-based AES-128-bit (ECB, CBC)	•	•
MAC generation/verification	Optional	•	•
Safe MAC verification	-	•	•
Random number management	SHE PRNG	•	•
Secure boot	Optional	•	•
Debug access	-	Enhanced by HSM debug options	Enhanced by HSM debug options
Other SHE services	•	•	•
Asymmetric encryption/decryption	-	-	software-based RSA1024 software-based ECC256

Typical applications	Tuning protection 	Immobilizer  Secure-on-board communication 	Possible extensions, depending on specific tier 1/OEM use case
Key management	•	•	•
Symmetric data encryption/decryption	•	•	•
MAC generation/verification	•	•	•
Safe MAC verification		(optional)	(optional)
Random number management	•	•	•
Secure boot	(optional)	(optional)	(optional)
Debug access	(for development)	(for development)	(for development)
Other SHE services	•	•	•
Asymmetric encryption/decryption	•	•	•

Embedded software

Infinion software product overview

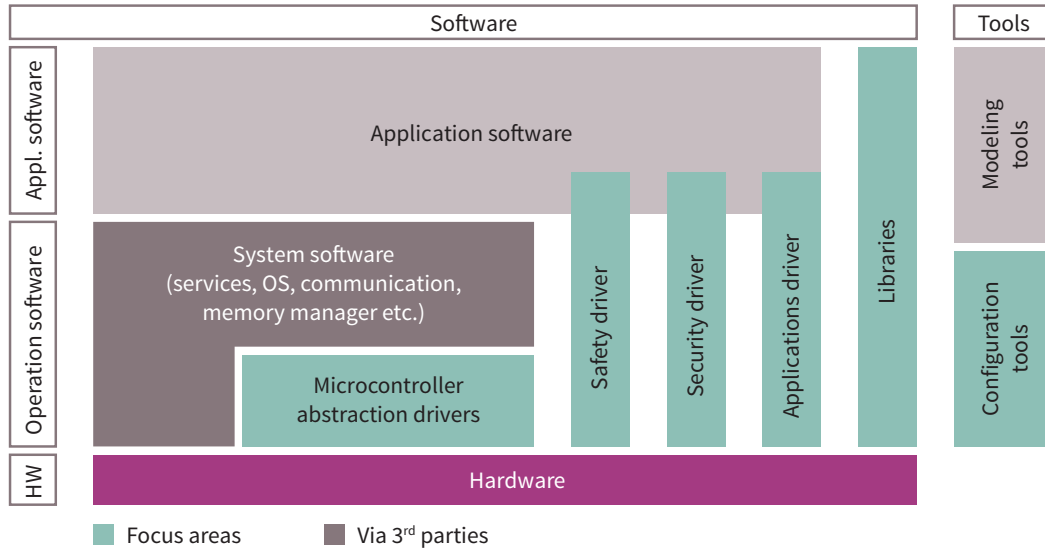

- > Microcontroller abstract drivers
 - AUTOSAR MCAL (includes Multicore support)
 - > Safety drivers
 - PRO-SIL™ SafeTcore (AUDO MAX)
 - PRO-SIL™ SafeTlib (AURIX™ TC2xx)
 - PRO-SIL™ SBST Software-Based Self-Test (AURIX™ TC3xx)
 - Safety libraries for AURIX™ TC3xx via software partners
 - > Security software
 - SHE+ driver (AURIX™ TC2xx)
 - AUTOSAR crypto driver (AURIX™ TC3xx) via software partners
 - Intrusion Detection Prevention Systems (IDPS) via software partners
 - > System software
 - AUTOSAR BSW via software partners
 - RTOS, communication stacks, etc. for industrial applications via software partners
 - > Libraries
 - DSP library
 - iLLD low-level peripheral drives
 - Libraries via software partners (e.g. LAPACK math library)
 - > Free TriCore™ tools
 - Free TriCore™ entry tool chain
 - Altium free tools for TriCore™/AURIX™
 - Free TASKING VX-toolset for AURIX™
 - Free TASKING Pin Mapper for AURIX™
 - Infineon tools
 - MemTool
 - DAS tool interface
 - AURIX™ Development Studio
- Note: List of all SW and tool partner can be find on page 86.

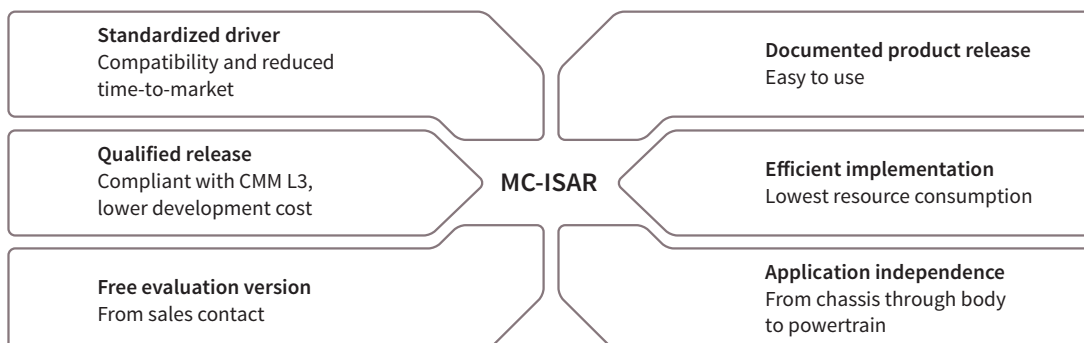

Embedded software

Infinion AUTOSAR MCAL drivers



MC-ISAR TC2xx/TC3xx product overview

Device		AURIX™ TC2xx	AURIX™ TC3xx	Safety claim at product release
AUTOSAR version		4.0.3	4.2.2/4.4.0	TC3xx
MCAL drivers	MC-ISAR Basic package	<ul style="list-style-type: none"> > MCU > WDG > GPT > SPI > Port > DIO > ICU > PWM > ADC > CAN > CanTrcv > LIN > FLS > FEE > BFX > CRC 	<ul style="list-style-type: none"> > MCU > WDG > GPT > SPI > Port > DIO > ICU (supporting GTM → new CCU6 and GPT12) > PWM (supporting GTM → new CCU6) > ADC > CAN > CanTrcv > LIN > FLS > FEE > OCU (not for all devices) > BFX > CRC 	<ul style="list-style-type: none"> > ASIL-B functionality claim – Except for CAN, CabTrcv, LIN > ASIL-D process to ensure freedom from interference in memory space
	MC-ISA COM enhanced package	<ul style="list-style-type: none"> > FlexRay (not for TC22x, 1x) > Ethernet (for ASRv4 only, not for TC23x, 2x, 1x) 	<ul style="list-style-type: none"> > FlexRay > Ethernet 	<ul style="list-style-type: none"> > ASIL-D process to ensure freedom from interference in memory space
	MCISAR MCD MCAL complex drivers	<ul style="list-style-type: none"> > UART, MSC (not for TC23x, 2x, 1x), DMA, FLSloader 	<ul style="list-style-type: none"> > CD: new production release DS-ADC, SMU > CD: DMA, FLSloader, UART, SMU, DS-ADC (not for all devices) 	<ul style="list-style-type: none"> > ASIL-B functionality claim – Except for CAN, CabTrcv, LIN > ASIL-D process to ensure freedom from interference in memory space
		<ul style="list-style-type: none"> > Demo code only for: HSSL (not for TC23x, 2x, 1x), SENT, I²C (not for TC23x, 2x, 1x), STM, DS-AC (not for TC23x, 2x, 1x), SMU, IOM 	<ul style="list-style-type: none"> > DEMOCD (demo code/App note – not released for production): HSSL, SENT, I²C, IOM, STM, IRQ 	<ul style="list-style-type: none"> > No safety claim
Configuration tool		Tresos	Tresos	
Compiler		<ul style="list-style-type: none"> > TASKING > Windriver Diab > HighTec GNU 	<ul style="list-style-type: none"> > Migrate to TASKING > HighTec GNU > Windriver > Greenhills for AUTOSAR 4.2.2 on request 	
Delivery package		Source code, documentation	Source code, documentation	

Development support

Emulation device

- › Emulation Devices (ED) are a very powerful solution for calibration, measurement, rapid prototyping and debugging
- › Emulation logic and RAM are added next to the unchanged Production Device (PD) part on the same chip
- › Cost-optimized PD, feature-rich ED
- › Same package for ED and PD, and a minimum or no additional external circuitry, allow a highly cost-optimized ECU design
- › Proven solution with broad tool support from leading automotive and debug tool vendors

AURIX™ highlights

- › Up to 4 MByte RAM for calibration with the same access speed as on-chip flash
- › Automotive measurement bandwidth (XCP) 15/30 MByte/s via regular 2/3-pin DAP interface

Trace and measurement

Contemporary vehicles are designed to meet rising market demands for engine performance, engine responsiveness, torque, drivability, fuel economy and emissions.

Infineon's proven Multicore Debug Solution (MCDS) enables manufacturers to design and optimize features to support these automotive trends. Unique MCDS features include the fully time-aligned parallel trace of many different on-chip sources, along with its highly powerful trigger capabilities.

Multicore Debug Solution (MCDS)

Key features

- › Tracing of CPUs, buses, performance events and peripheral internal states
- › Real time, cycle accurate and in parallel
- › Up to 1 MByte on-chip trace RAM (40 Gbit/s bandwidth)
- › Very powerful trigger capabilities
- › No additional pins needed besides the DAP interface
- › New Compact Function Trace (CFT) mode for continuous program trace via DAP
- › New fine-grained data trace qualification for automotive measurement

Multicore software development with AURIX™

The right partner for each development stage

Due to increasing performance demands in the automotive industry, multicore architectures are becoming ever more popular. The AURIX™ microcontroller family offers all the benefits of real-time hardware while supporting a multicore architecture capable of both asymmetrical and symmetrical multi-processing, and enabling the creation of ASIL-D systems for automotive applications.

Despite the fact that multicore architectures provide performance benefits, they also result in challenges with regard to software (SW) development. At Infineon, we fully understand the increasing performance demands across multiple applications, as well as the challenges that customers face when designing multicore software. To enable customers to achieve optimal performance when using the powerful AURIX™ architecture, Infineon has built up a network of strong partnerships with companies highly

specialized in multicore software development. Infineon's multicore partners can offer the best multicore expertise and tools on the market for each stage of the software design process, covering everything from the initial multicore knowledge acquisition phase right up to final optimization of the multicore software.

Infineon proactively addresses the challenges of multicore software development by offering special AURIX™ – dedicated literature and training for multicore software development. Furthermore, Infineon also participates in the organization of dedicated conferences, such as the EMCC (Embedded Multi-Core Conference) <http://www.multicore-conference.com> where various car manufacturers and suppliers share their experiences, challenges and latest findings from the field of multicore architecture.



Kits and evaluation boards

AURIX™ TC2xx – starter kits

AURIX™ TriBoards kits

- › Full evaluation board for development to write and debug your 1st programs
- › Includes getting started advice, free TriCore™ entry tool chain, technical documentation, compiler and debugger
- › TriBoard available for every silicon



AURIX™ TFT kits

- › Low cost board for early evaluation with limited access to signals
- › Additional touchscreen display for convenient handling
- › TFT board available for every silicon
- › **Click on the following to find/purchase the kit:**
www.infineon.com/aurix-kits



Arduino ShieldBuddy kit

- › The Hitex TC275 ShieldBuddy follows the Arduino standard
- › Compatible with 100's of Arduino application shields
- › Evaluation licenses available
- › Ideal for getting started on a high-end real time embedded industrial or automotive application as well as students and hobbyists



AURIX™ lite kit

- › AURIX™ TC275 device in LQFP-176 package
- › FTDI based debugger with micro USB
- › Use of Arduino Uno/compatible platform
- › Coming soon



Kits and evaluation boards

AURIX™ TC2xx – application kits

Motor control

KIT_AURIX_TC234_MOTORCTR

- › TC234 application kit with TFT display incl. safety supply TLF35584
- › Driving of a 3-phase PMSM/BLCD (12 V/max. 50 W)
- › **Click on the following to find/purchase the kit:**
www.infineon.com/cms/en/product/evaluation-boards/kit_aurix_tc234_motorctr/
- › BLDC motor from Nanotec integrated
- › Software available with flexible configuration



24 GHz radar

KIT_ATV_24GHZ_RADAR

- › Range-Doppler radar system with two Rx antennas and one Tx antenna based on AURIX™ TC264DA and BGT24ATR12
- › **Click on the following to find/purchase the kit:**
www.infineon.com/cms/en/product/evaluation-boards/kit_atv_24ghz_radar/
- › Allows implementation and testing of 24 GHz radar applications as Doppler movement detectors, FSK or FMCW range/position measurement



Wireless charging

KIT_AURIX_TC21_SC

- › Supports all fast charge smartphones
- › Unique power drive architecture minimizes EMI
- › Improved accuracy Foreign Object Detection (FOD)
- › **Click on the following to find/purchase the kit:**
www.infineon.com/cms/en/product/evaluation-boards/kit_aurix_tc21_sc/



Kits and evaluation boards

AURIX™ TC3xx – starter kits

AURIX™ 2G standard TriBoard

- › Full evaluation board for development to write and debug your 1st programs
- › Includes getting started advice, free TriCore™ entry tool Chain, technical documentation, compiler and debugger.
- › TriBoard available for all productive silicon (TC38x, TC39x)
- › Standard TriBoard availability

AURIX™ 2G TFT application kit

- › Low cost board for early evaluation with limited access to signals
- › Additional touchscreen display for convenient handling
- › Available for standard and ADAS pinout's for selected devices
- › TriBoard available for **all productive silicon** (TC38x, TC39x)
- › Basic application kit TFT availability

Arduino ShieldBuddy kit

- › The Hitex TC375 ShieldBuddy follows the Arduino standard
- › Compatible with 100's of Arduino application shields
- › Evaluation licenses available
- › **Launched at embedded world**



NEW

AURIX™ lite kit

- › AURIX™ TC375 device in LQFP-176 package
- › FTDI based debugger with micro USB
- › Coming soon

NEW

Kits and evaluation boards

AURIX™ TC3xx – application kits

New hybrid kit for inverter applications

NEW

- > **IFX system offering:** such as power modules, gate drivers, current and position sensors to develop inverter systems
- > **Software** to start development of inverter for 3-phase motors
- > **AURIX™ 2G hardware** optimized logic board for testing different hybrid kits for inverter applications

Gateway 24 V board for CAV, bus, truck

NEW

- > Includes AURIX™ TC397 x2 with & automotive Ethernet switch Realtek RTL9047AA switch available for standard and ADAS pinout's
- > **Click on the following to find/purchase the kit:**
www.infineon.com/24Vgatewayboard
- > Rich connectivity: connect up to: 1000Base-T1, 100Base-T1 x5, CAN-FD x12, LIN x4, and FlexRay devices x4



Automotive secure gateway 12 V

NEW

- > Includes AURIX™ TC377TX with & automotive Ethernet switch Marvell 88Q5050
- > **Click on the following to find/purchase the kit:**
www.infineon.com/12Vgatewayboard
- > Rich connectivity: connect up to: 1000Base-T1 x2, 100Base-T1 x5, CAN-FD x12, LIN x2, and FlexRay devices x2



Motor control board TC3xx

NEW

- > Based on TC397
- > Software FOC (Field Oriented Control) algorithm: encoder as position sensor (GPT12)
- > 3-phase current sensing (EVADC), PWM generation (GTM), communication with drive board (QSPI) commands via TFT display (QSPI)



Ease of use

Solution finder

Infiniteon solution finder is an easy to use online tool for finding, comparing and buying semiconductor products in an application context visualized by block diagrams and combined with electrical and thermal simulations powered by Infineon Designer, PLECS and PowerEsim. Currently it covers motor control and drives from different industries with focus on power semiconductor and controller, Switched

Mode Power Supplies (SMPS), LED lighting and DC-DC Point of Load (PoL) converters. You can choose the suitable AURIX™ TC2xx or XMC™ device according to the application, industry and parameters that you are looking for, in the different filters and solutions that this tool is providing.

Solution finder – check solutions (PLECS)

The screenshot shows the 'Solutions' tab of the Infineon Solution Finder. It features a navigation bar with steps: 'Select application', 'Integration level', 'List of suggested solutions', 'Compare', 'Trade-off ratings', and 'Actions'. The main content area is divided into 'Solutions' and 'Products' sections.

Solutions Section:

Integration Level	Category & Product	Chip Count	Footprint (mm) ²	Design Target	Price Indication	Actions
Discrete	Controller: 1 x SAK-TC277TP-64F200N DC Gate driver: 3 x 2ED02006-FI	13	2009.44	Flexible to design	\$	[Download] [PDF] [Buy]

Products Section:

AURIX™ Family – TC27xT

Product	Datasheet	Simulation	OPN	Product Status	Package name	Peripherals (macro)	Instruction Set Architecture
<input checked="" type="checkbox"/> SAK-TC277TP-64F200N DC	Download	no	TC277TP64F200NDC0XUMA1	active and preferred	PG-LFBGA-292	AD Converter DSP Unit (e.g. MAC) On-chip Clock Generation On-chip Voltage Regulator Real Time Clock (RTC) Floating Point Unit Watchdog Timer Oscillator Watchdog	TriCore™ v1.6P (32-bit) TriCore™ v1.6E (32-bit)
<input type="checkbox"/> SAL-TC277TP-64F200N DC	Download	no	TC277TP64F200NDGLXUMA1	active and preferred	PG-LFBGA-292	AD Converter	TriCore™ v1.6P (32-bit) TriCore™ v1.6E (32-bit)
<input type="checkbox"/> SAL-TC275TP-64F200N DC	Download	no	TC275TP64F200NDGLXUMA1	active and preferred	PG-LQFP-176	AD Converter	TriCore™ v1.6P (32-bit) TriCore™ v1.6E (32-bit)
<input type="checkbox"/> SAK-TC275TP-64F200N DC	Download	no	TC275TP64F200NDC0XUMA1	active and preferred	PG-LQFP-176	AD Converter	TriCore™ v1.6P (32-bit) TriCore™ v1.6E (32-bit)
<input type="checkbox"/> SAL-TC270TP-64F200N DC	Download	no	TC270TP64F200NDGLX2SA1	on request	S-BDWB-T0	AD Converter	TriCore™ v1.6P (32-bit) TriCore™ v1.6E (32-bit)

The screenshot shows the 'Selected solutions' tab of the Infineon Solution Finder. It features a navigation bar with steps: 'Select application', 'Select Load', 'Set Parameters', 'Compare Solutions', 'Check', and 'Actions to report, partner and buy'. The main content area is divided into 'Solution' and 'Architecture' sections.

Solution Section:

Integration Level	Category & Product	Chip Count	Footprint (mm) ²	Design Target	Price Indication	Actions
Discrete	Controller: 1 x SAK-TC277TP-64F200N DC Gate driver: 3 x 2ED02006-FI Discrete Switch: 6 x IK250N6SE55 Sensor: 3 x TLV4968-1TA	13	2009.44	Flexible to design	\$	[Download] [PDF] [Buy]

Architecture Section:

Rollover the block diagram for detailed product information and links.

Solution architecture: A block diagram showing the system architecture. It includes an Interface (VD), a Motor (M), and a Sensor. The system is integrated in one housing.

Evaluation board (detailed BOM): A photograph of the evaluation board and its packaging.

Ease of use

AURIX™ forum

Following the strategy of going wider to the mass market for AURIX™ TC2xx and AURIX™ TC3xx. The AURIX™ Forum came as the first platform of support for our mass market and core account customers. We strongly improved the maintenance of the forum, as it supports the customers to find answers quickly by themselves.

We provided FAQs about the most critical topics, which has strongly increased the traffic in our AURIX™ forum.

Now our customers can find the support needed in our Forum.



- › A maintained forum helps customers to find answers quickly by themselves
- › Fundamental support to the mass market customers
- › Promoting materials, trainings, banners & products as support to the mass market customers

Ease of use

Artificial intelligence in AURIX™ TC3xx

Artificial Intelligence is not limited to high end applications anymore and has entered the embedded world within the last decade. We enter a new era of innovation possibilities for the automotive industry, where AI brings much more than the well-known automated driving, with solutions regarding connected cars or safety concerns, among others. AURIX™ performances enable optimizing AI algorithms to face the challenge growing amount of data vs. communication and processing technology.

Partnership



Teraky's Intelligent Signal Processing product running on AURIX™ TC3xx presented at OktoberTech2019. Simultaneously processes 50 signals and reduces the data by 95% at low latency and low percentage of CPU capacity.

Key benefits

- > Up to 6.9 MB SRAM
- > Up to 1.8 GMACs
- > Up to 6 CPUs @ 300 MHz
- > DSP capability up to 1.8 GFLOPS
- > Up to 4000 DMIPS (with 2400 DMIPS ASILD)
- > Low power consumption

Suggested products

- > TC39x

System diagram



Ease of use

AURIX™ Development Studio

The AURIX™ Development Studio is a free of charge Integrated Development Environment (IDE) for the TriCore™-based AURIX™ microcontroller family. It is a comprehensive development environment, including **Eclipse IDE, C-compiler and multicore debugger**, Infineon Low-Level Driver (**iLLD**), with no time and code-size limitations that enables editing, compiling, and debugging of application code.

The AURIX™ Development Studio is supported by **expert trainings**

Code examples, trainings and all the technical documentation you may need are readily available at your fingertips

- › Integrated Development Environment (IDE)
 - › AURIX™ TC2xx microcontroller expert-training: <https://www.infineon.com/aurix-expert-training>
 - › AURIX™ TC2xx microcontroller quick-trainings
 - › GitHub for the code examples: https://github.com/Infineon/AURIX_code_examples?intc=0560030
 - › AURIX™ forum for more questions and support: <https://www.infineonforums.com/>
- You can download the IDE through our webpage: <https://www.infineon.com/aurixdevelopmentstudio>

The AURIX™ Development Studio is composed of three parts, which are linked to each other in a connected system.



KIT_AURIX_TC297_TFT the AURIX™ TC275 ShieldBuddy in combination with AURIX™ Development Studio:

You can use AURIX™ Development Studio with the following kits

- › [KIT_AURIX_TC275_ARD_SB](#)
- › [KIT_AURIX_TC297_TFT](#)

AURIX™ and XMC™ PDH partners

Preferred Design Houses (PDH) and software resellers

Optimized open-market customer support set up for systems using AURIX™ and XMC™, including software and other Infineon products, such as power products, sensor products and modules.

The preferred design house extends the support force by specifying and customizing the know-how. Furthermore, it brings an additional value for customer service. The preferred design house supports the set up for systems using AURIX™ and XMC™, including software and other Infineon products. Our partners are trained to use AURIX™ and XMC™.

<p>Classic (Free of charge)</p>	<ul style="list-style-type: none"> › 1st level customer support covering Infineon products/solutions › Technical interface and support to the customer 	<ul style="list-style-type: none"> › Driving design at customer › Basic training for design teams at customer › 24 h response time to the customer
<p>Premium (Consultancy mode)</p> <p>To be agreed between customers and PDH</p>	<ul style="list-style-type: none"> › Project management and project-specific application support › Specification of general software defining required layers, control and data flow structure etc. › Specification and implementation of custom device drivers › Optimization of software components with regard to speed/code size 	<ul style="list-style-type: none"> › Software testing › Support for project-specific functional safety engineering › Project-specific support for security solution › Safety support › Security support › Multicore support

Infineon releases its new Preferred Design Houses (PDH) partner ecosystem where each PDH partner has its own webpage. The new partners' ecosystem enables our PDHs to better promote their services and facilitate the access to information to our customers.

You can discover our PDH webpage via our PDH table shown in the all MCU webpages (see table below) or you can go directly to www.infineon.com/preferredesignhouse

AURIX™ and XMC™ PDH partners

Click on the logo to get directed to Hitex PDH webpage for a detailed overview on the offered services.

Infinion Preferred Partner	GLOBAL			EMEA																AMERICAS				CHINA	KOREA					
	+	+	+	+	+	+	+	+	+	+	+	+	+	+	+	+	+	+	+	+	+	+	+	+	+	+	+	+		
Autosar	●	●	●	●	●	●	●	●	●	●	●	●	●	●	●	●	●	●	●	●	●	●	●	●	●	●	●	●	●	●
Motor Control	●	●	●	●	●	●	●	●	●	●	●	●	●	●	●	●	●	●	●	●	●	●	●	●	●	●	●	●	●	●
Lighting	●	●	●	●	●	●	●	●	●	●	●	●	●	●	●	●	●	●	●	●	●	●	●	●	●	●	●	●	●	●
PFC Power conversion	●	●	●	●	●	●	●	●	●	●	●	●	●	●	●	●	●	●	●	●	●	●	●	●	●	●	●	●	●	●
AURIX™ general support HW	●	●	●	●	●	●	●	●	●	●	●	●	●	●	●	●	●	●	●	●	●	●	●	●	●	●	●	●	●	●
AURIX™ general support SW	●	●	●	●	●	●	●	●	●	●	●	●	●	●	●	●	●	●	●	●	●	●	●	●	●	●	●	●	●	●
Safety Support IEC61508	●	●	●	●	●	●	●	●	●	●	●	●	●	●	●	●	●	●	●	●	●	●	●	●	●	●	●	●	●	●
Safety Support ISO26262	●	●	●	●	●	●	●	●	●	●	●	●	●	●	●	●	●	●	●	●	●	●	●	●	●	●	●	●	●	●
Security support /SHE+	●	●	●	●	●	●	●	●	●	●	●	●	●	●	●	●	●	●	●	●	●	●	●	●	●	●	●	●	●	●
XMC™ general support HW	●	●	●	●	●	●	●	●	●	●	●	●	●	●	●	●	●	●	●	●	●	●	●	●	●	●	●	●	●	●
XMC™ general support SW	●	●	●	●	●	●	●	●	●	●	●	●	●	●	●	●	●	●	●	●	●	●	●	●	●	●	●	●	●	●
Class B classification	●	●	●	●	●	●	●	●	●	●	●	●	●	●	●	●	●	●	●	●	●	●	●	●	●	●	●	●	●	●
Capacitive sensing with XMC	●	●	●	●	●	●	●	●	●	●	●	●	●	●	●	●	●	●	●	●	●	●	●	●	●	●	●	●	●	●
Secure boot for XMC™	●	●	●	●	●	●	●	●	●	●	●	●	●	●	●	●	●	●	●	●	●	●	●	●	●	●	●	●	●	●
24 GHz radar	●	●	●	●	●	●	●	●	●	●	●	●	●	●	●	●	●	●	●	●	●	●	●	●	●	●	●	●	●	●
77 GHz radar	●	●	●	●	●	●	●	●	●	●	●	●	●	●	●	●	●	●	●	●	●	●	●	●	●	●	●	●	●	●
Brochure	●	●	●	●	●	●	●	●	●	●	●	●	●	●	●	●	●	●	●	●	●	●	●	●	●	●	●	●	●	●
Email	●	●	●	●	●	●	●	●	●	●	●	●	●	●	●	●	●	●	●	●	●	●	●	●	●	●	●	●	●	●
Phone	●	●	●	●	●	●	●	●	●	●	●	●	●	●	●	●	●	●	●	●	●	●	●	●	●	●	●	●	●	●
in f	●	●	●	●	●	●	●	●	●	●	●	●	●	●	●	●	●	●	●	●	●	●	●	●	●	●	●	●	●	●

Basic ●

Essential principles and elementary know-how to support a customer; provision of basic training for design teams

Advanced ●

High-level project-specific application support/consulting

Expert ●

Extensive knowledge and ability to fully support development

TASKING Pin Mapper

The Pin Mapper can save a substantial amount of time for developers and provides assurance that no pin conflicts exist. In addition, the pin mapper generates a data file for PCB design, eliminating the chance for errors when passing data manually.

Benefits of the TASKING Pin Mapper for AURIX™

- > The Pin Mapper tool reduces developer time and costs, while improving the quality of results.
- > Configuration takes place via an intuitive eclipse based GUI with built-in knowledge about AURIX™ devices and packages. This saves the developer from the tedious task of consulting piles of device manuals and maintaining configuration settings in spreadsheets.
- > Configuration errors/conflicts are detected at entry time and can be either automatically resolved by the built-in conflicts solver or solved manually. Whereas traditionally such errors remain hidden until code has been generated and is tested.
- > The Pin Mapper reduces miscommunication between individuals and teams by creating all project files from one source. The Pin Mapper creates:
 - Device initialization code in ISO-C format
 - A spreadsheet (CVS) file for project documentation
 - A schematic symbol block that can be imported by PCB design tools such as Altium Designer

Supported TriCore™ devices

- > AURIX™ family (TC22x, TC23x, TC26x, TC27x, TC29x)
- > AURIX™ 2G family (TC38x, TC39x,...)

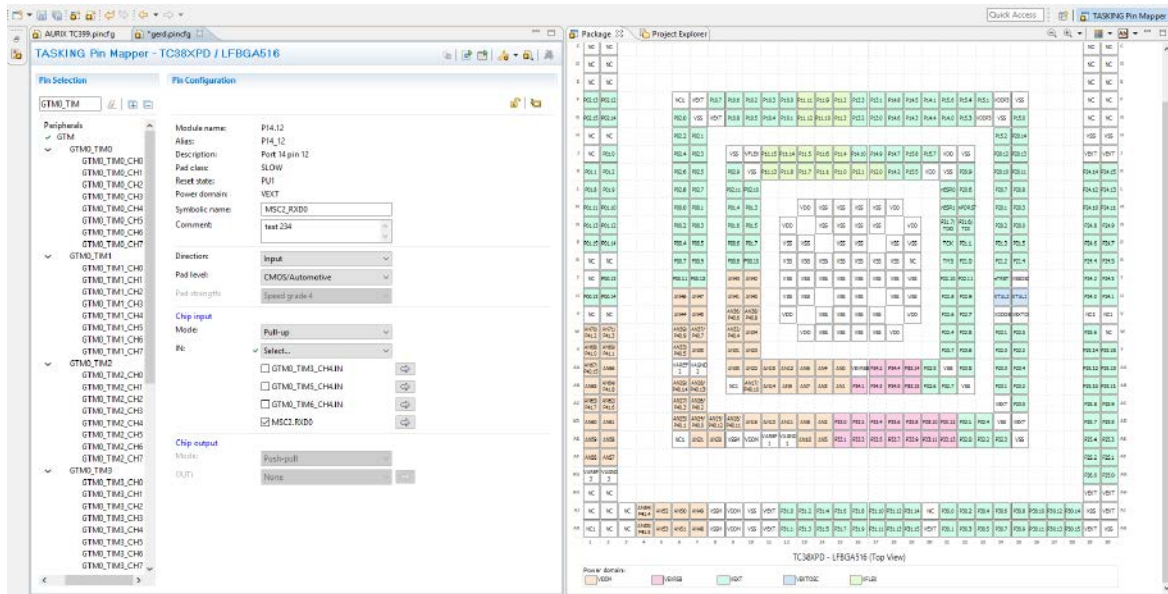

Free TriCore™ entry tool chain

This free-of-charge entry tool chain provides all the features required to develop and test software for TriCore™ and AURIX™. The tool can be used with all available TriCore™ and AURIX™ starter kits and application boards.

Key features

- > Eclipse-based IDE
- > Project wizard to easily define the project properties for device and board support
- > High-performance GNU C compiler
- > Integrated source-level debugger
- > On-chip flash programming support

For further information on TriCore™ tools, please visit www.infineon.com/aurix-tools



Applications

AURIX™ for powertrain and xEV applications

The new powertrain

Emission free mobility will be the driving force in the automotive industry for the next decades. The transition from burning natural resources to sustainable electrified mobility is inevitable. Certainly, this is a disruptive and challenging undertaking to the well-established automotive industry, but it also provides opportunities – we call it the era of “the new powertrain”.

Energy efficiency for conventional powertrain

Electronic automotive components are key to raising fuel efficiency levels and cutting emissions. The latest environment protection agency standards – Euro 6 and the upcoming Euro 7 for passenger cars and Euro 3 and Euro 4 for motorcycles – are driving developments in advanced engine management.

Now with up to six embedded TriCore™ cores and 300 MHz operation, the AURIX™ TC3xx family members have the real-time performance needed for improved combustion technologies such as Homogeneous Charge Compression Ignition (HCCI) as well as for direct injection, smart turbo-charger and valve actuation applications

AURIX™ is also ideal for a range of innovative transmission technologies such as Double Clutch Transmission (DCT) and modern Continuous Variable Transmission (CVT). The AURIX™ family offers high temperature operation of up to 150°C junction enabling operation in the harsh transmission environment. This is also of benefit in transfer case (4WD) applications, where AURIX™ is a leader in systems requiring the challenging combination of high temperature, safety and security.

A key benefit of AURIX™ in powertrain is its scalability between generations, which enables customers to follow a platform approach with tooling and software costs being shared across multiple applications. This approach can help customers to venture into the opportunities presented by the new xEV applications as part of “the new powertrain”.

The new powertrain: motion control and energy management

The new powertrain refers to the change of mind, from enhancing a combustion engine with electrification towards a pure electric driven vehicle. Motion control and energy management describes well what “the new powertrain” is about: motion control is self-explanatory, referring to the acceleration as well as deceleration of a vehicle. Energy management describes the management, conversion and distribution of energy using various sources.

While they excel in fuel economy, driving experience and reducing CO₂ emissions, Hybrid Electric Vehicles (HEV) and Electric Vehicles (EV) have the drawbacks of a higher cost, limited drive-range and safety concerns (e.g. risk of battery over-charging). Thanks to their high performance, functional integration and application-based software support, TriCore™ products are the ideal solution for (H)EV motor drives and are perfectly positioned to support lithium ion batteries which will likely be the energy storage system of choice in the near future.



No other MCU family can offer this **combination** of functionality across multiple compatible products for **powertrain and xEV**

Flexible inverter implementation for motion control

TriCore™ offers a CPU load of less than 3% at 300 MHz frequency for the complete Field-Oriented Control (FOC) algorithm. The TriCore™ AURIX™ family offers multicore architecture, allowing inverter control, hybrid torque management and DC-DC conversion to be executed within one single microcontroller. Nevertheless, the TriCore™ AURIX™ family has built-in resolver functionality, helping customers to save the cost of implementing an external resolver IC.

Energy management for battery and new technology to come

Often seen as the master micro in battery balancing topology, the TriCore™ AURIX™ family proposes a 32-bit stand-by domain combined with an integrated 8-bit standby controller, essential for battery balancing under low-power mode (e.g. vacation parking). As cross-border charging becomes popular, AURIX™ has increased its SRAM to flash ratio to enable various charging protocols. Infineon is the market leader in providing Hardware Security Module (HSM), a feature that prevents the main CPU from illegal manipulation, making the billing for battery charging more trustworthy.

Applications

Powertrain Domain Controller (PDC)

Application example



Application features

- > Human-machine interface
- > Torque coordination
- > Driving strategy control
- > Cruise control
- > Charging coordination
- > Thermal management & environment models
- > Predictive functions
- > Safety and fail-operational
- > Firewall and security

Suggested products

- > TC29x
- > TC39x
- > TC3E7
- > TC387

System benefits

- > Microcontroller with best-in-class real-time performance
- > Scalable platform – performance, memory size and I/Os
- > Support A/B swap for SOTA
- > Rich legacy peripherals (CAN FD, LIN, ...) for integrated gateway application
- > Enhanced communication (Ethernet) for fast connection to network & SoC
- > External memory interface for data logging
- > HSSL connectivity for direct coupling with SoC
- > Availability of AUTOSAR 4.x
- > Supports safety levels up to ASIL-D



Applications

Gasoline direct injection

Application example



Thanks to its state-of-the-art safety features, the TriCore™ AURIX™ family enables systems to achieve the highest safety level up to ASIL-D. The scalable AURIX™ family includes the GTM, the de-facto industry standard timing module that supports highly complex engine management, while meeting the market’s most stringent emissions regulations.

Application features

- > Direct injection
- > Scalable software-based knock detection
- > Variable valve control
- > Throttle and EGR control
- > Turbocharging
- > Catalyst after-treatment
- > Start/stop system

System benefits

- > Microcontroller with best-in-class real-time performance
- > Scalable platform – performance, memory size and I/Os
- > Committed to reduce CO₂ by 20%
- > Anti-theft protection and tuning protection
- > Increased knock detection accuracy via DS-ADC
- > Enhanced communication (Ethernet)
- > Dedicated peripherals for powertrain
- > Supports safety levels up to ASIL-D

Suggested products

- > TC27x
- > TC39x
- > TC3Ex



Applications

Diesel direct injection

Application example



Thanks to its state-of-the-art safety features, the TriCore™ AURIX™ family enables systems to achieve the highest safety level up to ASIL-D. The scalable AURIX™ family includes the GTM, the de-facto industry standard timing module that supports highly complex engine management, while meeting the market’s most stringent emissions regulations.

Application features

- › Direct injection (piezo/magnetic)
- › In-cylinder pressure measurement
- › Hardware-supported security enhancements
- › Throttle and EGR control
- › Turbocharging
- › Diesel particulate filter
- › ‘Blue’ after-treatment support (e.g. urea-based SCR)

Suggested products

- › TC27x › TC3Ex
- › TC29x › TC38x
- › TC39x

System benefits

- › Microcontroller with best-in-class real-time performance
- › Scalable platform – performance, memory size and I/Os
- › Committed to reducing NOx and particulate matter in line with the Euro 6 standard
- › Hardware-supported IP/anti-theft protection and tuning protection
- › Increased accuracy with in-cylinder pressure sensing via DS-ADC
- › Enhanced communication (Ethernet)
- › Dedicated peripherals for powertrain
- › Supports safety levels up to ASIL-D



Applications

Double-clutch transmission – electrical control

Application example

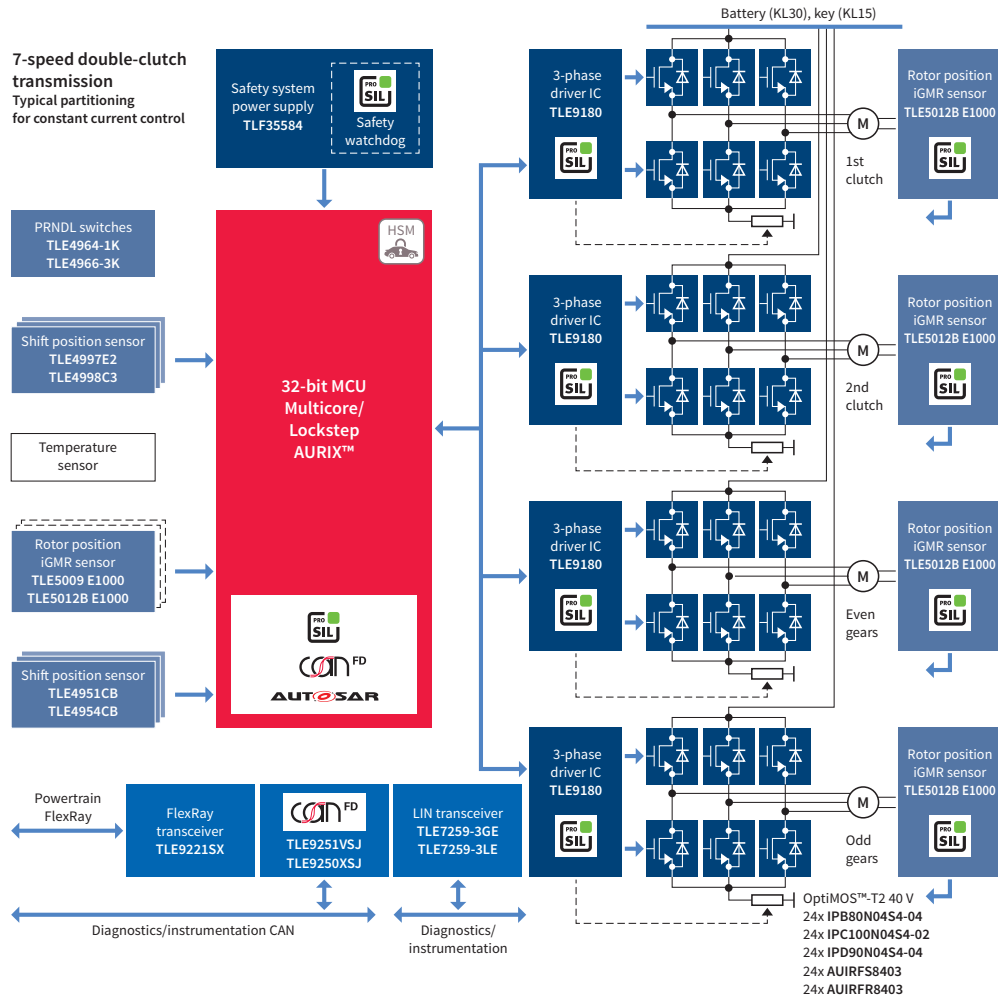

Thanks to its state-of-the-art safety features, the new TriCore™ AURIX™ family enables systems to achieve the highest safety level up to ASIL-D. The rich scalability of the AURIX™ family permits a platform approach that meets the needs of a range of transmission systems. Furthermore, the hot temperature package and bare die solutions enable AURIX™ to be used in both attached and integrated control units.

Application features

- > Ultra-fast gear switching
- > Closely coupled with engine control via high-speed CAN/CAN FD/FlexRay link
- > Supports four 3-phase DC-brushless E-drives (dry-DCT)
- > High microcontroller junction bare die temperature

Suggested products

- > TC270
- > TC275
- > TC37x
- > TC38x

System benefits

- > Improved fast clutch control
- > Feature set optimized for wet and dry DCT designs
- > Continuous torque on wheels ensures a dynamic driving experience
- > Hot bare die capabilities enable microcontrollers to be placed directly where they are needed in the system
- > Infineon e-motor driver
- > Supports safety levels up to ASIL-D

Applications

Transfer case

Application example

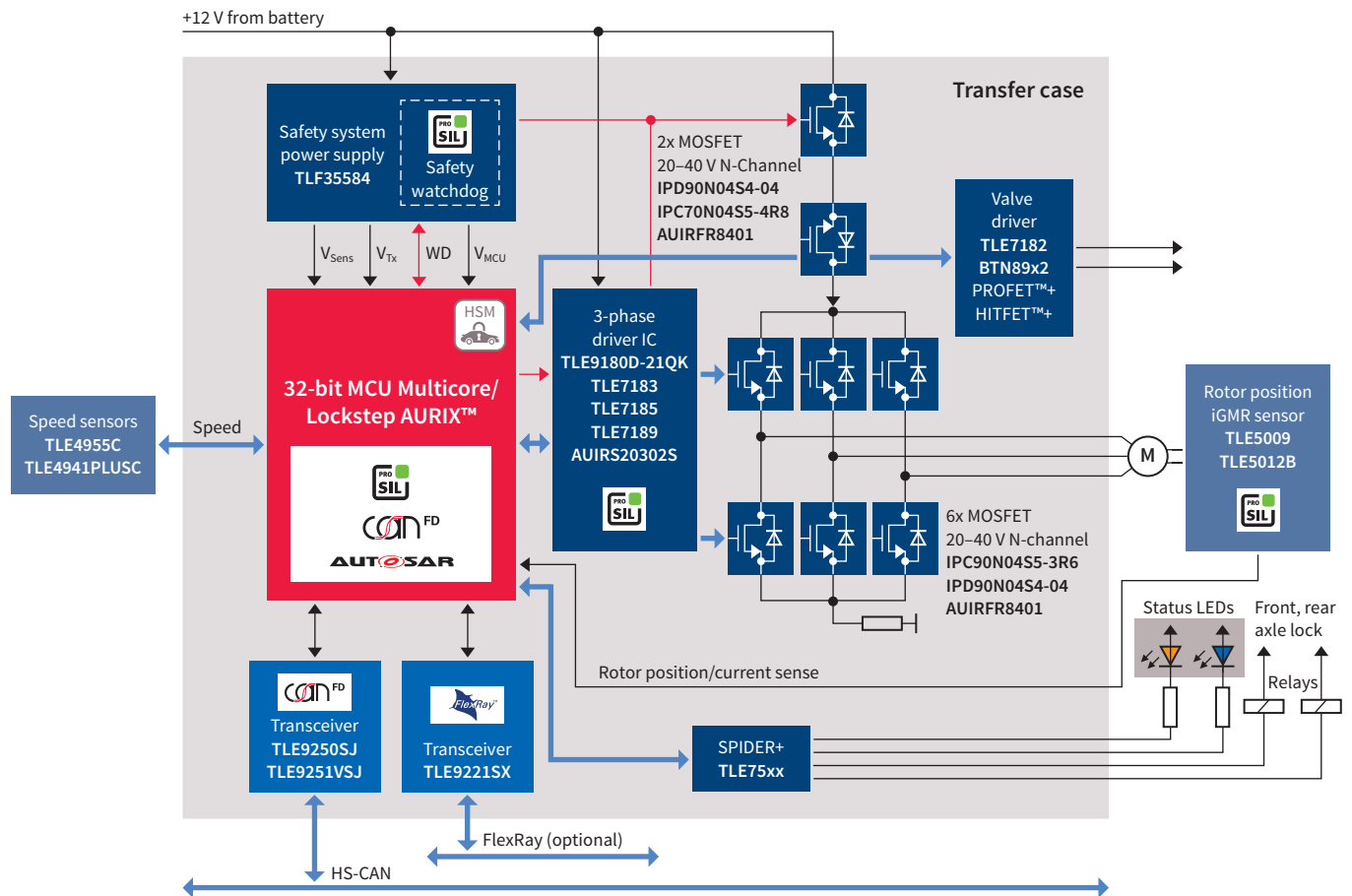

In Four-Wheel Drive (4WD) and All-Wheel Drive (AWD) vehicles, the transfer case is the part of the drivetrain responsible for the transfer of torque from the transmission to the front and rear wheels. The market now demands increased performance to drive BLDC motors and ever-greater functional safety requirements. AURIX™ has the state-of-the-art safety features required to enable systems to achieve ASIL-D, the highest safety level.

Application features

- › More accurate torque distribution, enabling new features such as higher comfort and flexible settings
- › Fuel economy improvements due to advanced slip control
- › Safety requirements up to ASIL-D
- › Extended ambient temperature range to meet stringent environment requirements
- › Secure CAN communication

Suggested products

- › TC23x
- › TC33x

System benefits

- › Advanced timer unit for totally flexible PWM generation and hardware input capture
- › Redundant flexible 12-bit ADC
- › Scalability over flash, RAM and peripherals, offering the best cost-performance ratio
- › High microcontroller junction bare die temperature
- › Supports the safety level ASIL-D
- › Safety software: Infineon SafeTcore library
- › Availability of AUTOSAR 4.x
- › HSM security module to prevent tampering



Applications

AURIX™ for xEV applications

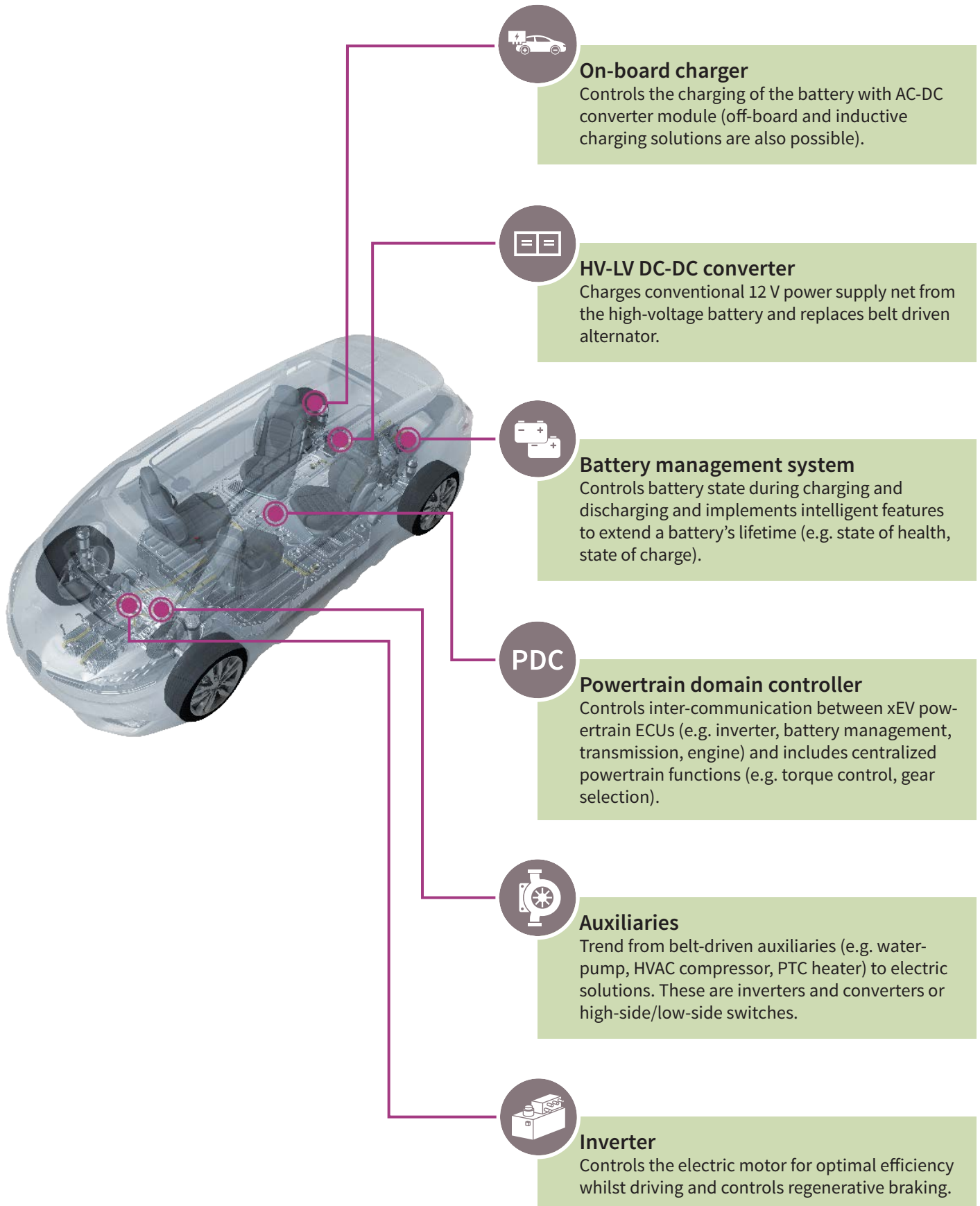

Applications

xEV main inverter

Application example



The inverter controls the electric motor in an electric or hybrid drivetrain. Its function is equivalent to an Engine Management System (EMS) in vehicles with an internal combustion engine. Therefore, the inverter is a key component for achieving optimal vehicle dynamics in an electric or hybrid vehicle. In addition to driving the electric motor, it converts the regenerated braking energy and feeds it into the battery. Consequently, a vehicle's range is significantly impacted by the efficiency of the control strategy of an inverter. In addition to efficiency, functional safety and security are key requirements for an inverter system in order to control a vehicle's dynamics.

Application features

- > Three cores for task split (base SW, FuSa, app SW)
- > Lockstep architecture
- > 50% performance increase compared to AURIX™ TC2xx
- > Optimized PWM pattern generation in GTM

System benefits

- > Resolver IC replacement with DS-ADC (cost saving)
- > Facilitates integration with other xEV applications
- > Supports safety levels up to ASIL-D

Suggested products

- > TC27x
- > TC29x
- > TC37x
- > TC38x



Applications

DC-DC converter (low voltage to 12 V)

Application example

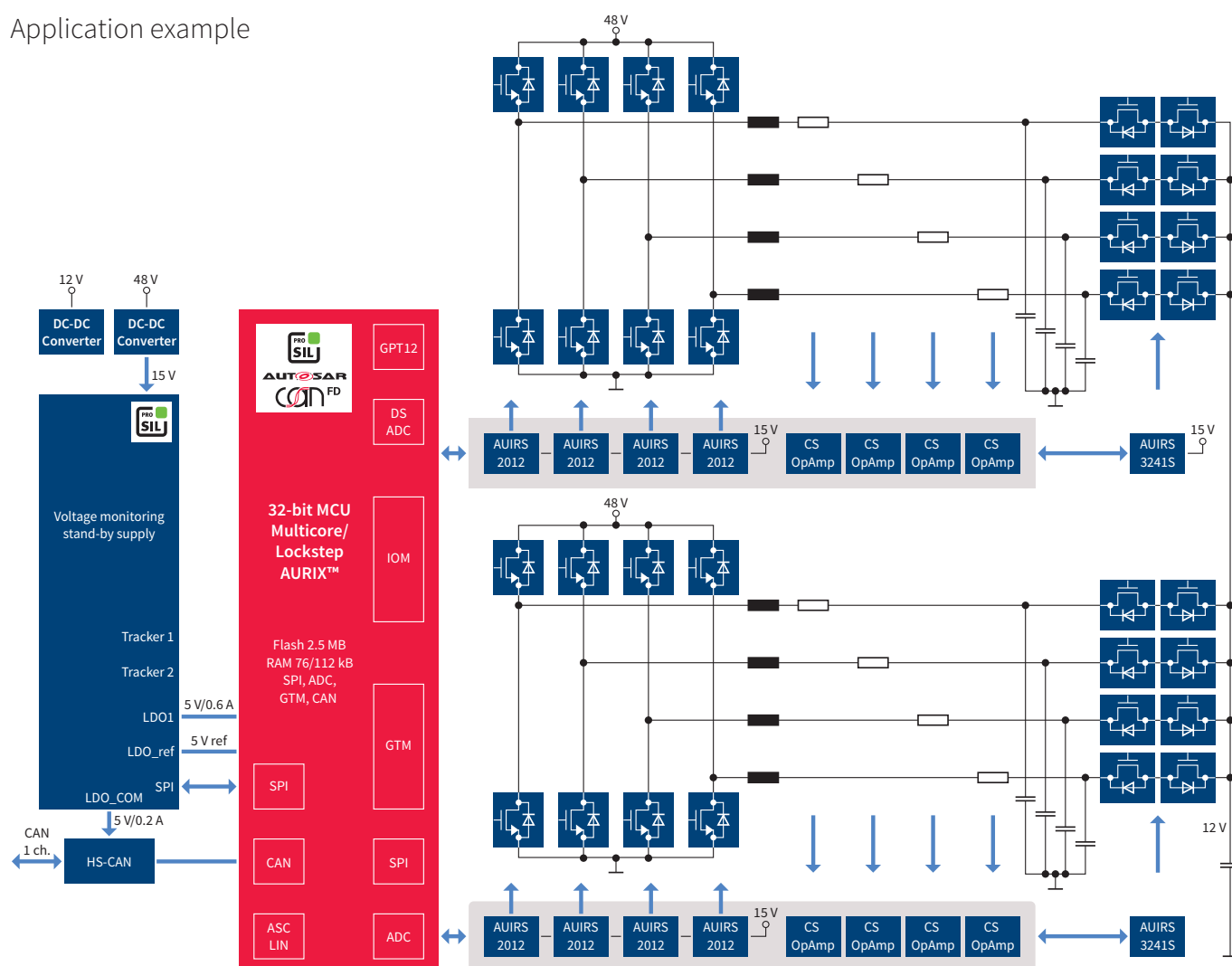

The DC-DC converter ECU is responsible for the conversion of voltage between the low voltage domain (typically 48 V to 60 V) and the 12 V domain in mild hybrid cars. The 48 V domain powers stop-start motors, hybrid motors, and turbochargers, enabling engine downsizing and better fuel economy and performance.

Application features

- > Supports current control-specific features
- > Fast compare ADCs with support for up to 5 Msps
- > Supports flexible PWM generation via a scalable timer across the family
- > Supports DC-DC converter for 48 V systems and for high-voltage systems
- > CAN FD support
- > Ethernet support

System benefits

- > Scalability across the family supporting seamless migration in different DC-DC power and efficiency classes
- > Enables sub-system integration (communication handling + DC-DC control) thanks to the AURIX™ multicore performance
- > Supports bi-directional DC-DC converter functionality
- > Supports safety levels up to ASIL-D

Suggested products

- > TC26x
- > TC36x
- > TC27x
- > TC37x

Applications

xEV battery management system

Application example



The battery management system controls the battery state during charging and discharging. Intelligent functionality is needed to extend the battery lifetime, which has a considerable impact on the total cost of ownership. The State of Health (SoH), State of Charge (SoC) and Depth of Discharge (DoD) of the battery is permanently monitored.

Application features

- > Multicore and lockstep core architecture
- > Fast communication interface
- > Integrated low-power 8-bit stand-by controller
- > Hardware Security Module (HSM)

Suggested products

- > TC23x
- > TC26x
- > TC27x
- > TC33x
- > TC36x
- > TC37x

System benefits

- > Standard UART communication (available MCAL driver) supporting robust and cost optimized (capacitive coupling)
- > Optional fault wake-up function from cell monitoring IC (TLE9012AQU) via TLE9015QU to TLF35584
- > Synchronized accurate voltage measurement throughout all cells in the battery
- > Battery security enabled through Hardware Security Module (HSM)



Applications

EV charging station

Application example

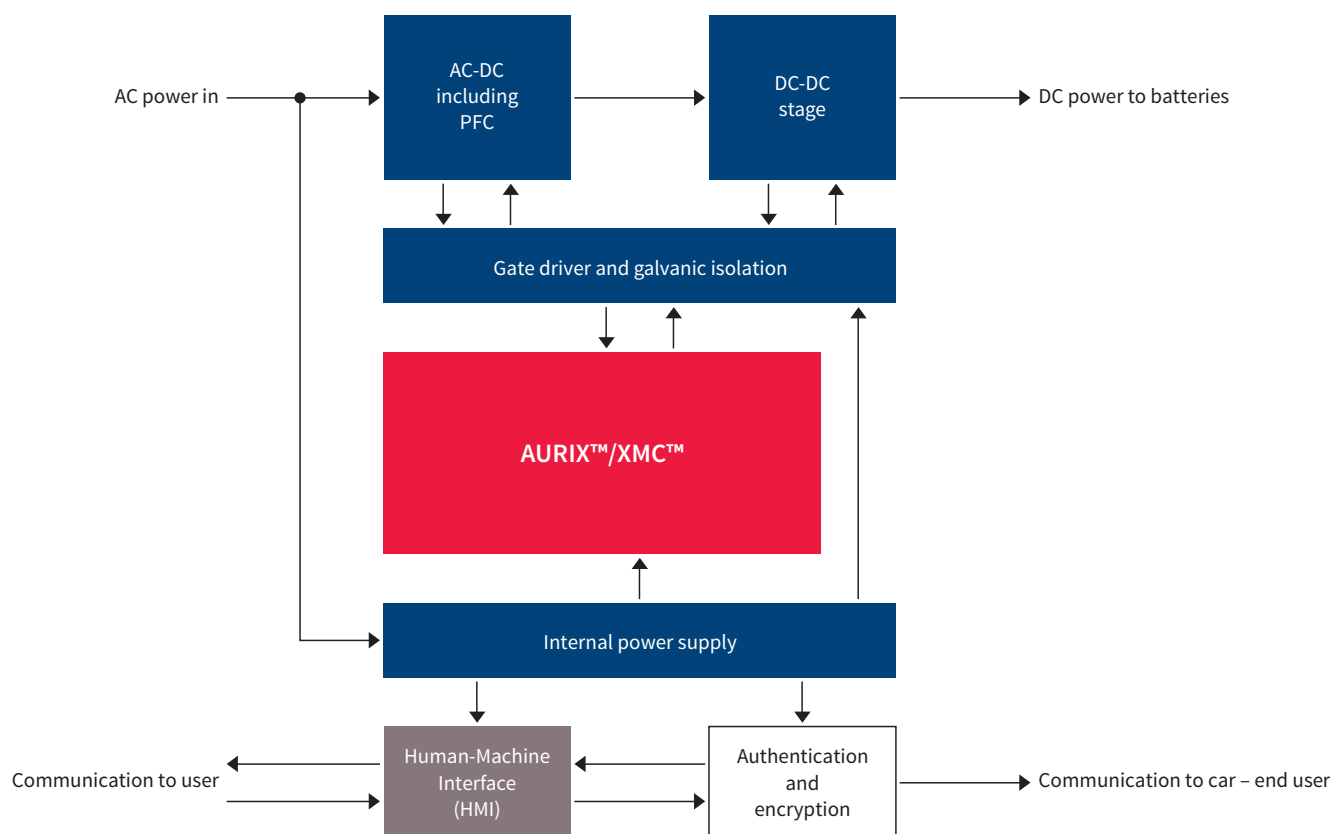

Off-board charging, where users can charge plug-in hybrids and pure EVs in private garages and open parking lots, demands an optimized solution with high MCU switching frequency to stay efficient and cost competitive. The Infineon XMC™ family is the answer! If you have security or safety requirements, you can scale from XMC™ family to AURIX™ to support your solution.

Application features

- › Platform concept to allow extensive customization
- › RAM: 8 kB up to 352 kB
- › Flash: 16 kB up to 2 MB
- › Accurate analog-mixed signal peripherals
- › Fast timer/PMW peripherals
- › Rich communication interfaces
- › 16–196 pin-count packages
- › Long-term availability

System benefits

- › Scalable family with compatibility: software, pin-out
- › Performance, efficiency and cost competitiveness
- › Great scalability and software re-use across the whole family
- › Rich ecosystem and tooling environment for a shorter time-to-market

Suggested products

- › XMC4xxx – 32-bit ARM® Cortex®-M4 MCU



Applications

AURIX™ for safety applications

AURIX™ made for safety

The AURIX™ architecture is designed in accordance with an ISO 26262-compliant process to efficiently meet ASIL-D requirements.

The platform uses up to four cores in a diverse lockstep architecture combined with cutting-edge safety technology, such as safe internal communication buses or a distributed memory protection system. Innovative encapsulation techniques allow the integration of software with various safety levels (QM to ASIL-D) from different sources, thereby significantly reducing system complexity. Thanks to this optimized approach, multiple applications and operating systems (such as steering, braking, airbag and advanced driver assistance systems) are seamlessly hosted on a unified platform. This leads to productivity gains of up to 30%, resulting in a smaller development outlay and reduced time-to-market for our customers.

Furthermore, Infineon extends the microcontroller safety roadmap with devices dedicated to the Advanced Driver Assistance System (ADAS) segment, such as radar or camera applications. Innovation has been focused on system partitioning in order to further integrate system functionality and consequently reduce the complexity and area, providing our customers with highly optimized

solutions. The new devices include high-speed interfaces, integrated hardware acceleration and enhanced ECU validation and instrumentation tools. All ADAS devices support ISO 26262 safety methodology, meaning that they can be involved in automatic decisions to assist drivers, such as emergency braking.

AURIX™ made for scalability

Thanks to its market-leading expertise, Infineon has translated customer demands for individual scalability into a universal product roadmap. Designed to optimize its customers' investment, the AURIX™ family comes with a comprehensive range of fully modular components, thereby ensuring long-term design flexibility. The devices range from an ultra high-end, 300 MHz six-core device with 16 MB of embedded flash, down to 160 MHz and 1 MB flash.

The package portfolio includes a BGA-516 package with a ball-compatible BGA-292 package (I/O subset), and compatible QFP-176, QFP-144, QFP-100 to BGA-196 and QFP-80 packages.

Applications

Chassis domain control

Application example

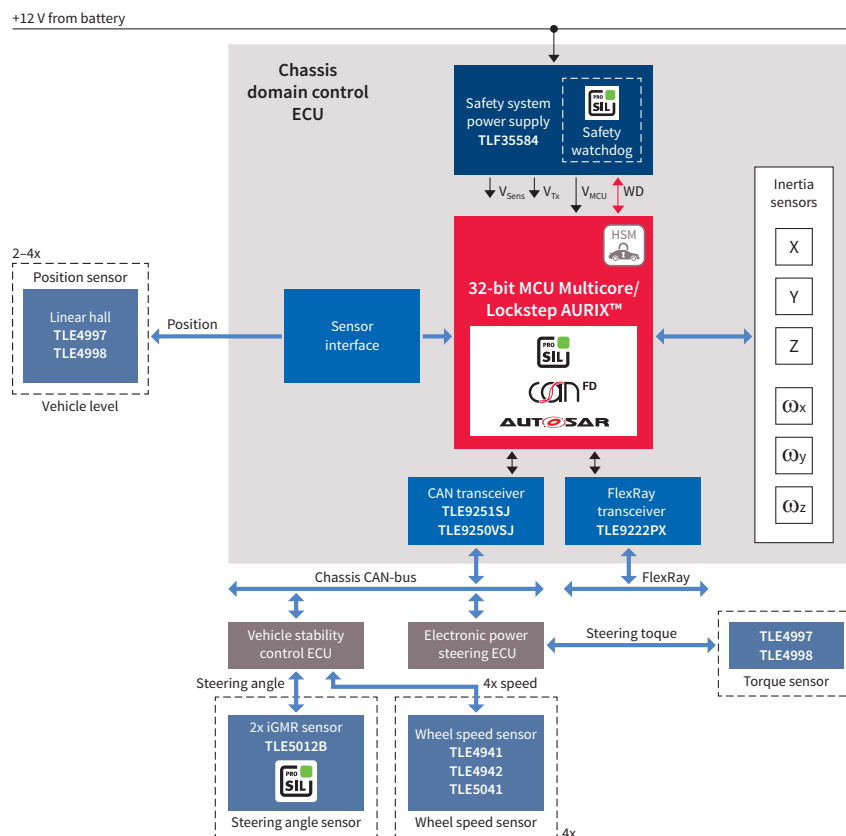

Thanks to its state-of-the-art safety features, the new TriCore™ AURIX™ family enables systems to achieve the highest ASIL-D safety level, which is already required in contemporary domain control systems. The latest diverse lockstep technology with clock delay (diverse lockstep core) significantly reduces the software overhead and enables fast time-to-market. Thanks to a scalable multicore system and innovative encapsulation techniques, this supports the integration of software with mixed-criticality levels from different sources, thereby allowing multiple applications and operating systems to be seamlessly hosted on a unified platform.

Application features

- > TriCore™ DSP functionality
- > Best-in-class performance with up to six-core 300 MHz
- > Supports the floating point and fix point with all cores
- > Up to 6.9 MB of internal RAM
- > Communication peripherals: CAN, LIN, FlexRay, Ethernet
- > Innovative single supply of 5 V or 3.3 V
- > External memory interface
- > ISO 26262 conformance to support safety requirements up to ASIL-D
- > Availability of AUTOSAR 4.x

System benefits

- > Advanced communication with FlexRay and Ethernet
- > Highest available performance with integrated FPU
- > Flexible DMA unit
- > Scalability over flash, RAM and peripherals
- > Proven safety concept to support ISO 26262
- > Innovative supply concept leads to best-in-class power consumption

Suggested products

- > TC37x
- > TC38x
- > TC39x
- > TC3E7



Applications

Scalable EPS solution

Application examples



Thanks to its state-of-the-art safety features, the new TriCore™ AURIX™ family enables systems to achieve the highest ASIL-D safety level, which is already required in contemporary steering systems.

The latest diverse lockstep technology with clock delay (diverse lockstep core) significantly reduces the software overhead and enables fast time-to-market.

Its rich scalability meets a variety of different electric power steering system demands.

Application features

- > Flash 512 KB – 8 MB
- > Scalable flash from 1 – 16 MB
- > Performance 160 MHz – 6x 300 MHz
- > Advanced timer unit for totally flexible PWM generation and hardware input capture
- > Redundant flexible 12-bit ADC
- > Hardware SENT interface for a low CPU load
- > Hardware built-in self-test
- > ISO 26262 conformance to support safety requirements up to ASIL-D
- > Availability of AUTOSAR 4.x

System benefits

- > Scalability over flash, RAM and peripherals offering the best cost-performance ratio
- > Serves all kinds of EPS systems, such as column or belt drive
- > Proven safety concept to support ISO 26262
- > Innovative supply concept leads to best-in-class power consumption

Suggested products

- > TC22x
- > TC23x
- > TC32x
- > TC33x
- > TC36x



Application example

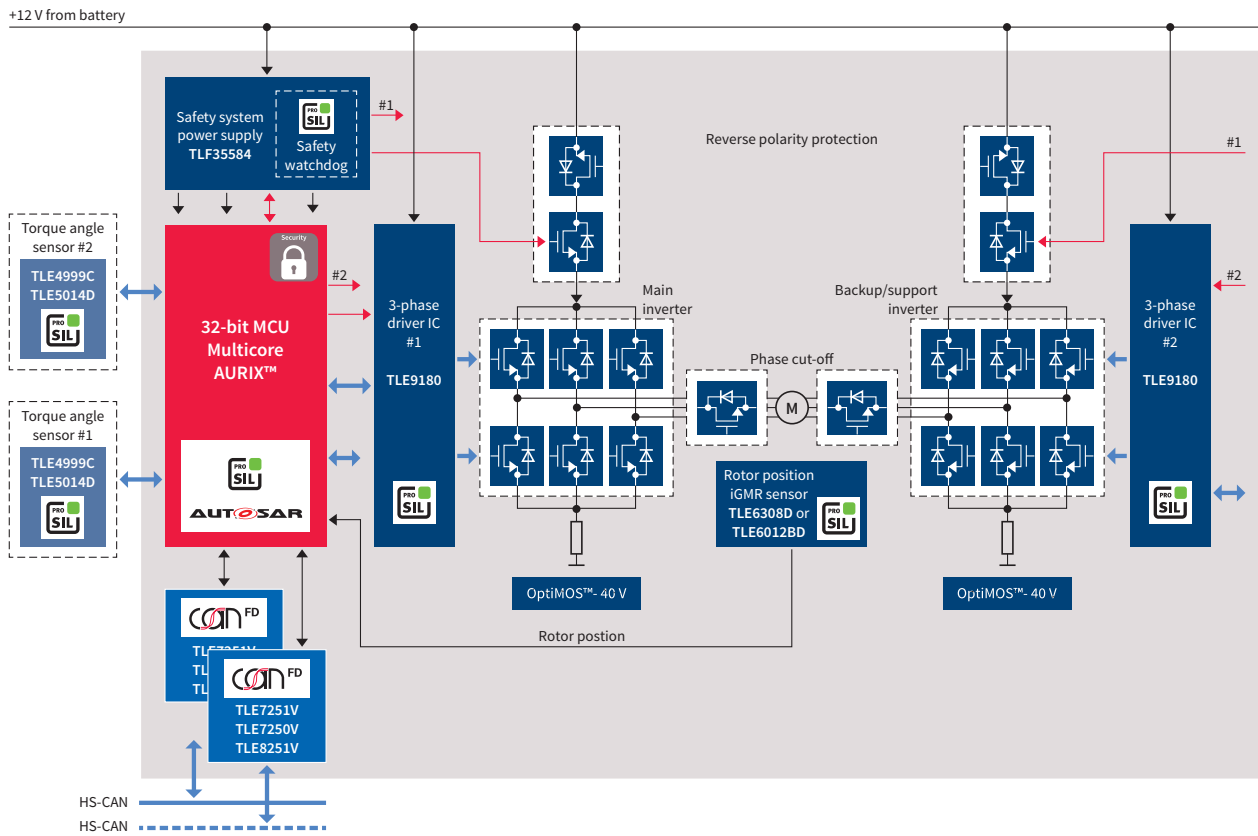

Infineon EPS system solution for high-availability autonomous drive systems L0-L3

- › 1x MCU + 2x inverters for high-available EPS

System benefits

- › Multicore MCU with dual power stage and dual torque sensor
 - Dual cores to separately control dual motors or 6 phase motors
 - Separately resettable cores to keep 1 motor running while one CPU resets
 - Ability to recover most frequent errors identified, no software reset required
- › Dual inverter PWM and multi ADCs
- › Secured high-speed communication with domain controller: CAN FD, FlexRay, SPI and Ethernet



Applications

Scalable EPS solution

Application examples

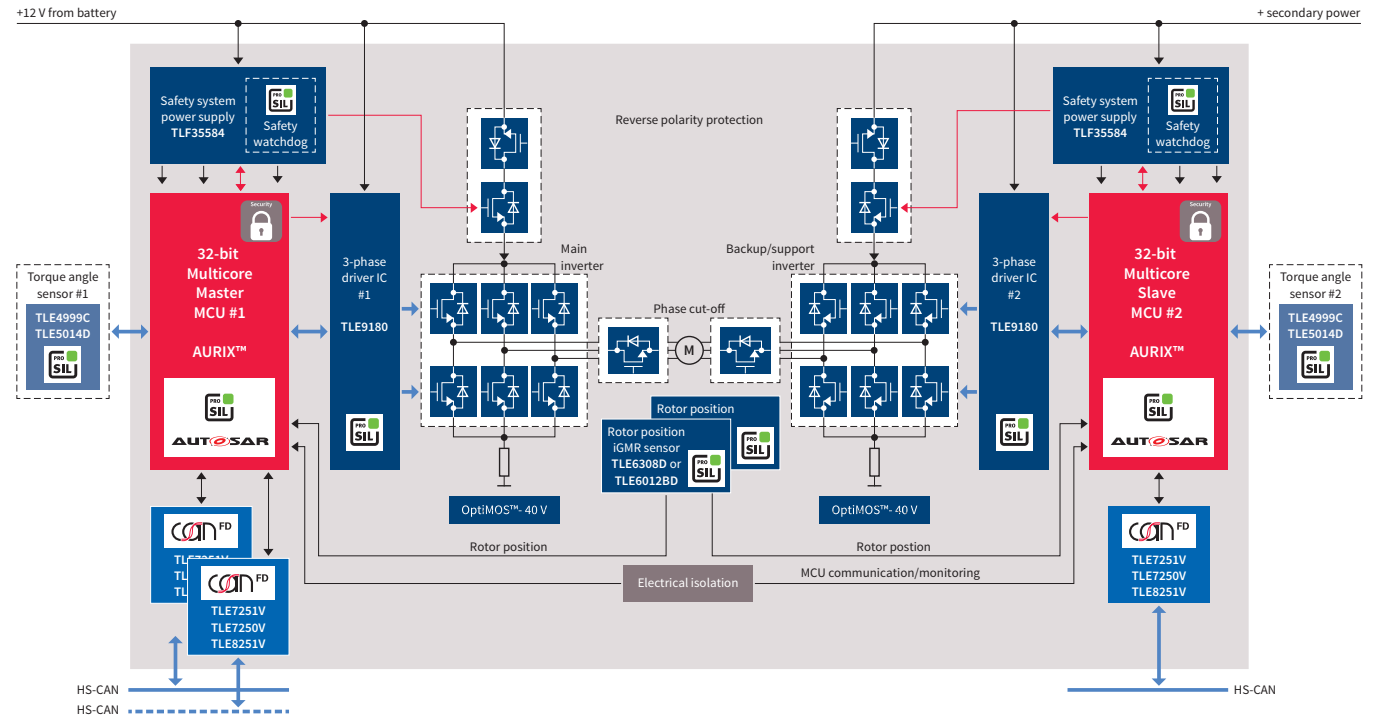

Infiniteon EPS system solution for fail-operational autonomous drive systems L3-L5

- › 2x MCUs are used, each MCU has 1x inverter for fail-operational or high-available EPS

System benefits

- › Highly scalable ASIL-D performance architecture to support the master/slave concept
- › Advanced timers for PWM generation and ADC synchronization
- › Small package options: BGA-196 (12 x 12) or TQFP-80 (14 x 14) for full redundancy



Applications

Brake Vehicle Stability Control (VSC)

Application example

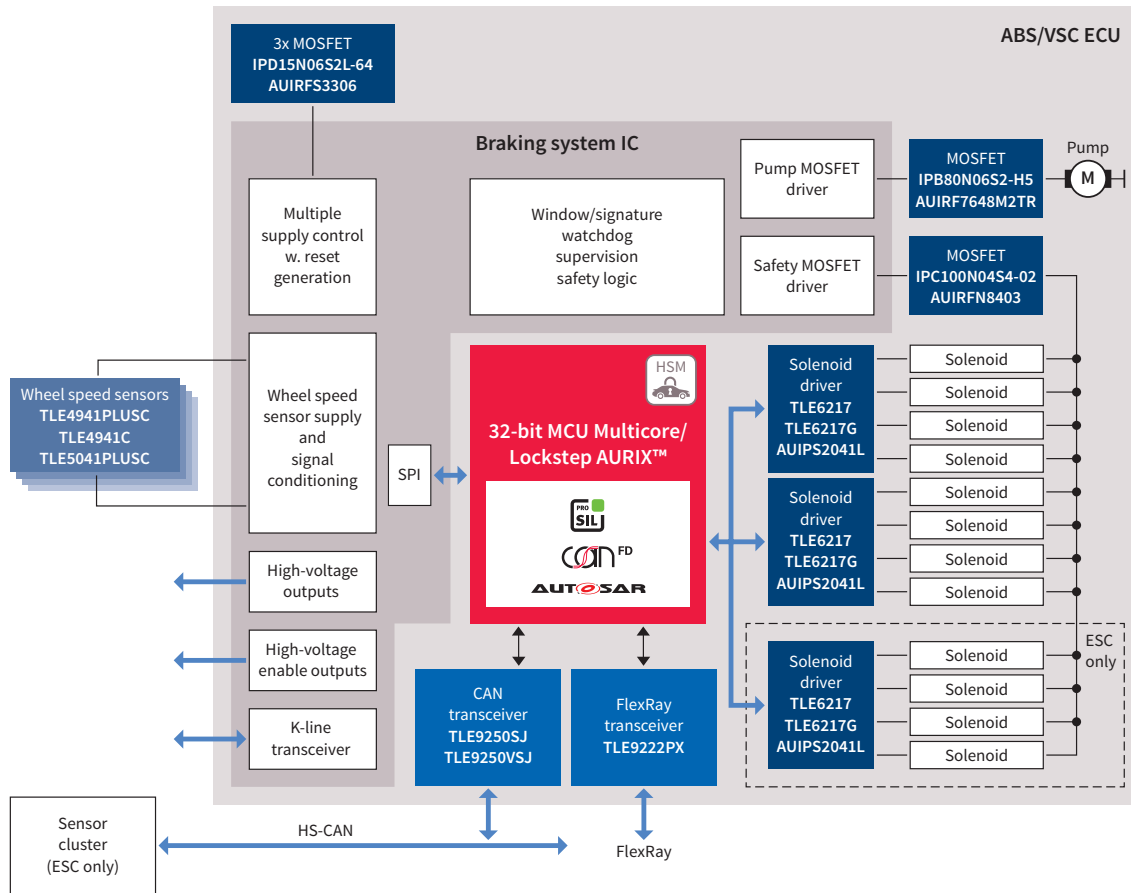

Thanks to its state-of-the-art safety features, the new TriCore™ AURIX™ family enables systems to achieve the highest ASIL-D safety level, which is already required in contemporary braking systems. The latest diverse lockstep technology with clock delay (diverse lockstep core) significantly reduces the software overhead and enables fast time-to-market. The scalability supports an optimized cost-performance fit for basic ABS systems up to highly integrated ESC systems.

Application features

- > Scalable flash 1 – 16 MB
- > Performance 160 MHz – 6x 300 MHz
- > Dedicated peripheral set: LIN, CAN, SPI, FlexRay, Ethernet
- > Advanced timer unit for totally flexible PWM generation and hardware input capture
- > Redundant flexible 12-bit ADC
- > Hardware SENT interface for a low CPU load
- > Hardware built-in self-test overhead
- > Safety software: Infineon SafeTcore library
- > ISO 26262 conformance to support safety requirements up to ASIL-D
- > Availability of AUTOSAR 4.x

System benefits

- > Scalability over flash, RAM, performance and peripherals leads to an optimized cost-performance fit
- > Proven safety concept to support ISO 26262 validated by 3rd party
- > Innovative supply concept leads to best-in-class power consumption and saves external component costs

Suggested products

- > TC36x
- > TC37x
- > TC38x
- > TC39x
- > TC3E7



Applications

Multi-purpose camera

Application example

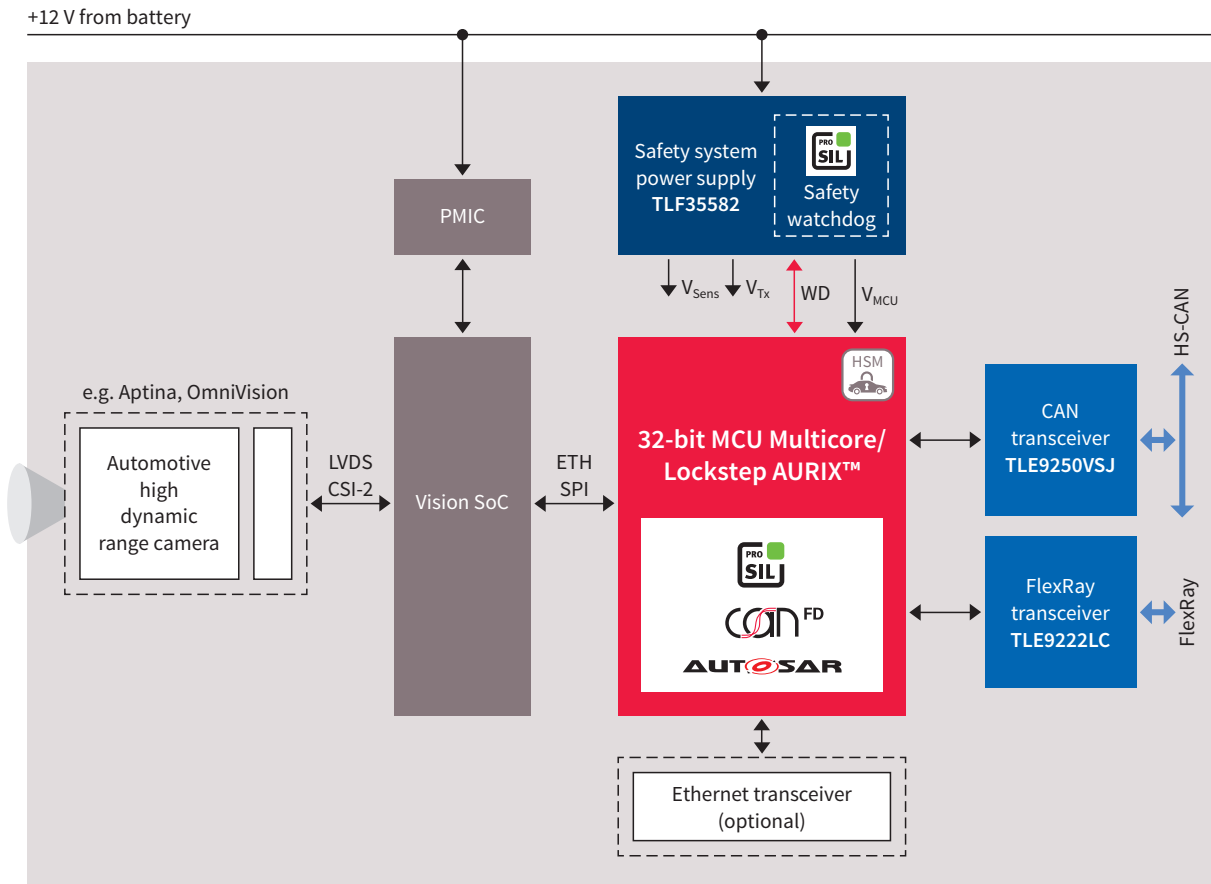

The AURIX™ family will enhance classic safety features with dedicated features to cater for multi-purpose camera systems. Thanks to its rich connectivity, scalable portfolio of performance, eRAM and eFlash, AURIX™ is the ideal companion for the high-performance vision SoC.

Application features

- > TriCore™ DSP functionality
- > Best-in-class performance: up to six TriCore™ with 300 MHz per core
- > Innovative single supply of 5 V or 3.3 V
- > Rich peripherals including Ethernet 100 Mbit/s and 1 Gbit/s, multiple CAN FD, multiple SPIs
- > Portfolio offering up to 6.9 MB embedded RAM
- > External memory interface
- > ISO 26262 conformance to support safety requirements up to ASIL-D

System benefits

- > High scalability option with pin-to-pin compatibility and an identical safety and security concept across the whole family, for easy development and fast go-to-market
- > High integration leads to reduced complexity
- > Innovative supply concept leads to best-in-class power consumption

Suggested products

- > TC233LP
- > TC277TP
- > TC333LP
- > TC367DP
- > TC377TP



Applications

Active suspension control system

Application example

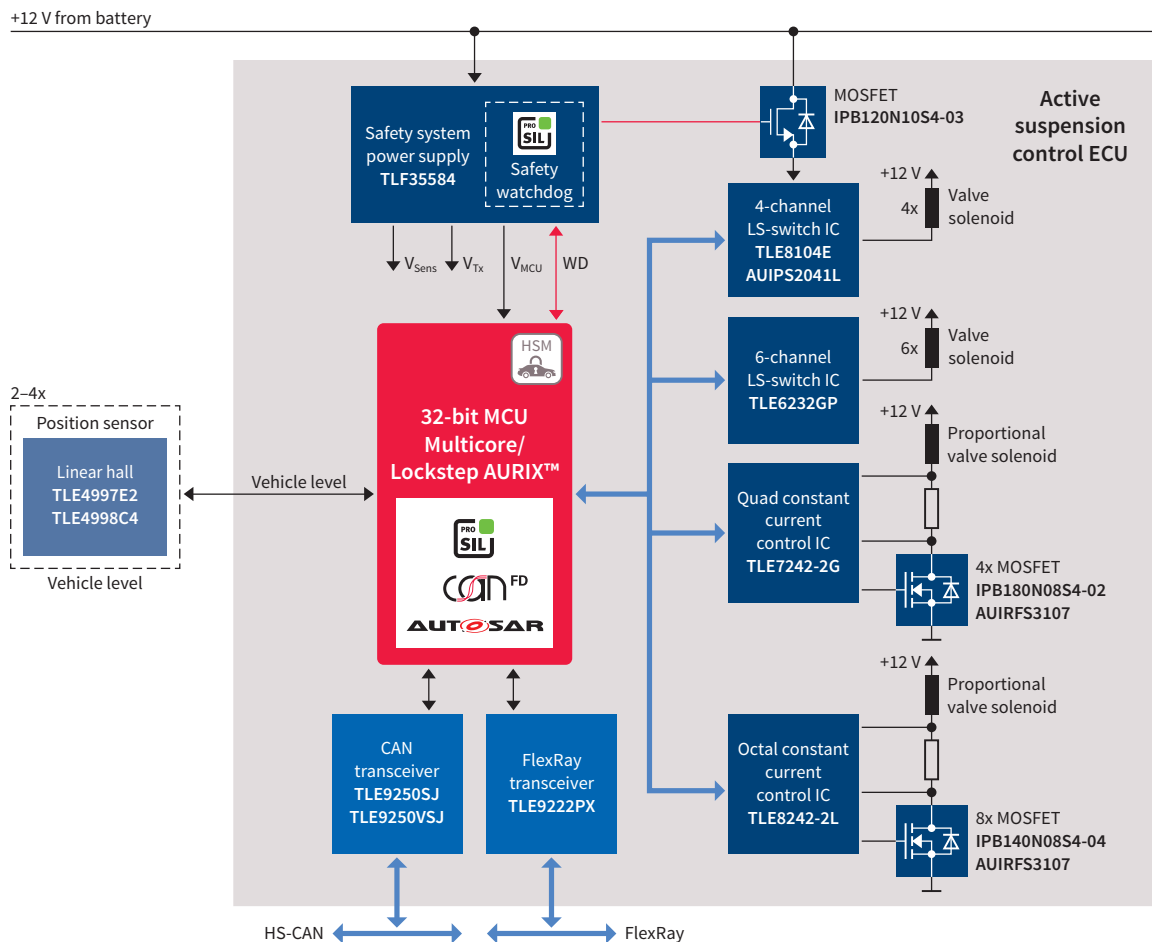

Thanks to its state-of-the-art safety features, the new TriCore™ AURIX™ family enables systems to achieve the highest ASIL-D safety level, which is already required in contemporary suspension systems.

The latest diverse lockstep technology with clock delay (diverse lockstep core) significantly reduces the software overhead and enables fast time-to-market.

The scalability supports an optimized fit in order to meet different OEM specifications.

Application features

- > TriCore™ DSP functionality
- > Best-in-class performance: up to six TriCore™ with 300 MHz per core
- > Supports the floating point and fix point with all cores
- > Up to 6.9 MB
- > Communication peripherals: CAN, LIN, FlexRay, Ethernet
- > Innovative single supply of 5 V or 3.3 V
- > Wide range of packages from 80–516 pin
- > ISO 26262 conformance to support safety requirements up to ASIL-D
- > Availability of AUTOSAR 4.x

System benefits

- > Scalability over flash, RAM and peripherals, offering the best cost-performance ratio
- > Proven safety concept to support ISO 26262
- > Innovative supply concept leads to best-in-class power consumption and saves external component costs

Suggested products

- > TC33x
- > TC36x
- > TC37x



Applications

Airbag system

Application example

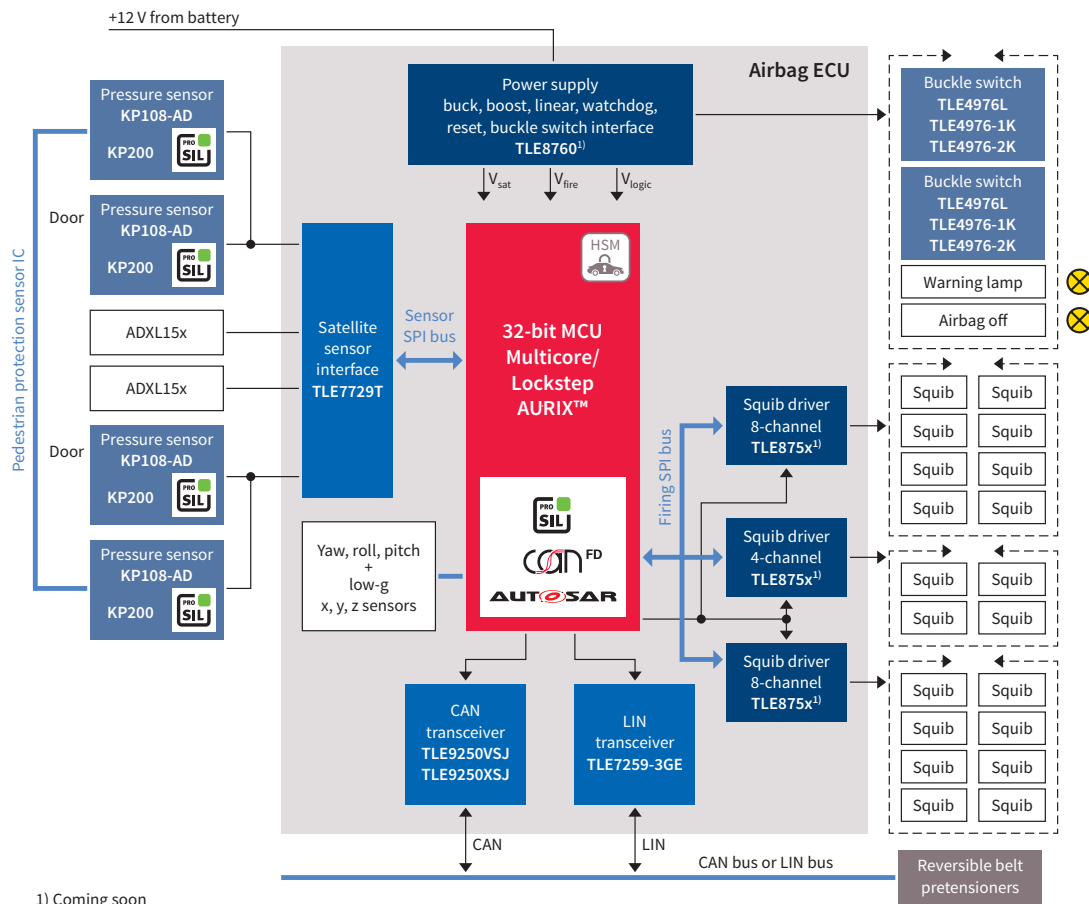

1) Coming soon

Thanks to its state-of-the-art safety features, the new TriCore™ AURIX™ family enables systems to achieve the highest safety level up to ASIL-D. Its scalability allows the selection of a single-core solution for basic airbag systems and multicore solutions for airbag systems with an integrated sensor cluster. The best cost-performance fit is offered by the wide range of flash, performance and peripheral options available within the AURIX™ family.

Application features

- > Scalable flash 1 – 16 MB
- > Performance 160 MHz – 6x 300 MHz
- > Dedicated peripheral set: CAN, LIN, SPI, FlexRay, Ethernet
- > Advanced timer unit, totally flexible PWM generation and hardware input capture
- > Redundant flexible 12-bit ADC
- > Hardware SENT interface for a low CPU load
- > Hardware built-in self-test overhead
- > Safety software: Infineon SafeTcore library
- > ISO 26262 conformance to support safety requirements up to ASIL-D
- > Availability of AUTOSAR 4.x

System benefits

- > Scalability over flash, RAM and peripherals, offering the best cost-performance ratio
- > Serves all kinds of EPS systems, such as column or belt drive
- > Proven safety concept to support ISO 26262
- > Innovative supply concept leads to best-in-class power consumption

Suggested products

- > TC22x
- > TC23x
- > TC32x
- > TC33x
- > TC36x

Applications

Automotive 24 GHz radar system

Application example

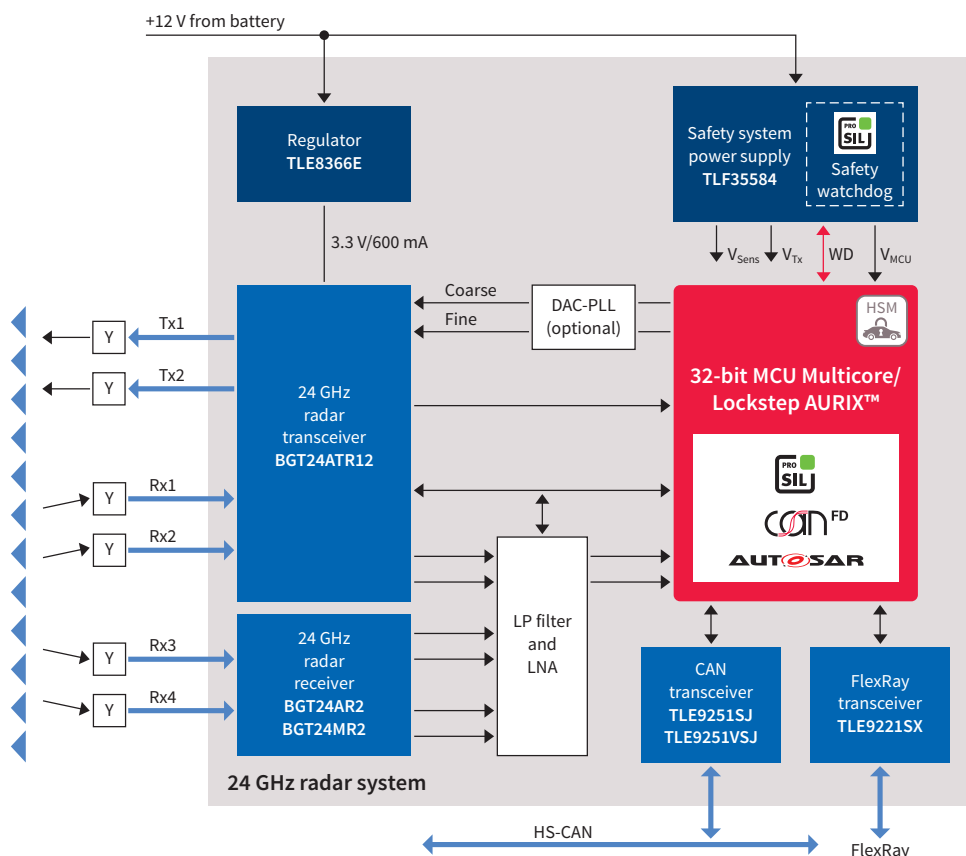

The new TriCore™ AURIX™ family will enhance classic safety features with dedicated features to meet the needs of 24 GHz radar systems. The combination of new features and increased SRAM, in conjunction with outstanding safety features, enables a high level of integration and reduction of complexity.

Application features

- › Up to 752 KB RAM for radar image storage
- › Radar signal processing with windowing functionality
- › Flexibility in radar signal acquisition with 4x internal ADCs
- › Possibility to connect external ADCs (interface to connect up to 16-bit ADCs)
- › High-precision input timers
- › High-precision output timers for DAC
- › Innovative single supply of 5 V or 3.3 V
- › ISO 26262 compliance to support safety requirements up to ASIL-D
- › Availability of AUTOSAR 4.x
- › Continuous, precise and flexible bit-streaming machine (HSPDM) in AURIX™ TC3xx, to replace the external DAC controlling the ramp generator

System benefits

- › High integration leads to significant cost savings
- › High integration leads to reduced complexity
- › ISO 26262 compliance supports safe input for functions such as emergency braking
- › Innovative supply concept
- › Cost savings on the DAC component by using the AURIX™ TC3xx, which integrates the HSPDM IP

Suggested products

- › TC23xLA
- › TC26xDA
- › TC33xDA



Applications

Highly integrated automotive 77 GHz radar chipset

Application example

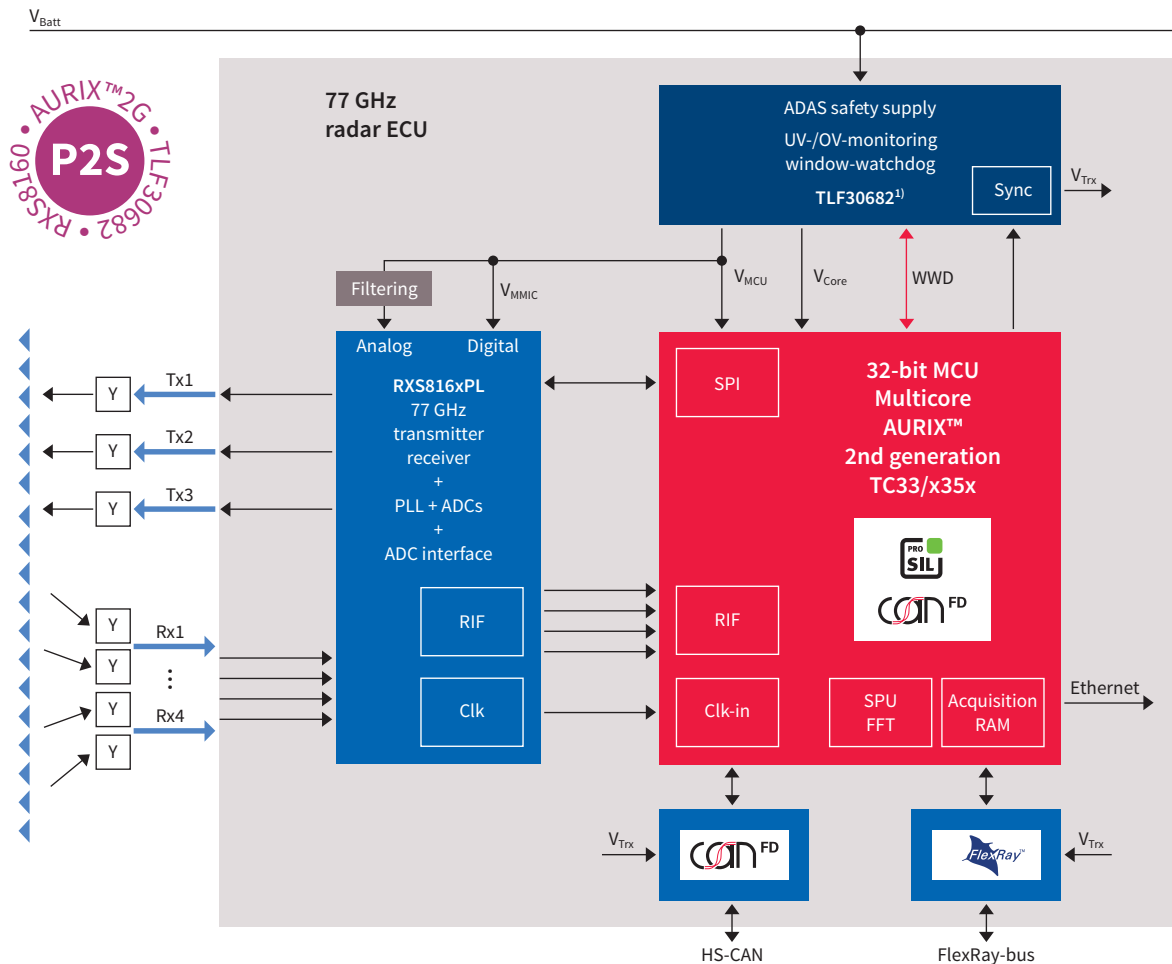

Thanks to its proprietary radar accelerator IP, the new TriCore™ AURIX™ TC3xx family will bring another level of performance to radar applications, as well as fulfilling the ever-growing requirements regarding safety and security in the ADAS market.

Application features

- › TriCore™ DSP functionality
- › Best-in-class performance: up to six TriCore™ with up to 300 MHz per core
- › Dedicated radar cluster with its own radar interface (RIF, LVDS-based) and accelerators (SPU), offering not only FFT but also filtering (CFAR), along with windowing and signal power measures capabilities
- › Up to 4 MB RAM for radar image storage
- › High-precision input timers
- › Innovative single supply of 5 V or 3.3 V
- › External memory interface
- › ISO 26262 compliance to support safety requirements up to ASIL-D
- › Availability of AUTOSAR 4.x

System benefits

- › Family concept with three products for fast go-to-market and scalable radar portfolio
- › Rich features implemented in hardware to attain an optimal performance/consumption ratio and reduce the amount of components, leading to cost savings
- › ISO 26262 compliance supports safe input for functions such as emergency braking

Suggested products

- › TC33xDA
- › TC35xTA
- › TC39xxA
- › TC39XA
- › TC3AxQA

Applications

Sensor fusion

Application examples

Low cost sensor fusion

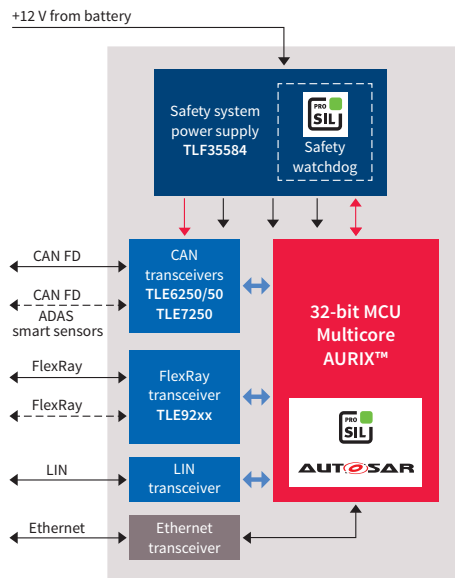

Main stream sensor fusion

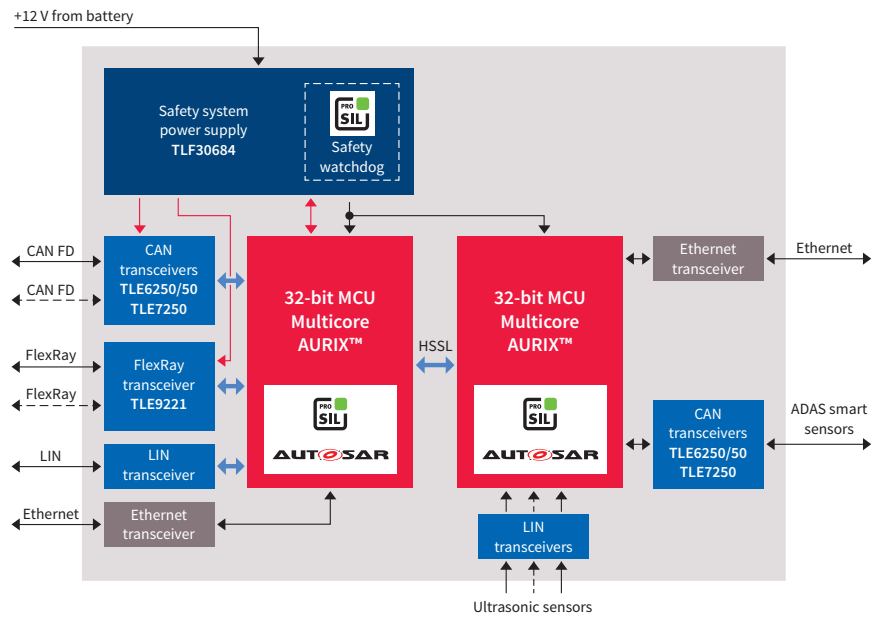

The new TriCore™ AURIX™ TC3xx family offers a scalable product portfolio to address the needs of low-resolution grid fusion applications.

Application features

- > TriCore™ DSP functionality
- > Best-in-class performance: up to six TriCore™ with up to 300 MHz per core, up to 2400 DMIP ASIL-D capable per MCU
- > Up to 4 MB RAM for grid information treatment
- > Up to 16 MB eFlash to support A/B swap SOTA
- > HSSL connectivity for easy coupling of two AURIX™
- > Ethernet up to 1 Gbit/s for fast connection to network and main SoC
- > External memory interface (eMMC) for data logging
- > ISO 26262 compliance to support safety requirements up to ASIL-D
- > Availability of AUTOSAR 4.x

System benefits

- > Family concept with PIN and software compatibility, for maximum re-use and fast go-to-market
- > Low power consumption for compact low/mid-end solutions
- > Rich legacy peripherals (CAN FD, LIN, ...) for integrated gateway application and multi-sensor architecture

Suggested products

- > TC29xTA
- > TC35xTA
- > TC37xTX
- > TC38xQP
- > TC39xXX
- > TC3E7Qx

Applications

Sensor fusion: L2+/-L5

Application example – Domain controller for autonomous drive



The new TriCore™ AURIX™ TC3xx family offers a scalable product portfolio to address the needs of sensor fusion applications, from stand-alone object fusion to companionship for a high-end AD ECU.

Application features

- > TriCore™ DSP functionality
- > Best-in-class performance: up to six TriCore™ with up to 300 MHz per core, up to 2400 DMIP ASIL-D capable per MCU
- > Up to 4 MB RAM for grid information treatment
- > Up to 16 MB eFlash to support A/B swap SOTA
- > HSSL connectivity for direct coupling with SoC
- > Ethernet up to 1 Gbit/s for fast connection to network and SoC
- > External memory interface (eMMC) for data logging
- > ISO 26262 compliance to support safety requirements up to ASIL-D
- > Availability of AUTOSAR 4.x

System benefits

- > Family concept with PIN and software compatibility, for maximum re-use and fast go-to-market
- > Rich legacy peripherals (CAN FD, LIN, ...) for integrated gateway application

Suggested products

- > TC29xTA
- > TC37xTX
- > TC38xQP
- > TC39xXX
- > TC377TX



Applications

AURIX™ for connectivity applications

Connectivity electronics systems embrace a broad variety of applications inside the car, covering comfort, safety and security as well as high-performance computing and in-vehicle networking. **This leads to the key strengths of the AURIX™ family:**

- › **AUTOSAR** – AUTOSAR 4 facilitates the easy design of multicore architectures into vehicles. Infineon is one of the first implementers of a multicore architecture with AURIX™ ready for AUTOSAR 4.x. Furthermore, Infineon also provides the MCAL drivers developed in accordance with the CMM 3 level.
- › **Power consumption** – An innovative supply concept automatically adapts the power consumption to the actual performance requirements. Furthermore, the new trend of pretended networking and ECU degradation is actively supported.
- › **Enhanced communication** – As cars incorporate an increasing amount of electronics, the body electronics module's responsibilities increase to handle the additional components and message traffic. Due to the gateway functionality of the BDC, AURIX™ has enhanced communication capabilities to support communication between CAN FD, LIN, FlexRay and Ethernet buses.
- › **Safety** – The trend is toward the integration of safety targets in the requirements of advanced body systems, such as lighting, BDC etc. To achieve the required ASIL level according to ISO 26262, AURIX™ has the capability to cover targets up to the highest ASIL-D safety integrity level.
- › **Security** – In the future, the need for a high level of security will also expand into body applications. Cars are expected to hold even more information as they become smart cards on wheels for simplifying financial transactions at gas pumps, charging stations, parking lots, toll booths, drive-through shops and more. The vehicle will act as a smart card and pay your fee/fare – sometimes automatically. Hardware-based security is more robust than software-only security. AURIX™ provides a dedicated module, the HSM (Hardware Secure Module), to cover the highest level of security.

Applications

Advanced gateway architecture

Application example



In gateway applications, AURIX™ TC3xx microcontrollers support the latest communications interfaces and feature a Gigabit Ethernet interface, up to 12 ISO 11898-1-compliant CAN FD channels and up to 24 LIN channels. An additional eMMC interface for external flash interfacing enables local data storage, supporting software-over-the-air update concepts.

Application features

- > High-performance processing: up to six-core 300 MHz
- > Automotive up to 2xGB Ethernet
- > Up to 20 CAN FD
- > eMMC for external flash
- > Hardware security module
- > AUTOSAR 4.2 support

System benefits

- > Integrated, cost-efficient solution for a connected gateway with SOTA, secure on-board communication...
- > Fast secure boot
- > Gateway board to reduce the development outlay

Suggested products

- > TC36x
- > TC37x
- > TC3E7
- > TC38x
- > TC39x

Applications

Telematics control unit and V2X

Application example

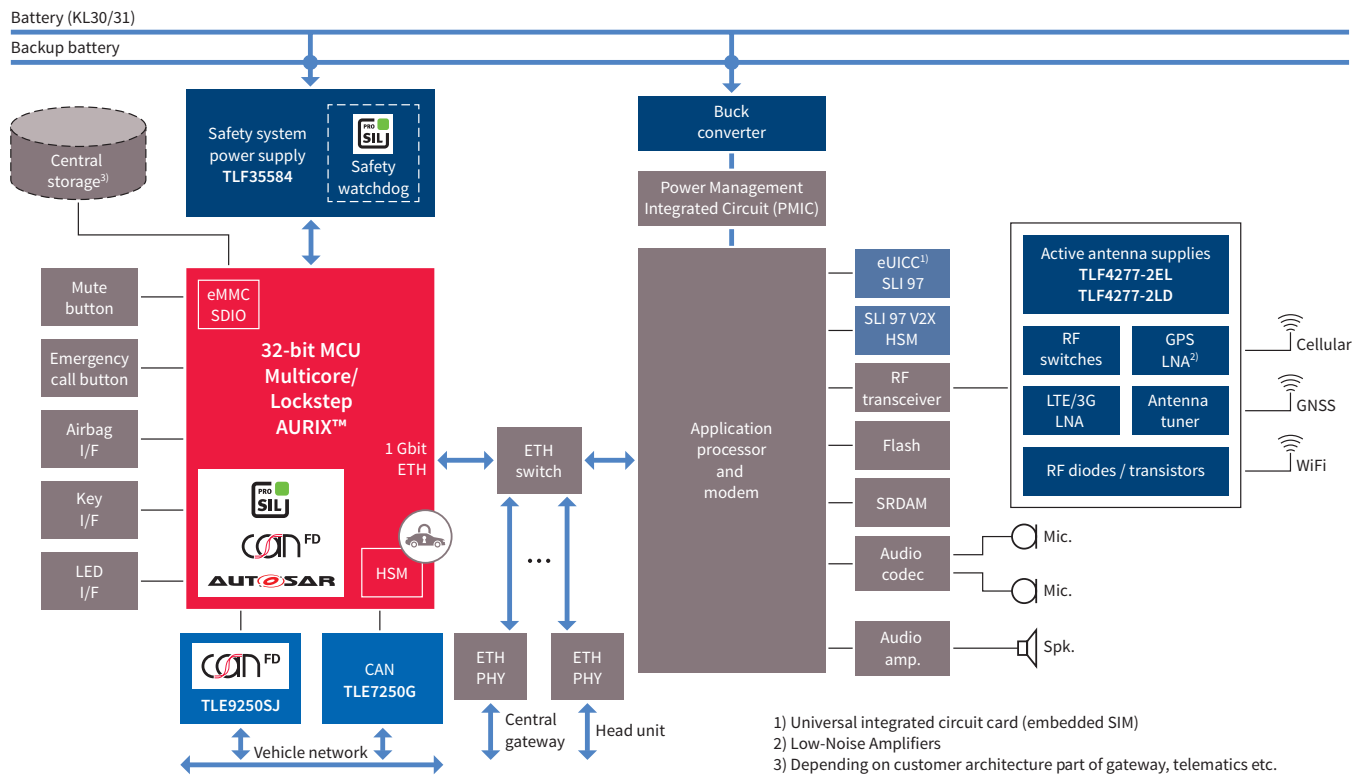

The telematics control unit connects the car to the outside world, thereby enabling numerous new applications and functionalities. Software in different ECUs can be updated remotely, to either add new features or remove any software bugs that might be found during operation. This reduces the number of recalls and related costs, while increasing customer satisfaction. The opportunity to add new features opens up the door to new business models and revenue streams.

Application features

- > eCall
- > Remote diagnostics
- > Payment systems
- > Software update
- > Feature upgrades
- > Internet services
- > etc.

System benefits

- > System supplies, buck converter, active antenna supplies etc.
- > Secure elements (eUICC, OPTIGA™ TPM 2.0, SLI 97 V2X etc.)
- > RF switches, RF diodes/transistors, low-noise amplifiers (GPS, LTE etc.)
- > Silicon microphone

Application features

- > Superior Hardware Security Solution (HSM) + functional safety up to ASIL-D (e.g. eCall, V2x communication, software update of safety-critical ECUs)
- > Automotive and consumer interfaces (incl. CAN/-FD, FlexRay, Ethernet etc.)
- > Highly scalable product portfolio (starting with 2 MB and QFP-100 at the lowest end)

Suggested products

- > TC23x
- > TC33x
- > TC3Ex
- > TC36x
- > TC37x

Applications

High-feature body domain control unit

Application example



Body Domain Control unit (BDC) application comprising internal and external lighting systems, as well as control of relays and voltage rails and further comfort functions such as door and wiper control. The central gateway manages all internal interfaces (i.e. motor management, in-car entertainment, dashboard or convenience control) and communication with external interfaces for after-sales software updates. The AURIX™ multicore concept enables the integration of two applications in one device, e.g. BDC and gateway.

Application features

- › Scalable MCU family from single to multicore
- › Encapsulation feature allows interference-free software development for multiple applications
- › Embedded EEPROM
- › Advanced communication peripherals: CAN, LIN, SPI, FlexRay, Ethernet
- › ISO 26262 conformance to support safety requirements up to ASIL-D
- › Availability of AUTOSAR 4.x

System benefits

- › Enables pretended networking and ECU degradation
- › High integration leads to significant cost savings
- › High integration leads to reduced complexity
- › ISO 26262 compliance supports ASIL requirements
- › Innovative supply concept leads to best-in-class power consumption

Suggested products

- › TC36x
- › TC37x
- › TC38x
- › TC39x
- › TC3E7



Applications

Wireless charger solution

Application example

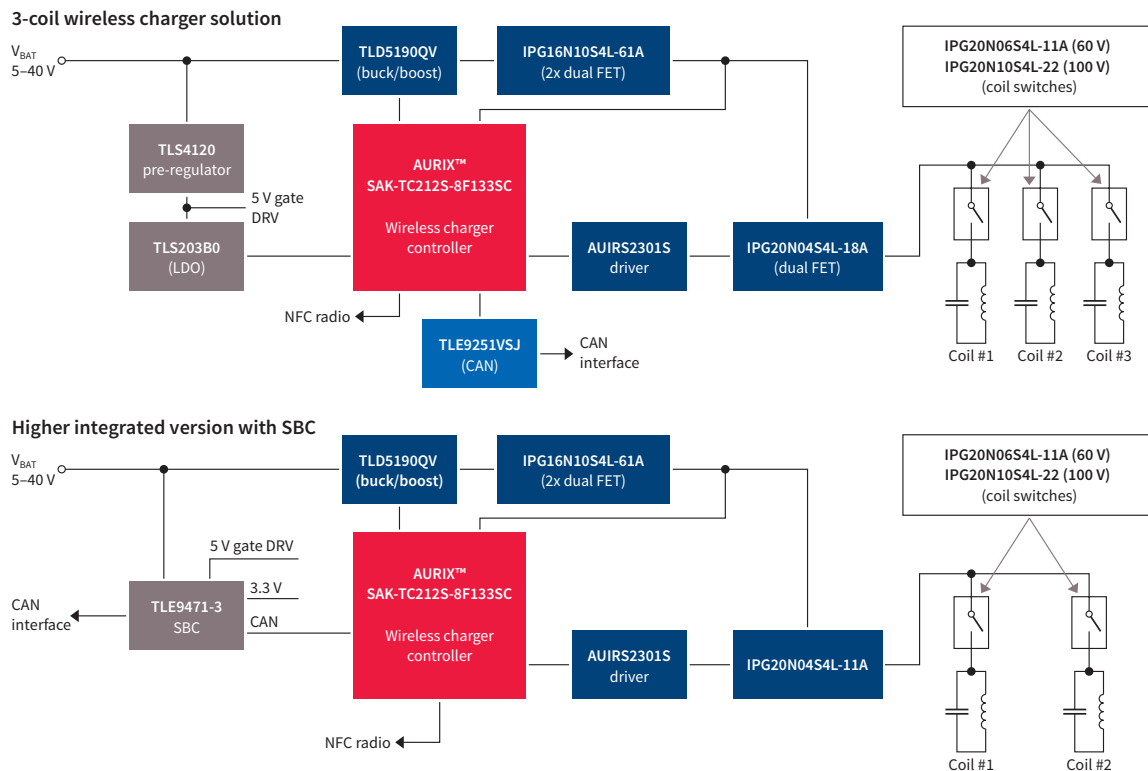

A multi-mode charger with ultimate flexibility

- > High-efficiency 15 W charging without exotic thermal management
- > Multi-mode supporting Q-inverters and fast charge on the same hardware
- > Supports future products and standards with a firmware upgrade
- > Charger is backward compatible with all lower-power and legacy Q-inverters devices
- > Supports single and multi-coil charging surfaces
- > Allows the easy addition of custom features for differentiated applications

Fully compatible with the automotive environment

- > Controlled-frequency operation prevents interference with other systems and reduces EMI
- > Operates on 6–19 V input supply, supporting stop/start
- > Protected from load dump, double battery and reverse battery
- > Supports CAN for integration into the automotive communications infrastructure
- > Full thermal management support, including system monitoring and charge-rate fold back

System benefits

- > Supports greater coil-to-coil Z height than competing solutions
- > A higher efficiency than other solutions means a larger charging “sweet spot”
- > Total front-to-back solution ensures maximum efficiency, minimal thermal impact and ease of certification
- > Reference design is self-protected (load dump, reverse battery etc.)
- > A single AURIX™ supports wireless charging, system application, CAN and external NFC interface functions
- > Can support charging two devices using a single controller
- > Built-in security functionality meets the latest automotive requirements
- > Proven fixed frequency/variable voltage hardware and software architecture
- > Proven EMI performance
- > Certified WPC 1.2.2 (15 W) on multiple previous products

Suggested products

- > TC21x
- > TC22x
- > TC23x

Applications

Pixel lighting

Application example



The new TriCore™ AURIX™ TC3xx family offers a scalable product portfolio to address low to high-definition safe headlight systems.

Application features

- > TriCore™ DSP functionality
- > Best-in-class performance: up to six TriCore™ with up to 300 MHz per core
- > Complete family qualified for automotive grade 0
- > Up to 6.9 MB RAM for light distribution processing
- > Up to 16 MB eFlash to support A/B swap SOTA
- > GTM cluster to emulate the main peripheral protocols of this market
- > Ethernet up to 1 Gbit/s for fast connection to network
- > External memory interface (eMMC) for data logging
- > Availability of AUTOSAR 4.x

System benefits

- > Enables smart headlight solutions , to save connectivity costs
- > Family concept with PIN and software compatibility, for maximum portfolio scalability, re-use and fast go-to-market
- > Compatibility with all major headlight driver solutions
- > Rich legacy peripherals (CAN FD, LIN, ...)

Suggested products

- > TC367DP
- > TC377TP/X
- > TC387QP
- > TC397XP/X





Applications

Commercial and Agricultural Vehicles (CAV)

AURIX™ is Infineon's brand-new family of microcontrollers, designed to precisely meet the needs of the 24–60 V industry in terms of performance, memory, scalability, safety and security.

Its innovative multicore architecture supports the latest trends in connectivity, such as Ethernet and CAN FD, as well as safety (IEC 61508/ISO 25119/ISO 26262) and security.

While supporting a high performance, the innovative supply concept with integrated DC-DC converter leads to best-in-class power consumption.

The scalable AURIX™ family leads to the most optimized cost-performance application fit.

AURIX™ addresses CAV requirements and challenges

External memory extension	Lots of IOs	Safety
<ul style="list-style-type: none"> > Expensive external RAMs > Short life cycles > Design complexity > No memory integrity support 	<ul style="list-style-type: none"> > Hundreds of valves, actuators and LEDs > Many analog signals to be measured > Communication interfaces 	<ul style="list-style-type: none"> > Increasingly rigorous safety standards > Expensive dual-channel approach > Tedious work until certification
<ul style="list-style-type: none"> > Special devices with extended SRAM > Up to 2.7 MB SRAM 	<ul style="list-style-type: none"> > Different packages up to 516 pins > Multiple ADCs, communication interfaces 	<ul style="list-style-type: none"> > IEC 61508 family safety concept > Lockstep > Safety support

Applications

Hydraulic/pneumatic management system

CAVs are under mounting pressure to provide highest possible availability and lowest-possible operating costs as operators strive to maximize profits. Hydraulic or pneumatic system are key applications toward such targets, providing great reliability and low operational cost. The new TriCore™ AURIX™ TC3xx family offers a scalable product portfolio to address all the demands for valve control management. carry out a variety of protective and diagnostic functions.



Hydraulic system overview



Hydraulic management system has to be precise and robust enough to withstand harsh environments and engineered to carry out a variety of protective and diagnostic functions.

Application features

- > Valves and pumps can be driven via linear activation or demand-controlled via PWM signals
- > Integrated solution reduces the design outlay
- > Pin-to-pin and software compatibility
- > AECQ-100 qualified

Suggested products

- > TC32x
- > TC33x > TC36x
- > TC37x

Key benefits

- > AURIX™ advanced timer unit for dynamic PWM generation and hardware input capture
- > Scalability over flash, RAM and peripherals, offering the best cost-performance ratio
- > High microcontroller junction bare die temperature to withstand high temperature environments.
- > AURIX™ safety requirements supported up ISO 26262 ASIL-D



Pneumatic system overview



Pneumatic management system is typically chosen for its cost effectiveness and ease of integration (no need for a reservoir) compared to its hydraulic counterpart.

Application features

- > Valves and pumps can be driven via linear activation or demand-controlled via PWM signals
- > Integrated solution reduces the design outlay
- > Pin-to-pin and software compatibility
- > AECQ-100 qualified

Key benefits

- > AURIX™ advanced timer unit for dynamic PWM generation and hardware input capture
- > Scalability over flash, RAM and peripherals, offering the best cost-performance ratio
- > High microcontroller junction bare die temperature to withstand high temperature environments.
- > AURIX™ safety requirements supported up to ISO 26262 ASIL-D

Suggested products

- > TC32x
- > TC33x
- > TC36x
- > TC37x

Applications

Radar 24 GHz

Application example



Self-driving technologies have the potential to revolutionize the CAV sector. Driverless machines can operate 24/7 – whether on a construction site or the freeway. Autonomous systems eliminate the need for downtime as well as the most common cause of accidents: people. In agriculture, autonomous tractors can spread fertilizer and plant seeds with utmost precision. The new TriCore™ AURIX™ family will enhance classic safety features with dedicated features to meet the needs of 24 GHz radar systems.

Application features

- › High integration leads to significant cost savings
- › Small PCB footprint
- › Hardware compliance with ISO 61508 up to SIL 3 supports safe input for functions such as emergency braking
- › Low cost in BOM as the AURIX™ microcontroller replaces additional DSP and external memory

Suggested products

- › TC23xLA
- › TC26xDA
- › TC33xDA

Key benefits

- › Up to 752 KB RAM for radar image storage
- › Radar signal processing with windowing functionality
- › Flexibility in radar signal acquisition with 4x internal ADCs
- › Possibility to connect external ADCs (interface to connect up to 16-bit ADCs)
- › High-precision input/output timers
- › ISO 26262 compliance to support safety requirements up to ASIL-D
- › Continuous, precise and flexible bit-streaming machine (HSPDM) in AURIX™ TC3xx, to replace the external DAC controlling the ramp generator



Applications

Gateway 24 V

Application example



Not different from a passenger cars, in order to comply with Megatrends like CO₂ emissions, ADAS and Connectivity, CAVs need sophisticated systems which can offer cost efficient and high performant computational power. Such requirements demand high complexity E/E architectures with respect to in-vehicle communication networks, power networks, connectivity, safety and security. In order to reliably and securely transfer different types of data through different network protocols, CAVs make use of a Gateway controller, which perform as a hub among all the functional domains that share data. The high computing performance and multiple connectivity interfaces of the new TriCore™ AURIX™ family makes it the ideal microcontroller for gateway applications.

Application features

- > 24 V compliant gateway
- > Enable high complexity E/E architectures
- > Data transfer across different functional domains working in different network protocols
- > Gateway board to reduce the development outlay

Suggested products

- > TC37x
- > TC39x

Key benefits

- > AURIX™ computing performance, flexibility, scalability, integrated safety and security support
- > AURIX™ multiple connectivity capabilities, including up to 2 Gigabit Ethernet interfaces
- > High integration leads to significant cost savings and reduced complexity
- > AURIX™ Hardware Security Solution (HSM) provides the highest level of security
- > Hardware compliance with ISO 26262 up to ASIL-D



Applications

In cabin wireless charging

Application example

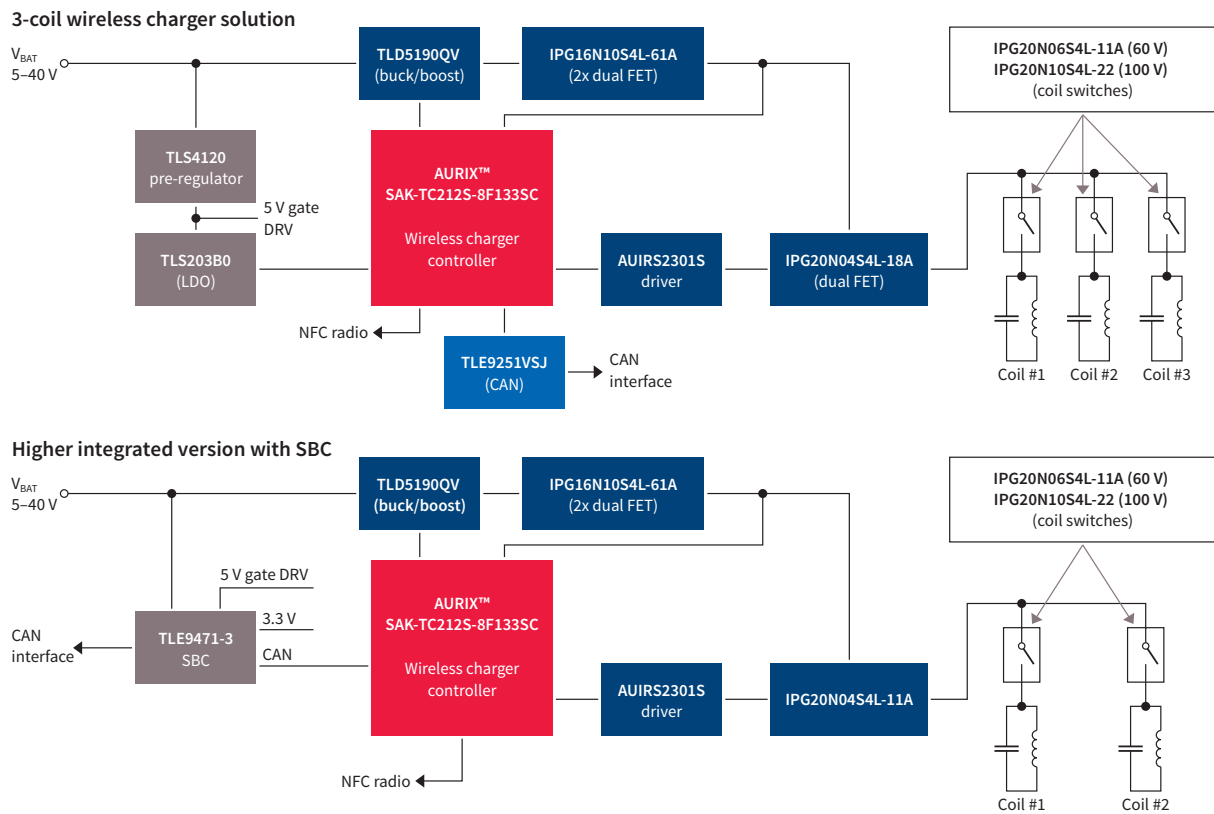

As farmers seek to increase crop yields, access to data that like field mapping, planting calculations, spray logs, soil sampling tools and weather predictions, can help them make decisions to maximize output. However, none of this would be possible if, after a long travel to the field, their tablet, phone, personal computer or even a necessary Powertool runs out of battery. Therefore, Infineon has developed a wireless power controller system using AURIX™ family microcontrollers that helps the next-generation wireless charging systems meet strict safety, environmental and regulatory requirements, while still enabling industry-leading charging performance and efficiency in a CAV environment (e.g. armrest of a tractor).

Key features

- > High-efficiency 15 W charging without exotic thermal management
- > Multi-mode supporting Q-inverters and fast charge on the same hardware
- > Supports single and multi-coil charging surfaces
- > Allows the easy addition of custom features for differentiated applications

Suggested products

- > TC212S-8F133SC

System benefits

- > Supports greater coil-to-coil Z height than competing solutions
- > Total front-to-back solution ensures maximum efficiency, minimal thermal impact and ease of certification
- > A single AURIX™ device supports wireless charging, system application, CAN and external NFC interface functions
- > One AURIX™ controller can support charging two devices at the same time
- > Built-in security functionality meets the latest CAV/automotive requirements
- > Proven fixed frequency/variable voltage hardware and software architecture
- > Proven EMI performance
- > Certified WPC 1.2.2 (15 W)

Applications

Drones/multicopter

Application example



Infineon's comprehensive portfolio of high-quality products contains the widest spectrum of multicopter components on the market. We offer everything from industrial XMC™ controllers to the AURIX™ family, supporting everything from motor control of the rotors to autonomous flying support with 24 GHz radar. Thanks to an optimized feature set, we can support both consumer (XMC™ family) and commercial drones (AURIX™ family). The new safety requirements can be covered with the AURIX™ family which supports IEC 61508/SIL-3 and ISO 26262/ASIL-D.

Applications

Drones/multicopter

Application example



Application features

- > Commercial drone solution based on AURIX™ family
- > Decentralized architecture
- > Single chip solution – AURIX™ for flight control, motor control, radar sensors, BMS and power conversion providing optimum balance between BOM cost and performance

Suggested products

- > TC37x
- > TC39x

Key benefits

- > Dedicated motor control unit using AURIX™ CCU6 & GTM for fine motor tuning, as well as multicore architecture to drive several motor per device
- > Redundant sensors input for safety and sensor fusion enabling a smooth and precise flight control
- > AURIX™ functional safety capabilities compliant with IEC 61508 SIL 3
- > AURIX™ Hardware Security Module (HSM) provides secure authentication for original parts, protection against manipulation and secure SOTA software updates.
- > 24 GHz radar can be used to measure the presence of objects, measure the range, speed/velocity, ascertain proximity, and determine the position of objects



Applications

AURIX™ for industrial applications

AURIX™ for high-performance, multicore and safety-demanding applications

The AURIX™ 32-bit microcontroller family is based on the Infineon TriCore™ high-performance core concept and provides a highly scalable family from single core to multicore.

The AURIX™ family enables the highest integrated safe memory sizes (SRAM up to 6.9 MB and flash memory up to 16 MB) and all memory is protected by hardware Error Correction Code (ECC). The devices reach more than 600 DMIPS at clock rates of up to 6x 300 MHz and combine MCU and DSP instructions with an integrated FPU.

The integrated peripheral set is primarily targeted toward motor control and power conversion, providing high-performance ADCs, DS ADCs and a full set of diverse high-performance timers. This is one of the very few in the industry that is able to drive the upcoming three-level inverter topologies. Furthermore, the AURIX™ family supports the latest connectivity, such as Ethernet, CAN FD, FlexRay and multiple other high-speed interfaces.

Providing security and functional safety

In a global economy, IP protection and secure communication plays an increasingly important role. This demand is accounted for by the integration of special security modules providing the required means of safe key storage, along with secure boot and encryption on the hardware level. As one of the leaders in functional safety, Infineon has designed the TriCore™ MCUs to meet the growing demand for functional safety in the industrial market as specified in IEC 61508. Via our cooperation partner Hitex, Infineon offers a complete package comprising a microcontroller, safety supply with integrated watchdog TLF35584, software and documentation, achieving safety integrity levels up to SIL3.

The new generation of TriCore™-based microcontrollers – AURIX™ – provides another significant performance milestone by integrating up to six cores in one device. The multicore concept is targeted at running concurrent applications in parallel. Some of the integrated cores integrate lockstep functionality and the peripherals can be allocated to individual cores. This facilitates running a combination of safety-critical tasks, such as controlling an inverter, with non-critical tasks, such as network communication, on a single MCU.

Applications

Infineon Microcontrollers for industrial applications

Infineon has combined its wealth of experience in microcontroller design to offer a wide portfolio that can cover a broad range of industrial applications. It is based on:

- > The XMC™ family for real-time critical applications where an industry-standard core is needed
- > The AURIX™ family for applications where more performance, connectivity, safety and security are needed



1) AURIX™ devices add safety and CAN FD

Applications

Servo drives

Application example



Application features

- > High computing performances
- > High level of accuracy, integration and efficiency
- > Safety management in line with current norms
- > Supports a different variant of drives portfolio
- > Security features that protect intellectual property from counterfeiting

Suggested products

- > TC26x
- > TC27x
- > TC29xT
- > TC33x
- > TC36x
- > TC37x
- > TC38x
- > TC39x
- > XMC1000
- > XMC44xx

System benefits

- > Scalable portfolio
- > High computing performance thanks to multicore architecture
- > Ability to drive numerous servo motors
- > High flexibility thanks to tailored peripherals
- > Integrated safety support
- > Integrated security with hardware security module
- > Large portfolio with long-term availability

Applications

Industrial robotics

Application example



Application features

- > High computing performances
- > High level of accuracy, integration and efficiency
- > Safety management in line with current norms
- > Various topologies for axes, joints and motors
- > Security features that protect intellectual property from counterfeiting

Suggested products

- > TC23x
- > TC33x
- > TC36x
- > TC37x
- > TC38x
- > TC39x
- > XMC4xxx

System benefits

- > High computing performance: up to 6x 300 MHz
- > High flexibility thanks to tailored peripherals
- > Integrated safety support (EN ISO 10218 and ISO/TS15066)
- > Integrated security with hardware security module
- > Robust 3 V-, 5 V-, LVDS – PortPins
- > Large portfolio with long-term availability



Applications

Industrial motor drives

Application example



Industrial motor drives have become more and more sophisticated over the years as they have to drive different motors, a large amount of sensors and communication requirements. But beyond those, Safety becomes key to protect the humans interacting with the machines. Therefore are various redundancy mechanisms required. This is what AURIX™ portfolio offers combined with high reliability and long lifetime management.

Key benefits

- > Dedicated motor control units: CCU6 & GTM for fine motor tuning
- > Redundant sensors input for safety and sensor fusion
- > DS-ADC-enabled direct resolver to microcontroller
- > Numerous ADC inputs
- > BOM saving
- > Multicore architecture to drive several motor per device
- > Emergency STOP

Suggested products

- > **TC2xx:** TC21x, TC22x, TC23x, TC26x, TC27x, TC29x
- > **TC3xx:** TC32x, TC33x, TC35x, TC36x, TC37x, TC38x, TC39x

Applications

Elevators

Application example



Modern elevators have strong safety requirements. The new TriCore™ family AURIX™ with state-of-the-art safety features enables your system to meet the highest safety levels that are required in your system.

Combining AURIX™ and XMC™ families from Infineon is enabling you a power-ful solution that will reduce your software overhead signifi-cantly and help your fast time-to-market.

Application features

- > Multiprocessor support for reliability and safety
- > Platform concept to allow extensive customization
- > Up to 12 CAN for communication in system
- > External bus interface (32-bit) with cache
- > SRAM up to 6.9 MB
- > Flash up to 16 MB
- > Long-term availability

Suggested products

- > AURIX™: TC33x, TC36x, TC37x, TC38x, TC39x
- > XMC™: XMC14xx, XMC4xxx

System benefits

- > High computing performance: up to 6x 300 MHz
- > Scalable family with compatibility: SW, pin-out
- > High-speed asymmetric single/dual/triple core
- > Up to 12 CAN or CAN FD nodes
- > Resolver I/F
- > Encoder I/F with digital noise filter
- > Safety requirements supported up to IEC 61508/SIL-3

Applications

Inverters

Application example



Inverters are key components and, regardless of whether the motor is synchronous, asynchronous or brushless DC, the inverter always functions in a similar way and is controlled by an integrated PCB, which should be designed to minimize switching losses and maximize thermal efficiency. Infineon is providing you solutions to support those requirements.s

Application features

- > Multi-axis controller for two 3-phase complementary PWMs
- > Multiple modulation strategies (SVPWM, DPWM, soft-PWM, direct torque control) to support requirements aimed at reducing noise emissions and increasing efficiency
- > Ready for four Q-inverters, matrix-inverters
- > Field-oriented control with less than 10% CPU load
- > Multiprocessor support for reliability and safety
- > Support for 3-level inverter topologies
- > High computing performance up to 6x 300 MHz
- > Up to 6.9 MB internal RAM

System benefits

- > Scalable and compatible portfolio
- > Diverse high-performance timer architectures
- > Up to 12 SAR-ADCs 12-bit resolution
- > Up to 14 DS-ADC
- > Resolver I/F
- > Encoder I/F with digital noise filter
- > Very fast control loop
- > IEC 61508 support – Safety Integrity Level (SIL) 1 to 3
- > Innovative single power supply concept
- > Large portfolio with long-term availability

Suggested products

- > TC33x
- > TC36x
- > TC37x
- > TC38x
- > TC39x

Applications

Wind turbines

Application example

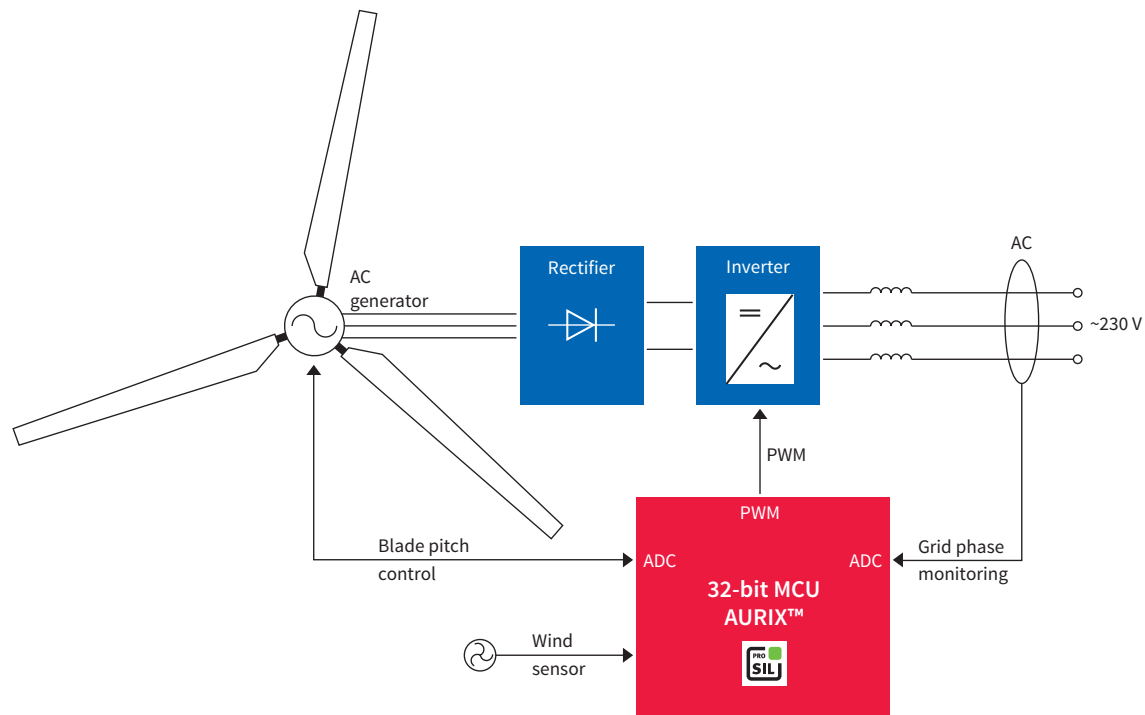

New sources of renewable energy, such as wind, are increasing to meet growing demand while helping reduce CO₂ emissions. In parallel, generation and distribution are driven by strong innovation requirements that can be fulfilled with our strong portfolio. Our microcontrollers can support the high level of connectivity and dataflow required as well as efficiently manage the high power energy generated with the best cost – performance ratio.

Application features

- › Reliable blade pitch control
- › Increased wind turbine efficiency
- › Multiple modulation strategies (SVPWM, DPWM, soft-PWM, direct torque control) to support requirements aimed at reducing noise emissions and increasing efficiency
- › Multiprocessor support for reliability and safety
- › Support for 3-level inverter topologies

Suggested products

- › TC33x
- › TC36x
- › TC37x
- › TC38x
- › TC39x

System benefits

- › Scalable and compatible portfolio
- › Diverse high-performance timer architectures
- › Up to 12 SAR-ADCs 12-bit resolution
- › Up to 14 DS-ADC
- › Resolver I/F
- › Encoder I/F with digital noise filter
- › IEC 61508 support – Safety Integrity Level (SIL) 1 to 3
- › Large portfolio with long-term availability



Applications

Solar panels

Application example



Renewable energy standards require a certain amount of the energy produced to be generated from renewable sources such as wind and solar. Some countries include some more specific requirements which further incentivize the deployment of particular energy technologies. In this context, there is an increasing demand for solar power generation systems.

Application features

- > Multi-phase PWM controller for single or multiple strings
- > Multiple modulation strategies (SVPWM, DPWM, soft-PWM, direct torque control) to support requirements aimed at reducing noise emissions and increasing efficiency
- > Maximum Power Point Tracking (MPPT) to extract maximum power from solar panels
- > Grid phase monitoring and synchronization to ensure power factor unity
- > Current control to avoid disharmony and determine the feed-in refund
- > Support for 3-level inverter topologies

System benefits

- > Scalable and compatible portfolio
- > Diverse high-performance timer architectures
- > Up to 12 SAR-ADCs 12-bit resolution
- > Up to 14 DS-ADC
- > Resolver I/F
- > Encoder I/F with digital noise filter
- > IEC 61508 support – Safety Integrity Level (SIL) 1 to 3
- > DSP library available
- > Large portfolio with long-term availability

Suggested products

- > TC33x
- > TC36x
- > TC37x
- > TC38x
- > TC39x

Applications

Safe PLC

Application example

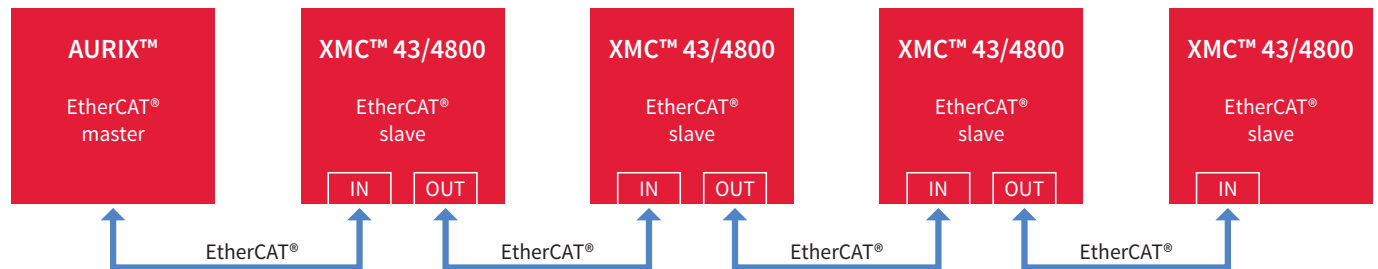

At the heart of most industrial control and factory automation systems is a programmable logic controller (PLC). Commonly referred to as the “brain” of a factory, a PLC controls a wide range of functions by receiving and processing data from sensors and machines. It then uses this data to control and actuate external devices. Because it’s used in industrial applications, a PLC must be robust. Moreover, a successful design must offer reliability, system stability and 100% interoperability with connected automation systems.

Key benefits

- > AURIX™ as EtherCAT® master
 - SW development via PDH RT labs
 - Safety IEC 61508 (SIL3) high performance
 - Scalability and SW reusability across family
- > XMC™ as EtherCAT® slave controller
 - Certified software available with no license cost
 - No additional external component required
 - BOM and PCB savings
 - Enablement of EtherCAT® technology in harsh environment with 125°C ambient temperature

Suggested products

- > AURIX™ TC2xx
- > AURIX™ TC3xx
- > XMC™ 43xx
- > XMC™ 48xx

TriCore™/AURIX™ software and tool partner ecosystem

AURIX™

Embedded software RTOS and AUTOSAR



Modelling, simulation and virtual prototyping



Integrated Compiler Environments



Software automation and auto code generation



Timing and scheduling analysis



Flash tools and programming services



Debugger, test and verification



Data measurement, calibration and rapid prototyping



Software verification and rule checker



Evaluation boards and SDKs



Training and engineering services



Free tools and software





Feature overview AURIX™ family

TriCore™ microcontroller

Product type	Max clock frequency [MHz]	Program memory [KByte]	SRAM (incl. cache) [KByte]	Co-processor ¹⁾	Cores/lockstep	Timed I/O GPIO	Number of ADC channels	External bus interface	CAN/CAN FD nodes	Communication interfaces ²⁾	Temperature ranges ³⁾	Packages	Additional features/remarks ⁴⁾
AURIX™ TC2xx family													
TC299TX	300	8000	2728	FPU	3/1	263	84/10 DS	Yes	6	4x ASCLIN, 6x QSPI, 3x MSC, 2x I ² C, 15x SENT, HSSL, 5x PSi5, 2x FlexRay, Ethernet	K	LFBGA-516	EVR, WUT, HSM
TC299TP	300	8000	728	FPU	3/1	263	84/10 DS	Yes	6	4x ASCLIN, 6x QSPI, 3x MSC, 2x I ² C, 15x SENT, HSSL, 5x PSi5, 2x FlexRay, Ethernet, CAN FD	K	LFBGA-516	EVR, WUT, HSM
TC298TP	300	8000	728	FPU	3/1	232	60/10 DS	Yes	6	4x ASCLIN, 6x QSPI, 3x MSC, 2x I ² C, 15x SENT, HSSL, 5x PSi5, 2x FlexRay, Ethernet	K	LBGA-416	EVR, WUT, HSM
TC297TA	300	8000	2728	FPU, FFT, CIF	3/1	169	60/10 DS	No	6	4x ASCLIN, 6x QSPI, 3x MSC, 2x I ² C, 15x SENT, HSSL, 5x PSi5, 2x FlexRay, Ethernet	K	LFBGA-292	EVR, WUT, HSM
TC297TX	300	8000	2728	FPU	3/1	263	60/10 DS	No	6	4x ASCLIN, 6x QSPI, 3x MSC, 2x I ² C, 15x SENT, HSSL, 5x PSi5, 2x FlexRay, Ethernet	K	LFBGA-292	EVR, WUT, HSM
TC297TP	300	8000	728	FPU	3/1	169	60/10 DS	No	6	4x ASCLIN, 6x QSPI, 3x MSC, 2x I ² C, 15x SENT, HSSL, 5x PSi5, 2x FlexRay, Ethernet, CAN FD	K	LFBGA-292	EVR, WUT, HSM
TC277TP	200	4000	472	FPU	3/2	169	60/6 DS	No	4	4x ASCLIN, 4x QSPI, 2x MSC, HSSL, I ² C, 10x SENT, 3x PSi5, FlexRay, Ethernet, CAN FD	K	LFBGA-292	EVR, WUT, HSM
TC275TP	200	4000	472	FPU	3/2	112	48/6 DS	No	4	4x ASCLIN, 4x QSPI, 2x MSC, HSSL, I ² C, 10x SENT, 3x PSi5, FlexRay, Ethernet, CAN FD	K	LQFP-176	EVR, WUT, HSM
TC267D	200	2500	240	FPU	02/1	169	50/3 DS	No	5	4x ASCLIN, 4x QSPI, 2x MSC, I ² C, 10x SENT, 3x PSi5, HSSL, FlexRay, Ethernet, CAN FD	K	LFBGA-292	EVR, WUT
TC265D	200	2500	240	FPU	2/1	112	50/3 DS	No	5	4x ASCLIN, 4x QSPI, 2x MSC, I ² C, 10x SENT, HSSL, 3x PSi5, FlexRay, Ethernet, CAN FD	K	LQFP-176	EVR, WUT
TC264DA	200	2500	752	FPU, FFT, CIF	2/1	88	40/3 DS	No	5	4x ASCLIN, 4x QSPI, 2x MSC, I ² C, 10x SENT, HSSL, 3x PSi5, FlexRay, Ethernet, CAN FD	K	LQFP-144	EVR, WUT
TC264D	200	2500	240	FPU	2/1	88	40/3 DS	No	5	4x ASCLIN, 4x QSPI, 2x MSC, I ² C, 10x SENT, HSSL, 3x PSi5, FlexRay, Ethernet, CAN FD	K	LQFP-144	EVR, WUT
TC237LP	200	2000	192	FPU	1/1	120	24	No	6	2x ASCLIN, 4x QSPI, 4x SENT, FlexRay, CAN FD	K	LFBGA-292	EVR, WUT, HSM
TC234LA	200	2000	704	FPU, FFT	1/1	120	24	No	6	2x ASCLIN, 4x QSPI, 4x SENT, FlexRay, Ethernet	K	TQFP-144	EVR, WUT, HSM
TC234LX	200	2000	704	FPU	1/1	120	24	No	6	2x ASCLIN, 4x QSPI, 4x SENT, FlexRay, Ethernet	K	TQFP-144	EVR, WUT, HSM
TC234LP	200	2000	192	FPU	1/1	120	24	No	6	2x ASCLIN, 4x QSPI, 4x SENT, FlexRay, CAN FD	K	TQFP-144	EVR, WUT, HSM
TC233LP	200	2000	192	FPU	1/1	78	24	No	6	2x ASCLIN, 4x QSPI, 4x SENT, FlexRay, CAN FD	K	TQFP-100	EVR, WUT, HSM
TC224L	133	1000	96	FPU	1/1	120	24	No	3	2x ASCLIN, 4x QSPI, 4x SENT	K	TQFP-144	EVR, WUT
TC223L	133	1000	96	FPU	1/1	78	24	No	3	2x ASCLIN, 4x QSPI, 4x SENT	K	TQFP-100	EVR, WUT
TC222L	133	1000	96	FPU	1/1	59	14	No	3	2x ASCLIN, 4x QSPI, 4x SENT	K	TQFP-80	EVR, WUT
TC214L	133	500	96	FPU	1/1	120	24	No	3	2x ASCLIN, 4x QSPI, 4x SENT	K	TQFP-144	EVR, WUT
TC213L	133	500	96	FPU	1/1	78	24	No	3	2x ASCLIN, 4x QSPI, 4x SENT	K	TQFP-100	EVR, WUT
TC212L	133	500	96	FPU	1/1	59	14	No	3	2x ASCLIN, 4x QSPI, 4x SENT	K	TQFP-80	EVR, WUT

1) CIF = Camera and external ADC interface, FFT = Fast Fourier Transform Accelerator, FPU = Floating Point Unit, PCP = Peripheral Control Processor

2) ASC = Asynchronous Serial Channel, ASCLIN = Asyn/Synchronous Local Interconnect Network, HSSL = High Speed Serial Link, I²C = Inter-Integrated Circuit, LIN = Local Interconnect Network, MLI = Micro Link Interface, MSC = Micro Second Channel, PSi5 = Peripheral Sensor Interface 5, QSPI = Queued Serial Peripheral Interface, SENT = Single Edge Nibble Transmission, SSC = Synchronous Serial Channel

3) Ambient temperature range: A = -40 ... 140°C, B = 0 ... 70°C, F = -40 ... 85°C, H = -40 ... 110°C, K = -40 ... 125°C, L = -40 ... 150°C, X = -40 ... 105°C

4) EVR = Embedded Voltage Regulator, HSM = Hardware Security Module, WUT = Wake-Up Timer

TriCore™ microcontroller

Product type	Cores/lockstep	Max clock frequency [MHz]	Program memory [KByte]	SRAM (incl. cache) [KByte]	Radar accelerator/ radar interface ¹⁾	CAN/CAN FD nodes	Ethernet 100/1000 Mbit	External bus interface ²⁾	Communication interfaces	HSM	Temperature ranges	Packages	Additional features/ remarks ³⁾
AURIX™ TC3xx family													
TC399XX	6/4	300	16000	6912	no	12	1	EBU, eMMC, 2x HSSL	6x SPI, 2x FlexRay, 12x LIN, 25x SENT, 4x PSi5, 2x I ² C, 4x MSC	EVITA full	K, L	LFBGA-516	5 V/3.3 V EVR, 8-bit SCR
TC399XP	6/4	300	16000	2816	no	12	1	EBU, eMMC, 2x HSSL	6x SPI, 2x FlexRay, 12x LIN, 25x SENT, 4x PSi5, 2x I ² C, 4x MSC	EVITA full	K, L	LFBGA-516	5 V/3.3 V EVR, 8-bit SCR
TC397XX	6/4	300	16000	6912	no	12	1	eMMC, 2x HSSL	6x SPI, 2x FlexRay, 12x LIN, 25x SENT, 4x PSi5, 2x I ² C, 4x MSC	EVITA full	K, L	LFBGA-292	5 V/3.3 V EVR, 8-bit SCR
TC397XP	6/4	300	16000	2816	no	12	1	eMMC, 2x HSSL	6x SPI, 2x FlexRay, 12x LIN, 25x SENT, 4x PSi5, 2x I ² C, 4x MSC	EVITA full	K, L	LFBGA-292	5 V/3.3 V EVR, 8-bit SCR
TC397XA	6/4	300	16000	6912	2x SPU/ 8x 400 Mbit/s LVDS	12	1	2x HSSL	6x SPI, 2x FlexRay, 12x LIN, 25x SENT, 4x PSi5, 2x I ² C, 4x MSC	EVITA full	K, L	LFBGA-292	5 V/3.3 V EVR, 8-bit SCR
TC3E7QX	4/2	300	12000	1824	no	20	1	HSSL	5x SPI, 2x FlexRay, 24x LIN, 25x SENT, 4x PSi5, 2x I ² C, 3x MSC	EVITA full	K, L	BGA-291	5 V/3.3 V EVR, 8-bit SCR
TC389QP	4/2	300	10000	1568	no	12	1	HSSL	5x SPI, 2x FlexRay, 24x LIN, 25x SENT, 4x PSi5, 2x I ² C, 3x MSC	EVITA full	K, L	LFBGA-516	5 V/3.3 V EVR, 8-bit SCR
TC387QP	4/2	300	10000	1568	no	12	1	HSSL	5x SPI, 2x FlexRay, 24x LIN, 25x SENT, 4x PSi5, 2x I ² C, 3x MSC	EVITA full	K, L	LFBGA-292	5 V/3.3 V EVR, 8-bit SCR
TC377TX	3/3	300	6000	4208	no	12	2	eMMC, HSSL	5x SPI, 1x FlexRay, 12x LIN, 15x SENT, 2x PSi5, 1x I ² C, 2x MSC	EVITA full	K, L	LFBGA-292	5 V/3.3 V EVR, 8-bit SCR
TC377TP	3/2	300	6000	1136	no	8	1	HSSL	5x SPI, 1x FlexRay, 12x LIN, 15x SENT, 2x PSi5, 1x I ² C, 2x MSC	EVITA full	K, L	LFBGA-292	5 V/3.3 V EVR, 8-bit SCR
TC375TP	3/2	300	6000	1136	no	8	1	HSSL	5x SPI, 1x FlexRay, 12x LIN, 15x SENT, 2x PSi5, 1x I ² C, 2x MSC	EVITA full	K, L	LQFP-176	5 V/3.3 V EVR, 8-bit SCR
TC367DP	2/2	300	4000	672	no	8	1	HSSL	4x SPI, 1x FlexRay, 12x LIN, 10x SENT, 2x PSi5, 1x I ² C, 1x MSC	EVITA full	K, L	LFBGA-292	5 V/3.3 V EVR, 8-bit SCR
TC366DP	2/2	300	4000	672	no	8	1	HSSL	4x SPI, 1x FlexRay, 12x LIN, 10x SENT, 2x PSi5, 1x I ² C, 1x MSC	EVITA full	K, L	BGA-180	5 V/3.3 V EVR, 8-bit SCR
TC365DP	2/2	300	4000	672	no	8	1	HSSL	4x SPI, 1x FlexRay, 12x LIN, 10x SENT, 2x PSi5, 1x I ² C, 1x MSC	EVITA full	K, L	LQFP-176	5 V/3.3 V EVR, 8-bit SCR
TC364DP	2/2	300	4000	672	no	8	1	HSSL	4x SPI, 1x FlexRay, 12x LIN, 10x SENT, 2x PSi5, 1x I ² C, 1x MSC	EVITA full	K, L	TQFP-144	5 V/3.3 V EVR, 8-bit SCR
TC364DP	2/2	300	4000	672	no	8	1	HSSL	4x SPI, 1x FlexRay, 12x LIN, 10x SENT, 2x PSi5, 1x I ² C, 1x MSC	EVITA full	K, L	LQFP-144	5 V/3.3 V EVR, 8-bit SCR
TC3A7QA	4/2	300	4000	7456	2x SPU/ 8x 600 Mbit/s LVDS	8	1	no	4x SPI, 1x FlexRay, 4x LIN	EVITA full	K, L	BGA-292	5 V/3.3 V EVR, 8-bit SCR
TC3A8QA	4/2	300	4000	7456	2x SPU/ 8x 600 Mbit/s LVDS	8	1	no	4x SPI, 1x FlexRay, 4x LIN	EVITA full	K, L	BGA-233	5 V/3.3 V EVR, 8-bit SCR
TC357TA	3/2	300	4000	3664	2x SPU/ 8x 400 Mbit/s LVDS	8	1	no	4x SPI, 1x FlexRay, 4x LIN	EVITA full	K, L	LFBGA-292	5 V/3.3 V EVR, 8-bit SCR
TC356TA	3/2	300	4000	3664	2x SPU/ 8x 400 Mbit/s LVDS	8	1	no	4x SPI, 1x FlexRay, 4x LIN	EVITA full	K, L	BGA-180	5 V/3.3 V EVR, 8-bit SCR
TC337DA	2/1	300	2000	1568	1x SPU/ 4x 400 Mbit/s LVDS	8	1	eMMC	4x SPI, 1x FlexRay, 12x LIN, 6x SENT	EVITA full	K, L	LFBGA-292	5 V/3.3 V EVR, 8-bit SCR
TC336DA	2/1	300	2000	1568	1x SPU/ 4x 400 Mbit/s LVDS	8	1	eMMC	4x SPI, 1x FlexRay, 12x LIN, 6x SENT	EVITA full	K, L	BGA-180	5 V/3.3 V EVR, 8-bit SCR
TC337LP	1/1	300	2000	248	no	8	no	no	4x SPI, 1x FlexRay, 12x LIN, 6x SENT	EVITA full	K, L	LFBGA-292	5 V/3.3 V EVR, 8-bit SCR
TC336LP	1/1	300	2000	248	no	8	no	no	4x SPI, 1x FlexRay, 12x LIN, 6x SENT	EVITA full	K, L	BGA-180	5 V/3.3 V EVR, 8-bit SCR
TC334LP	1/1	300	2000	248	no	8	no	no	4x SPI, 1x FlexRay, 12x LIN, 6x SENT	EVITA full	K, L	TQFP-144	5 V/3.3 V EVR, 8-bit SCR
TC333LP	1/1	300	2000	248	no	8	no	no	4x SPI, 1x FlexRay, 12x LIN, 6x SENT	EVITA full	K, L	TQFP-100	5 V/3.3 V EVR, 8-bit SCR
TC332LP	1/1	300	2000	248	no	8	no	no	4x SPI, 1x FlexRay, 12x LIN, 6x SENT	EVITA full	K, L	TQFP-80	5 V/3.3 V EVR, 8-bit SCR
TC327LP	1/1	160	1000	96	no	8	no	no	4x SPI, 6x SENT, 6x LIN	EVITA full	K, L	LFBGA-292	5 V/3.3 V EVR, 8-bit SCR
TC324LP	1/1	160	1000	96	no	8	no	no	4x SPI, 6x SENT, 6x LIN	EVITA full	K, L	TQFP-144	5 V/3.3 V EVR, 8-bit SCR
TC323LP	1/1	160	1000	96	no	8	no	no	4x SPI, 6x SENT, 6x LIN	EVITA full	K, L	TQFP-100	5 V/3.3 V EVR, 8-bit SCR
TC322LP	1/1	160	1000	96	no	8	no	no	4x SPI, 6x SENT, 6x LIN	EVITA full	K, L	TQFP-80	5 V/3.3 V EVR, 8-bit SCR

1) SPU = Signal Processing Unit

2) HSSL = High-Speed Serial Link

3) 8-bit SCR = Standby Controller for Low Power Modes, EVR = Embedded Voltage Regulator

Where to buy

Infiniteon distribution partners and sales offices:

www.infineon.com/WhereToBuy

Service hotline

Infiniteon offers its toll-free 0800/4001 service hotline as one central number, available 24/7 in English, Mandarin and German.

- > Germany 0800 951 951 951 (German/English)
- > China, mainland 4001 200 951 (Mandarin/English)
- > India 000 800 4402 951 (English)
- > USA 1-866 951 9519 (English/German)
- > Other countries 00* 800 951 951 951 (English/German)
- > Direct access +49 89 234-0 (interconnection fee, German/English)

* Please note: Some countries may require you to dial a code other than "00" to access this international number.
Please visit www.infineon.com/service for your country!



Mobile product catalog

Mobile app for iOS and Android.

www.infineon.com

Published by
Infineon Technologies AG
81726 Munich, Germany

© 2020 Infineon Technologies AG.
All rights reserved.

Please note!

This Document is for information purposes only and any information given herein shall in no event be regarded as a warranty, guarantee or description of any functionality, conditions and/or quality of our products or any suitability for a particular purpose. With regard to the technical specifications of our products, we kindly ask you to refer to the relevant product data sheets provided by us. Our customers and their technical departments are required to evaluate the suitability of our products for the intended application.

We reserve the right to change this document and/or the information given herein at any time.

Additional information

For further information on technologies, our products, the application of our products, delivery terms and conditions and/or prices, please contact your nearest Infineon Technologies office (www.infineon.com).

Warnings

Due to technical requirements, our products may contain dangerous substances. For information on the types in question, please contact your nearest Infineon Technologies office.

Except as otherwise explicitly approved by us in a written document signed by authorized representatives of Infineon Technologies, our products may not be used in any life-endangering applications, including but not limited to medical, nuclear, military, life-critical or any other applications where a failure of the product or any consequences of the use thereof can result in personal injury.