

## BARBARA-XW-PF

White version with ~75° wide beam

### TECHNICAL SPECIFICATIONS:

Dimensions	Ø 70.0 mm
Height	41.7 mm
Fastening	socket
ROHS compliant	yes ⓘ

### MATERIAL SPECIFICATIONS:

Component	Type	Material	Colour	Finish	Coating
BARBARA-XW-PF	Reflector	HRPC	white		

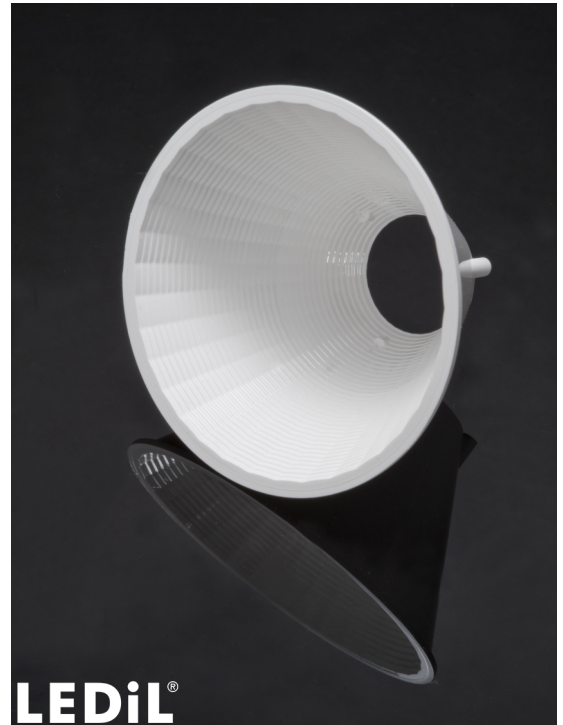



### ORDERING INFORMATION:

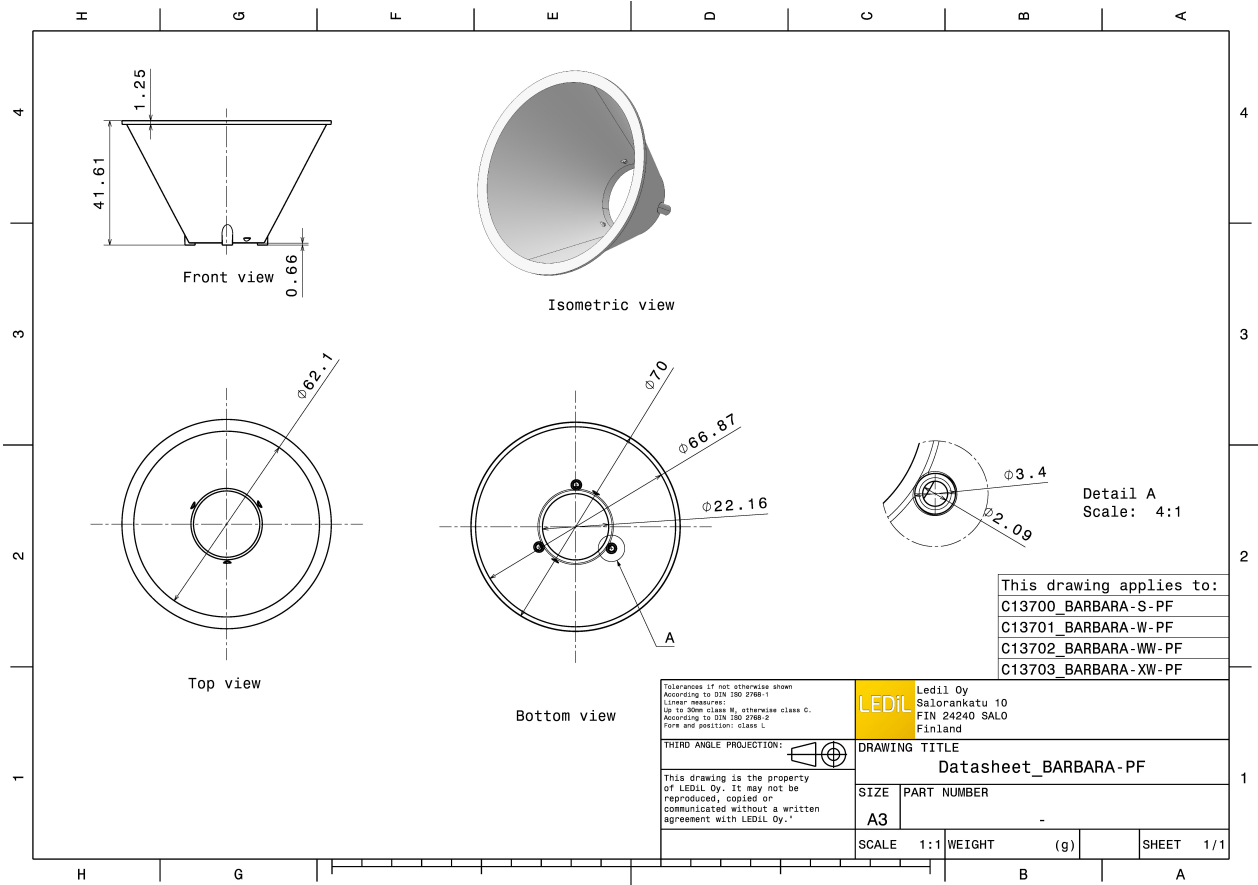

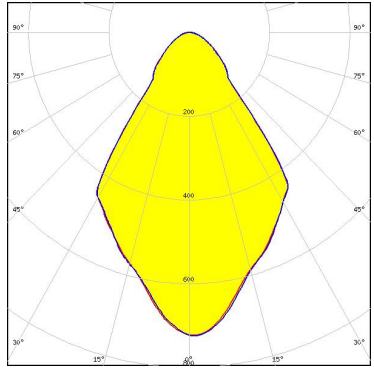
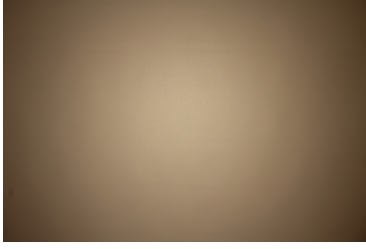

Component	Qty in box	MOQ	MPQ	Box weight (kg)
F13703_BARBARA-XW-PF » Box size: 480 x 280 x 300 mm	288	90	18	8.4

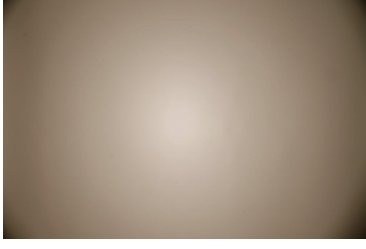
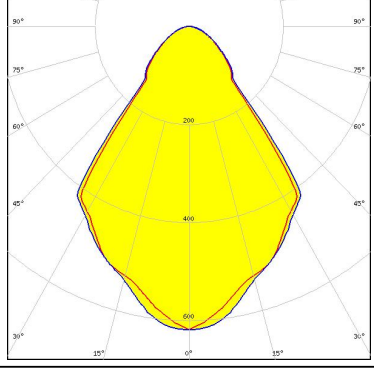
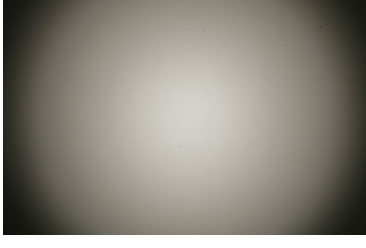
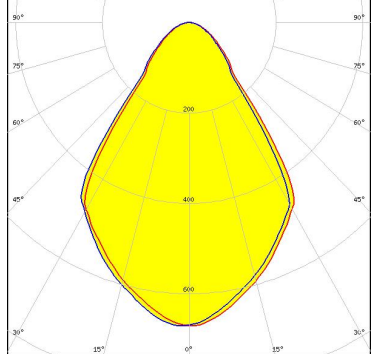

#### PHOTOMETRIC DATA (MEASURED):

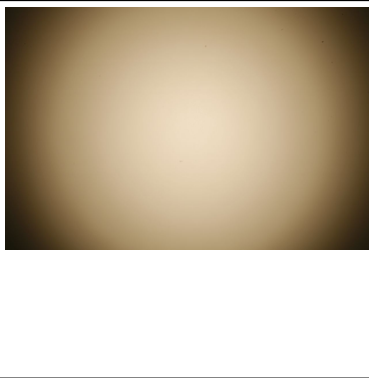
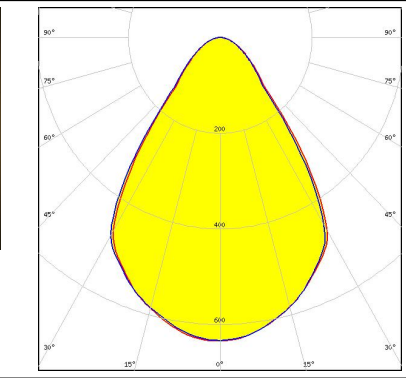
<p>bridgelux.</p> <p>LED V10 Gen7            FWHM 70.0°            Efficiency 90 %            Peak intensity 0.7 cd/lm            LEDs/each optic 1            Light colour White</p> <p>Required components:            C13709_PF-SOCKET-VERO13-18            Bender Wirth: 434 Typ L1</p>		
<p>bridgelux.</p> <p>LED V15 Gen6            FWHM 71.0°            Efficiency 89 %            Peak intensity 0.7 cd/lm            LEDs/each optic 1            Light colour White</p> <p>Required components:            C13709_PF-SOCKET-VERO13-18            Bender Wirth: 456 Typ L2</p>		
<p>bridgelux.</p> <p>LED V8 Gen6            FWHM 74.0°            Efficiency 90 %            Peak intensity 0.6 cd/lm            LEDs/each optic 1            Light colour White</p> <p>Required components:            C13761_PF-SOCKET-CXA15</p>		
<p>bridgelux.</p> <p>LED VERO13            FWHM 72.0°            Efficiency 93 %            Peak intensity 0.7 cd/lm            LEDs/each optic 1            Light colour White</p> <p>Required components:            C13709_PF-SOCKET-VERO13-18</p>		

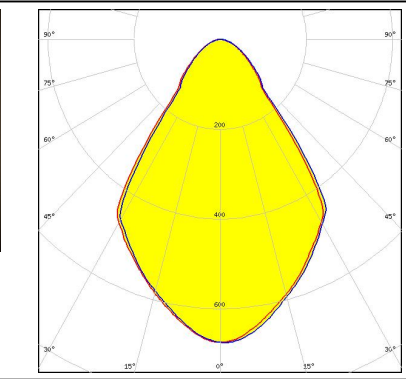
#### PHOTOMETRIC DATA (MEASURED):

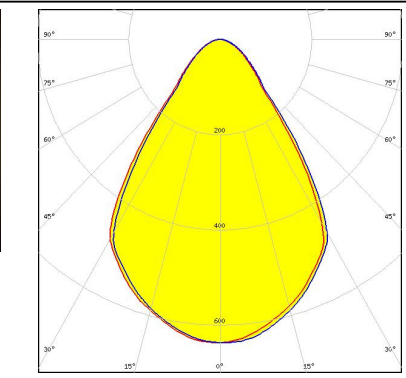
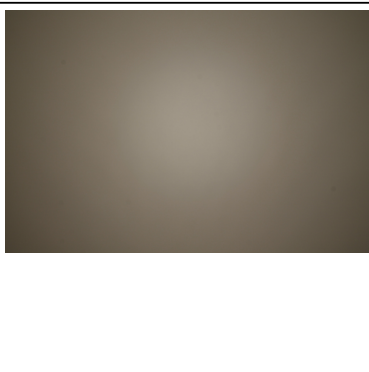
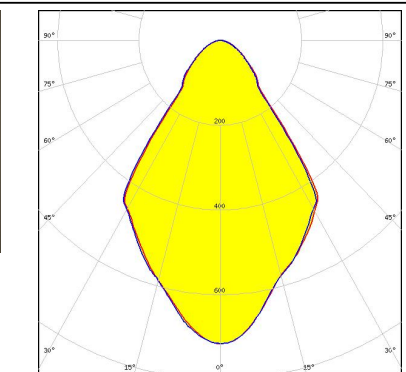
<p>bridgelux.</p> <p>LED VERO18 FWHM 72.0° Efficiency 93 % Peak intensity 0.6 cd/lm LEDs/each optic 1 Light colour White Required components: C13709_PF-SOCKET-VERO13-18</p>		
<p>bridgelux.</p> <p>LED Xenio Point 13mm FWHM 71.0° Efficiency 92 % Peak intensity 0.7 cd/lm LEDs/each optic 1 Light colour White Required components: C13709_PF-SOCKET-VERO13-18</p>		
<p>bridgelux.</p> <p>LED Xenio Point 18mm FWHM 72.0° Efficiency 91 % Peak intensity 0.6 cd/lm LEDs/each optic 1 Light colour White Required components: C13709_PF-SOCKET-VERO13-18</p>		
<p><b>CITIZEN</b></p> <p>LED CLL02x/CLU02x (LES10) FWHM 70.0° Efficiency 90 % Peak intensity 0.7 cd/lm LEDs/each optic 1 Light colour White Required components: C13709_PF-SOCKET-VERO13-18 Bender Wirth: 434 Typ L1</p>		

#### PHOTOMETRIC DATA (MEASURED):

#### CITIZEN

LED CLU700/701/702  
 FWHM 70.0°  
 Efficiency 90 %  
 Peak intensity 0.8 cd/lm  
 LEDs/each optic 1  
 Light colour White  
 Required components:  
 C13709\_PF-SOCKET-VERO13-18  
 Bender Wirth: 434 Typ L1

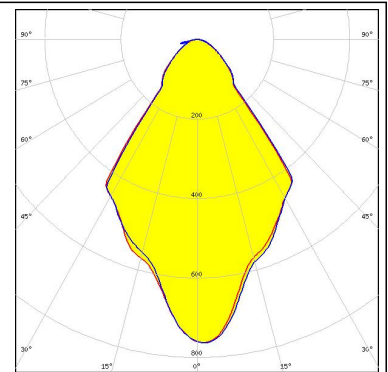
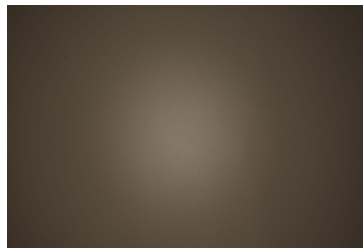

#### CREE

LED CXA/B 15xx  
 FWHM 70.0°  
 Efficiency 90 %  
 Peak intensity 0.7 cd/lm  
 LEDs/each optic 1  
 Light colour White  
 Required components:  
 C13709\_PF-SOCKET-VERO13-18  
 Bender Wirth: 441 Typ L1

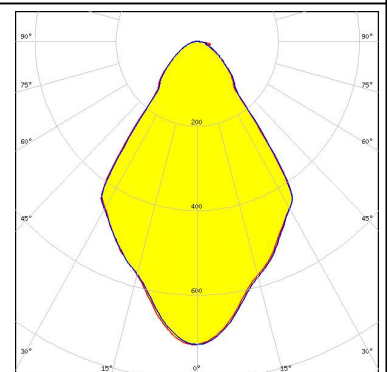
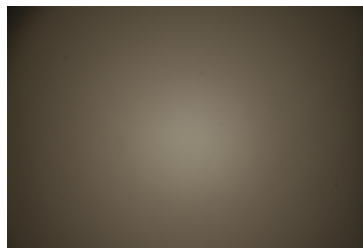

#### CREE

LED CXA/B 15xx  
 FWHM 73.0°  
 Efficiency 85 %  
 Peak intensity 0.6 cd/lm  
 LEDs/each optic 1  
 Light colour White  
 Required components:  
 C13083\_PF-SOCKET  
 C14658\_BARBARA-RZ-LENS

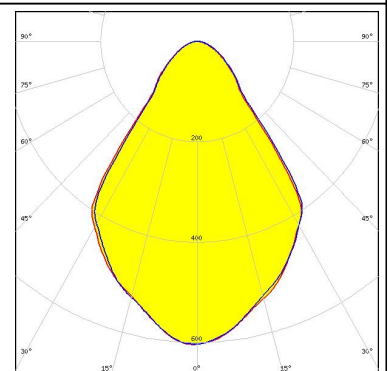
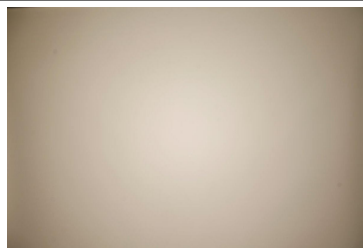

#### CREE

LED CXA/B 15xx  
 FWHM 70.0°  
 Efficiency 92 %  
 Peak intensity 0.8 cd/lm  
 LEDs/each optic 1  
 Light colour White  
 Required components:  
 C14115\_PF-SOCKET-CXA15-18



#### PHOTOMETRIC DATA (MEASURED):



LED CXA/B 1816 & CXA/B 1820 & CXA 1850  
 FWHM 70.0°  
 Efficiency 93 %  
 Peak intensity 0.7 cd/lm  
 LEDs/each optic 1  
 Light colour White  
 Required components:  
 C14115\_PF-SOCKET-CXA15-18

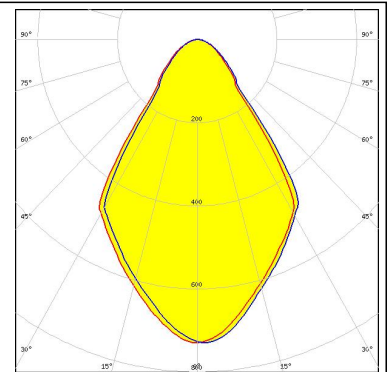

LED CXA/B 1816 & CXA/B 1820 & CXA 1850  
 FWHM 67.0°  
 Efficiency 82 %  
 Peak intensity 0.7 cd/lm  
 LEDs/each optic 1  
 Light colour White  
 Required components:  
 C13709\_PF-SOCKET-VERO13-18  
 Bender Wirth: 437 Typ L1

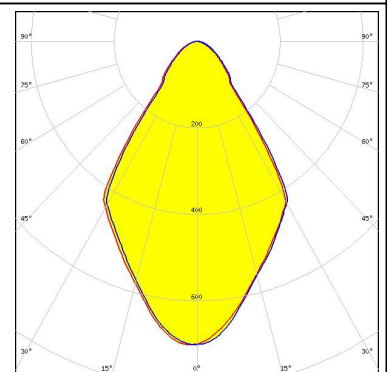
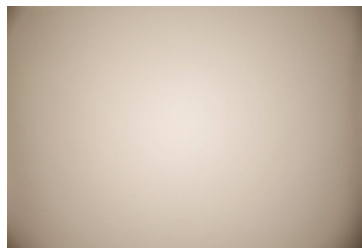

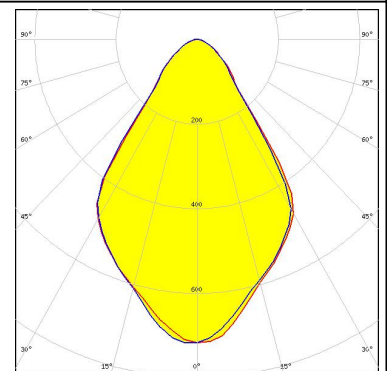
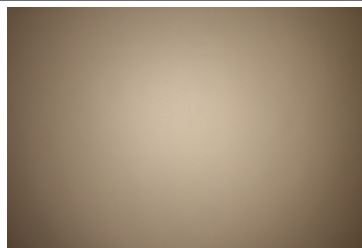

LED LUXEON CoB 1202/1203  
 FWHM 71.0°  
 Efficiency 92 %  
 Peak intensity 0.7 cd/lm  
 LEDs/each optic 1  
 Light colour White  
 Required components:  
 C14037\_PF-NSX-SOCKET



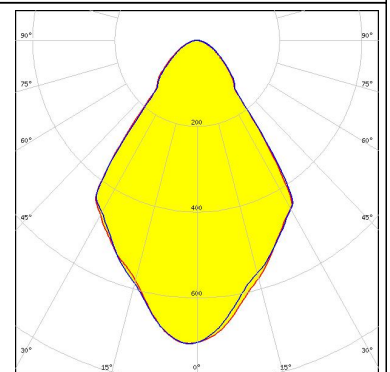
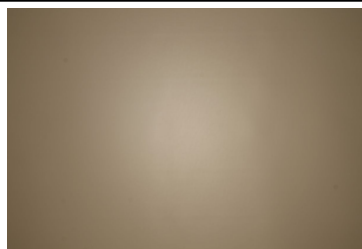

LED LUXEON CoB 1202/1203  
 FWHM 71.0°  
 Efficiency 90 %  
 Peak intensity 0.7 cd/lm  
 LEDs/each optic 1  
 Light colour White  
 Required components:  
 C13709\_PF-SOCKET-VERO13-18  
 Bender Wirth: 438 Typ L1

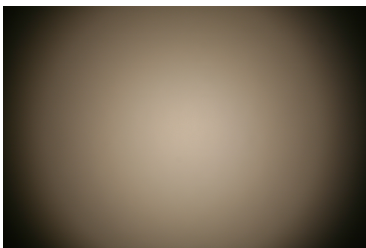
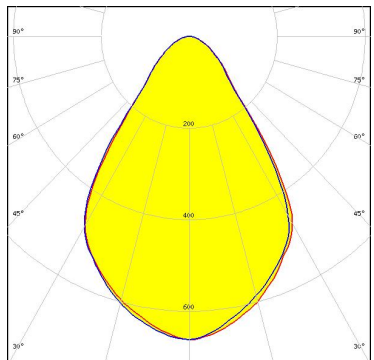

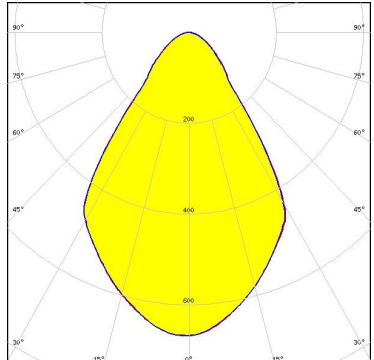
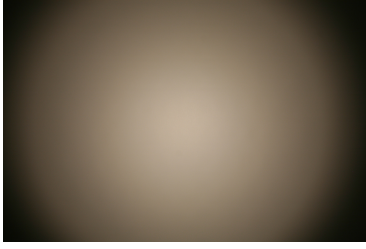
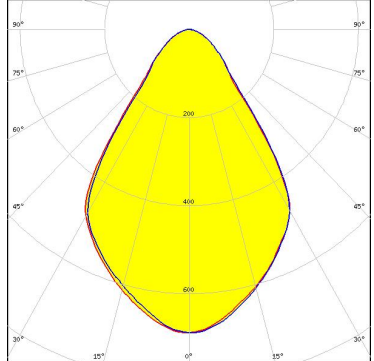
#### PHOTOMETRIC DATA (MEASURED):

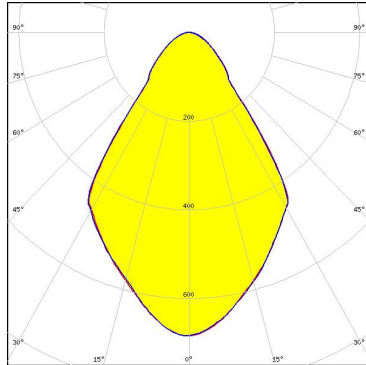
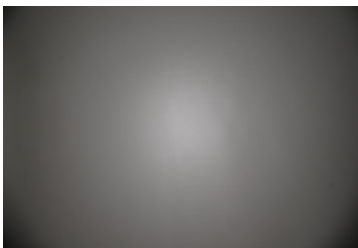
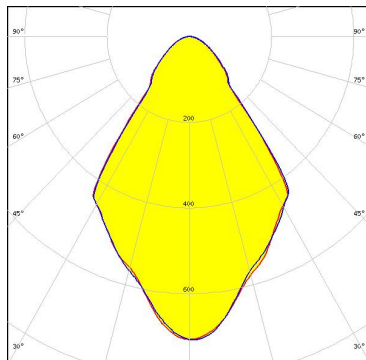

<p><b>LUMILEDS</b></p> <p>LED LUXEON CoB 1202s            FWHM 75.0°            Efficiency 92 %            Peak intensity 0.7 cd/lm            LEDs/each optic 1            Light colour White            Required components:            C13761_PF-SOCKET-CXA15</p>		
<p><b>NICHIA</b></p> <p>LED COB J-Type            FWHM 72.0°            Efficiency 93 %            Peak intensity 0.7 cd/lm            LEDs/each optic 1            Light colour White            Required components:            C14037_PF-NSX-SOCKET</p>		
<p><b>NICHIA</b></p> <p>LED COB J-Type            FWHM 70.0°            Efficiency 89 %            Peak intensity 0.7 cd/lm            LEDs/each optic 1            Light colour White            Required components:            C13709_PF-SOCKET-VERO13-18            Bender Wirth: 463 Typ L2</p>		
<p><b>NICHIA</b></p> <p>LED COB L-Type (LES 11)            FWHM 72.0°            Efficiency 93 %            Peak intensity 0.7 cd/lm            LEDs/each optic 1            Light colour White            Required components:            C14037_PF-NSX-SOCKET</p>		

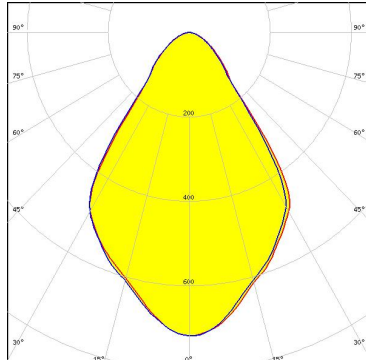
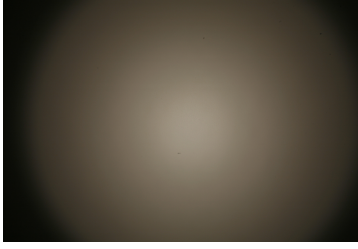
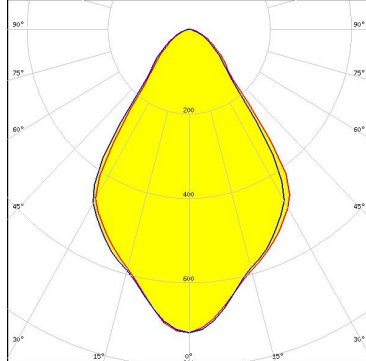
#### PHOTOMETRIC DATA (MEASURED):

<p><b>NICHIA</b></p> <p>LED COB L-Type (LES 11)            FWHM 70.0°            Efficiency 90 %            Peak intensity 0.7 cd/lm            LEDs/each optic 1            Light colour White            Required components:            C13709_PF-SOCKET-VERO13-18            Bender Wirth: 438 Typ L1</p>		
<p><b>NICHIA</b></p> <p>LED COB L-Type (LES 9)            FWHM 70.0°            Efficiency 90 %            Peak intensity 0.7 cd/lm            LEDs/each optic 1            Light colour White            Required components:            C13709_PF-SOCKET-VERO13-18            Bender Wirth: 438 Typ L1</p>		
<p><b>NICHIA</b></p> <p>LED COB L-Type (LES 9)            FWHM 72.0°            Efficiency 93 %            Peak intensity 0.7 cd/lm            LEDs/each optic 1            Light colour White            Required components:            C14037_PF-NSX-SOCKET</p>		
<p><b>NICHIA</b></p> <p>LED NSCxL036A            FWHM 71.0°            Efficiency 91 %            Peak intensity 0.7 cd/lm            LEDs/each optic 1            Light colour White            Required components:            C14037_PF-NSX-SOCKET</p>		

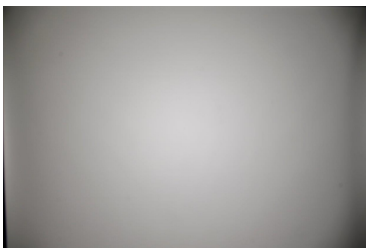
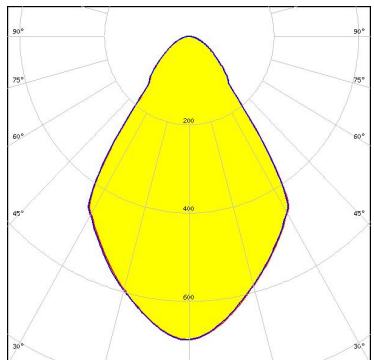

#### PHOTOMETRIC DATA (MEASURED):

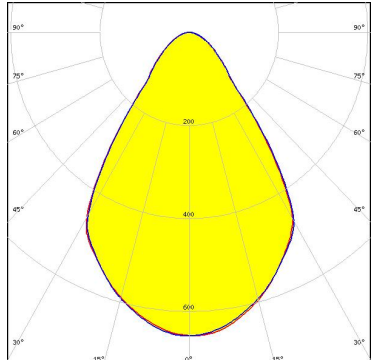
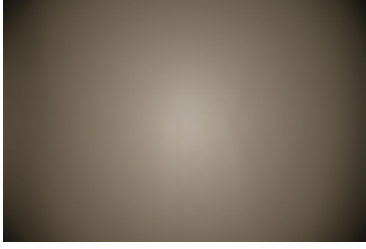
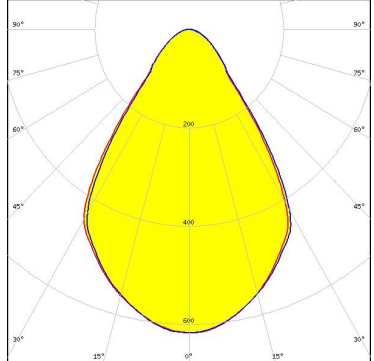
<p><b>OSRAM</b> Opto Semiconductors</p> <p>LED            OSTAR Stage (S2WP)</p> <p>FWHM        74.0°</p> <p>Efficiency    83 %</p> <p>Peak intensity 0.6 cd/lm</p> <p>LEDs/each optic 1</p> <p>Light colour    White</p> <p>Required components:</p> <p>  C13083_PF-SOCKET</p> <p>  C14658_BARBARA-RZ-LENS</p>		
<p><b>OSRAM</b> Opto Semiconductors</p> <p>LED            Soleriq S13</p> <p>FWHM        70.0°</p> <p>Efficiency    90 %</p> <p>Peak intensity 0.7 cd/lm</p> <p>LEDs/each optic 1</p> <p>Light colour    White</p> <p>Required components:</p> <p>  C13709_PF-SOCKET-VERO13-18</p> <p>  Bender Wirth: 437 Typ L1</p>		
<p><b>SAMSUNG</b></p> <p>LED            LC026B / 033B / 040B</p> <p>FWHM        70.0°</p> <p>Efficiency    90 %</p> <p>Peak intensity 0.6 cd/lm</p> <p>LEDs/each optic 1</p> <p>Light colour    White</p> <p>Required components:</p> <p>  C13709_PF-SOCKET-VERO13-18</p> <p>  Bender Wirth: 450 Typ L2</p>		
<p><b>XICATO</b></p> <p>LED            XTM - 19mm LES</p> <p>FWHM        70.0°</p> <p>Efficiency    83 %</p> <p>Peak intensity 0.6 cd/lm</p> <p>LEDs/each optic 1</p> <p>Light colour    White</p> <p>Required components:</p> <p>  C14636_XTM-PF-ADAPTER</p>		

## PHOTOMETRIC DATA (MEASURED):

### XICATO

LED XTM - 9mm LES  
FWHM 70.0°  
Efficiency 86 %  
Peak intensity 0.7 cd/lm  
LEDs/each optic 1  
Light colour White  
Required components:  
C14636\_XTM-PF-ADAPTER

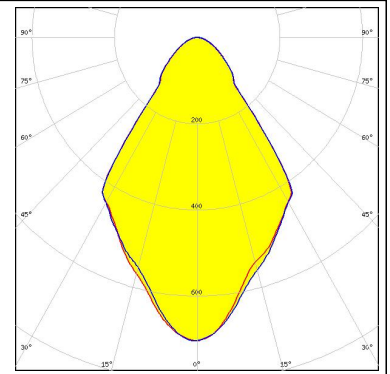
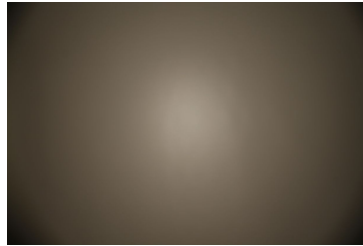

#### PHOTOMETRIC DATA (SIMULATED):



LED V10 Gen7  
FWHM 66.0°  
Efficiency 88 %  
Peak intensity 0.9 cd/lm  
LEDs/each optic 1  
Light colour White  
Required components:  
C13709\_PF-SOCKET-VERO13-18  
Bender Wirth: 486 Typ L1

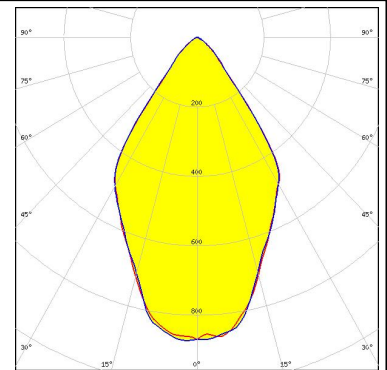

LED LUXEON CoB Compact  
FWHM 75.0°  
Efficiency 92 %  
Peak intensity 0.7 cd/lm  
LEDs/each optic 1  
Light colour White  
Required components:  
C13761\_PF-SOCKET-CXA15



LED CxM-14 (19x19)  
FWHM 70.0°  
Efficiency 90 %  
Peak intensity 0.7 cd/lm  
LEDs/each optic 1  
Light colour White  
Required components:  
C13709\_PF-SOCKET-VERO13-18  
Bender Wirth: 433 Typ L1



LED CxM-9 (13.5x13.5)  
FWHM 70.0°  
Efficiency 90 %  
Peak intensity 0.7 cd/lm  
LEDs/each optic 1  
Light colour White  
Required components:  
C13709\_PF-SOCKET-VERO13-18  
Bender Wirth: 434 Typ L1

#### PHOTOMETRIC DATA (SIMULATED):

#### OSRAM

Opto Semiconductors

LED Soleriq S15  
FWHM 74.0°  
Efficiency 95 %  
Peak intensity 0.7 cd/lm  
LEDs/each optic 1  
Light colour White

Required components:  
C13709\_PF-SOCKET-VERO13-18  
Bender Wirth: 433 Typ L1

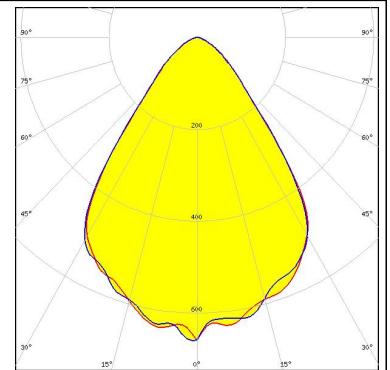

#### SAMSUNG

LED LC010C  
FWHM 66.0°  
Efficiency 89 %  
Peak intensity 0.9 cd/lm  
LEDs/each optic 1  
Light colour White

Required components:  
C13709\_PF-SOCKET-VERO13-18  
Bender Wirth: 479 Typ L1

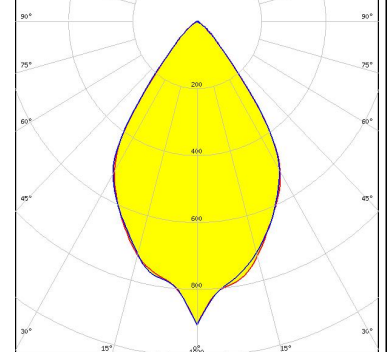

#### SAMSUNG

LED LC020C  
FWHM 70.0°  
Efficiency 88 %  
Peak intensity 0.8 cd/lm  
LEDs/each optic 1  
Light colour White

Required components:  
C13709\_PF-SOCKET-VERO13-18  
Bender Wirth: 479 Typ L1

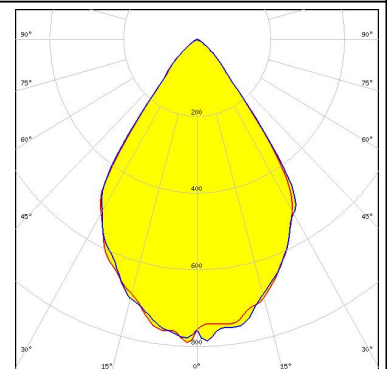

#### SAMSUNG

LED LC040C  
FWHM 70.0°  
Efficiency 84 %  
Peak intensity 0.7 cd/lm  
LEDs/each optic 1  
Light colour White

Required components:  
C13709\_PF-SOCKET-VERO13-18  
Bender Wirth: 480 Typ L1

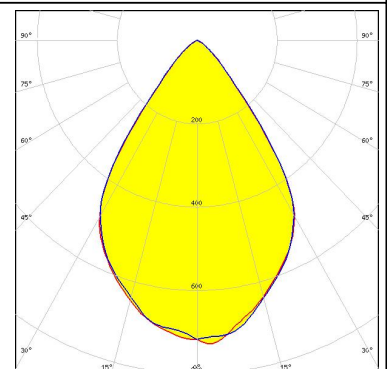

## PHOTOMETRIC DATA (SIMULATED):

	
SEOUL SEMICONDUCTOR	
LED	ZC12/18
FWHM	70.0°
Efficiency	90 %
Peak intensity	0.7 cd/lm
LEDs/each optic	1
Light colour	White
Required components:	
C13709_PF-SOCKET-VERO13-18	
Bender Wirth: 433 Typ L1	
<hr/>	
	
SEOUL SEMICONDUCTOR	
LED	ZC4/6
FWHM	70.0°
Efficiency	90 %
Peak intensity	0.7 cd/lm
LEDs/each optic	1
Light colour	White
Required components:	
C13709_PF-SOCKET-VERO13-18	
Bender Wirth: 434 Typ L1	

#### GENERAL INFORMATION:

NOTE: The typical beam angle will be changed by different color, chip size and chip position tolerance. The typical total beam angle is the full angle measured where the luminous intensity is half of the peak value.

Due to use of high power COB's with this product, special attention to proper thermal design is highly recommended. LEDiL has no liability for direct, indirect or consecutive damages arising from the LEDiL products being used outside of the recommended temperature range.

#### MATERIALS:

As part of our continuous research and improvement processes, and to ensure the best possible quality and availability of our products, LEDiL reserves the right to change material grades without notice.

#### PRODUCT DATA USER AGREEMENT AND DISCLAIMER:

The measured data in the provided downloadable LEDiL Product Datasheets and Mechanical 2D-Drawings is rounded and provided as reference for planning. LEDiL Oy's optical specifications have been verified by conducting performance testing of the products in accordance with the company's quality system. The reported data are averaged results of multiple measurements with typical variation. LEDiL Oy reserves the right to without prior notification make changes and improvements to its products.

LEDiL Oy assumes neither warranty, nor guarantee nor any other liability of any kind for the contents and correctness of the provided data. The provided data has been generated with highest diligence but the provided data may in reality not represent the complete possible variation range of all intrinsic parameters. Therefore, in certain cases a deviation from the provided data could occur.

LEDiL Oy reserves the right to undertake technical changes of its products without further notification which could lead to changes in the provided data. LEDiL Oy assumes no liability of any kind for the possible deviation from any provided data or any other damage resulting from the usage of the provided data.

The user agrees to this disclaimer and user agreement with the download or usage of the provided files.

#### LEDiL Oy

Joensuunkatu 13  
FI-24240 SALO  
Finland

#### LEDiL Inc.

228 West Page Street  
Suite D  
Sycamore IL 60178  
USA

#### Local sales and technical support

[www.ledil.com/where\\_to\\_buy](http://www.ledil.com/where_to_buy)

#### Shipping locations

Salo, Finland  
Hong Kong, China

#### Distribution Partners

[www.ledil.com/where\\_to\\_buy](http://www.ledil.com/where_to_buy)