Table 1. Main characteristics

| Symbol | Value | Unit |
|--------------------|------------|------|
| $I_{T(rms)}$ | 4 | A |
| V_{DRM}, V_{RRM} | 600 to 800 | V |
| I_{GT} | 5 to 35 | mA |

Table 2. Device summary

| Symbol ⁽¹⁾ | Marking |
|-----------------------|------------------------------|
| T405-xxxB | see Table 11 |
| T405-xxxB-TR | |
| T405-xxxH | |
| T405-xxxT | |
| T410-xxxB | |
| T410-xxxB-TR | |
| T410-xxxH | |
| T410-xxxT | |
| T435-xxxB | |
| T435-xxxB-TR | |
| T435-xxxH | |
| T435-xxxT | |

1. xxx = Voltage: 600 V, 700 V or 800 V (see [Table 10](#)).

Features

- Three quadrants Triac
- 600 to 800 V V_{DRM}/V_{RRM}

Applications

- General purpose AC inductive loads
- Motor control circuits
- Small home appliances

Description

Based on ST's Snubberless / logic level technology providing high commutation performances, the T4 series is suitable for use on AC inductive loads. They are recommended for applications using universal motors, electro valves, kitchen aid equipments, power tools, and dishwashers.

1 Characteristics

Table 3. Absolute maximum ratings ($T_j = 25\text{ °C}$ unless otherwise stated)

| Symbol | Parameter | | | Value | Unit |
|--------------|--|-------------------------|-----------------------|--------------|-------------|
| $I_{T(rms)}$ | On-state rms current (full sine wave) | IPAK, DPAK, TO-220AB | $T_c = 110\text{ °C}$ | 4 | A |
| I_{TSM} | Non repetitive surge peak on-state current (full cycle, T_j initial = 25 °C) | F = 50 Hz | t = 20 ms | 30 | A |
| | | F = 60 Hz | t = 16.7 ms | 31 | |
| I^2t | I^2t value for fusing | | $t_p = 10\text{ ms}$ | 5.1 | A^2s |
| dI/dt | Critical rate of rise of on-state current $I_G = 2 \times I_{GT}$, $t_r \leq 100\text{ ns}$ | F = 120 Hz | $T_j = 125\text{ °C}$ | 50 | A/ μs |
| I_{GM} | Peak gate current | $t_p = 20\text{ }\mu s$ | $T_j = 125\text{ °C}$ | 4 | A |
| $P_{G(AV)}$ | Average gate power dissipation | | $T_j = 125\text{ °C}$ | 1 | W |
| T_{stg} | Storage junction temperature range | | | - 40 to +150 | $^{\circ}C$ |
| T_j | Operating junction temperature range | | | - 40 to +125 | |

Table 4. Electrical characteristics ($T_j = 25\text{ °C}$, unless otherwise stated)

| Symbol | Test conditions | Quadrant | | Value | | | Unit |
|-------------------------------------|--|-----------------------|------|-------|------|------|------------|
| | | | | T405 | T410 | T435 | |
| $I_{GT}^{(1)}$ | $V_D = 12\text{ V}$, $R_L = 30\text{ }\Omega$ | I - II - III | Max. | 5 | 10 | 35 | mA |
| V_{GT} | $V_D = 12\text{ V}$, $R_L = 30\text{ }\Omega$ | I - II - III | Max. | 1.3 | | | V |
| V_{GD} | $V_D = V_{DRM}$, $R_L = 3.3\text{ k}\Omega$, $T_j = 125\text{ °C}$ | I - II - III | Min. | 0.2 | | | V |
| $I_H^{(2)}$ | $I_T = 100\text{ mA}$ | | Max. | 10 | 15 | 35 | mA |
| I_L | $I_G = 1.2 I_{GT}$ | I - III | Max. | 10 | 25 | 50 | mA |
| | | II | Max. | 15 | 30 | 60 | |
| dV/dt ⁽²⁾ | $V_D = 67\% V_{DRM}$, gate open | $T_j = 125\text{ °C}$ | Min. | 20 | 40 | 400 | V/ μs |
| (dI/dt) _c ⁽²⁾ | (dV/dt) _c = 0.1 V/ μs | $T_j = 125\text{ °C}$ | Min. | 1.8 | 2.7 | | A/ms |
| | (dV/dt) _c = 10 V/ μs | | | 0.9 | 2.0 | | |
| | (without snubber) | | | | | 2.5 | |

1. Minimum I_{GT} is guaranteed at 5% of I_{GT} max.
2. For both polarities of A2 referenced to A1

Table 5. Static characteristics

| Symbol | Test conditions | | | Value | Unit |
|------------------------|--|------------------------------------|------|-------|---------------|
| $V_{TM}^{(1)}$ | $I_{TM} = 5.5 \text{ A}$, $t_p = 380 \text{ }\mu\text{s}$ | $T_j = 25 \text{ }^\circ\text{C}$ | Max. | 1.56 | V |
| $V_{t0}^{(1)}$ | Threshold voltage | $T_j = 125 \text{ }^\circ\text{C}$ | Max. | 0.89 | V |
| $R_d^{(1)}$ | Dynamic resistance | $T_j = 125 \text{ }^\circ\text{C}$ | Max. | 120 | m Ω |
| I_{DRM} I_{RRM} | $V_{DRM} = V_{RRM}$ | $T_j = 25 \text{ }^\circ\text{C}$ | Max. | 5 | μA |
| | | $T_j = 125 \text{ }^\circ\text{C}$ | | 1 | mA |

1. For both polarities of A2 referenced to A1

Table 6. Thermal resistance

| Symbol | Parameter | | Value | Unit | |
|---------------|-----------------------|------------------------------|----------------------|------|--------------------|
| $R_{th(j-c)}$ | Junction to case (AC) | | IPAK, DPAK, TO-220AB | 2.6 | $^\circ\text{C/W}$ |
| $R_{th(j-a)}$ | Junction to ambient | $S^{(1)} = 0.5 \text{ cm}^2$ | DPAK | 70 | $^\circ\text{C/W}$ |
| | Junction to ambient | | TO-220AB | 60 | $^\circ\text{C/W}$ |
| | | | | IPAK | 100 |

1. S = Copper surface under tab.

Figure 1. Maximum power dissipation versus RMS on-state current (full cycle)

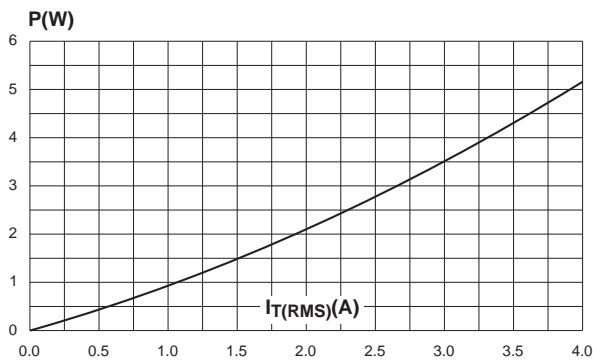

Figure 2. RMS on-state current versus case temperature (full cycle)

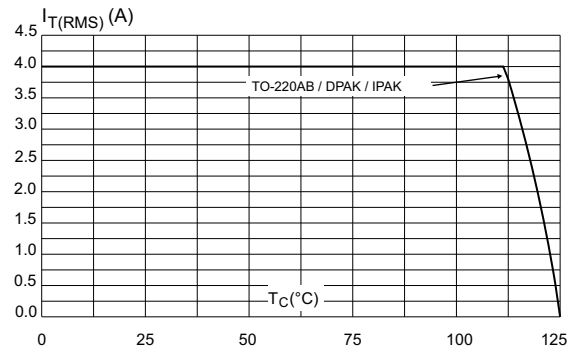

Figure 3. RMS on-state current versus ambient temperature (printed circuit board FR4, copper thickness: 35µm) (full cycle)



Figure 4. Relative variation of thermal impedance versus pulse duration

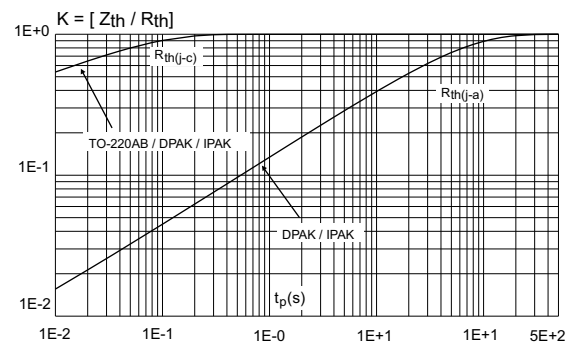

Figure 5. On-state characteristics (maximum values)

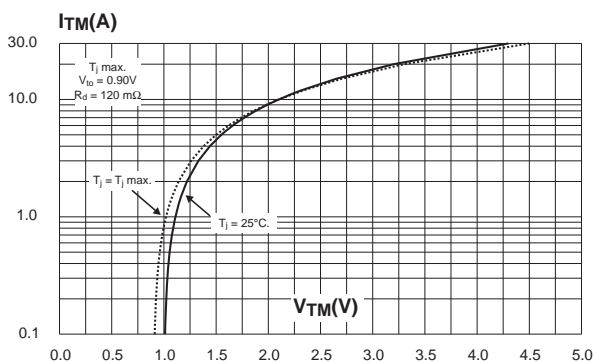

Figure 6. Surge peak on-state current versus number of cycles

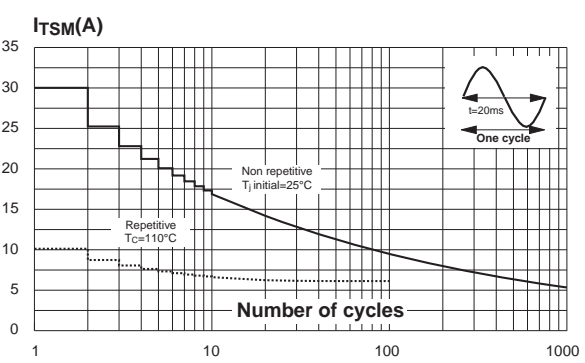

Figure 7. Non-repetitive surge peak on-state current for a sinusoidal pulse with width $t_p < 10$ ms



Figure 8. Relative variation of gate trigger current, holding current and latching current versus junction temperature (typical values)



Figure 9. Relative variation of critical rate of decrease of main current versus $(dV/dt)_c$ (typical values)



Figure 10. Relative variation of critical rate of decrease of main current versus junction temperature



Figure 11. DPAK thermal resistance junction to ambient versus copper surface under tab (printed circuit board FR4, copper thickness: 35 μ m)

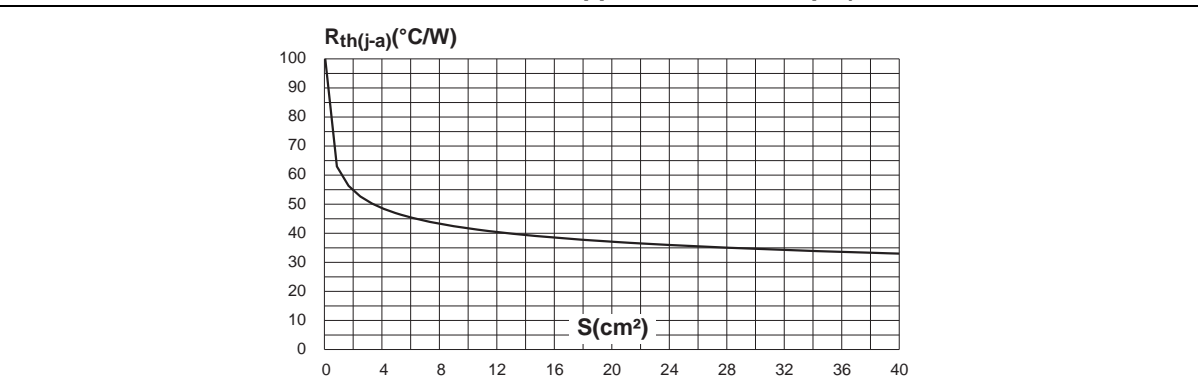

2 Package information

- Molding epoxy meets UL94, V0 and is halogen free
- Lead-free package
- Recommended torque: 0.4 to 0.6 N·m for TO-220AB

In order to meet environmental requirements, ST offers these devices in different grades of ECOPACK® packages, depending on their level of environmental compliance. ECOPACK® specifications, grade definitions and product status are available at: www.st.com. ECOPACK® is an ST trademark.

2.1 DPAK package information

Figure 12. DPAK package outline



Note: This package drawing may slightly differ from the physical package. However, all the specified dimensions are guaranteed.

Table 7. DPAK package mechanical data

| Ref. | Dimensions | | | | | |
|------|-------------|-------|-------|-----------------------|------|--------|
| | Millimeters | | | Inches ⁽¹⁾ | | |
| | Min. | Typ. | Max. | Min. | Typ. | Max. |
| A | 2.18 | | 2.40 | 0.086 | | 0.0944 |
| A1 | 0.9 | | 1.10 | 0.035 | | 0.0433 |
| A2 | 0.03 | | 0.23 | 0.0011 | | 0.0090 |
| b | 0.64 | | 0.90 | 0.0251 | | 0.0354 |
| b4 | 4.95 | | 5.46 | 0.1948 | | 0.2149 |
| c | 0.46 | | 0.61 | 0.0181 | | 0.0240 |
| c2 | 0.46 | | 0.60 | 0.0181 | | 0.0236 |
| D | 5.97 | | 6.22 | 0.2350 | | 0.2448 |
| D1 | 4.95 | | | 0.1948 | | |
| E | 6.35 | | 6.73 | 0.2500 | | 0.2649 |
| E1 | 4.32 | | | 0.1700 | | |
| e | | 2.286 | | | 0.09 | |
| e1 | | 4.572 | | | 0.18 | |
| H | 9.35 | | 10.40 | 0.3681 | | 0.4094 |
| L | 1.0 | | 1.78 | 0.039 | | 0.0700 |
| L2 | | | 1.27 | | | 0.0500 |
| L4 | 0.6 | | 1.02 | 0.023 | | 0.0401 |
| V2 | -8° | | +8° | -8° | | +8° |

1. Inch dimensions are only for reference

Figure 13. Footprint (dimensions in mm)

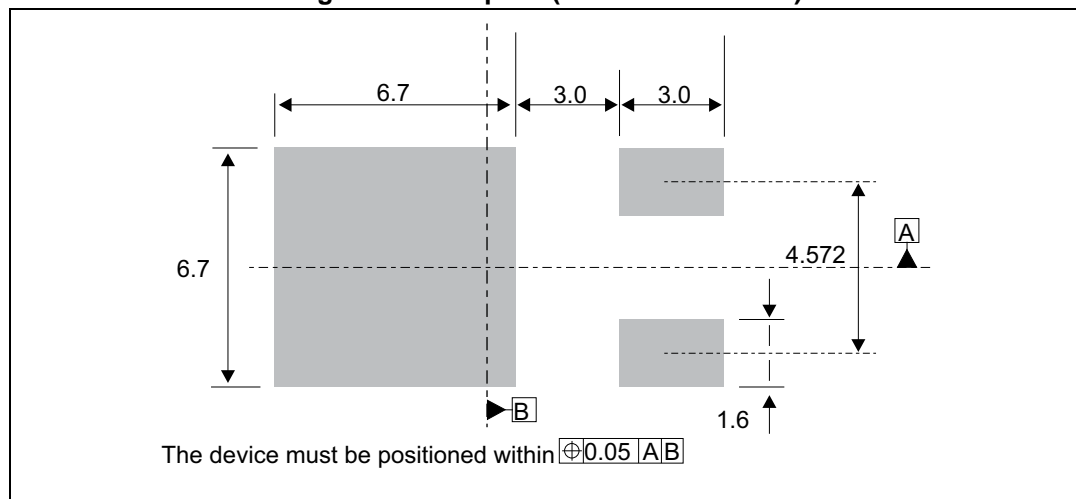

2.2 IPAK package information

Figure 14. IPAK package outline

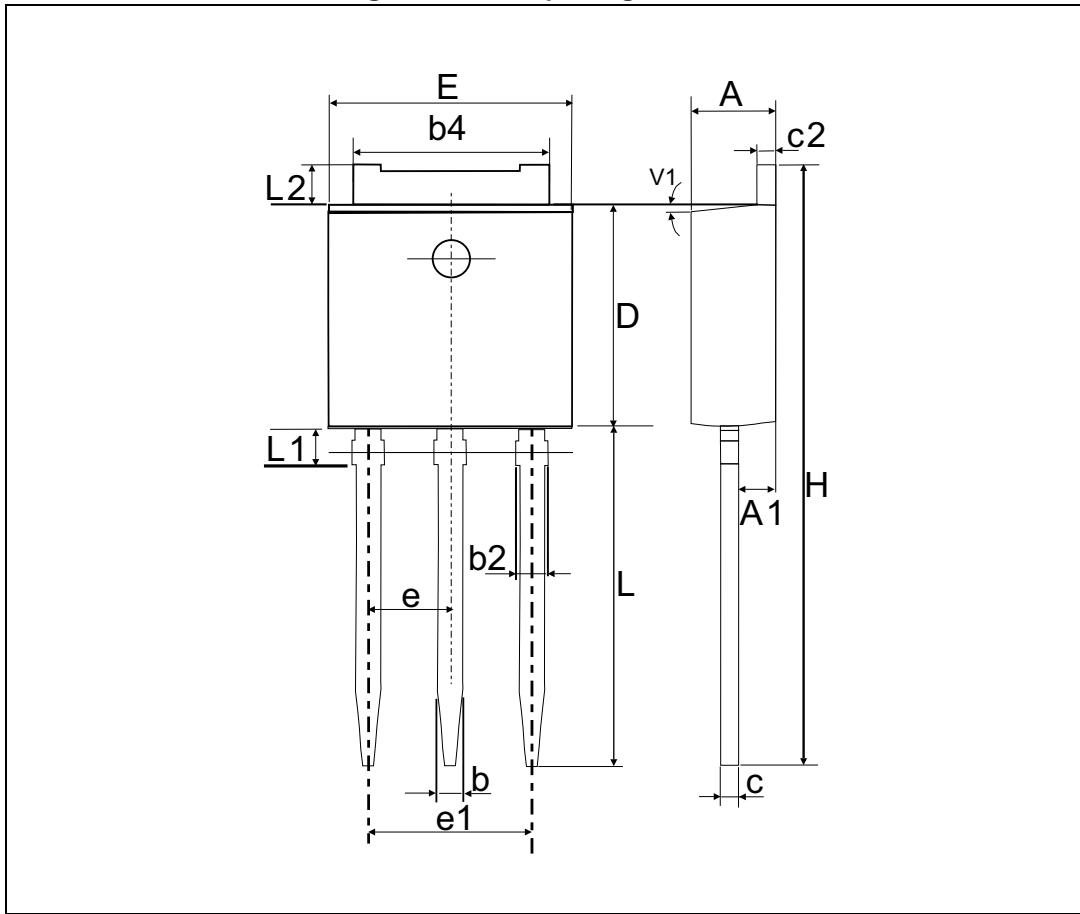

Note: This package drawing may slightly differ from the physical package. However, all the specified dimensions are guaranteed.

Table 8. IPAK package mechanical data

| Ref. | Dimensions | | | | | |
|------|-------------|-------|------|-----------------------|--------|--------|
| | Millimeters | | | Inches ⁽¹⁾ | | |
| | Min. | Typ. | Max. | Min. | Typ. | Max. |
| A | 2.20 | | 2.40 | 0.0866 | | 0.0945 |
| A1 | 0.90 | | 1.10 | 0.0354 | | 0.0433 |
| b | 0.64 | | 0.90 | 0.0252 | | 0.0354 |
| b2 | | | 0.95 | | | 0.0374 |
| b4 | 5.20 | | 5.43 | 0.2047 | | 0.2138 |
| c | 0.45 | | 0.60 | 0.0177 | | 0.0236 |
| c2 | 0.46 | | 0.60 | 0.0181 | | 0.0236 |
| D | 6 | | 6.20 | 0.2362 | | 0.2441 |
| E | 6.40 | | 6.65 | 0.2520 | | 0.2618 |
| e | | 2.28 | | | 0.0898 | |
| e1 | 4.40 | | 4.60 | 0.1732 | | 0.1811 |
| H | | 16.10 | | | 0.6339 | |
| L | 9 | | 9.60 | 0.3543 | | 0.3780 |
| L1 | 0.8 | | 1.20 | 0.0315 | | 0.0472 |
| L2 | | 0.80 | 1.25 | | 0.0315 | 0.0492 |
| V1 | | 10° | | | 10° | |

1. Inch dimensions are only for reference

2.3 TO-220AB (insulated and non-insulated) information

Figure 15. TO-220AB (insulated and non-insulated) package outline



Table 9. TO-220AB (insulated and non-insulated) package mechanical data

| Ref. | Dimensions | | | | | |
|------|-------------|-------|-------|-----------------------|--------|--------|
| | Millimeters | | | Inches ⁽¹⁾ | | |
| | Min. | Typ. | Max. | Min. | Typ. | Max. |
| A | 15.20 | | 15.90 | 0.5984 | | 0.6259 |
| a1 | | 3.75 | | | 0.1476 | |
| a2 | 13.00 | | 14.00 | 0.5118 | | 0.5511 |
| B | 10.00 | | 10.40 | 0.3937 | | 0.4094 |
| b1 | 0.61 | | 0.88 | 0.0240 | | 0.0346 |
| b2 | 1.23 | | 1.32 | 0.0484 | | 0.0519 |
| C | 4.40 | | 4.60 | 0.1732 | | 0.1811 |
| c1 | 0.49 | | 0.70 | 0.0192 | | 0.0275 |
| c2 | 2.40 | | 2.72 | 0.0944 | | 0.1070 |
| e | 2.40 | | 2.70 | 0.0944 | | 0.1062 |
| F | 6.20 | | 6.60 | 0.2440 | | 0.2598 |
| ØI | 3.73 | | 3.88 | 0.1468 | | 0.1527 |
| I4 | 15.80 | 16.40 | 16.80 | 0.6220 | 0.6456 | 0.6614 |
| L | 2.65 | | 2.95 | 0.1043 | | 0.1161 |
| I2 | 1.14 | | 1.70 | 0.0448 | | 0.0669 |
| I3 | 1.14 | | 1.70 | 0.0448 | | 0.0669 |
| M | | 2.60 | | | 0.1023 | |

1. Inch dimensions are only for reference

3 Ordering information

Figure 16. Order information scheme



Table 10. Product selector

| Part number | Voltage (xxx) | | | Sensitivity | Type | Package |
|--------------|---------------|-------|-------|-------------|-------------|----------|
| | 600 V | 700 V | 800 V | | | |
| T405-xxxB | X | | | 5 mA | Logic level | DPAK |
| T405-xxxB-TR | X | X | X | 5 mA | Logic level | DPAK |
| T405-xxxH | X | | X | 5 mA | Logic level | IPAK |
| T405-xxxT | X | | | 5 mA | Logic level | TO-220AB |
| T410-xxxB | X | | | 10 mA | Logic level | DPAK |
| T410-xxxB-TR | X | | X | 10 mA | Logic level | DPAK |
| T410-xxxH | X | | X | 10 mA | Logic level | IPAK |
| T410-xxxT | X | X | X | 10 mA | Logic level | TO-220AB |
| T435-xxxB | X | | | 35 mA | Snubberless | DPAK |
| T435-xxxB-TR | X | X | X | 35 mA | Snubberless | DPAK |
| T435-xxxH | X | | X | 35 mA | Snubberless | IPAK |
| T435-xxxT | X | | X | 35 mA | Snubberless | TO-220AB |

Blank = Unavailable

Table 11. Ordering information

| Order code | Marking | Package | Weight | Base qty. | Delivery mode | | | | |
|--------------|-----------|----------|--------|-----------|---------------|------|---------------|------|-------|
| T405-600B | T4 0560 | DPAK | 0.3 g | 75 | Tube | | | | |
| T410-600B | T4 1060 | | | | | | | | |
| T435-600B | T4 3560 | | | | | | | | |
| T405-600B-TR | T4 0560 | | | DPAK | 0.3 g | 2500 | Tape and reel | | |
| T410-600B-TR | T4 1060 | | | | | | | | |
| T435-600B-TR | T4 3560 | | | | | | | | |
| T405-700B-TR | T4 0570 | | | | | | | | |
| T435-700B-TR | T4 3570 | | | | | | | | |
| T405-800B-TR | T4 0580 | | | | | | | | |
| T410-800B-TR | T4 1080 | | | DPAK | 0.3 g | 2500 | Tape and reel | | |
| T435-800B-TR | T4 3580 | | | | | | | | |
| T405-600H | T4 0560 | | | | | | | IPAK | 0.4 g |
| T410-600H | T4 1060 | | | | | | | | |
| T435-600H | T4 3560 | | | | | | | | |
| T405-800H | T4 0580 | | | | | | | | |
| T410-800H | T4 1080 | | | | | | | | |
| T435-800H | T4 3580 | | | | | | | | |
| T405-600T | T405-600T | TO-220AB | 2.3 g | 50 | Tube | | | | |
| T410-600T | T410-600T | | | | | | | | |
| T435-600T | T435-600T | | | | | | | | |
| T410-700T | T410-700T | | | | | | | | |
| T410-800T | T410-800T | | | | | | | | |
| T435-800T | T435-800T | | | | | | | | |

4 Revision history

Table 12. Document revision history

| Date | Revision | Changes |
|-------------|----------|--|
| Jun-2003 | 2 | Last updated. |
| 25-Mar-2005 | 3 | Layout updated, No content change. |
| 25-Jan-2006 | 4 | Markings changed in <i>Table 12</i> . |
| 14-May-2014 | 5 | Updated DPAK and IPAK package information and reformatted to current standard. |
| 11-Feb-2015 | 6 | Updated package silhouettes in cover page. |
| 1-Apr-2016 | 7 | Removed ISOWATT-220AB package information. |
| 05-Oct-2016 | 8 | Updated <i>Table 3</i> and <i>Table 11</i> . Updated <i>Figure 2</i> and <i>Figure 4</i> . |
| 14-Nov-2016 | 9 | Updated <i>Table 1</i> . |

IMPORTANT NOTICE – PLEASE READ CAREFULLY

STMicroelectronics NV and its subsidiaries ("ST") reserve the right to make changes, corrections, enhancements, modifications, and improvements to ST products and/or to this document at any time without notice. Purchasers should obtain the latest relevant information on ST products before placing orders. ST products are sold pursuant to ST's terms and conditions of sale in place at the time of order acknowledgement.

Purchasers are solely responsible for the choice, selection, and use of ST products and ST assumes no liability for application assistance or the design of Purchasers' products.

No license, express or implied, to any intellectual property right is granted by ST herein.

Resale of ST products with provisions different from the information set forth herein shall void any warranty granted by ST for such product.

ST and the ST logo are trademarks of ST. All other product or service names are the property of their respective owners.

Information in this document supersedes and replaces information previously supplied in any prior versions of this document.

© 2016 STMicroelectronics – All rights reserved