

**BMR45' series** Fully regulated Advanced Bus Converters  
 Input 36-75 V, Output up to 60 A / 396 W

EN/LZT 146 395 R10A September 2017

© Flex

### Key Features

- Industry standard five pin Quarter-brick  
 57.9 x 36.8 x 11.6 mm (2.28 x 1.45 x 0.46 in.)
- Optional digital PMBus interface
- Fully regulated intermediate bus converter
- High efficiency, typ. 96% at half load, 12 Vout
- +/- 2% output voltage tolerance band
- 1500 Vdc input to output isolation
- 2.5 million hours MTBF
- Optional baseplate
- Optional output voltage Droop for parallel operation
- ISO 9001/14001 certified supplier
- PMBus Revision 1.1 compliant

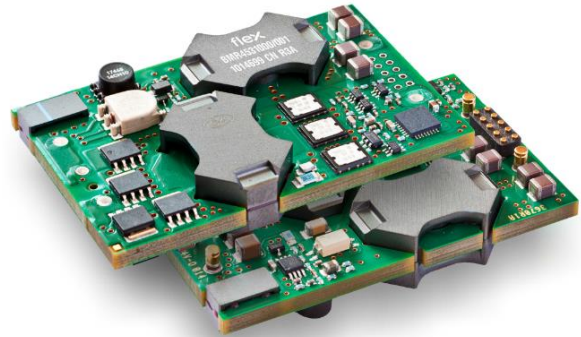

### Power Management

- Configurable soft start/stop
- Precision delay and ramp-up
- Voltage sequencing and margining
- Voltage/current/temperature monitoring
- Configurable output voltage
- Power good
- Synchronization
- Voltage track



### Safety Approvals



### Design for Environment



Meets requirements in high-temperature lead-free soldering processes.

### Contents

Ordering Information	2
General Information	2
Safety Specification	4
Absolute Maximum Ratings	5
Functional Description	6
Electrical Specification	
3.3 V, 60 A / 198 W	BMR 453 0002/003..... 7
5 V, 60 A / 300 W	BMR 453 0002/004..... 10
9 V, 33 A / 297 W	BMR 453 0000/002..... 13
12 V, 33 A / 396 W	BMR 453 0000/001..... 16
EMC Specification	19
Operating Information	20
Thermal considerations	23
Connections	24
PMBus communications	25
Mechanical Information	28
Soldering Information	32
Delivery Information	33
Product Qualification Specification	35

### BMR45' series Fully regulated Advanced Bus Converters Input 36-75 V, Output up to 60 A / 396 W

EN/LZT 146 395 R10A September 2017

© Flex

#### Ordering Information

Product program	Output
BMR4530002/003	3.3 V / 60 A, 198 W
BMR4530002/004	5 V / 60 A, 300 W
BMR4530000/002	9 V / 33 A, 297 W
BMR4530006/012	9.6 V / 33 A, 297 W
BMR4530000/001	12 V / 33 A, 396 W
BMR4530006/013	12 V / 33 A, 376 W
BMR4530006/014	12.45 V / 33 A, 391 W

#### Product Number and Packaging

BMR453	n <sub>1</sub>	n <sub>2</sub>	n <sub>3</sub>	n <sub>4</sub>	/	n <sub>5</sub>	n <sub>6</sub>	n <sub>7</sub>
Mechanical pin option	x				/			
Mechanical option		x			/			
Hardware option			x	x	/			
Configuration file					/	x	x	x

#### Optional designation Description

n <sub>1</sub>	0 = Standard pin length 5.33 mm (0.210 in.) 1 = Surface mount option <sup>note 1</sup> 2 = Lead length 3.69 mm (0.145 in.) 3 = Lead length 4.57 mm (0.180 in.) 4 = Lead length 2.79 mm (0.110 in.) (cut) 5 = Lead length 2.79 mm (0.210 in.) stand off 6.7 mm
n <sub>2</sub>	0 = Open frame 1 = Baseplate 2 = Baseplate with GND-pin
n <sub>3</sub> n <sub>4</sub>	00 = 8.1-13.2 Vout With digital interface 01 = 8.1-13.2 Vout Without digital interface 02 = 3-6.7 Vout With digital interface 03 = 3-6.7 Vout Without digital interface 06 = 8.1-13.2 Vout With 0.6 V droop load sharing function Without digital interface 07 = 8.1-13.2 Vout With 0.6 V droop load sharing function With digital interface
n <sub>5</sub> n <sub>6</sub> n <sub>7</sub>	001 = 12 V Standard configuration 002 = 9 V Standard configuration 003 = 3.3 V Standard configuration 004 = 5 V Standard configuration 007 = 9 V with positive RC logic configuration 008 = 12 V with positive RC logic configuration 009 = 3.3 V with positive RC logic configuration 010 = 5 V with positive RC logic configuration 012 = 9.6 V with 0.6 V droop load sharing function configuration (available only for n <sub>3</sub> n <sub>4</sub> = 06 or 07) 013 = 12 V with 0.6 V droop load sharing function configuration (Vin 40-75, available, only for n <sub>3</sub> n <sub>4</sub> = 06 or 07) 014 = 12.45 V with 0.6 V droop load sharing function configuration

(Vin 40-75, available only for n<sub>3</sub>n<sub>4</sub> = 06 or 07)

xxx = Application Specific Configuration

Packaging 20 converters/tray/box PE foam dissipative

Example: Product number BMR4532000/002 equals an Through hole mount lead length 3.69 mm (cut), open frame, digital interface with 9 V standard configuration variant.

Note 1: Surface mount option available for 8.1-13.2Vout open frame version. Can not be combined with base plate option.

For application specific configurations contact your local Flex sales representative.

#### General Information

##### Reliability

The failure rate ( $\lambda$ ) and mean time between failures (MTBF =  $1/\lambda$ ) is calculated at max output power and an operating ambient temperature ( $T_A$ ) of +40°C. Flex uses Telcordia SR-332 Issue 2 Method 1 to calculate the mean steady-state failure rate and standard deviation ( $\sigma$ ).

Telcordia SR-332 Issue 2 also provides techniques to estimate the upper confidence levels of failure rates based on the mean and standard deviation.

Mean steady-state failure rate, $\lambda$	Std. deviation, $\sigma$
403 nFailures/h	61 nFailures/h

MTBF (mean value) for the BMR453 series = 2.5 Mh.  
MTBF at 90% confidence level = 2.1 Mh

##### Compatibility with RoHS requirements

The products are compatible with the relevant clauses and requirements of the RoHS directive 2011/65/EU and have a maximum concentration value of 0.1% by weight in homogeneous materials for lead, mercury, hexavalent chromium, PBB and PBDE and of 0.01% by weight in homogeneous materials for cadmium.

Exemptions in the RoHS directive utilized in Flex products are found in the Statement of Compliance document.

Flex fulfills and will continuously fulfill all its obligations under regulation (EC) No 1907/2006 concerning the registration, evaluation, authorization and restriction of chemicals (REACH) as they enter into force and is through product materials declarations preparing for the obligations to communicate information on substances in the products.

**BMR45' series** Fully regulated Advanced Bus Converters  
Input 36-75 V, Output up to 60 A / 396 W

EN/LZT 146 395 R10A September 2017

© Flex

### Quality Statement

The products are designed and manufactured in an industrial environment where quality systems and methods like ISO 9000, Six Sigma, and SPC are intensively in use to boost the continuous improvements strategy. Infant mortality or early failures in the products are screened out and they are subjected to an ATE-based final test. Conservative design rules, design reviews and product qualifications, plus the high competence of an engaged work force, contribute to the high quality of the products.

### Warranty

Warranty period and conditions are defined in Flex General Terms and Conditions of Sale.

### Limitation of Liability

Flex does not make any other warranties, expressed or implied including any warranty of merchantability or fitness for a particular purpose (including, but not limited to, use in life support applications, where malfunctions of product can cause injury to a person's health or life).

### © Flex 2017

The information and specifications in this technical specification is believed to be correct at the time of publication. However, no liability is accepted for inaccuracies, printing errors or for any consequences thereof. Flex reserves the right to change the contents of this technical specification at any time without prior notice.

<b>BMR45' series Fully regulated Advanced Bus Converters</b> Input 36-75 V, Output up to 60 A / 396 W	EN/LZT 146 395 R10A September 2017
	© Flex

## Safety Specification

### General information

Flex DC/DC converters and DC/DC regulators are designed in accordance with the safety standards IEC 60950-1, EN 60950-1 and UL 60950-1 *Safety of Information Technology Equipment*.

IEC/EN/UL 60950-1 contains requirements to prevent injury or damage due to the following hazards:

- Electrical shock
- Energy hazards
- Fire
- Mechanical and heat hazards
- Radiation hazards
- Chemical hazards

On-board DC/DC converters and DC/DC regulators are defined as component power supplies. As components they cannot fully comply with the provisions of any safety requirements without "conditions of acceptability". Clearance between conductors and between conductive parts of the component power supply and conductors on the board in the final product must meet the applicable safety requirements. Certain conditions of acceptability apply for component power supplies with limited stand-off (see Mechanical Information and Safety Certificate for further information). It is the responsibility of the installer to ensure that the final product housing these components complies with the requirements of all applicable safety standards and regulations for the final product.

Component power supplies for general use should comply with the requirements in IEC/EN/UL 60950-1 *Safety of Information Technology Equipment*. Product related standards, e.g. IEEE 802.3af *Power over Ethernet*, and ETS-300132-2 *Power interface at the input to telecom equipment, operated by direct current (dc)* are based on IEC/EN/UL 60950-1 with regards to safety.

Flex DC/DC converters, Power interface modules and DC/DC regulators are UL 60950-1 recognized and certified in accordance with EN 60950-1. The flammability rating for all construction parts of the products meet requirements for V-0 class material according to IEC 60695-11-10, *Fire hazard testing, test flames – 50 W horizontal and vertical flame test methods*.

### Isolated DC/DC converters & Power interface modules

The product may provide basic or functional insulation between input and output according to IEC/EN/UL 60950-1 (see Safety Certificate), different conditions shall be met if the output of a basic or a functional insulated product shall be considered as safety extra low voltage (SELV).

For basic insulated products (see Safety Certificate) the

output is considered as safety extra low voltage (SELV) if one of the following conditions is met:

- The input source provides supplementary or double or reinforced insulation from the AC mains according to IEC/EN/UL 60950-1.
- The input source provides functional or basic insulation from the AC mains and the product's output is reliably connected to protective earth according to IEC/EN/UL 60950-1.

For functional insulated products (see Safety Certificate) the output is considered as safety extra low voltage (SELV) if one of the following conditions is met:

- The input source provides double or reinforced insulation from the AC mains according to IEC/EN/UL 60950-1.
- The input source provides basic or supplementary insulation from the AC mains and the product's output is reliably connected to protective earth according to IEC/EN/UL 60950-1.
- The input source is reliably connected to protective earth and provides basic or supplementary insulation according to IEC/EN/UL 60950-1 and the maximum input source voltage is 60 Vdc.

Galvanic isolation between input and output is verified in an electric strength test and the isolation voltage ( $V_{iso}$ ) meets the voltage strength requirement for basic insulation according to IEC/EN/UL 60950-1.

It is recommended to use a slow blow fuse at the input of each DC/DC converter. If an input filter is used in the circuit the fuse should be placed in front of the input filter. In the rare event of a component problem that imposes a short circuit on the input source, this fuse will provide the following functions:

- Isolate the fault from the input power source so as not to affect the operation of other parts of the system
- Protect the distribution wiring from excessive current and power loss thus preventing hazardous overheating

### Non - isolated DC/DC regulators

The DC/DC regulator output is SELV if the input source meets the requirements for SELV circuits according to IEC/EN/UL 60950-1.

**BMR45' series** Fully regulated Advanced Bus Converters  
 Input 36-75 V, Output up to 60 A / 396 W

EN/LZT 146 395 R10A September 2017

© Flex

### Absolute Maximum Ratings

Characteristics		min	typ	max	Unit
$T_{P1}$	Operating Temperature (see Thermal Consideration section)	-40		+125	°C
$T_s$	Storage temperature	-55		+125	°C
$V_I$	Input voltage	-0.5		80	V
$V_{iso}$	Isolation voltage (input to output test voltage), see note 1			1500	Vdc
$V_{tr}$	Input voltage transient ( $T_p$ 100 ms)			100	V
$V_{RC}$	Remote Control pin voltage	-0.3		18	V
$V_{IO}^{Logic}$	SALERT, CTRL, SYNC, SCL, SDA, SA(0,1)	-0.3		3.6	V

Stress in excess of Absolute Maximum Ratings may cause permanent damage. Absolute Maximum Ratings, sometimes referred to as no destruction limits, are normally tested with one parameter at a time exceeding the limits of Output data or Electrical Characteristics. If exposed to stress above these limits, function and performance may degrade in an unspecified manner.

Note 1: Isolation voltage (input/output to base-plate) max 750 Vdc.

### Fundamental Circuit Diagram

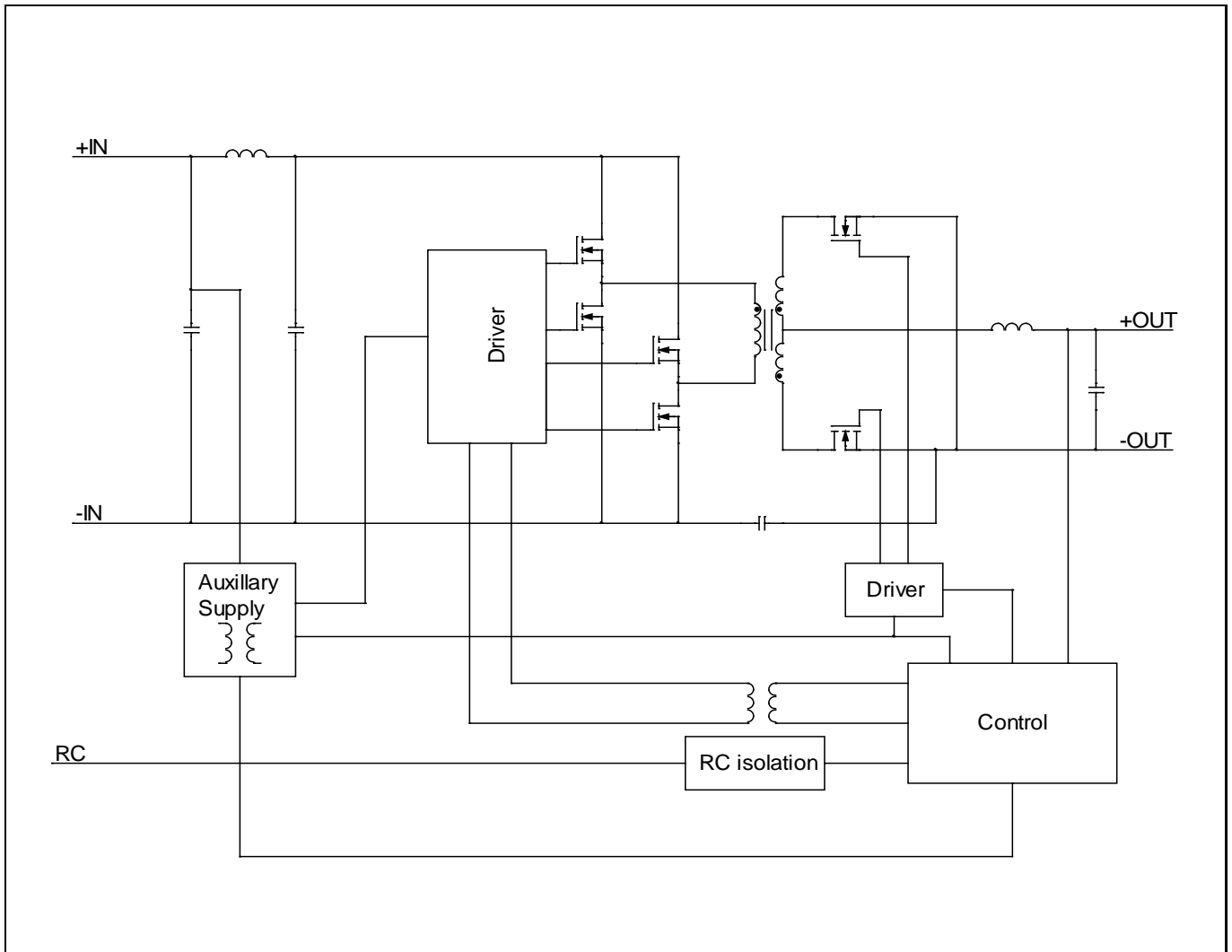

**BMR45' series Fully regulated Advanced Bus Converters**  
 Input 36-75 V, Output up to 60 A / 396 W

EN/LZT 146 395 R10A September 2017

© Flex

**Functional Description**

$T_{P1} = -40$  to  $+90^{\circ}\text{C}$ ,  $V_I = 36$  to  $75$  V, sense pins connected to output pins unless otherwise specified under Conditions.  
 Typical values given at:  $T_{P1} = +25^{\circ}\text{C}$ ,  $V_I = 53$  V, max  $I_O$ , unless otherwise specified under Conditions  
 Configuration File: 190 10-CDA 102 935/001 rev D

Characteristics		Conditions	min	typ	max	Unit
<b>PMBus monitoring accuracy</b>						
VIN_READ	Input voltage		-3	+0.4	3	%
VOUT_READ	Output voltage	$V_I = 53$ V	-1.0	-0.3	1.0	%
IOUT_READ	Output current	$V_I = 53$ V, 50-100% of max $I_O$	-6	$\pm 1$	6	%
IOUT_READ	Output current	$V_I = 53$ V, 10% of max $I_O$	-0.7	-	0.7	A
TEMP_READ	Temperature		-5	-	5	$^{\circ}\text{C}$
<b>Fault Protection Characteristics</b>						
Input Under Voltage Lockout, UVLO	Factory default		-	33	-	V
	Setpoint accuracy		-3	-	3	%
	Hysteresis	Factory default	-	1.8	-	V
		Configurable via PMBus of threshold range, Note 1	0	-	-	V
Delay		-	200	-	$\mu\text{s}$	
(Output voltage) Over/Under Voltage Protection, OVP/UVLP	VOUT_UV_FAULT_LIMIT	Factory default	-	0	-	V
		Configurable via PMBus, Note 1	0	-	16	V
	VOUT_OV_FAULT_LIMIT	Factory default	-	15.6	-	V
		Configurable via PMBus, Note 1	$V_{\text{OUT}}$	-	16	V
fault response time		-	200	-	$\mu\text{s}$	
Over Current Protection, OCP	Setpoint accuracy	$I_O$	-6	-	6	%
	IOUT_OC_FAULT_LIMIT	Factory default	-	38	-	A
		Configurable via PMBus, Note 1	0	-	100	A
fault response time		-	200	-	$\mu\text{s}$	
Over Temperature Protection, OTP	OTP_FAULT_LIMIT	Factory default	-	135	-	$^{\circ}\text{C}$
		Configurable via PMBus, Note 1	-50	-	135	
	OTP hysteresis	Factory default	-	10	-	
		Configurable via PMBus, Note 1	0	-	165	
fault response time		-	200	-	$\mu\text{s}$	
<b>Logic Input/Output Characteristics</b>						
Logic input low ( $V_{IL}$ )	CTRL_CS, SA0, SA1, PG_SYNC, SCL, SDA,		-	-	0.8	V
Logic input high ( $V_{IH}$ )			2.0	-	-	V
Logic output low ( $V_{OL}$ )	CTRL_CS, PG_SYNC, SALERT, SCL, SDA $I_{OL} = 5$ mA		-	-	0.4	V
Logic output high ( $V_{OH}$ )	CTRL_CS, PG_SYNC, SALERT, SCL, SDA $I_{OH} = -5$ mA		2.8	-	-	V
Setup time, SMBus			100	-	-	ns
Hold time, SMBus			300	-	-	ns
Bus free time T(BUF)	Note 2		200	-	-	us

Note 1: See Operating Information section.

Note 2: It is recommended that a PMBus master read back written data for verification i.e. do not rely on the ACK/NACK bit since this bit are as susceptible to errors as any other bit\*. However, under very rare operating conditions, it is possible to get intermittent read back failures. It is therefore recommended to implement error handling in the master that also deals with those situations.

**BMR45' series Fully regulated Advanced Bus Converters**  
Input 36-75 V, Output up to 60 A / 396 W

EN/LZT 146 395 R10A September 2017

© Flex

**3.3V, 60A / 198W Electrical Specification**

**BMR 453 0002/003**

$T_{P1} = -40$  to  $+90^{\circ}\text{C}$ ,  $V_I = 36$  to  $75$  V, sense pins connected to output pins unless otherwise specified under Conditions.

Typical values given at:  $T_{P1} = +25^{\circ}\text{C}$ ,  $V_I = 53$  V,  $I_O = \text{max}$ , unless otherwise specified under Conditions.

Additional  $C_{out} = 0.1$  mF, Configuration File: 190 10-CDA 102 935/003 rev B

Characteristics		Conditions	min	typ	max	Unit
$V_I$	Input voltage range		36		75	V
$V_{loff}$	Turn-off input voltage	Decreasing input voltage	32	33	34	V
$V_{lon}$	Turn-on input voltage	Increasing input voltage	34	35	36	V
$C_i$	Internal input capacitance			10		$\mu\text{F}$
$P_O$	Output power		0		198	W
$\eta$	Efficiency	50% of $I_O$		94.7		%
		$I_O$		93.3		
		50% of $I_O$ , $V_I = 48$ V		94.9		
		$I_O$ , $V_I = 48$ V		93.3		
$P_d$	Power Dissipation	$I_O$		14.1	20.8	W
$P_{li}$	Input idling power	$I_O = 0$ A, $V_I = 53$ V		1.7		W
$P_{RC}$	Input standby power	$V_I = 53$ V (turned off with RC)		123		mW
$f_s$	Default switching frequency	0-100% of $I_O$ see Note 1	171	180	189	kHz

$V_{\alpha}$	Output voltage initial setting and accuracy	$T_{P1} = +25^{\circ}\text{C}$ , $V_I = 53$ V, $I_O = 60$ A	3.26	3.3	3.36	V
$V_O$	Output adjust range	See operating information	3.0		6.7	V
	Output voltage tolerance band	0-100% of $I_O$	3.22		3.38	V
	Line regulation	$I_O$		4	16	mV
	Load regulation	$V_I = 53$ V, 1-100% of $I_O$		4	12	mV
$V_{tr}$	Load transient voltage deviation	$V_I = 53$ V, Load step 25-75-25% of $I_O$ , $di/dt = 1$ A/ $\mu\text{s}$ , see Note 2		$\pm 0.2$		V
$t_{tr}$	Load transient recovery time			250		$\mu\text{s}$
$t_r$	Ramp-up time (from 10-90% of $V_O$ )	10-100% of $I_O$ , $T_{P1} = 25^{\circ}\text{C}$ , $V_I = 53$ V see Note 3		8		ms
$t_s$	Start-up time (from $V_I$ connection to 90% of $V_O$ )			140		ms
$t_f$	Vin shutdown fall time (from $V_I$ off to 10% of $V_O$ )	$I_O$		0.2		ms
		$I_O = 0$ A		4.5		s
$t_{RC}$	RC start-up time	$I_O$		52		ms
		$I_O$		3		ms
		$I_O = 0$ A		4.5		s
$I_O$	Output current		0		60	A
$I_{lim}$	Current limit threshold	$V_O = 3.0$ V, $T_{P1} < \text{max } T_{P1}$	61	66	82	A
$I_{sc}$	Short circuit current	$T_{P1} = 25^{\circ}\text{C}$ , $V_O < 0.2$ V, see Note 4		11		A
$C_{out}$	Recommended Capacitive Load	$T_{P1} = 25^{\circ}\text{C}$ , see Note 5	0.1	6	10	mF
$V_{Oac}$	Output ripple & noise	See ripple & noise section, $I_O$ , $V_{\alpha}$		30	100	mVp-p
OVP	Over voltage protection	$T_{P1} = +25^{\circ}\text{C}$ , $V_I = 53$ V, 10-100% of $I_O$ , see Note 6		4.6		V

Note 1: Frequency may be adjusted via PMBus, see Operating Information section.

Note 2:  $C_{out} = 6$  mF used at load transient test.

Note 3: Start-up and Ramp-up time can be increased via PMBus, see Operation Information section.

Note 4: RMS current in hiccup mode.

Note 5: Low ESR-value.

Note 6: OVP-level can be adjusted via PMBus, see Operation Information.

**BMR45' series** Fully regulated Advanced Bus Converters  
 Input 36-75 V, Output up to 60 A / 396 W

EN/LZT 146 395 R10A September 2017

© Flex

### 3.3V, 60A / 198W Electrical Specification

**BMR 453 0002/003**

#### Efficiency

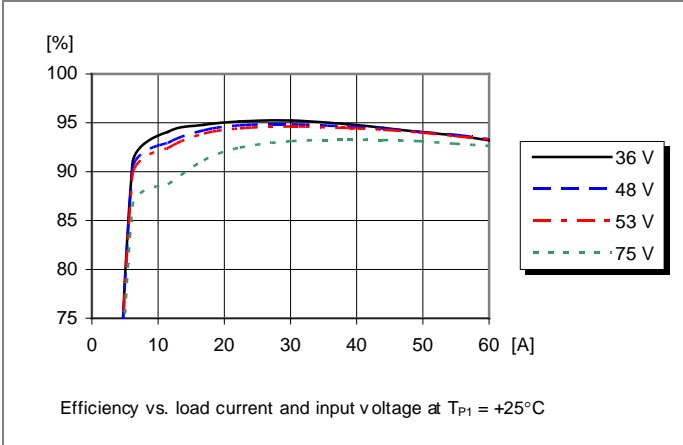

#### Power Dissipation

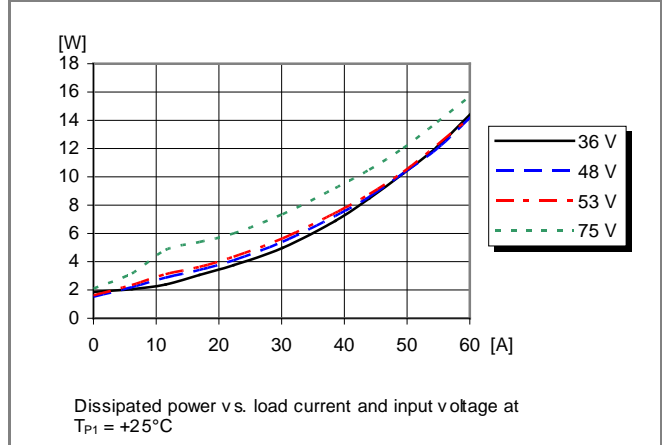

#### Output Current Derating, open frame

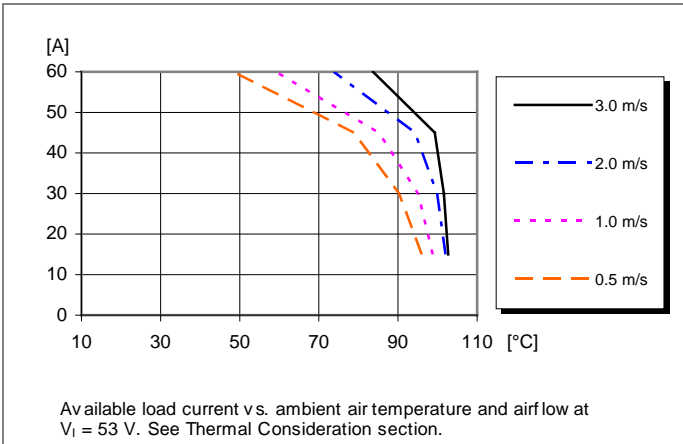

#### Output Current Derating, base plate option

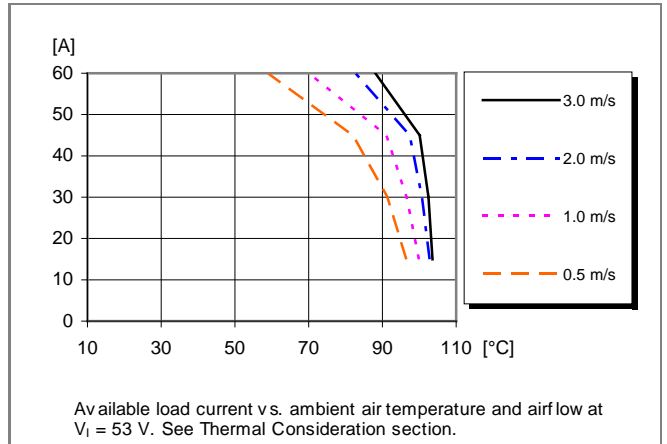

#### Thermal Resistance, base plate option

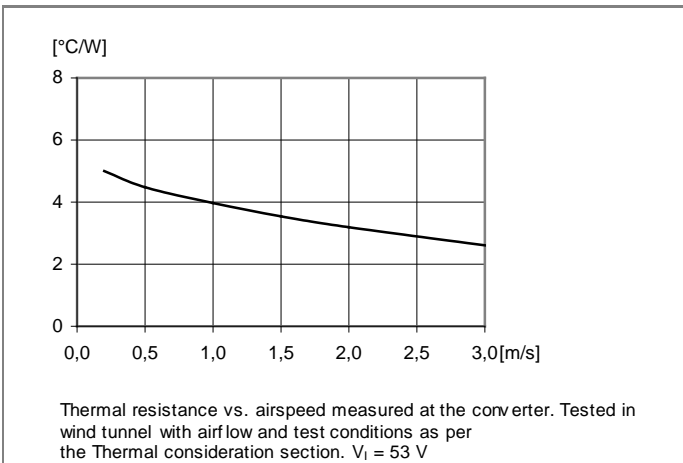



**BMR45' series** Fully regulated Advanced Bus Converters  
 Input 36-75 V, Output up to 60 A / 396 W

EN/LZT 146 395 R10A September 2017

© Flex

### 3.3V, 60A / 198W Electrical Specification

**BMR 453 0002/003**

#### Output Characteristics

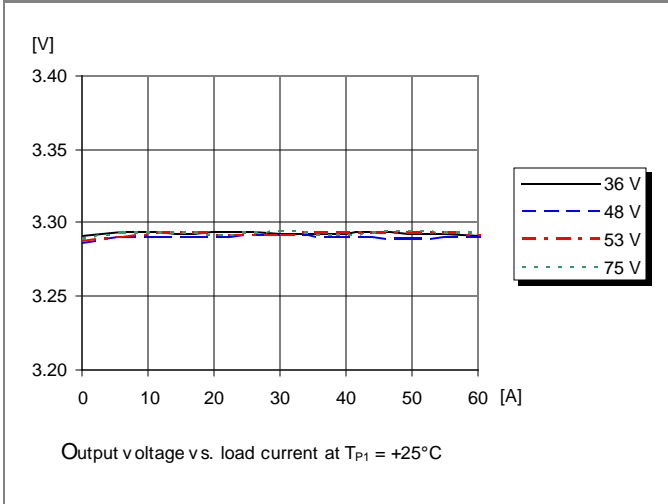

#### Current Limit Characteristics

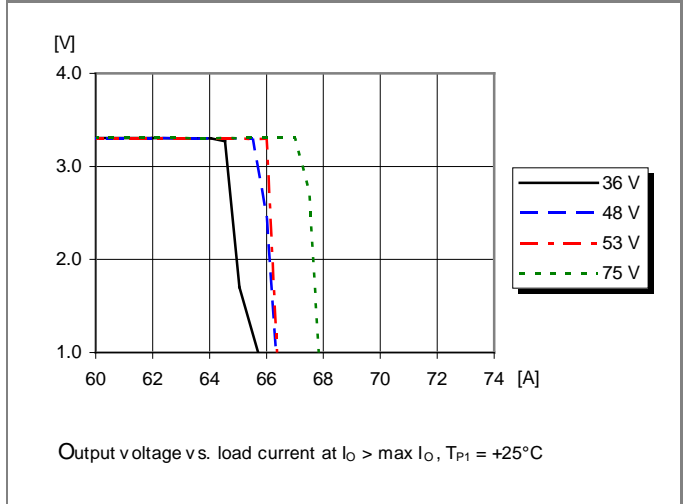

#### Start-up

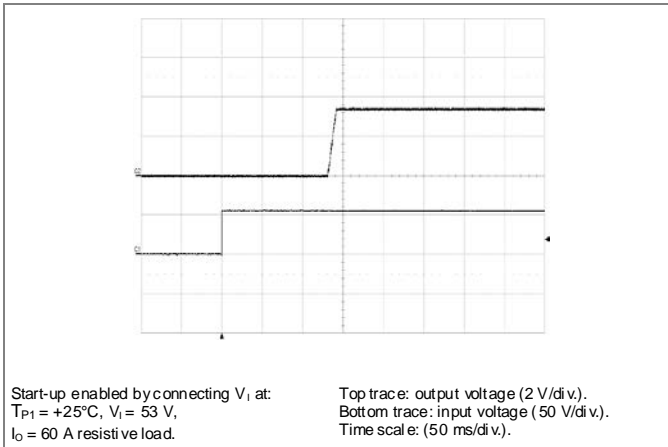

#### Shut-down

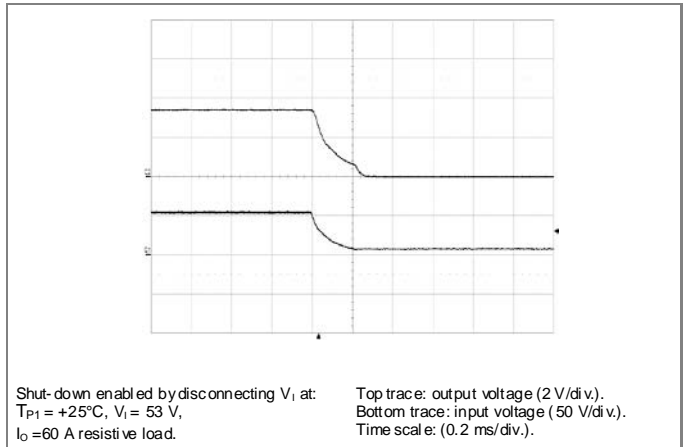

#### Output Ripple & Noise

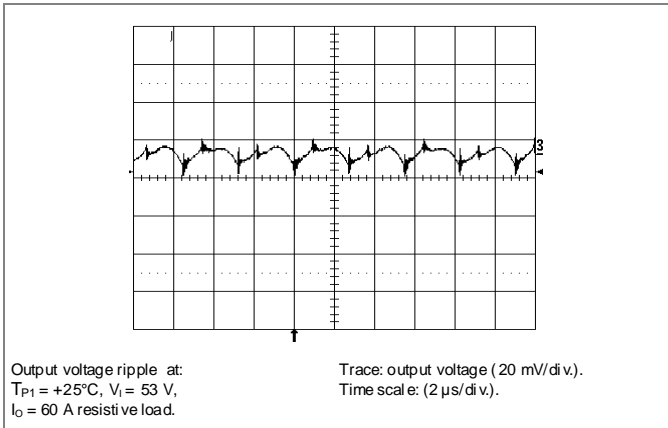

#### Output Load Transient Response

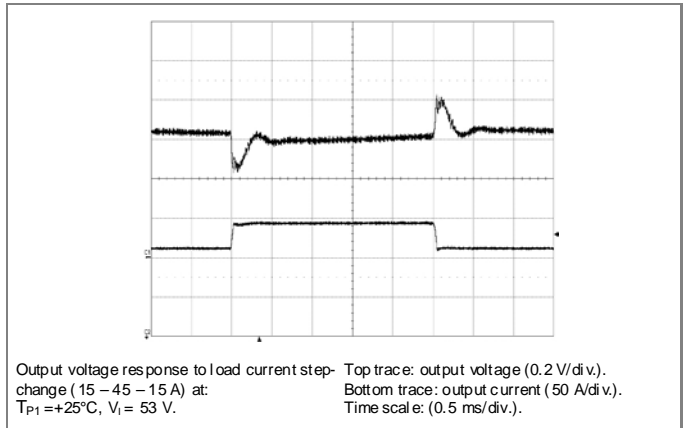

**BMR45' series Fully regulated Advanced Bus Converters**  
 Input 36-75 V, Output up to 60 A / 396 W

EN/LZT 146 395 R10A September 2017

© Flex

**5.0V, 60A / 300W Electrical Specification**

**BMR 453 0002/004**

$T_{P1} = -40$  to  $+90^{\circ}\text{C}$ ,  $V_I = 36$  to  $75$  V, sense pins connected to output pins unless otherwise specified under Conditions.

Typical values given at:  $T_{P1} = +25^{\circ}\text{C}$ ,  $V_I = 53$  V,  $I_O = \text{max}$ , unless otherwise specified under Conditions.

Additional  $C_{out} = 0.1$  mF, Configuration File: 190 10-CDA 102 935/004 rev B

Characteristics		Conditions	min	typ	max	Unit
$V_I$	Input voltage range		36		75	V
$V_{loff}$	Turn-off input voltage	Decreasing input voltage	32	33	34	V
$V_{lon}$	Turn-on input voltage	Increasing input voltage	34	35	36	V
$C_i$	Internal input capacitance			10		$\mu\text{F}$
$P_O$	Output power		0		300	W
$\eta$	Efficiency	50% of $I_O$		96.0		%
		$I_O$		94.8		
		50% of $I_O$ , $V_I = 48$ V		96.1		
		$I_O$ , $V_I = 48$ V		94.8		
$P_d$	Power Dissipation	$I_O$		16.5	22.8	W
$P_{li}$	Input idling power	$I_O = 0$ A, $V_I = 53$ V		1.9		W
$P_{RC}$	Input standby power	$V_I = 53$ V (turned off with RC)		143		mW
$f_s$	Default switching frequency	0-100% of $I_O$ see Note 1	171	180	189	kHz

$V_{\alpha}$	Output voltage initial setting and accuracy	$T_{P1} = +25^{\circ}\text{C}$ , $V_I = 53$ V, $I_O = 60$ A	4.95	5.0	5.05	V
$V_O$	Output adjust range	See operating information	3.0		6.7	V
	Output voltage tolerance band	0-100% of $I_O$	4.9		5.1	V
	Line regulation	$I_O$		3	19	mV
	Load regulation	$V_I = 53$ V, 1-100% of $I_O$		6	12	mV
$V_{tr}$	Load transient voltage deviation	$V_I = 53$ V, Load step 25-75-25% of $I_O$ , $di/dt = 1$ A/ $\mu\text{s}$ , see Note 2		$\pm 0.2$		V
$t_{tr}$	Load transient recovery time			200		$\mu\text{s}$
$t_r$	Ramp-up time (from 10-90% of $V_O$ )	10-100% of $I_O$ , $T_{P1} = 25^{\circ}\text{C}$ , $V_I = 53$ V		8		ms
$t_s$	Start-up time (from $V_I$ connection to 90% of $V_O$ )	see Note 3		140		ms
$t_f$	Vin shutdown fall time (from $V_I$ off to 10% of $V_O$ )	$I_O$		0.2		ms
		$I_O = 0$ A		4.5		s
$t_{RC}$	RC start-up time	$I_O$		53		ms
		$I_O$		2		ms
		$I_O = 0$ A		4.5		s
$I_O$	Output current		0		60	A
$I_{lim}$	Current limit threshold	$V_O = 4.5$ V, $T_{P1} < \text{max } T_{P1}$	61	66	82	A
$I_{sc}$	Short circuit current	$T_{P1} = 25^{\circ}\text{C}$ , $V_O < 0.2$ V, see Note 4		11		A
$C_{out}$	Recommended Capacitive Load	$T_{P1} = 25^{\circ}\text{C}$ , see Note 5	0.1	6	10	mF
$V_{Oac}$	Output ripple & noise	See ripple & noise section, $I_O$ , $V_{\alpha}$		25	100	mVp-p
OVP	Over voltage protection	$T_{P1} = +25^{\circ}\text{C}$ , $V_I = 53$ V, 10-100% of $I_O$ , see Note 6		6.8		V

Note 1: Frequency may be adjusted via PMBus, see Operating Information section.

Note 2:  $C_{out} = 6$  mF used at load transient test.

Note 3: Start-up and Ramp-up time can be increased via PMBus, see Operation Information section.

Note 4: RMS current in hiccup mode.

Note 5: Low ESR-value.

Note 6: OVP-level can be adjusted via PMBus, see Operation Information.

**BMR45' series** Fully regulated Advanced Bus Converters  
 Input 36-75 V, Output up to 60 A / 396 W

EN/LZT 146 395 R10A September 2017

© Flex

### 5.0V, 60A / 300W Electrical Specification

**BMR 453 0002/004**

#### Efficiency

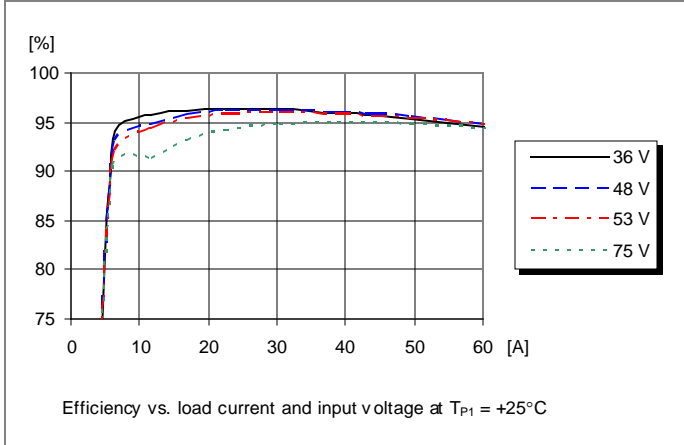

#### Power Dissipation

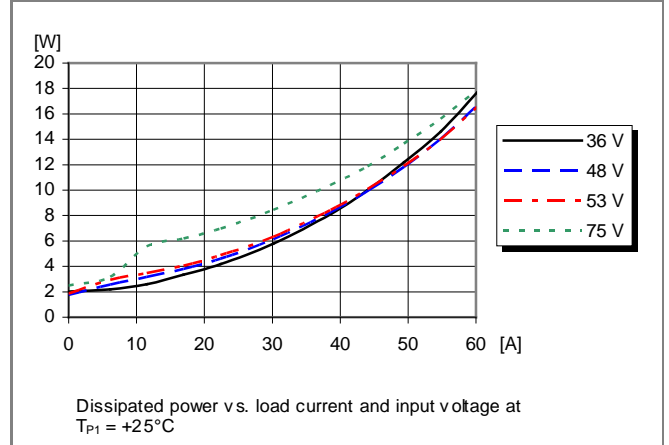

#### Output Current Derating, open frame

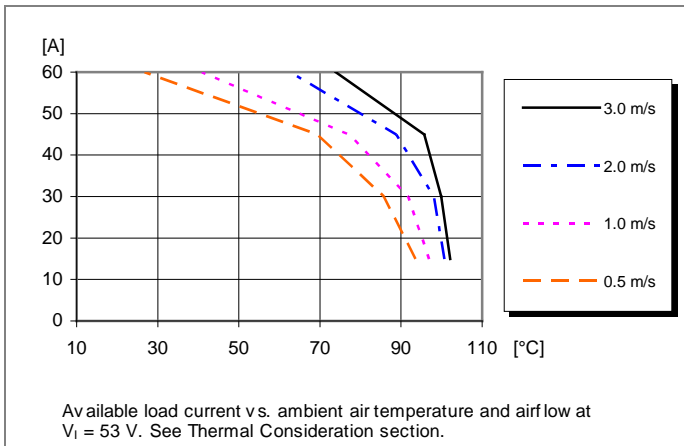

#### Output Current Derating, base plate option

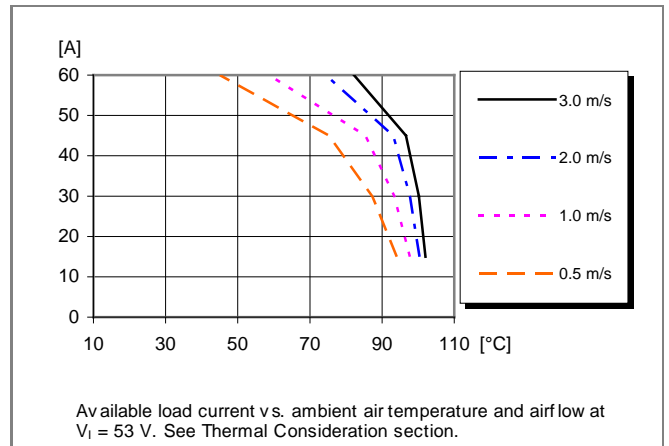

#### Thermal Resistance, base plate option

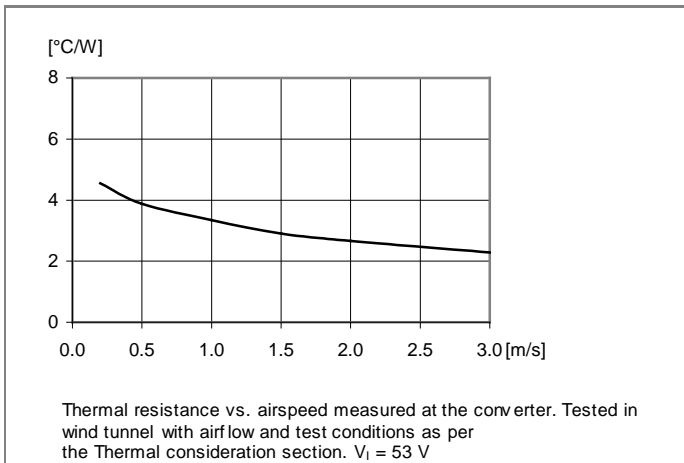

**BMR45' series** Fully regulated Advanced Bus Converters  
 Input 36-75 V, Output up to 60 A / 396 W

EN/LZT 146 395 R10A September 2017

© Flex

### 5.0V, 60A / 300W Electrical Specification

**BMR 453 0002/004**

#### Output Characteristics

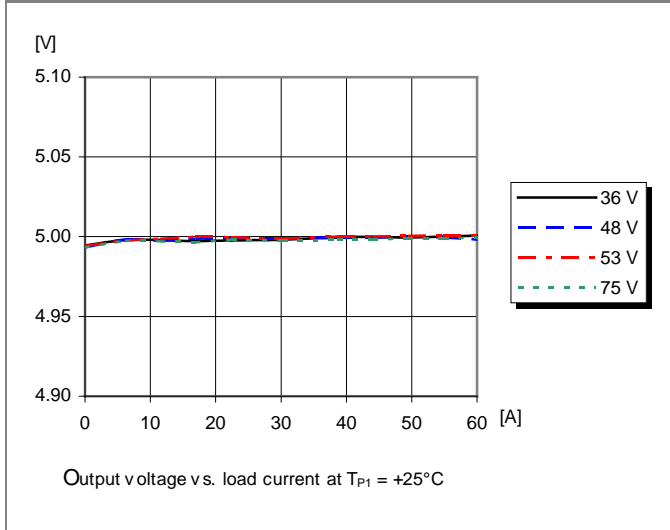

#### Current Limit Characteristics

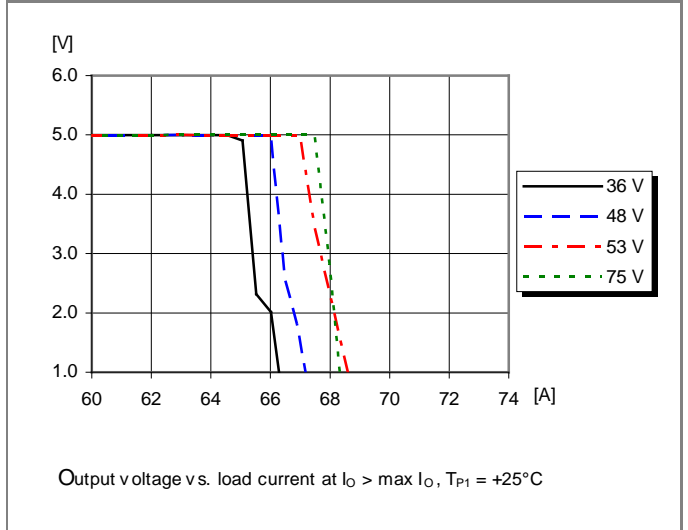

#### Start-up

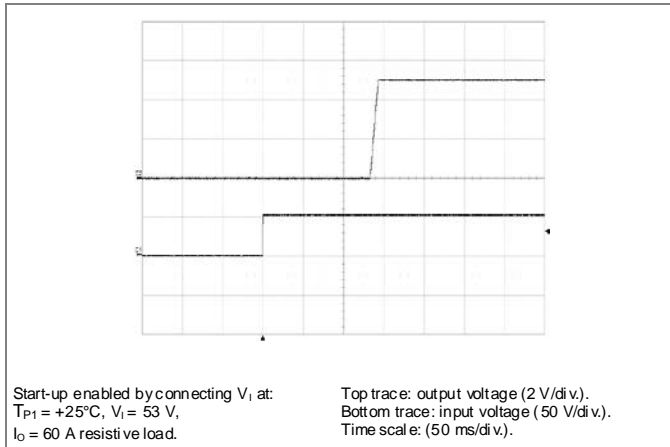

#### Shut-down

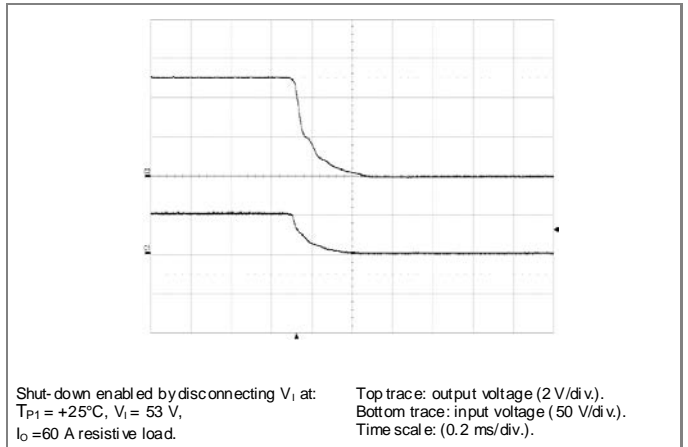

#### Output Ripple & Noise

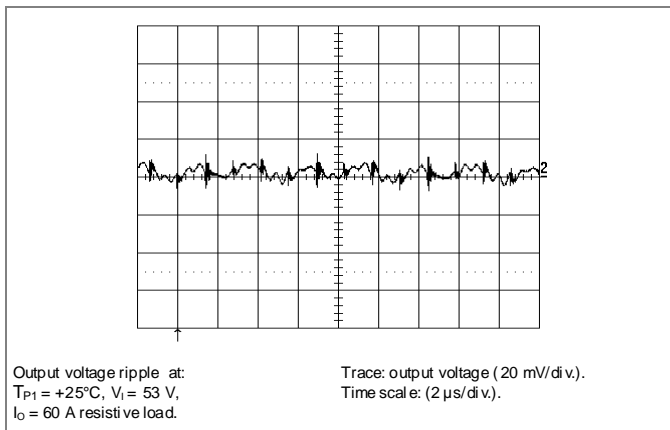

#### Output Load Transient Response

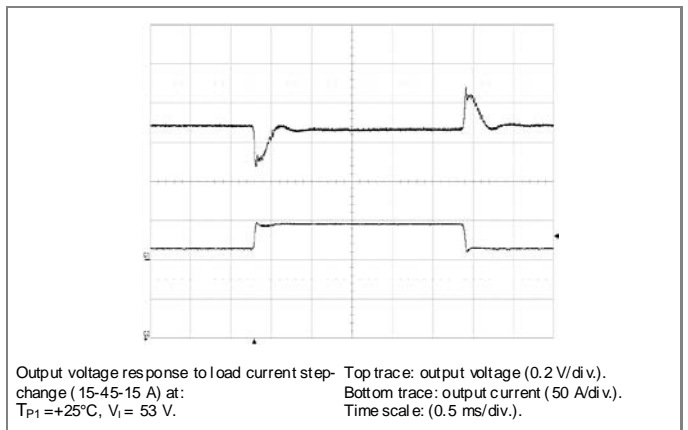

**BMR45' series Fully regulated Advanced Bus Converters**  
 Input 36-75 V, Output up to 60 A / 396 W

EN/LZT 146 395 R10A September 2017

© Flex

**9.0V, 33A / 297W Electrical Specification**
**BMR 453 0000/002**
 $T_{P1} = -40$  to  $+90^{\circ}\text{C}$ ,  $V_I = 36$  to  $75$  V, sense pins connected to output pins unless otherwise specified under Conditions.

 Typical values given at:  $T_{P1} = +25^{\circ}\text{C}$ ,  $V_I = 53$  V,  $I_O = \text{max}$ , unless otherwise specified under Conditions.

 Additional  $C_{out} = 0.1$  mF, Configuration File: 190 10-CDA 102 935/002 rev D

Characteristics		Conditions	min	typ	max	Unit
$V_I$	Input voltage range		36		75	V
$V_{loff}$	Turn-off input voltage	Decreasing input voltage	32	33	34	V
$V_{lon}$	Turn-on input voltage	Increasing input voltage	34	35	36	V
$C_i$	Internal input capacitance			18		$\mu\text{F}$
$P_O$	Output power		0		297	W
$\eta$	Efficiency	50% of $I_O$		96		%
		$I_O$		95		
		50% of $I_O$ , $V_I = 48$ V		96		
		$I_O$ , $V_I = 48$ V		95		
$P_d$	Power Dissipation	$I_O$		15.5	24.7	W
$P_{li}$	Input idling power	$I_O = 0$ A, $V_I = 53$ V		2.1		W
$P_{RC}$	Input standby power	$V_I = 53$ V (turned off with RC)		190		mW
$f_s$	Default switching frequency	0-100% of $I_O$ see Note 1	133	140	145	kHz

$V_{\alpha}$	Output voltage initial setting and accuracy	$T_{P1} = +25^{\circ}\text{C}$ , $V_I = 53$ V, $I_O = 17$ A	8.90	9.0	9.10	V
$V_O$	Output adjust range	See operating information	8.1		13.2	V
	Output voltage tolerance band	0-100% of $I_O$	8.82		9.18	V
	Line regulation	$I_O$		15	50	mV
	Load regulation	$V_I = 53$ V, 1-100% of $I_O$		60	85	mV
$V_{tr}$	Load transient voltage deviation	$V_I = 53$ V, Load step 25-75-25% of $I_O$ , $di/dt = 1$ A/ $\mu\text{s}$ , see Note 2		$\pm 0.35$		V
$t_{tr}$	Load transient recovery time			250		$\mu\text{s}$
$t_r$	Ramp-up time (from 10-90% of $V_O$ )	10-100% of $I_O$ , $T_{P1} = 25^{\circ}\text{C}$ , $V_I = 53$ V		8		ms
$t_s$	Start-up time (from $V_I$ connection to 90% of $V_O$ )	see Note 3		140		ms
$t_f$	Vin shutdown fall time (from $V_I$ off to 10% of $V_O$ )	$I_O$		0.4		ms
		$I_O = 0$ A		8		s
$t_{RC}$	RC start-up time	$I_O$		53		ms
		$I_O$		3.2		ms
		$I_O = 0$ A		8		s
$I_O$	Output current		0		33	A
$I_{lim}$	Current limit threshold	$V_O = 8.1$ V, $T_{P1} < \text{max } T_{P1}$	34	38	43	A
$I_{sc}$	Short circuit current	$T_{P1} = 25^{\circ}\text{C}$ , $V_O < 0.2$ V, see Note 4		6		A
$C_{out}$	Recommended Capacitive Load	$T_{P1} = 25^{\circ}\text{C}$ , see Note 5	0.1	3.3	6	mF
$V_{Oac}$	Output ripple & noise	See ripple & noise section, $I_O$ , $V_{\alpha}$		50	120	mVp-p
OVP	Over voltage protection	$T_{P1} = +25^{\circ}\text{C}$ , $V_I = 53$ V, 10-100% of $I_O$ , see Note 6		15.6		V

Note 1: Frequency may be adjusted via PMBus, see Operating Information section.

 Note 2:  $C_{out} = 3.3$  mF used at load transient test.

Note 3: Start-up and Ramp-up time can be increased via PMBus, see Operation Information section.

Note 4: RMS current in hiccup mode.

Note 5: Low ESR-value.

Note 6: OVP-level can be adjusted via PMBus, see Operation Information.

**BMR45' series** Fully regulated Advanced Bus Converters  
 Input 36-75 V, Output up to 60 A / 396 W

EN/LZT 146 395 R10A September 2017

© Flex

### 9.0V, 33A / 297W Electrical Specification

**BMR 453 0000/002**

#### Efficiency

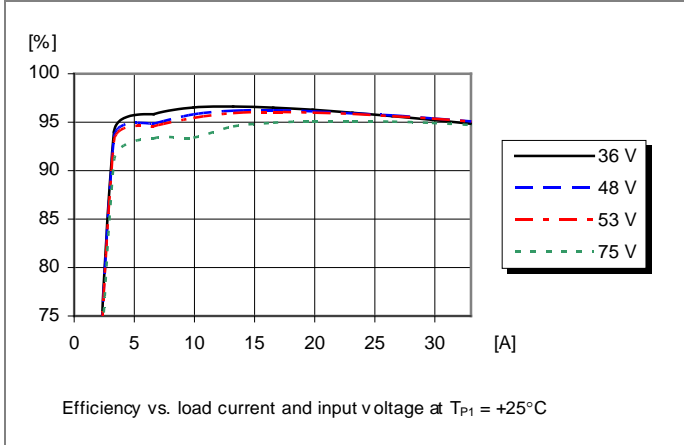

#### Power Dissipation

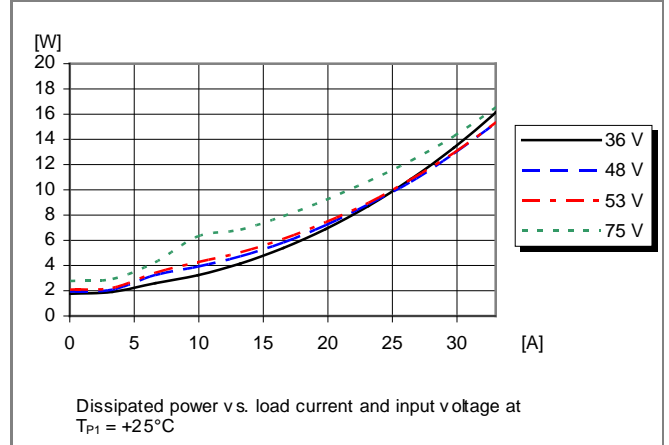

#### Output Current Derating, open frame

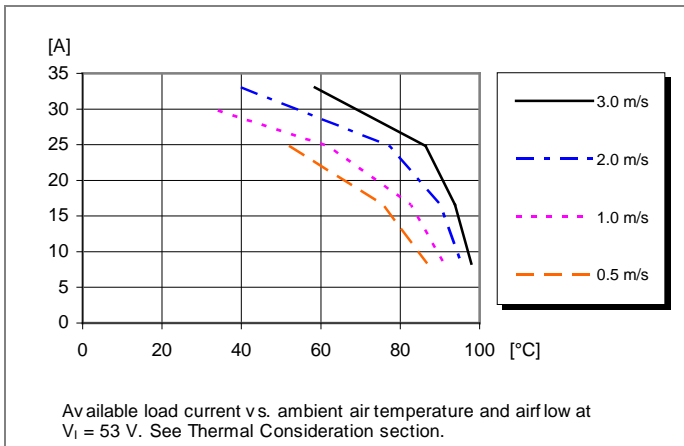

#### Output Current Derating, base plate option

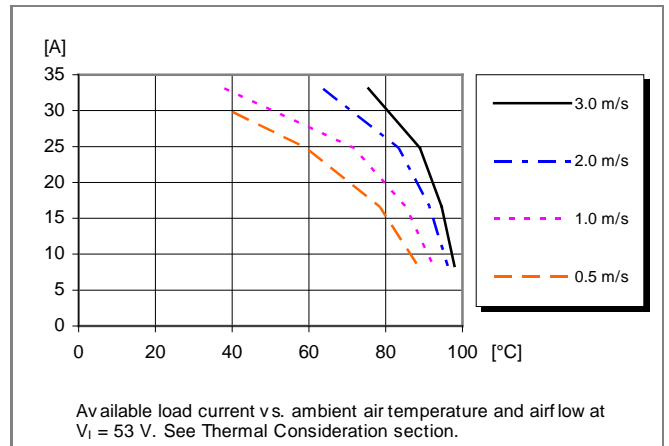

#### Thermal Resistance, base plate option

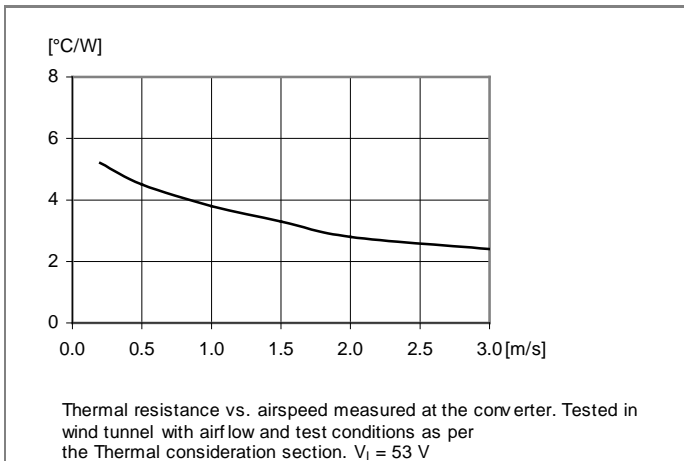

**BMR45' series** Fully regulated Advanced Bus Converters  
 Input 36-75 V, Output up to 60 A / 396 W

EN/LZT 146 395 R10A September 2017

© Flex

### 9.0V, 33A / 297W Electrical Specification

**BMR 453 0000/002**

#### Output Characteristics

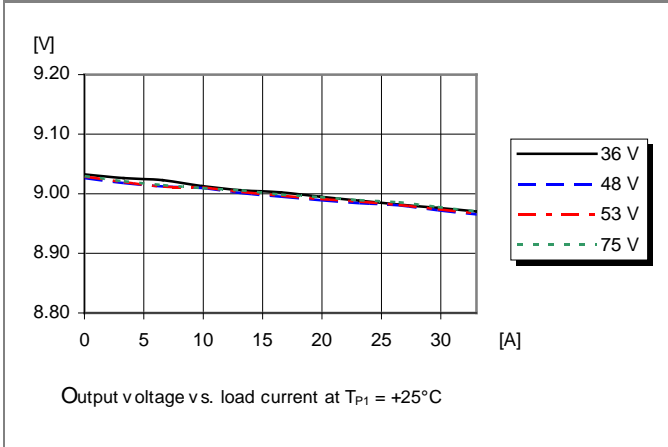

#### Current Limit Characteristics

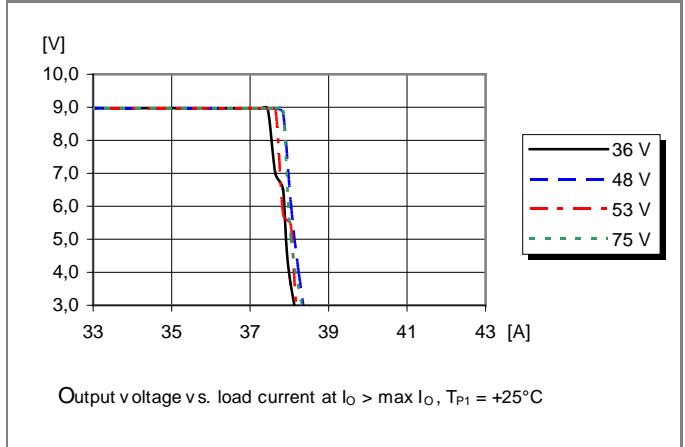

#### Start-up

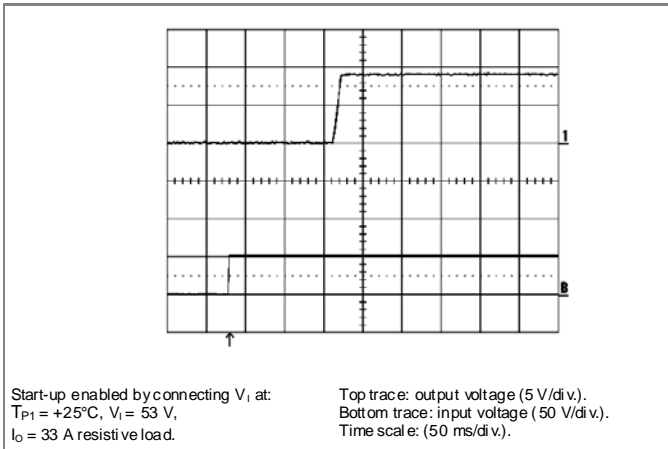

#### Shut-down

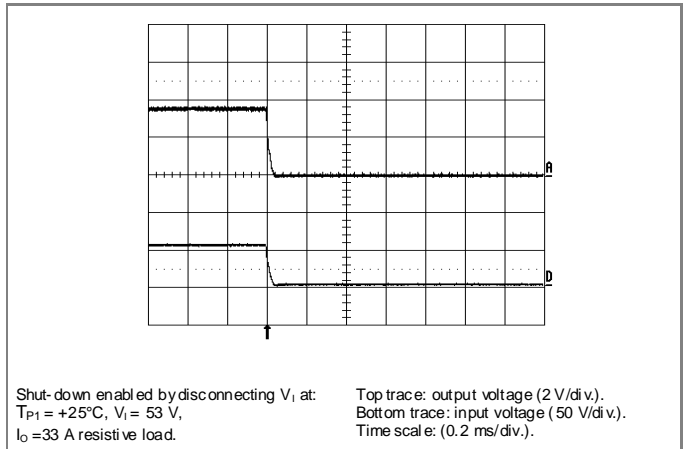

#### Output Ripple & Noise

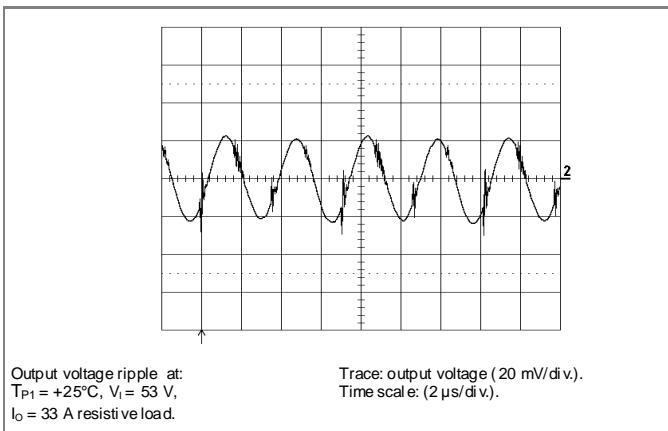

#### Output Load Transient Response

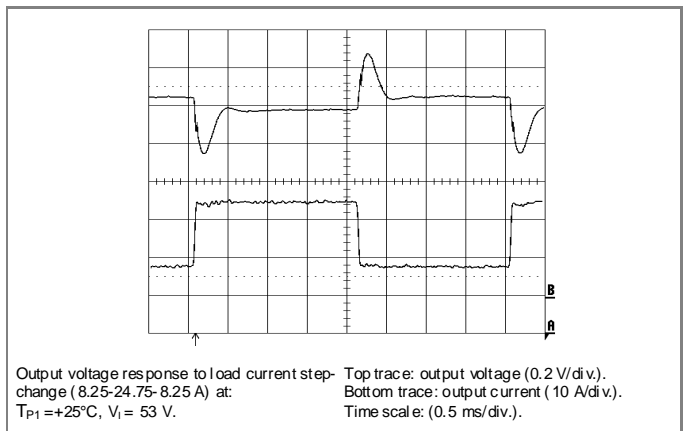

**BMR45' series Fully regulated Advanced Bus Converters**  
 Input 36-75 V, Output up to 60 A / 396 W

EN/LZT 146 395 R10A September 2017

© Flex

**12.0V, 33A / 396W Electrical Specification**
**BMR 453 0000/001**
 $T_{P1} = -40$  to  $+90^{\circ}\text{C}$ ,  $V_I = 36$  to  $75$  V, sense pins connected to output pins unless otherwise specified under Conditions.

 Typical values given at:  $T_{P1} = +25^{\circ}\text{C}$ ,  $V_I = 53$  V, max  $I_O$ , unless otherwise specified under Conditions.

 Additional  $C_{out} = 0.1$  mF, Configuration File: 190 10-CDA 102 935/001 rev D

Characteristics		Conditions	min	typ	max	Unit
$V_I$	Input voltage range		36		75	V
$V_{loff}$	Turn-off input voltage	Decreasing input voltage	32	33	34	V
$V_{lon}$	Turn-on input voltage	Increasing input voltage	34	35	36	V
$C_i$	Internal input capacitance			18		$\mu\text{F}$
$P_o$	Output power		0		396	W
$\eta$	Efficiency	50% of max $I_O$		96.5		%
		max $I_O$		95.5		
		50% of max $I_O$ , $V_I = 48$ V		96.5		
		max $I_O$ , $V_I = 48$ V		95.5		
$P_d$	Power Dissipation	max $I_O$		18.3	27.1	W
$P_i$	Input idling power	$I_O = 0$ A, $V_I = 53$ V		2.4		W
$P_{RC}$	Input standby power	$V_I = 53$ V (turned off with RC)		190		mW
$f_s$	Default switching frequency	0-100% of max $I_O$ see Note 1	133	140	145	kHz

$V_{O1}$	Output voltage initial setting and accuracy	$T_{P1} = +25^{\circ}\text{C}$ , $V_I = 53$ V, $I_O = 17$ A	11.88	12.0	12.12	V
$V_O$	Output adjust range	See operating information	8.1		13.2	V
	Output voltage tolerance band	0-100% of max $I_O$	11.76		12.24	V
	Line regulation	max $I_O$ at 40-75V input, see Note 7		20	60	mV
	Load regulation	$V_I = 53$ V, 1-100% of max $I_O$		60	90	mV
$V_{tr}$	Load transient voltage deviation	$V_I = 53$ V, Load step 25-75-25 % of max $I_O$ , $di/dt = 1$ A/ $\mu\text{s}$ , see Note 2		$\pm 0.4$		V
$t_{tr}$	Load transient recovery time			250		$\mu\text{s}$
$t_r$	Ramp-up time (from 10-90% of $V_{O1}$ )	10-100% of max $I_O$ , $T_{P1} = 25^{\circ}\text{C}$ , $V_I = 53$ V		8		ms
$t_s$	Start-up time (from $V_I$ connection to 90% of $V_{O1}$ )	see Note 3		140		ms
$t_f$	$V_{in}$ shutdown fall time (from $V_I$ off to 10% of $V_O$ )	max $I_O$		0.4		ms
		$I_O = 0$ A		7		s
$t_{RC}$	RC start-up time	max $I_O$		53		ms
	RC shutdown fall time (from RC off to 10% of $V_O$ )	max $I_O$		3.2		ms
		$I_O = 0$ A		7		s
$I_O$	Output current		0		33	A
$I_{lim}$	Current limit threshold	$V_O = 10.8$ V, $T_{P1} < \max T_{ref}$	34	38	43	A
$I_{sc}$	Short circuit current	$T_{P1} = 25^{\circ}\text{C}$ , see Note 4		-		A
$C_{out}$	Recommended Capacitive Load	$T_{P1} = 25^{\circ}\text{C}$ , see Note 5	0.1	3.3	6	mF
$V_{Oac}$	Output ripple & noise	See ripple & noise section, max $I_O$		60	120	mVp-p
OVP	Over voltage protection	$T_{P1} = +25^{\circ}\text{C}$ , $V_I = 53$ V, 10-100% of max $I_O$ , see Note 6		15.6		V

Note 1: Frequency may be adjusted with PMBus communication. See Operating Information section

 Note 2:  $C_{out} = 3.3$  mF used at load transient test.

Note 3: Start-up and Ramp-up time can be increased via PMBus, see Operation Information section.

Note 4: OCP in latch mode

Note 5: Low ESR-value

Note 6: OVP-level can be adjusted via PMBus, see Operation Information.

Note 7: Line regulation characteristics at 36 to 75V input are presented on the next page.



**BMR45' series** Fully regulated Advanced Bus Converters  
 Input 36-75 V, Output up to 60 A / 396 W

EN/LZT 146 395 R10A September 2017

© Flex

### 12.0V, 33A / 396W Electrical Specification

**BMR 453 0000/001**

#### Efficiency

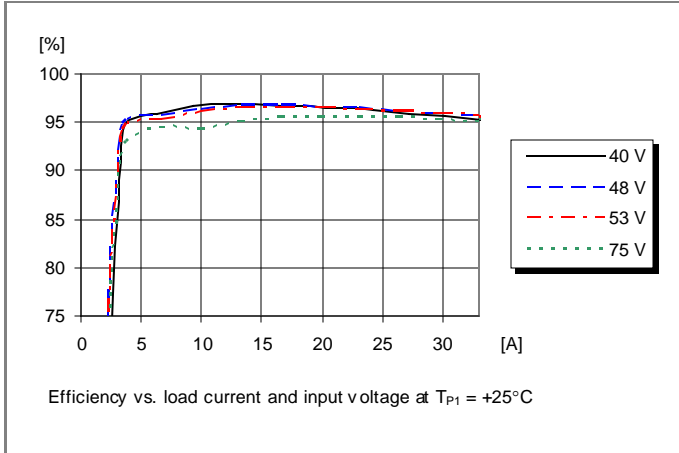

#### Power dissipation

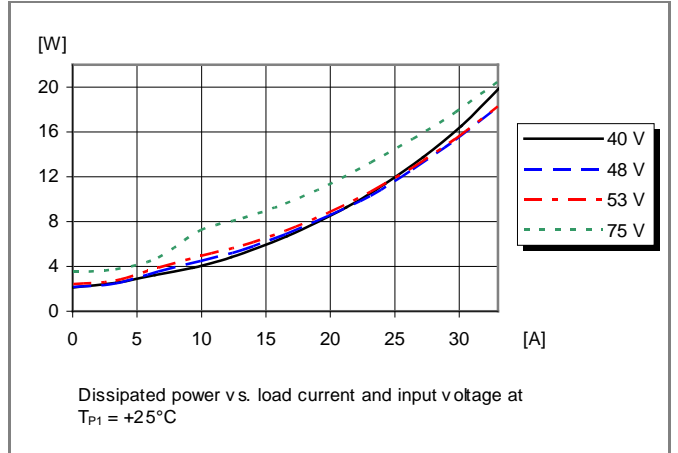

#### Output Current Derating, open frame

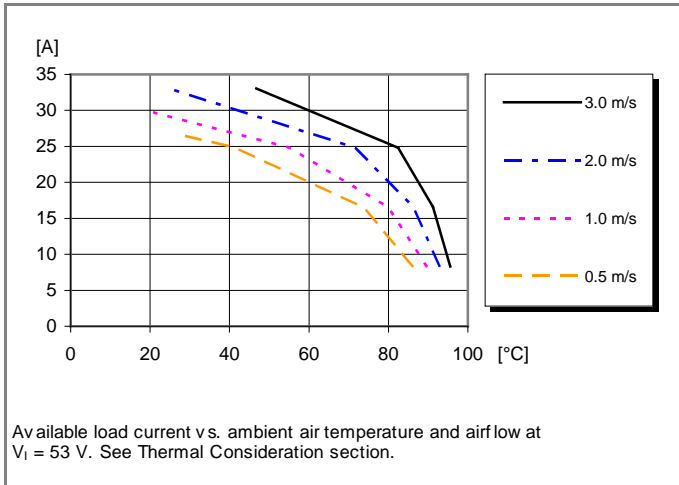

#### Output Current Derating, base plate option

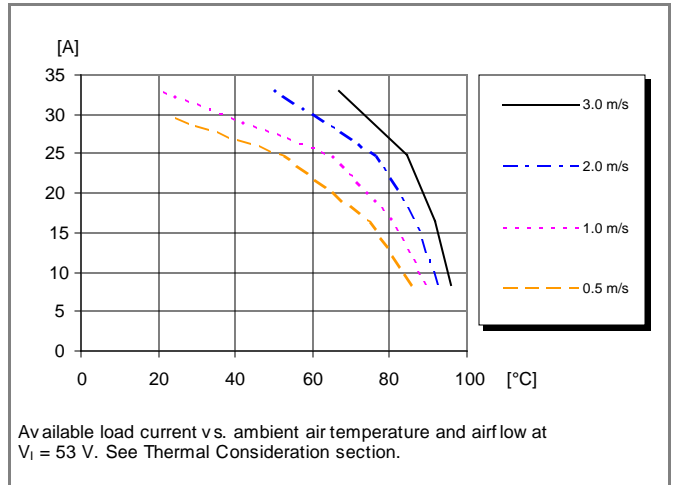

#### Thermal Resistance, base plate option

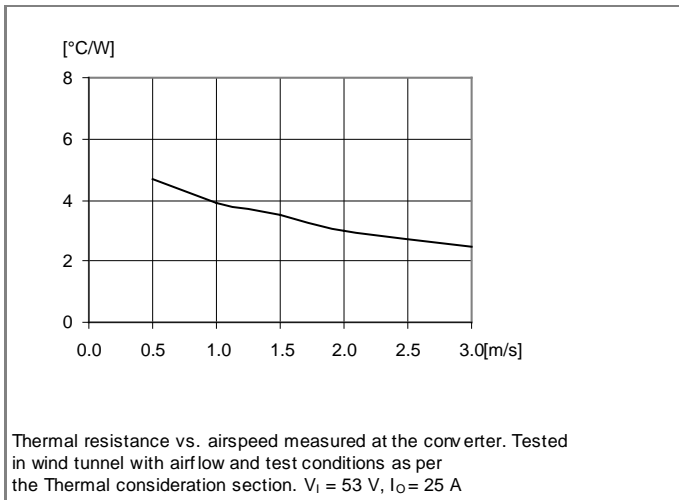

**BMR45' series** Fully regulated Advanced Bus Converters  
 Input 36-75 V, Output up to 60 A / 396 W

EN/LZT 146 395 R10A September 2017

© Flex

### 12.0V, 33A / 396W Electrical Specification

**BMR 453 0000/001**

#### Output Characteristics

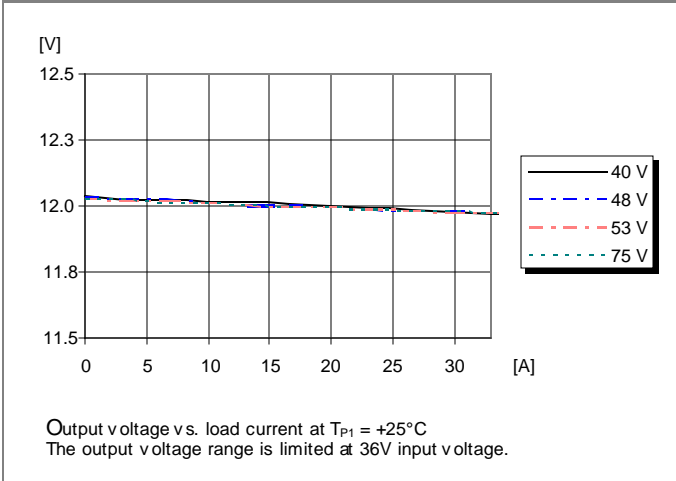

#### Current Limit Characteristics

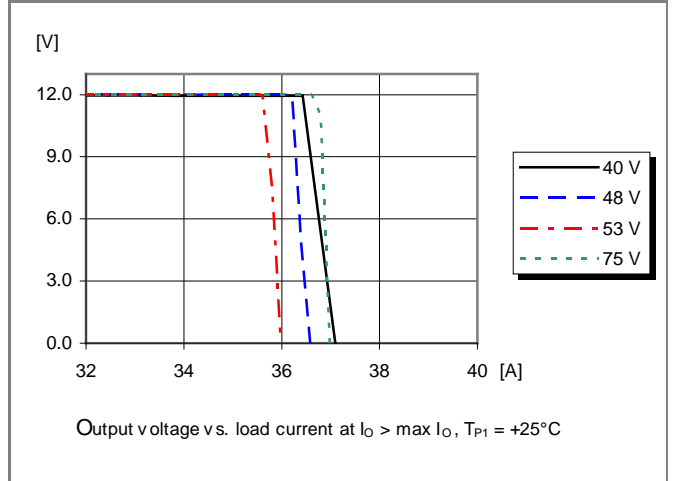

#### Start-up

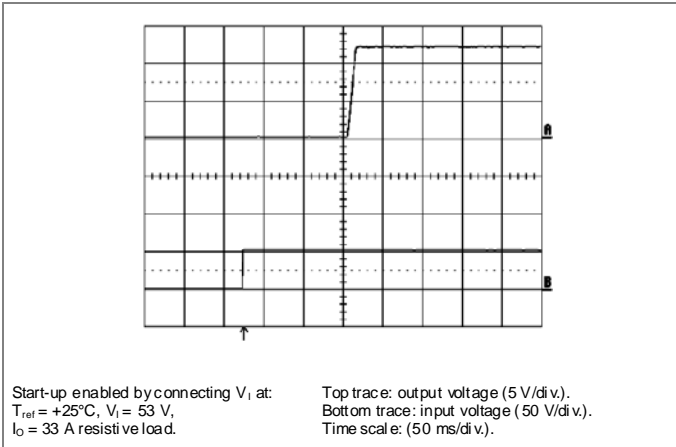

#### Shut-down

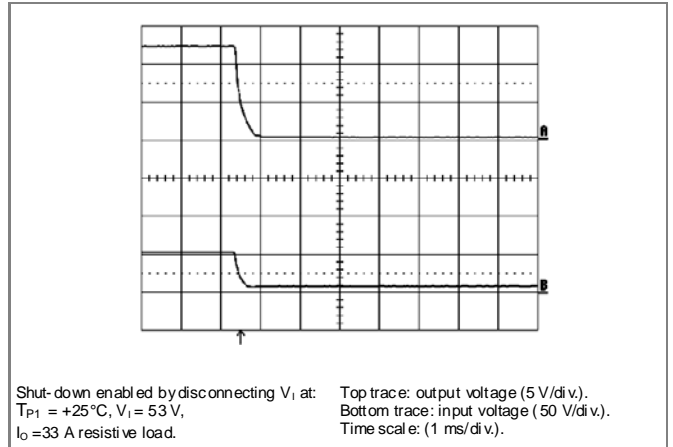

#### Output Ripple & Noise

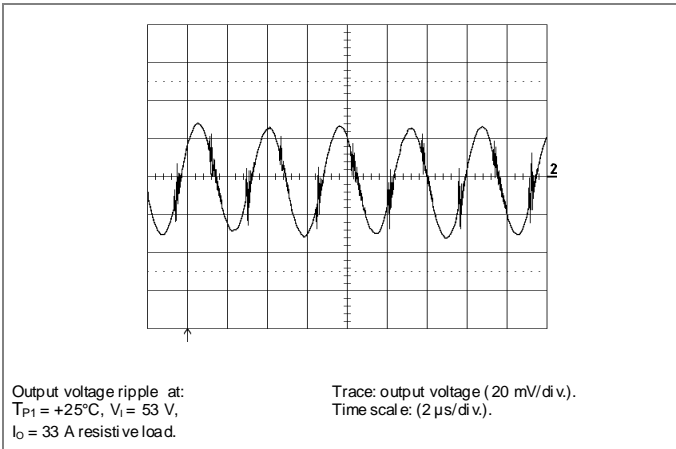

#### Output Load Transient Response

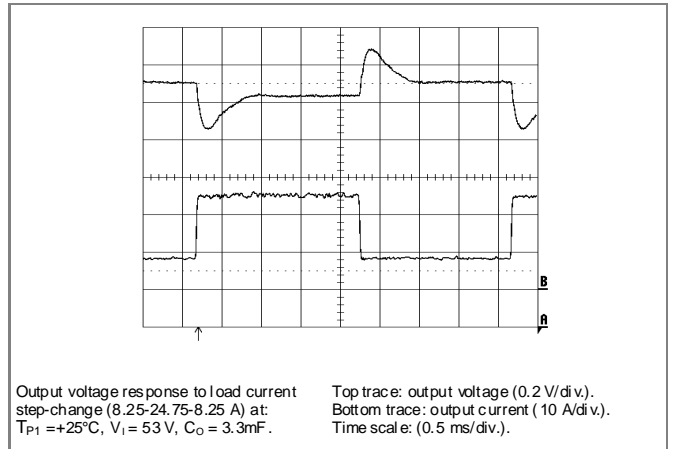

**BMR45' series** Fully regulated Advanced Bus Converters  
 Input 36-75 V, Output up to 60 A / 396 W

EN/LZT 146 395 R10A September 2017

© Flex

### EMC Specification

Conducted EMI measured according to EN55022, CISPR 22 and FCC part 15J (see test set-up). See Design Note 009 for further information. The fundamental switching frequency is 140 kHz for BMR 453 @  $V_I = 53$  V, max  $I_O$ .

#### Conducted EMI Input terminal value (typ)

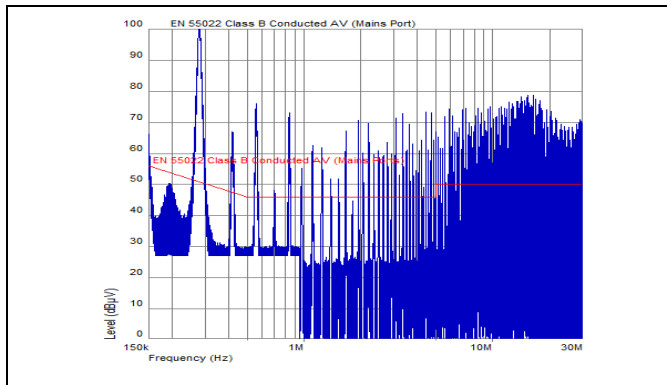

EMI without filter

#### External filter (class B)

Suggested external input filter in order to meet class B in EN 55022, CISPR 22 and FCC part 15J.

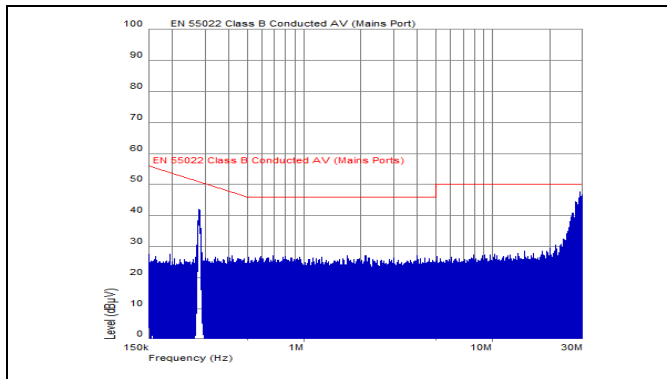
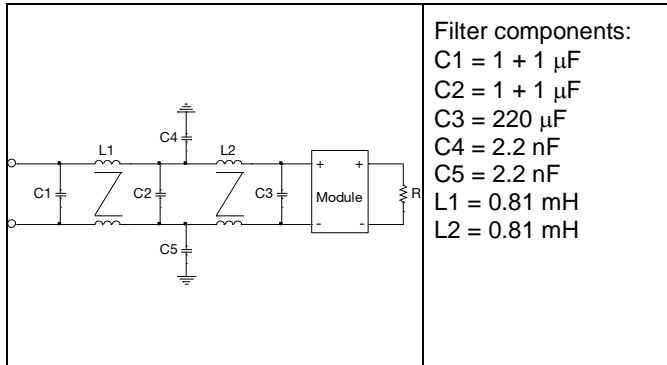

EMI with filter

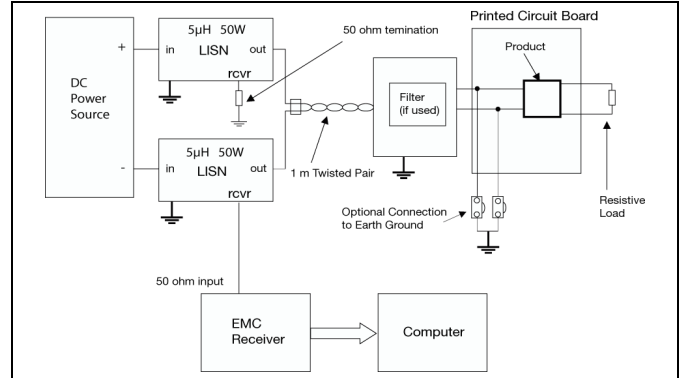

Test set-up

#### Layout recommendation

The radiated EMI performance of the product will depend on the PWB layout and ground layer design. It is also important to consider the stand-off of the product. If a ground layer is used, it should be connected to one of the output terminals and the equipment ground or chassis.

A ground layer will increase the stray capacitance in the PWB and improve the high frequency EMC performance.

#### Output ripple and noise

Output ripple and noise measured according to figure below. See Design Note 022 for detailed information.

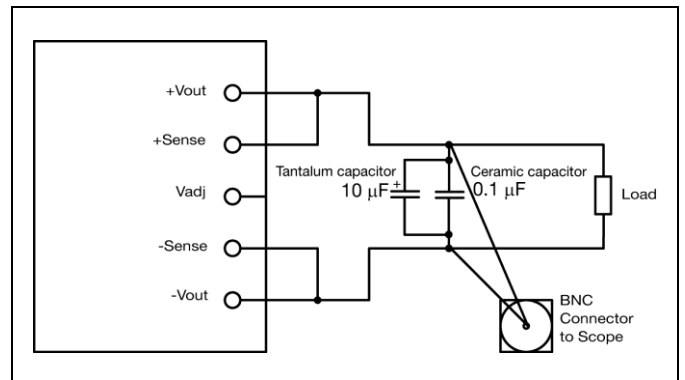

Output ripple and noise test setup

**BMR45' series Fully regulated Advanced Bus Converters**  
 Input 36-75 V, Output up to 60 A / 396 W

EN/LZT 146 395 R10A September 2017

© Flex

### Operating information

#### Input Voltage

The input voltage range 36 to 75 Vdc meets the requirements of the European Telecom Standard ETS 300 132-2 for normal input voltage range in -48 and -60 Vdc systems, -40.5 to -57.0 V and -50.0 to -72 V respectively. At input voltages exceeding 75 V, the power loss will be higher than at normal input voltage and  $T_{P1}$  must be limited to absolute max +125°C. The absolute maximum continuous input voltage is 80 Vdc.

#### Turn-off Input Voltage

The product monitors the input voltage and will turn on and turn off at predetermined levels. The turn on and turn off level and the hysteresis in between can be configured via the PMBus. The default hysteresis between turn on and turn off input voltage is set to 2 V.

#### Remote Control (RC)

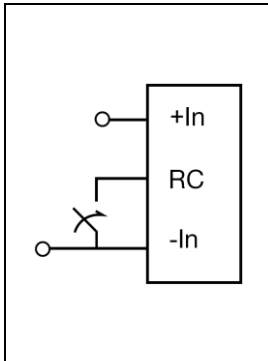

The products are fitted with a configurable remote control function. The primary remote control is referenced to the primary negative input connection (-In). The RC function allows the converter to be turned on/off by an external device like a semiconductor or mechanical switch. The RC pin has an internal pull up resistor. The remote control functions can also be configured using the PMBus.

The device should be capable of sinking 0.7 mA. When the RC pin is left open, the voltage generated on the RC pin is max 6 V. The standard product is provided with "negative logic" remote control and will be off until the RC pin is connected to the -In. To turn on the product the voltage between RC pin and -In should be less than 1 V. To turn off the product the RC pin should be left open. In situations where it is desired to have the product to power up automatically without the need for control signals or a switch, the RC pin can be wired directly to -In. The logic option for the primary remote control is configured using the PMBus.

#### Remote Control (secondary side)

The CTRL CS pin can be configured as remote control via the PMBus interface. In the default configuration the CTRL CS pin is disabled and the output has an internal pull-up to 3.3 V. The CTRL CS pin can be left open when not used. The logic options for the secondary remote control can be positive or negative logic.

#### Input and Output Impedance

The impedance of both the input source and the load will interact with the impedance of the product. It is important that the input source has low characteristic impedance. Minimum

recommended external input capacitance is 100 uF. The performance in some applications can be enhanced by addition of external capacitance as described under External Decoupling Capacitors.

#### External Decoupling Capacitors

When powering loads with significant dynamic current requirements, the voltage regulation at the point of load can be improved by addition of decoupling capacitors at the load. The recommended minimum capacitance on the output is 100 uF. The most effective technique is to locate low ESR ceramic and electrolytic capacitors as close to the load as possible, using several parallel capacitors to lower the effective ESR. The ceramic capacitors will handle high-frequency dynamic load changes while the electrolytic capacitors are used to handle low frequency dynamic load changes. Ceramic capacitors will also reduce any high frequency noise across the load. It is equally important to use low resistance and low inductance PWB layouts and cabling.

External decoupling capacitors will become part of the product's control loop. The control loop is optimized for a wide range of external capacitance and the maximum recommended value that could be used without any additional analysis is found in the Electrical specification.

The ESR of the capacitors is a very important parameter. Stable operation is guaranteed with a verified ESR value of  $>10 \text{ m}\Omega$  across the output connections.

For further information please contact your local Flex Power Modules representative.

#### PMBus configuration and support

The products provide a PMBus digital interface that enables the user to configure many aspects of the device operation as well as monitor the input and output parameters. Please contact your local Flex Power Modules representative for appropriate SW tools to down-load new configurations.

#### Output Voltage Adjust using PMBus

The output voltage of the product can be reconfigured using the PMBus interface. BMR 453 xx00/001 and /002 can be adjusted from 8.1 V to 13.2 V. The BMR 453 xx02/003 and /004 can be adjusted from 3.0 V to 6.7 V.

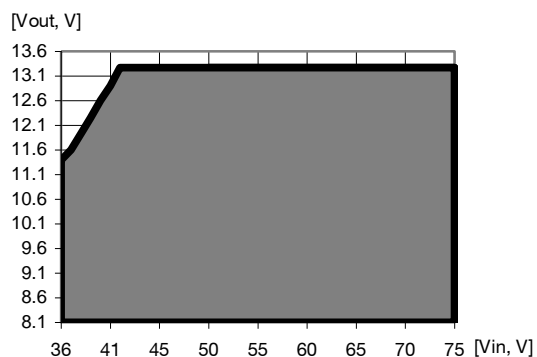

The output voltage will be fully regulated for all operating combinations within the shaded area in the plot above.

**BMR45' series Fully regulated Advanced Bus Converters**  
Input 36-75 V, Output up to 60 A / 396 W

EN/LZT 146 395 R10A September 2017

© Flex

Operation outside of this area is not recommended for normal use.

### Margin Up/Down Controls

These controls allow the output voltage to be momentarily adjusted, either up or down, by a nominal 10%. This provides a convenient method for dynamically testing the operation of the load circuit over its supply margin or range. It can also be used to verify the function of supply voltage supervisors. The margin up and down levels of the product can be re-configured using the PMBus interface.

### Soft-start Power Up

The soft-start control introduces a time-delay (default setting 40 ms) before allowing the output voltage to rise. The default rise time of the ramp up is 10 ms. Power-up is hence completed within 50 ms in default configuration using remote control. When starting by applying input voltage the control circuit boot-up time adds an additional 100 ms delay. The soft-start power up of the product can be reconfigured using the PMBus interface.

### Remote Sense

The products have remote sense that can be used to compensate for voltage drops between the output and the point of load. The sense traces should be located close to the PCB ground layer to reduce noise susceptibility. The remote sense circuitry will compensate for up to 10% voltage drop between +Out pin and the point of load (+Sense). The -Sense pin should be always connected to -Out. When activating remote sense, connect the +Sense pin to the +Input of the load. If the remote sense is not needed +Sense pin should be connected to +Out of the BMR453 unit. To be able to use remote sense the converter must be equipped with a digital connector.

### Temperature Protection (OTP, UTP)

The products are protected from thermal overload by an internal temperature shutdown protection.

When  $T_{P1}$  as defined in thermal consideration section is exceeded the product will shut down. The product will make continuous attempts to start up (non-latching mode) and resume normal operation automatically when the temperature has dropped below the temperature threshold, the hysteresis is defined in general electrical specification.

The OTP and hysteresis of the product can be re-configured using the PMBus interface. The product has also an under temperature protection. The OTP and UTP fault limit and fault response can be configured via the PMBus. Note: using the fault response "continue without interruption" may cause permanent damage of the product.

### Over Voltage Protection (OVP)

The product has output over voltage protection that will shut down the converter in over voltage conditions (latching mode) The OVP fault level and fault response can be re-configured using the PMBus interface.

### Over Current Protection (OCP)

The product includes current limiting circuitry for protection at continuous overload. The module needs RC cycle operation at least once before enters hiccup mode if the maximum output current is exceeded and the output voltage is below  $0.3 \times V_{out}$ . The load distribution should be designed for the maximum output short circuit current specified. If for some reason the output should be short circuited, minimum resistance should not be lower than 6 m $\Omega$ . The OCP level and fault response can be re-configured using the PMBus interface. The default configuration is set to hiccup mode for the OCP, except for BMR453xxx/001 (latching OCP). Brick wall OCP mode is also supported in BMR453 series for option. For further information please contact your local Flex Power Modules representative. RC recycle operation as below:

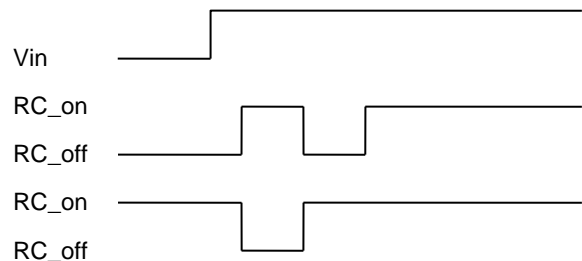

### Input Over/Under voltage protection

The input of the product can be protected against high input voltage and low input voltage. The over- and under-voltage fault level and fault response can be configured via the PMBus interface.

### Pre-bias Start-up

The product has a Pre-bias start up functionality and will not sink current during start up if a pre-bias source is present at the output terminals.

### Power Good

The PG SYNC pin can be configured as an output (POWER GOOD). The power good signal (TTL level) indicates proper operation of the product and can also be used as an error flag indicator. The PG SYNC pin has POWER GOOD as default configuration with the output set as active low. The PG SYNC pin is configured via the PMBus interface.

### Tracking and External reference

The PG SYNC pin can be configured as an input for voltage tracking or an external analogue reference.

The PG SYNC pin is configured via the PMBus interface and has default setting Power Good. Send command MFR\_MULTI\_PIN\_CONFIG (0xF9h) with data 0x10h, the module will work in standalone tracking mode; Connect the PG\_SYNC pin to the external reference voltage (ground to -OUT), the output voltage will follow this reference voltage with a predefined scale.

The max reference voltage is 2.5 V which connects to digital controller's ADC port.

The reference voltage /  $V_{out}$  scale factor is stored in MFR\_VOUT\_ANALOG\_SCALE (0xE8h) with default value

**BMR45' series Fully regulated Advanced Bus Converters**  
 Input 36-75 V, Output up to 60 A / 396 W

EN/LZT 146 395 R10A September 2017

© Flex

0.175(0xA2CDh), end user can change it by using PMBus command.

End user can read the scaled value by command MFR\_READ\_VOUT\_ANALOG\_REF (0xE9h). Any changes of using PMBUS command should use command Store Default all (0x11h) to make the change permanent before power off.

**Switching frequency adjust using PMBus**

The switching frequency is set to 140 kHz as default but this can be reconfigured via the PMBus interface. The product is optimized at this frequency but can run at lower and higher frequency, (125 kHz – 150 kHz). However the output performance is not specified if the frequency is changed.

**Input Transient**

The BMR453 products have limited ability to react on sudden input voltage changes. As an example the 12 V module BMR453xxxx/001 can have an output voltage deviation of 5 V when a 20 V input step is applied (40 V to 60 V). This is tested with a slew rate of 0.1 V/us on the input voltage change and minimum output capacitance 100 uF. Increasing the output capacitance will improve the result.

**Parallel Operation with Droop**

The BMR 453 0006(or BMR4530007) with /012 or /013 or /014 configuration file are variants that can be connected in parallel. The products have a pre-configured voltage droop: The stated output voltage initial setting accuracy is within ±35mV at no load, The output voltage will decrease when the load current is increased, the voltage will droop 0.6V while load reaches max load. This feature allows the products to be connected in parallel and share the current with 10% accuracy. Up to 90% of max output current can be used from each module.

Parallel Operation with Droop

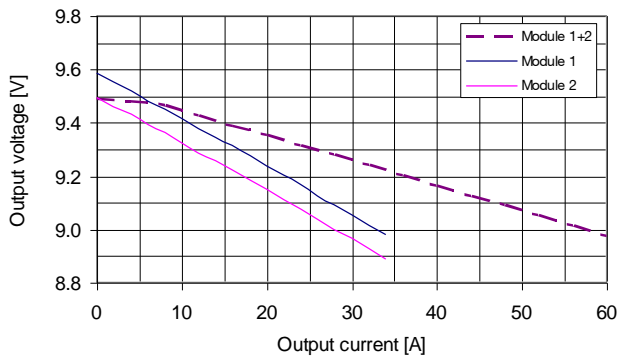

**Fault protection at parallel operation with Droop**

If one of the two modules exceeds the OVP, OCP or OTP level, the module might turn off depends on its pre-set fault response action, and the other module might not handle more current than its max capability, that will lead to both modules can not recover until the protection trig condition removed, to secure a normal operation, both modules need a reset.

**Typical V<sub>out</sub> Vs. V<sub>in</sub> characteristic at 33A load and TP1=25°C**

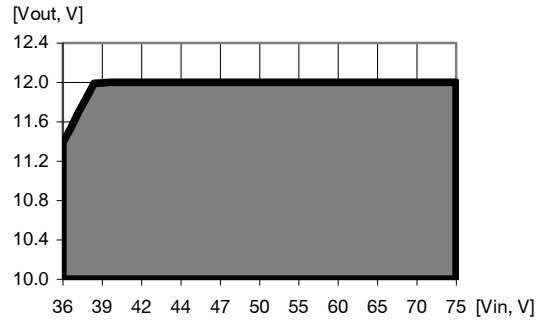

The output voltage will be fully regulated for all operating combinations within the shaded area in the plot above. Operation outside of this area is not recommended for normal use.

**BMR45' series** Fully regulated Advanced Bus Converters  
 Input 36-75 V, Output up to 60 A / 396 W

EN/LZT 146 395 R10A September 2017

© Flex

### Thermal Consideration

#### General

The products are designed to operate in different thermal environments and sufficient cooling must be provided to ensure reliable operation. For products mounted on a PWB without a heat sink attached, cooling is achieved mainly by conduction, from the pins to the host board, and convection, which is dependant on the airflow across the product. Increased airflow enhances the cooling of the product. The Output Current Derating graph found in the Output section for each model provides the available output current vs. ambient air temperature and air velocity at  $V_I = 53 V$ .

The product is tested on a 254 x 254 mm, 35  $\mu m$  (1 oz), 8-layer test board mounted vertically in a wind tunnel with a cross-section of 608 x 203 mm.

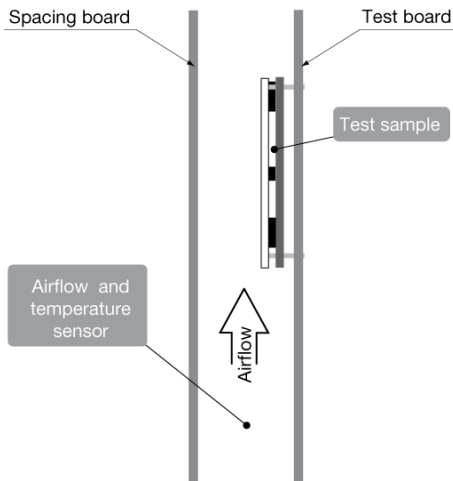

#### Definition of product operating temperature

The product operating temperatures is used to monitor the temperature of the product, and proper thermal conditions can be verified by measuring the temperature at positions P1, P2, P3, P4. The temperature at these positions ( $T_{P1}$ ,  $T_{P2}$ ,  $T_{P3}$ ,  $T_{P4}$ ) should not exceed the maximum temperatures in the table below. The number of measurement points may vary with different thermal design and topology. Temperatures above maximum  $T_{P1}$ , measured at the reference point P1 (P3 for base plate versions) are not allowed and may cause permanent damage.

Position	Description	Max temperature
P1	PWB (reference point)	$T_{P1} = 125^\circ C$
P2	Opto-coupler	$T_{P2} = 105^\circ C$
P3	PWB (reference point for base-plate version)	$T_{P3} = 125^\circ C$
P4	Primary MOSFET	$T_{P4} = 125^\circ C$

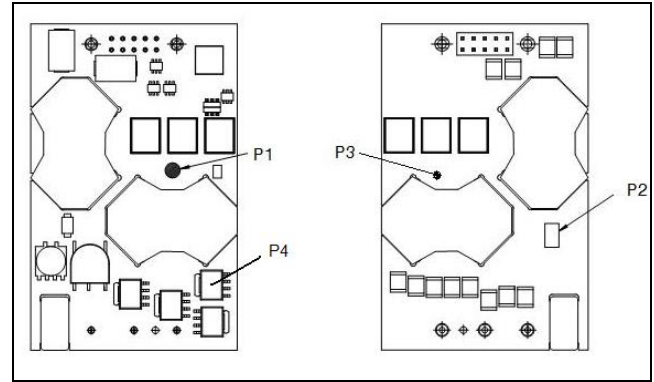

Top view  
 (Best airflow direction  
 Negative to Positive.)

Bottom view  
 (base plate version)

#### Ambient Temperature Calculation

For products with base plate the maximum allowed ambient temperature can be calculated by using the thermal resistance.

1. The power loss is calculated by using the formula  $((1/\eta) - 1) \times \text{output power} = \text{power losses (Pd)}$ .  
 $\eta = \text{efficiency of product}$ . E.g. 95% = 0.95

2. Find the thermal resistance ( $R_{th}$ ) in the Thermal Resistance graph found in the Output section for each model. **Note that the thermal resistance can be significantly reduced if a heat sink is mounted on the top of the base plate.**

Calculate the temperature increase ( $\Delta T$ ).  
 $\Delta T = R_{th} \times P_d$

3. Max allowed ambient temperature is:  
 Max  $T_{P1} - \Delta T$ .

E.g. BMR 453 5100/001 at 2 m/s:

1.  $((\frac{1}{0.944}) - 1) \times 396 W = 23.5 W$

2.  $23.5 W \times 3.1^\circ C/W = 73^\circ C$

3.  $125^\circ C - 73^\circ C = \text{max ambient temperature is } 52^\circ C$

The actual temperature will be dependent on several factors such as the PWB size, number of layers and direction of airflow.

**BMR45' series** Fully regulated Advanced Bus Converters  
 Input 36-75 V, Output up to 60 A / 396 W

EN/LZT 146 395 R10A September 2017

© Flex

### Connections (Top view)

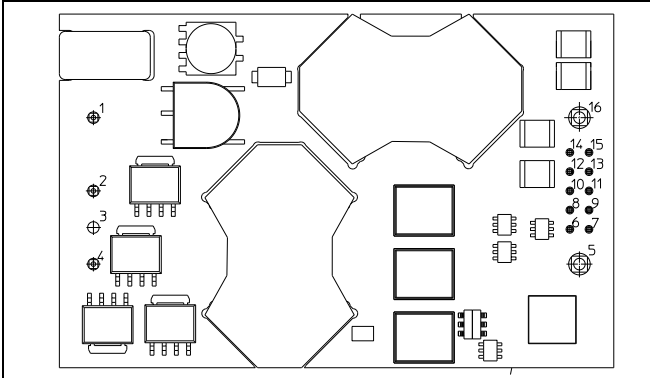

Pin	Designation	Function
1	+In	Positive Input
2	RC	Remote Control
3	Case	Case to GND (optional)
4	-In	Negative Input
5	-Out	Negative Output
6	S+	Positive Remote Sense
7	S-	Negative Remote Sense
8	SA0	Address pin 0
9	SA1	Address pin 1
10	SCL	PMBus Clock
11	SDA	PMBus Data
12	PG SYNC	Configurable I/O pin: Power Good output, SYNC-, tracking-, or ext ref-input
13	DGND	PMBus ground
14	SALERT	PMBus alert signal
15	CTRL CS	PMBus remote control or Current share
16	+Out	Positive Output



**BMR45' series** Fully regulated Advanced Bus Converters  
Input 36-75 V, Output up to 60 A / 396 W

EN/LZT 146 395 R10A September 2017

© Flex

### PMBus Communications

The products provide a PMBus digital interface that enables the user to configure many aspects of the device operation as well as monitor the input and output parameters. The products can be used with any standard two-wire I<sup>2</sup>C or SMBus host device. In addition, the device is compatible with PMBus version 1.1 and includes an SALERT line to help mitigate bandwidth limitations related to continuous fault monitoring.

### Monitoring via PMBus

A system controller can monitor a wide variety of different parameters through the PMBus interface. The controller can monitor for fault condition by monitoring the SALERT pin, which will be asserted when any number of pre-configured fault or warning conditions occur. The system controller can also continuously monitor for any number of power conversion parameters including but not limited to the following:

- Input voltage
- Output voltage
- Output current
- Internal junction temperature
- Switching frequency
- Duty cycle

### Evaluation software

A Configuration Monitoring and Management (CMM) evaluation software, is available for the products.

For more information please contact your local Flex Power Modules sales representative.

### Addressing

The figure and table below show recommended resistor values with min and max voltage range for hard-wiring PMBus addresses (series E96, 1% tolerance resistors suggested):

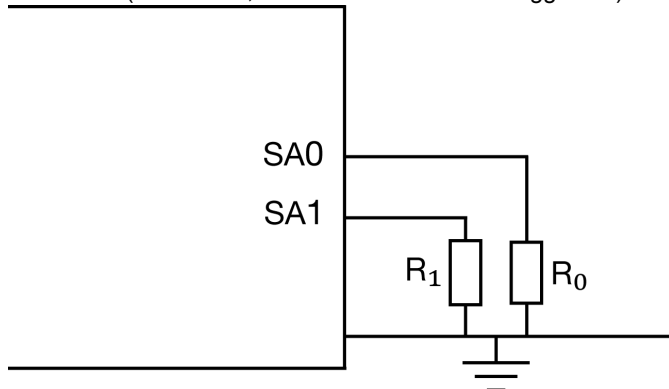

SA0/SA1	R1 /R0 [kΩ]
0	24.9
1	49.9
2	75
3	100
4	124
5	150

The SA0 and SA1 pins can be configured with a resistor to GND according to the following equation.

$$\text{PMBus Address} = 8 \times (\text{SA0value}) + (\text{SA1 value})$$

If any one of those voltage applied to ADC0 and ADC1 is out of the range from the table above, PMBus address 127 is assigned. If the calculated PMBus address is 0 or 12, PMBus address 127 is assigned instead. PMBus address 11 is not to be used. The user shall also be aware of further limitations of the addresses as stated in the PMBus Specification.

### BMR453 / BMR454 PMBus Specification Exception

Item	PMBus Standard	BMR453 /BMR454
#SMBALERT	Open Drain	Totem Pole
TLOW:EXT (Cumulative clock low extend time (slave device))	25 ms	6.25 ms
TBUF_min (Bus free time between Stop and Start Condition)	4.7 us	200 us

**BMR45' series Fully regulated Advanced Bus Converters**  
 Input 36-75 V, Output up to 60 A / 396 W

EN/LZT 146 395 R10A September 2017

© Flex

**PMBus Commands**

The DC/DC converter is PMBUS compliant. The following table lists the implemented PMBus commands. For more detailed information see PMBus Power System Management Protocol Specification; Part I – General Requirements, Transport and Electrical Interface and PMBus Power System Management Protocol; Part II – Command Language.

Designation	Cmd	Impl
<b>Standard PMBus Commands</b>		
<b>Control Commands</b>		
PAGE	00h	No
OPERATION	01h	Yes
ON_OFF_CONFIG	02h	Yes
WRITE_PROTECT	10h	Yes
<b>Output Commands</b>		
VOUT_MODE	20h	Yes
VOUT_COMMAND	21h	Yes
VOUT_TRIM	22h	Yes
VOUT_GAIN	23h	Yes <sup>note1</sup>
VOUT_MAX	24h	Yes
VOUT_MARGIN_HIGH	25h	Yes
VOUT_MARGIN_LOW	26h	Yes
VOUT_TRANSITION_RATE	27h	Yes
VOUT_DROOP	28h	No
VOUT_SCALE_LOOP	29h	Yes <sup>note1</sup>
VOUT_SCALE_MONITOR	2Ah	Yes <sup>note1</sup>
COEFFICIENTS	30h	No
POUT_MAX	31h	No
MAX_DUTY	32h	Yes
FREQUENCY_SWITCH	33h	Yes
VIN_ON	35h	Yes
VIN_OFF	36h	Yes
IOUT_CAL_GAIN	38h	Yes <sup>note1</sup>
IOUT_CAL_OFFSET	39h	Yes <sup>note1</sup>
<b>Fault Limit Commands</b>		
POWER_GOOD_ON	5Eh	Yes
POWER_GOOD_OFF	5Fh	Yes
VOUT_OV_FAULT_LIMIT	40h	Yes
VOUT_UV_FAULT_LIMIT	44h	Yes
IOUT_OC_FAULT_LIMIT	46h	Yes
IOUT_OC_LV_FAULT_LIMIT	48h	Yes
IOUT_UC_FAULT_LIMIT	4Bh	No
OT_FAULT_LIMIT	4Fh	Yes

Designation	Cmd	Impl
OT_WARN_LIMIT	51h	Yes
UT_WARN_LIMIT	52h	Yes
UT_FAULT_LIMIT	53h	Yes
VIN_OV_FAULT_LIMIT	55h	Yes
VIN_OV_WARN_LIMIT	57h	Yes
VIN_UV_WARN_LIMIT	58h	Yes
VIN_UV_FAULT_LIMIT	59h	Yes
VOUT_OV_WARN_LIMIT	42h	Yes
VOUT_UV_WARN_LIMIT	43h	Yes
IOUT_OC_WARN_LIMIT	4Ah	Yes
IIN_OC_FAULT_LIMIT	5Bh	No
IIN_OC_WARN_LIMIT	5Dh	No
<b>Fault Response Commands</b>		
VOUT_OV_FAULT_RESPONSE	41h	Yes
VOUT_UV_FAULT_RESPONSE	45h	Yes
OT_FAULT_RESPONSE	50h	Yes
UT_FAULT_RESPONSE	54h	Yes
VIN_OV_FAULT_RESPONSE	56h	Yes
VIN_UV_FAULT_RESPONSE	5Ah	Yes
IOUT_OC_FAULT_RESPONSE	47h	Yes
IOUT_UC_FAULT_RESPONSE	4Ch	No
IIN_OC_FAULT_RESPONSE	5Ch	No
<b>Time setting Commands</b>		
TON_DELAY	60h	Yes
TON_RISE	61h	Yes
TON_MAX_FAULT_LIMIT	62h	Yes
TON_MAX_FAULT_RESPONSE	63h	Yes
TOFF_DELAY	64h	Yes
TOFF_FALL	65h	Yes
TOFF_MAX_WARN_LIMIT	66h	Yes
<b>Status Commands (Read Only)</b>		
CLEAR_FAULTS	03h	Yes
STATUS_BYTES	78h	Yes
STATUS_WORD	79h	Yes
STATUS_VOUT	7Ah	Yes
STATUS_IOUT	7Bh	Yes
STATUS_INPUT	7Ch	Yes
STATUS_TEMPERATURE	7Dh	Yes
STATUS_CML	7Eh	Yes
STATUS_OTHER	7Fh	Yes
<b>Monitor Commands (Read Only)</b>		
READ_VIN	88h	Yes

**BMR45' series Fully regulated Advanced Bus Converters**  
 Input 36-75 V, Output up to 60 A / 396 W

EN/LZT 146 395 R10A September 2017

© Flex

Designation	Cmd	Impl
READ_VOUT	8Bh	Yes
READ_IOUT	8Ch	Yes
READ_TEMPERATURE_1	8Dh	Yes
READ_TEMPERATURE_2	8Eh	Yes
READ_FAN_SPEED_1	90h	No
READ_DUTY_CYCLE	94h	Yes
READ_FREQUENCY	95h	Yes
READ_POUT	96h	No
READ_PIN	97h	No
<b>Identification Commands (Read Only)</b>		
PMBUS_REVISION	98h	Yes
MFR_ID	99h	Yes <sup>note1</sup>
MFR_MODEL	9Ah	Yes <sup>note1</sup>
MFR_REVISION	9Bh	Yes <sup>note1</sup>
MFR_LOCATION	9Ch	Yes <sup>note1</sup>
MFR_DATE	9Dh	Yes <sup>note1</sup>
MFR_SERIAL	9Eh	Yes <sup>note1</sup>
<b>Group Commands</b>		
INTERLEAVE	37h	No
<b>Supervisory Commands</b>		
STORE_DEFAULT_ALL	11h	Yes <sup>note2</sup>
RESTORE_DEFAULT_ALL	12h	Yes
STORE_USER_ALL	15h	No
RESTORE_USER_ALL	16h	No
<b>BMR 453/454 Specific Commands</b>		
MFR_POWER_GOOD_POLARITY	D0h	Yes
MFR_VOUT_UPPER_RESISTOR	D2h	Yes <sup>note1</sup>
MFR_VIN_SCALE_MONITOR	D3h	Yes <sup>note1</sup>
MFR_CLA_TABLE_NUM_ROW	D4h	Yes
MFR_CLA_ROW_COEFFICIENTS	D5h	Yes
MFR_STORE_CLA_TABLE	D6h	Yes
MFR_ACTIVE_COEFF_CLA_TABLE	D8h	Yes
MFR_SET_ROM_MODE	D9h	Yes <sup>note1</sup>
MFR_SELECT_TEMP_SENSOR	DCh	Yes
MFR_VIN_OFFSET	DDh	Yes <sup>note1</sup>
MFR_REMOTE_TEMP_CAL	E2h	Yes
MFR_REMOTE_CONTROL	E3h	Yes
MFR_DEAD_BAND_MODE	E4h	Yes <sup>note1</sup>
MFR_DEAD_BAND_DELAY	E5h	Yes <sup>note1</sup>
MFR_TEMP_COEFF	E7h	Yes <sup>note1</sup>
MFR_VOUT_ANALOG_SCALE	E8h	Yes
MFR_READ_VOUT_ANALOG_REF	E9h	Yes

Designation	Cmd	Impl
MFR_DEBUG_BUFF	F0h	Yes
MFR_SETUP_PASSWORD	F1h	Yes
MFR_DISABLE_SECURITY	F2h	Yes
MFR_DEAD_BAND_IOUT_THRESHOLD	F3h	Yes <sup>note1</sup>
MFR_SECURITY_BIT_MASK	F4h	Yes
MFR_PRIMARY_TURN	F5h	Yes <sup>note1</sup>
MFR_SECONDARY_TURN	F6h	Yes <sup>note1</sup>
MFR_SET_DPWM_POLARITY	F7h	Yes <sup>note1</sup>
MFR_ILIM_SOFTSTART	F8h	Yes
MFR_MULTI_PIN_CONFIG	F9h	Yes
MFR_DEAD_BAND_VIN_THRESHOLD	FAh	Yes <sup>note1</sup>
MFR_DEAD_BAND_VIN_IOUT_HYS	FBh	Yes <sup>note1</sup>
MFR_FIRMWARE_VERSION	FCh	Yes <sup>note1</sup>
MFR_MESSAGE_CODE_DEVICE_ID	FDh	Yes <sup>note1</sup>

**Notes:**

Cmd is short for Command.  
 Impl is short for Implemented.

**Note1:**

the content is protected for being overwritten to secure normal operation

**Note 2:**

Power must be kept on at least 700ms after sending STORE\_DEFAULT\_ALL command for data flash refresh.

**BMR45' series Fully regulated Advanced Bus Converters**  
 Input 36-75 V, Output up to 60 A / 396 W

EN/LZT 146 395 R10A September 2017

© Flex

**Mechanical Information - Hole Mount, Open Frame Version**

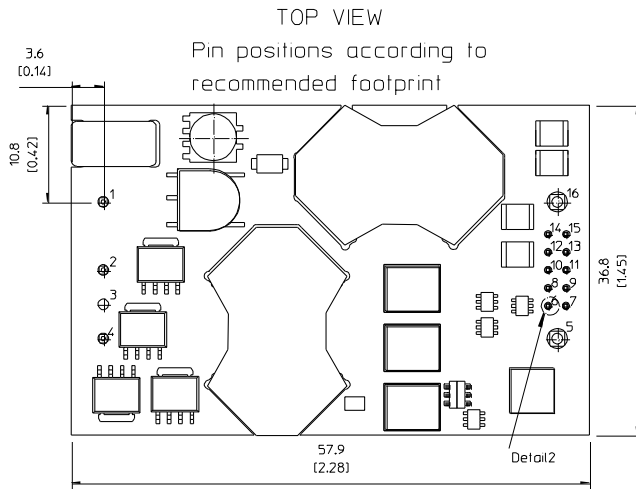
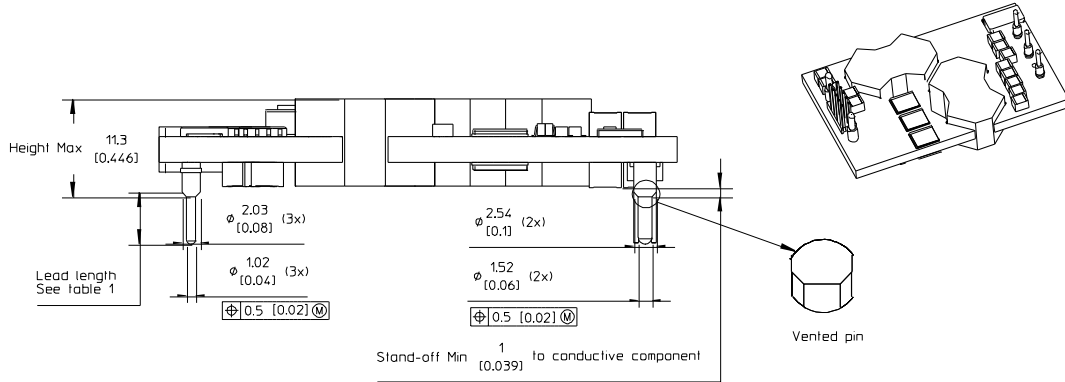

X1	Lead length
0	5.33 [0.210]
2	3.69 [0.145]
3	4.57 [0.180]
4	2.79 [0.110]
5	2.79 [0.110]

Table 1.  
 X1 = Ordering information

**PIN SPECIFICATIONS**  
 Pin 1,2,4,5 & 16 Material: Copper alloy  
 Plating: Min Au 0.1 µm over 1-3 µm Ni.  
 All above pins are vented on both side of shoulder  
 Pin 6-15 Material: Brass  
 Plating: Min Au 0.2 µm over 1.3 µm Ni

**NOTE:**  
 Pin 6-15 are optional and only used if digital communication is requested.

X1-5 Are special customer pins with extra stand off 6.7 mm & Max Height 17 mm.

Position 3 is only used for base plate GND connection pin.

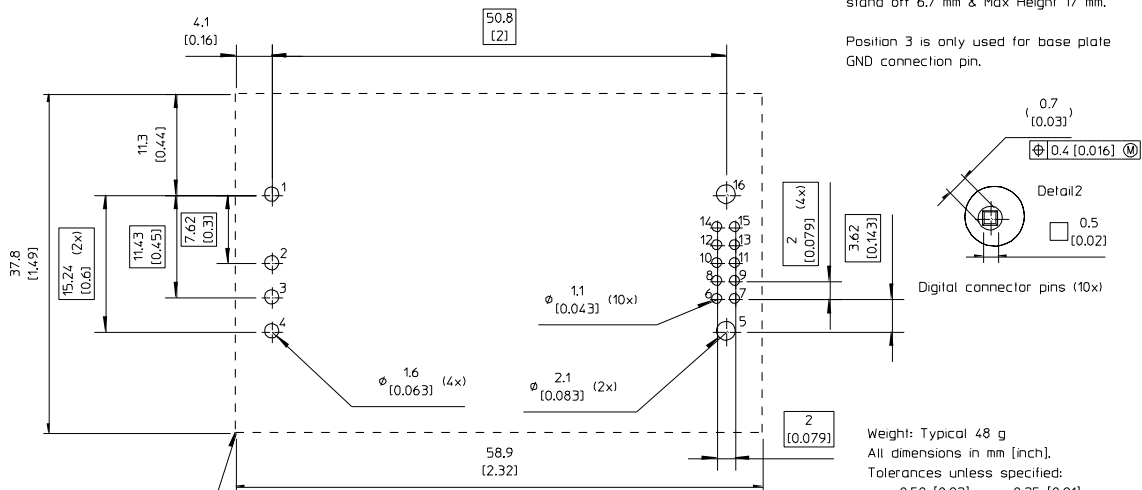

Recommended keep away area for user components.  
 The stand-off in combination with insulating material ensures that requirements as per IEC/EN/UL60950 are met and 1500 V isolation maintained even if open vias or traces are present under the DC/DC converter.

Weight: Typical 48 g  
 All dimensions in mm [inch].  
 Tolerances unless specified:  
 x.x ±0.50 [0.02], x.xx±0.25 [0.01]  
 (not applied on footprint or typical values)



**BMR45' series** Fully regulated Advanced Bus Converters  
 Input 36-75 V, Output up to 60 A / 396 W

EN/LZT 146 395 R10A September 2017

© Flex

**Mechanical Information- Hole Mount, Base Plate Version**

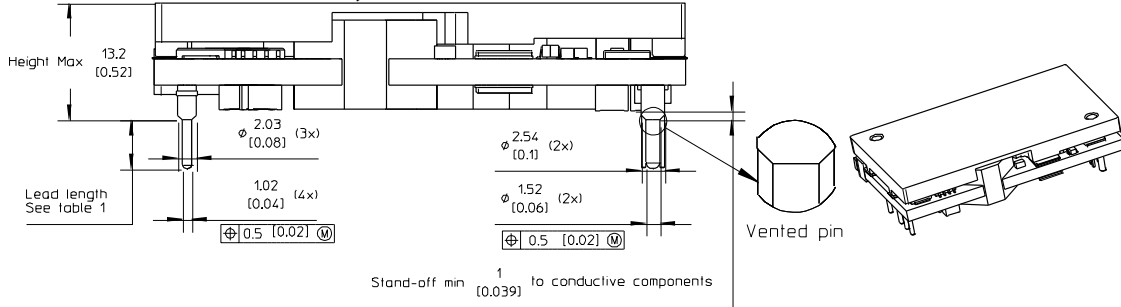

TOP VIEW

Pin positions according to recommended footprint

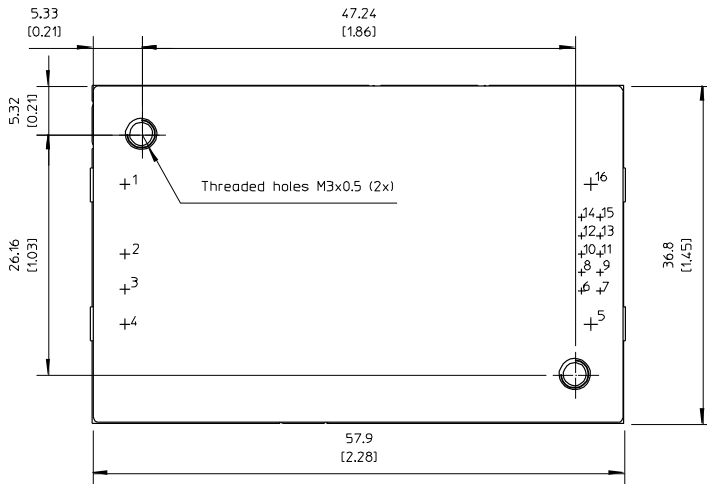

RECOMMENDED FOOTPRINT - TOP VIEW

X1	Lead length
0	5.33 [0.210]
2	3.69 [0.145]
3	4.57 [0.180]
4	2.79 [0.110]
5	2.79 [0.110]

Table 1.

X1 = Ordering information

CASE

Material: Aluminium

For screw attachment apply mounting torque of max 0.44 Nm [3.9 lbf in]. M3 screws must not protrude more than 2.7 mm [0.106] in to the base plate.

PIN SPECIFICATIONS

Pin 1,2,3,4,5 & 16 Material: Copper Alloy

Plating: Min Au 0.1µm over 1-3µm Ni.

All above pins are vented on both side of shoulder.

Pin 6-15 Material: Brass

Plating: Min Au 0.2µm over 1.3µm Ni.

NOTE

Pin 6-15 are optional and only used if digital communication is requested.

Pin 3 is only used for baseplate GND connection.

X1-5 Are special customer pins with extra stand off 6.7 mm & Max height 18.9 mm.

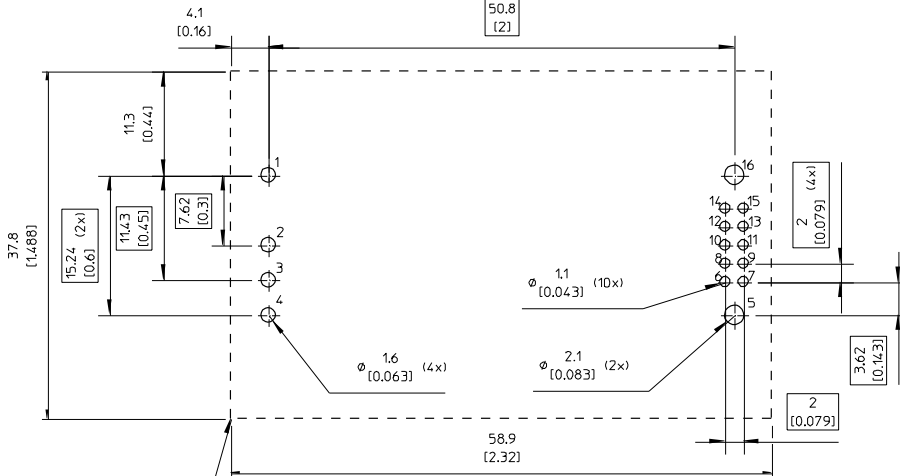

Recommended keep away area for user components.

The stand-off in combination with insulating material ensures that requirements as per IEC/EN/UL60950 are met and 1500 V isolation maintained even if open vias or traces are present under the DC/DC converter.

Weight: Typical 67 g

All dimensions in mm [inch].

Tolerances unless specified:

x.x ±0.50 [0.02], x.xx±0.25 [0.01]

(not applied on footprint or typical values)



**BMR45' series** Fully regulated Advanced Bus Converters  
 Input 36-75 V, Output up to 60 A / 396 W

EN/LZT 146 395 R10A September 2017

© Flex

### Mechanical Information - SMD mount, Open Frame Version

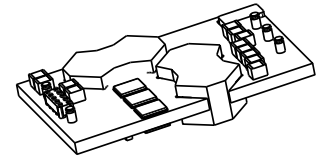
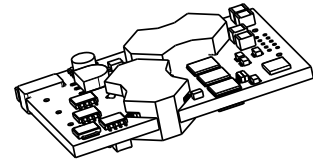
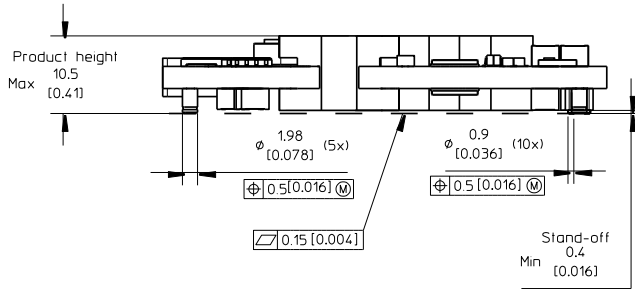

TOP VIEW

Pin positions according to recommended footprint

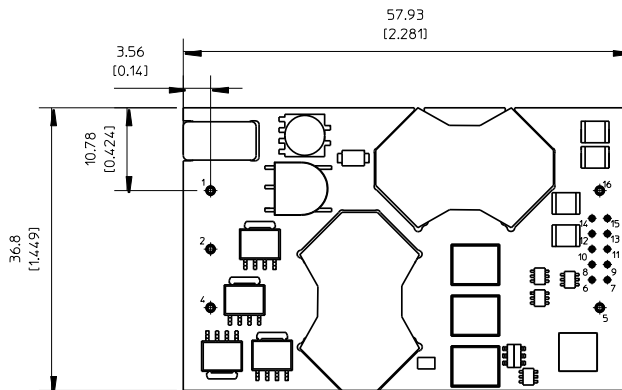

RECOMMENDED FOOTPRINT - TOP VIEW

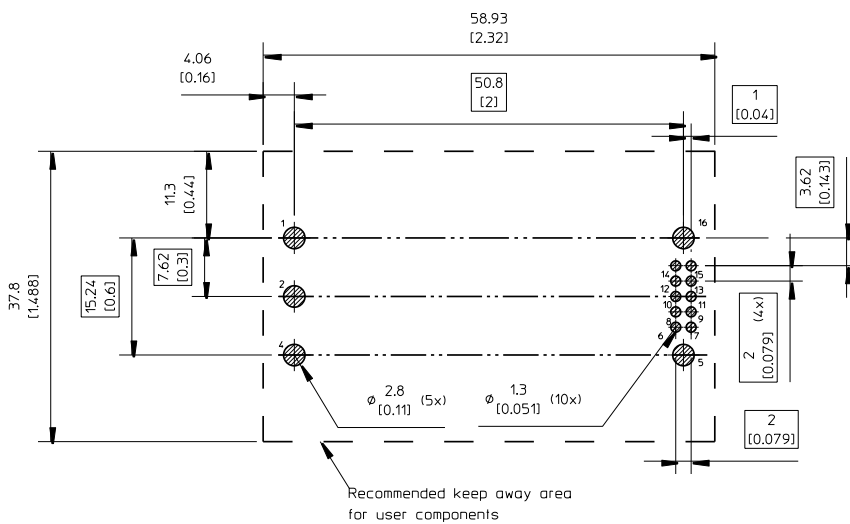

#### NOTES

##### PIN SPECIFICATIONS

- Pin 1,2,4,5 & 16 - Material: Copper alloy  
 Plating: Au 0,1  $\mu$ m over 1-3  $\mu$ m Ni.
- Pin 6-15 - Material: Brass  
 Plating: Au 0,1  $\mu$ m over 2  $\mu$ m Ni.

Weight: Typical 46 g

All dimensions in mm [inch].  
 Tolerances unless specified:  
 x.x +0.5 mm [0.02]  
 x.xx+0.25 mm [0.01]  
 (not applied on footprint or typical values)



**BMR45' series** Fully regulated Advanced Bus Converters  
 Input 36-75 V, Output up to 60 A / 396 W

EN/LZT 146 395 R10A September 2017

© Flex

**Mechanical Information - Hole mount, Open Frame Version, Non Digital Interface**

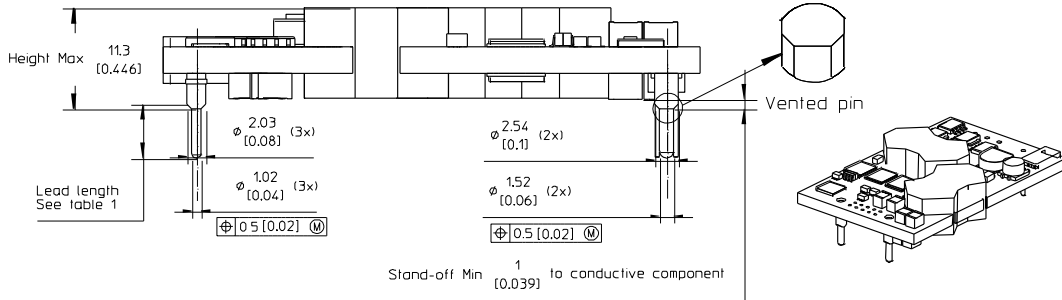

TOP VIEW

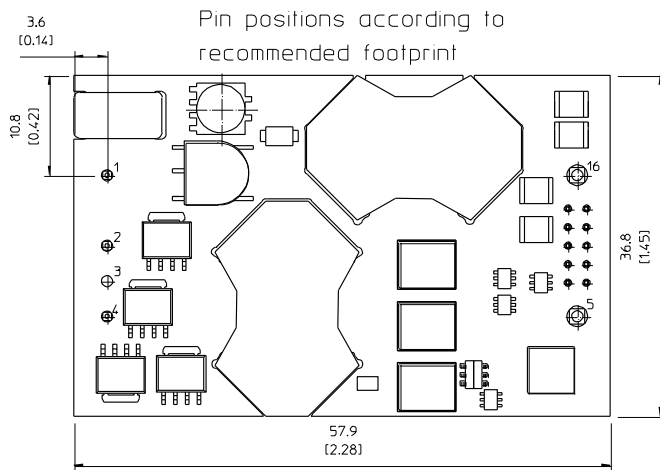

X1	Lead length
0	5.33 [0.210]
2	3.69 [0.145]
3	4.57 [0.180]
4	2.79 [0.110]
5	2.79 [0.110]

Table 1.  
 X1 = Ordering information

PIN SPECIFICATIONS

Pin 1,2,4,5 & 16 Material: Copper alloy  
 Plating: Min Au 0.1  $\mu$ m over 1-3  $\mu$ m Ni.  
 All above pins are vented on both side of shoulder.

NOTE:

X1-5 Are special customer pins with extra stand off 6.7 mm & Max Height 17 mm.

Position 3 is only used for base plate GND connection pin.

RECOMMENDED FOOTPRINT - TOP VIEW

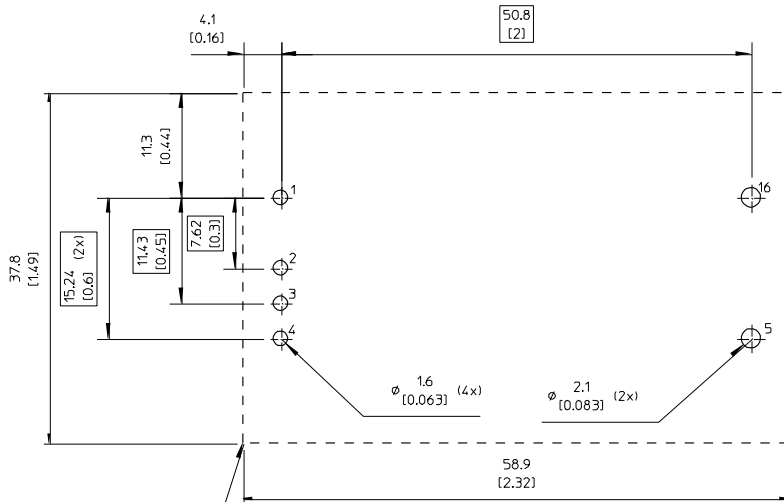

Recommended keep away area for user components.  
 The stand-off in combination with insulating material ensures that requirements as per IEC/EN/UL60950 are met and 1500 V isolation maintained even if open vias or traces are present under the DC/DC converter.

Weight: Typical 48 g  
 All dimensions in mm [inch].  
 Tolerances unless specified:  
 x.x  $\pm$ 0.50 [0.02], x.xx $\pm$ 0.25 [0.01]  
 (not applied on footprint or typical values)



**BMR45' series Fully regulated Advanced Bus Converters**  
 Input 36-75 V, Output up to 60 A / 396 W

EN/LZT 146 395 R10A September 2017

© Flex

**Soldering Information – Surface Mounting**

The surface mount product is intended for forced convection or vapor phase reflow soldering in SnPb and Pb-free processes.

The reflow profile should be optimised to avoid excessive heating of the product. It is recommended to have a sufficiently extended preheat time to ensure an even temperature across the host PCB and it is also recommended to minimize the time in reflow.

A no-clean flux is recommended to avoid entrapment of cleaning fluids in cavities inside the product or between the product and the host board, since cleaning residues may affect long time reliability and isolation voltage.

**Minimum Pin Temperature Recommendations**

Pin number 5 is chosen as reference location for the minimum pin temperature recommendation since this will likely be the coolest solder joint during the reflow process.

**SnPb solder processes**

For SnPb solder processes, a pin temperature ( $T_{PIN}$ ) in excess of the solder melting temperature, ( $T_L$ , 183°C for Sn63Pb37) for more than 30 seconds and a peak temperature of 210°C is recommended to ensure a reliable solder joint.

For dry packed products only: depending on the type of solder paste and flux system used on the host board, up to a recommended maximum temperature of 245°C could be used, if the products are kept in a controlled environment (dry pack handling and storage) prior to assembly.

**Lead-free (Pb-free) solder processes**

For Pb-free solder processes, a pin temperature ( $T_{PIN}$ ) in excess of the solder melting temperature ( $T_L$ , 217 to 221°C for SnAgCu solder alloys) for more than 30 seconds and a peak temperature of 235°C on all solder joints is recommended to ensure a reliable solder joint.

**Maximum Product Temperature Requirements**

Top of the product PCB near pin 2 is chosen as reference location for the maximum (peak) allowed product temperature ( $T_{PRODUCT}$ ) since this will likely be the warmest part of the product during the reflow process.

**SnPb solder processes**

For SnPb solder processes, the product is qualified for MSL 1 according to IPC/JEDEC standard J-STD-020C.

During reflow  $T_{PRODUCT}$  must not exceed 225 °C at any time.

**Pb-free solder processes**

For Pb-free solder processes, the product is qualified for MSL 3 according to IPC/JEDEC standard J-STD-020C.

During reflow  $T_{PRODUCT}$  must not exceed 260 °C at any time.

**Dry Pack Information**

Products intended for Pb-free reflow soldering processes are delivered in standard moisture barrier bags according to IPC/JEDEC standard J-STD-033 (Handling, packing, shipping and use of moisture/reflow sensitivity surface mount devices).

Using products in high temperature Pb-free soldering processes requires dry pack storage and handling. In case the products have been stored in an uncontrolled environment and no longer can be considered dry, the modules must be baked according to J-STD-033.

General reflow process specifications		SnPb eutectic	Pb-free
Average ramp-up ( $T_{PRODUCT}$ )		3°C/s max	3°C/s max
Typical solder melting (liquidus) temperature	$T_L$	183°C	221°C
Minimum reflow time above $T_L$		30 s	30 s
Minimum pin temperature	$T_{PIN}$	210°C	235°C
Peak product temperature	$T_{PRODUCT}$	225°C	260°C
Average ramp-down ( $T_{PRODUCT}$ )		6°C/s max	6°C/s max
Maximum time 25°C to peak		6 minutes	8 minutes

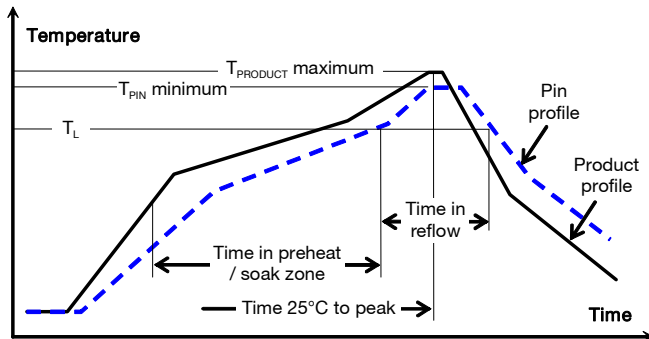

**Thermocoupler Attachment**

Pin 2 for measurement of maximum product temperature  $T_{PRODUCT}$

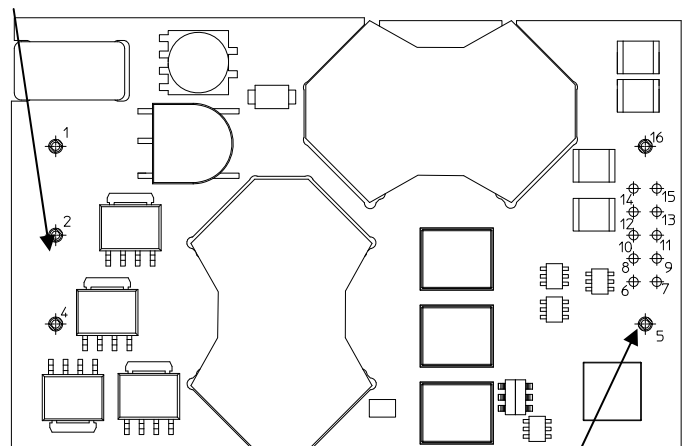

Pin 5 for measurement of minimum Pin (solder joint) temperature  $T_{PIN}$



### BMR45' series Fully regulated Advanced Bus Converters Input 36-75 V, Output up to 60 A / 396 W

EN/LZT 146 395 R10A September 2017

© Flex

#### Delivery Package Information – Surface Mount Version

The products are delivered in antistatic injection molded trays (Jedec design guide 4.10D standard).

Tray Specifications	
<b>Material</b>	Antistatic PPE
<b>Surface resistance</b>	$10^5 < \text{Ohm/square} < 10^{12}$
<b>Bakability</b>	The trays can be baked at maximum 125°C for 48 hours
<b>Tray thickness</b>	14.50 mm 0.571 [inch]
<b>Box capacity</b>	20 products (2 full trays/box)
<b>Tray weight</b>	125 g empty, 574 g full tray

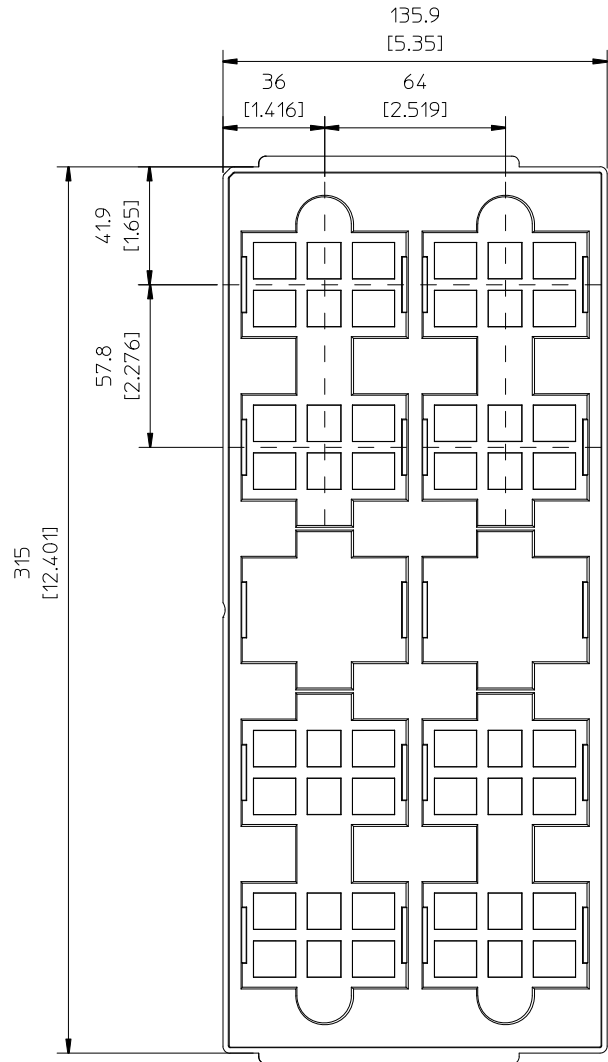

JEDEC standard tray for 2x5 = 10 products.

All dimensions in mm [inch]

Tolerances: X.x ±0.26 [0.01], X.xx ±0.13 [0.005]

Note: pick up positions refer to center of pocket.

See mechanical drawing for exact location on product.

**BMR45' series Fully regulated Advanced Bus Converters**  
 Input 36-75 V, Output up to 60 A / 396 W

EN/LZT 146 395 R10A September 2017

© Flex

**Soldering Information – Hole Mounting**

The hole mounted product is intended for plated through hole mounting by wave or manual soldering. The pin temperature is specified to maximum to 270°C for maximum 10 seconds.

A maximum preheat rate of 4°C/s and maximum preheat temperature of 150°C is suggested. When soldering by hand, care should be taken to avoid direct contact between the hot soldering iron tip and the pins for more than a few seconds in order to prevent overheating.

A no-clean flux is recommended to avoid entrapment of cleaning fluids in cavities inside the product or between the product and the host board. The cleaning residues may affect long time reliability and isolation voltage.

**Delivery Package Information – Hole Mount Version**

The products are delivered in antistatic trays.

Tray Specifications	
<b>Material</b>	PE Foam
<b>Surface resistance</b>	$10^5 < \text{Ohm/square} < 10^{11}$
<b>Bakability</b>	The trays are not bakeable
<b>Tray capacity</b>	20 converters/tray
<b>Box capacity</b>	Product – Open frame /Base plate option 60 products (3 full trays /box)
<b>Weight</b>	Product – Open frame 1100 g full tray, 140g empty tray Product – Base plate option 1480 g full tray, 140g empty tray

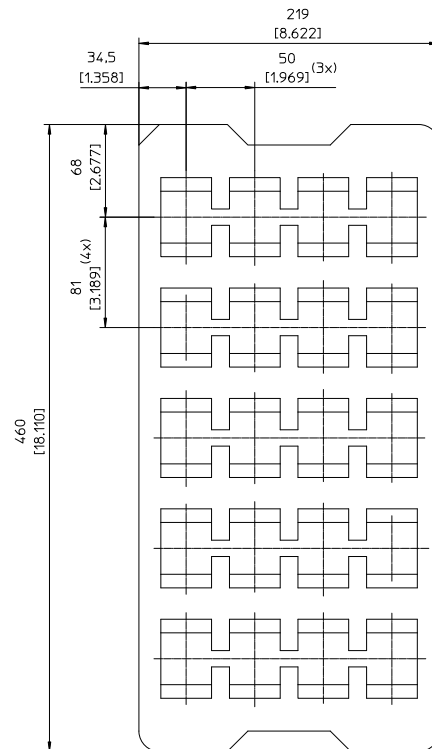

**BMR45' series Fully regulated Advanced Bus Converters**  
 Input 36-75 V, Output up to 60 A / 396 W

EN/LZT 146 395 R10A September 2017

© Flex

**Product Qualification Specification**

Characteristics			
External visual inspection	IPC-A-610		
Change of temperature (Temperature cycling)	IEC 60068-2-14 Na	Temperature range Number of cycles Dwell/transfer time	-40 to 100°C 1000 15 min/0-1 min
Cold (in operation)	IEC 60068-2-1 Ad	Temperature T <sub>A</sub> Duration	-45°C 72 h
Damp heat	IEC 60068-2-67 Cy	Temperature Humidity Duration	85°C 85 % RH 1000 hours
Dry heat	IEC 60068-2-2 Bd	Temperature Duration	125°C 1000 h
Electrostatic discharge susceptibility	IEC 61340-3-1, JESD 22-A114 IEC 61340-3-2, JESD 22-A115	Human body model (HBM) Machine Model (MM)	Class 2, 2000 V Class 3, 200 V
Immersion in cleaning solvents	IEC 60068-2-45 XA, method 2	Water Glycol ether Isopropyl alcohol	55°C 35°C 35°C
Mechanical shock	IEC 60068-2-27 Ea	Peak acceleration Duration	100 g 6 ms
Moisture reflow sensitivity <sup>1</sup>	J-STD-020C	Level 1 (SnPb-eutectic) Level 3 (Pb Free)	225°C 260°C
Operational life test	MIL-STD-202G, method 108A	Duration	1000 h
Resistance to soldering heat <sup>2</sup>	IEC 60068-2-20 Tb, method 1A	Solder temperature Duration	270°C 10-13 s
Robustness of terminations	IEC 60068-2-21 Test Ua1 IEC 60068-2-21 Test Ue1	Through hole mount products Surface mount products	All leads All leads
Solderability	IEC 60068-2-58 test Td <sup>1</sup>	Preconditioning Temperature, SnPb Eutectic Temperature, Pb-free	150°C dry bake 16 h 215°C 235°C
	IEC 60068-2-20 test Ta <sup>2</sup>	Preconditioning Temperature, SnPb Eutectic Temperature, Pb-free	Steam ageing 235°C 245°C
Vibration, broad band random	IEC 60068-2-64 Fh, method 1	Frequency Spectral density Duration	10 to 500 Hz 0.07 g <sup>2</sup> /Hz 10 min in each direction

**Notes**
<sup>1</sup> Only for products intended for reflow soldering (surface mount products)

<sup>2</sup> Only for products intended for wave soldering (plated through hole products)