

**PACKAGE DIMENSIONS**

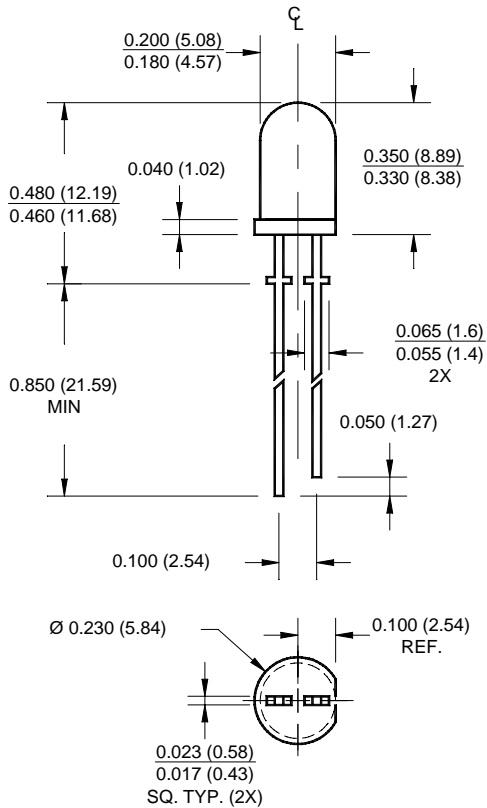

**HLMP-3X50A**

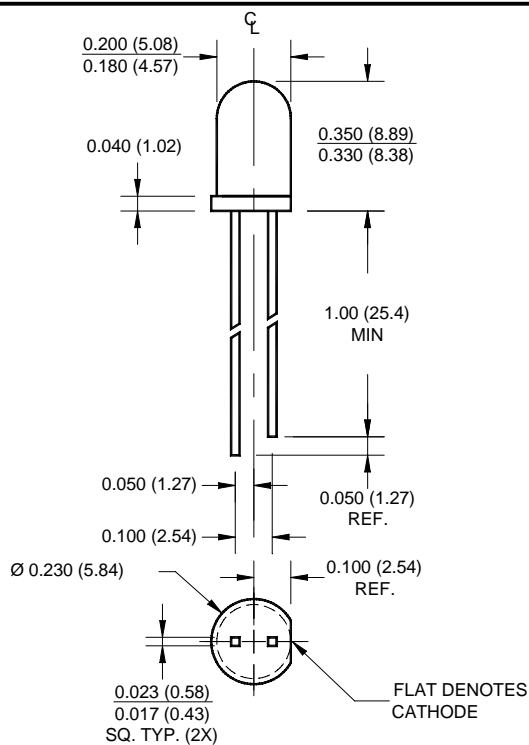

**MV3X50**

**HLMP-3X50A  
MV3X50**

**FEATURES**

- Pale tint
- Sturdy leads with or without stand-off on T-1 3/4
- Excellent for small area backlighting
- HER
  - HLMP-3750A
  - MV3750
- Green
  - HLMP-3950A
  - MV3450
- Yellow
  - HLMP-3850A
  - MV3350

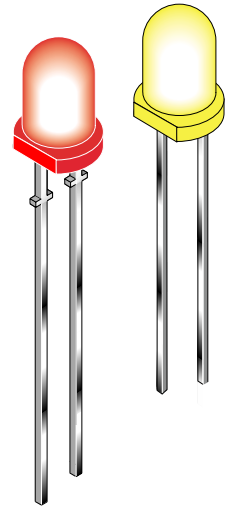

**DESCRIPTION**

The HLMP-3X50 series consists of tinted and water clear T-1 3/4 LED lamps with standoffs.

The MV3X50 series is the same as Agilent's HLMP-3X50A series, except for the standoffs.

Both series are available in red, yellow and green with a minimum intensity of 80mcd.

**NOTES:**

ALL DIMENSIONS ARE IN INCHES (mm).

## ABSOLUTE MAXIMUM RATING (T<sub>A</sub> =25°C)

Parameter	HER	YELLOW	GREEN	UNITS
Power Dissipation	135	85	135	mW
Peak Forward Current	90	60	90	mA
Continuous DC Forward Current	30	20	30	mA
Lead Soldering Time at 260° C	5	5	5	sec
Operating Temperature	-55 to +100	-55 to +100	-50 to +100	°C
Storage Temperature	-55 to +100	-55 to +100	-50 to +100	°C

## ELECTRICAL / OPTICAL CHARACTERISTICS (T<sub>A</sub> =25°C)

Parameter	MV3750	MV3350	MV3450	Condition
	HLMP-3750A	HLMP-3850A	HLMP-3950A	
Luminous Intensity (mcd)				I <sub>F</sub> = 20mA
Minimum	80	80	80	
Typical	150	150	150	
Forward Voltage (V)				I <sub>F</sub> = 20mA
Maximum	3.0	3.0	3.0	
Typical	2.2	2.2	2.2	
Peak Wavelength (nm)	635	585	565	I <sub>F</sub> = 20mA
Reverse Voltage (V)	5	5	5	I <sub>R</sub> = 100μA
Viewing Angle (°)	24	24	24	I <sub>F</sub> = 20mA

**TYPICAL PERFORMANCE CURVES ( $T_A = 25^\circ\text{C}$ )**

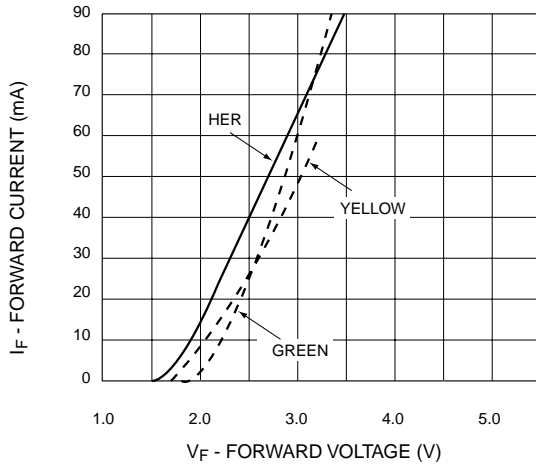

**Fig. 1 Forward Current vs. Forward Voltage**

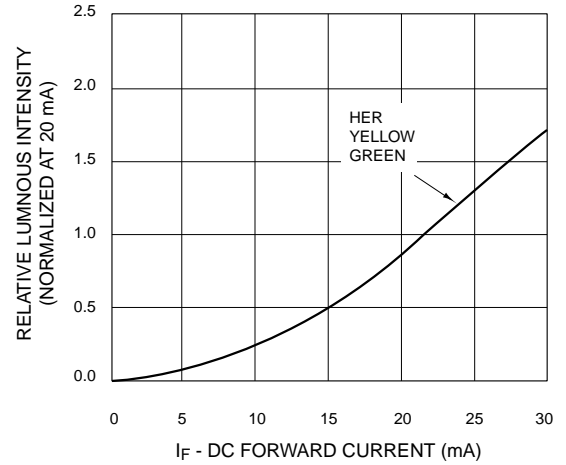

**Fig. 2 Relative Luminous Intensity vs. DC Forward Current**

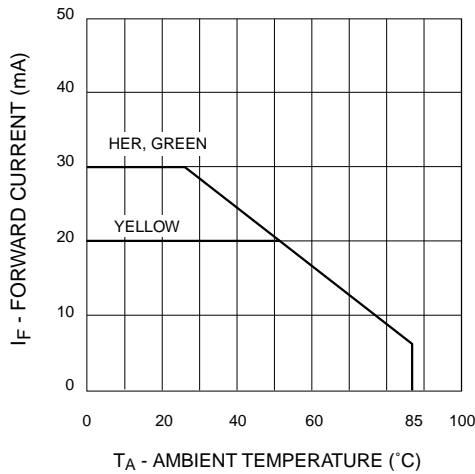

**Fig. 3 Current Derating Curve**

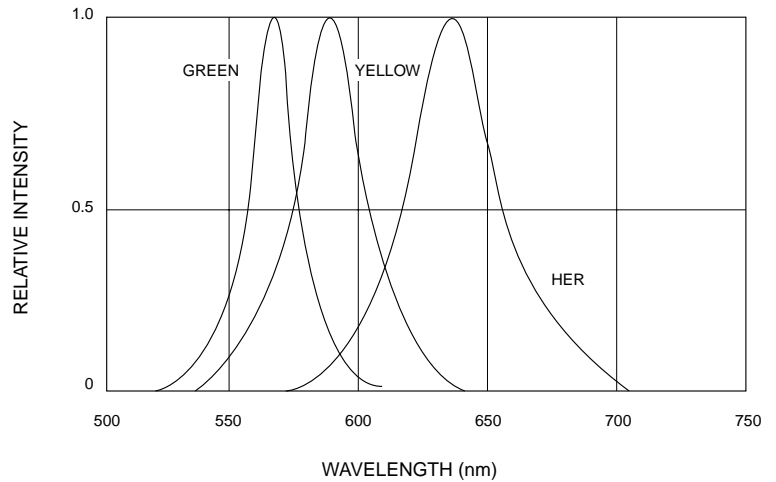

**Fig. 4 Relative Intensity vs. Peak Wavelength**

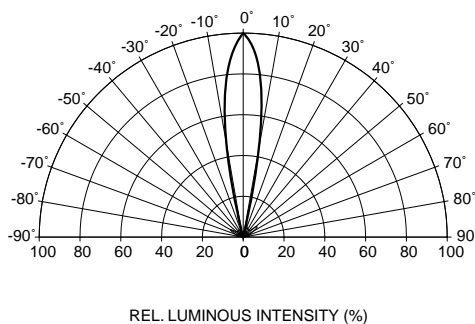

**Fig. 5 Radiation Diagram**

## **DISCLAIMER**

FAIRCHILD SEMICONDUCTOR RESERVES THE THE RIGHT TO MAKE CHANGES WITHOUT FURTHER NOTICE TO ANY PRODUCTS HEREIN TO IMPROVE RELIABILITY, FUNCTION OR DESIGN. FAIRCHILD DOES NOT ASSUME ANY LIABILITY ARISING OUT OF THE APPLICATION OR USE OF ANY PRODUCT OR CIRCUIT DESCRIBED HEREIN; NEITHER DOES IT CONVEY ANY LICENSE UNDER ITS PATENT RIGHTS, NOR THE RIGHTS OF OTHERS.

## **LIFE SUPPORT POLICY**

FAIRCHILD'S PRODUCTS ARE NOT AUTHORIZED FOR USE AS CRITICAL COMPONENTS IN LIFE SUPPORT DEVICES OR SYSTEMS WITHOUT THE EXPRESS WRITTEN APPROVAL OF THE PRESIDENT OF FAIRCHILD SEMICONDUCTOR CORPORATION. As used herein:

1. Life support devices or systems are devices or systems which, (a) are intended for surgical implant into the body, or (b) support or sustain life, and (c) whose failure to perform when properly used in accordance with instructions for use provided in labeling, can be reasonably expected to result in a significant injury of the user.
2. A critical component in any component of a life support device or system whose failure to perform can be reasonably expected to cause the failure of the life support device or system, or to affect its safety or effectiveness.