

EA DOGS164-A

INCL. CONTROLLER SSD1803A WITH SPI, I²C

available at 1 piece!
Switchable font height

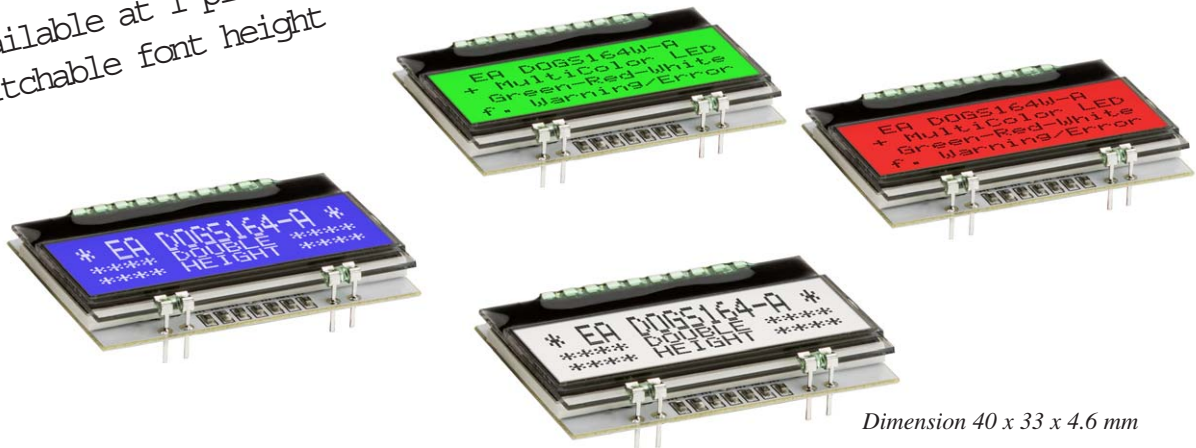

Dimension 40 x 33 x 4.6 mm

TECHNICAL DATA

- * HIGH-CONTRAST LCD SUPERTWIST DISPLAY
- * OPTIONAL LED BACKLIGHT UNITS IN DIFFERENT COLORS
- * 4x16 CHARACTER WITH 3.2 mm SWITCHABLE TO 2X16 WITH 6.0 mm HEIGHT
- * SSD1803A CONTROLLER FOR SPI (3-/4-WIRE) AND I²C (2-WIRE) INTERFACE
- * SINGLE POWER SUPPLY +3.3V (typically 440µA)
- * NO ADDITIONAL VOLTAGES REQUIRED
- * OPERATING TEMPERATURE RANGE -20 THROUGH +70°C
- * LED BACKLIGHT 3~45mA@3.3V
- * NO MOUNTING REQUIRED, SIMPLY SOLDER INTO PCB
- * 3 DIFFERENT CHARACTER SETS (CYRILLIC, ENGLISH-JAPANESE AND EUROPEAN) INCLUDED IN THE SAME CONTROLLER
- * VIEWING DIRECTION SELECTABLE: BOTTOM AND TOP VIEW

ORDERING CODE

LCD MODULE 4x16 - 3.2 mm

x: *B* = blue background transmissive
W = white background transfective
N = white background reflective

EA DOGS164x-A

LED-BACKLIGHT AMBER
LED-BACKLIGHT GREEN / RED / WHITE

EA LED40X33-A
EA LED40X33-ERW

ACCESSORIES

USB-TESTBOARD FOR PC (WINDOWS)
SOCKET CONNECTOR 4,8mm HEIGHT (2 PCS REQUIRED)

EA 9780-4USB
EA FL-10P

EA DOG SERIES

With its EA DOG series, ELECTRONIC ASSEMBLY presents the world's first display series which will run on 3.3 V systems without auxiliary power.

Unlike normal LCD modules, you order the display and the corresponding backlight separately. This gives you a wealth of possible combinations.

Designed for compact hand-held devices, this modern LCD range provides a number of real benefits with or without backlight:

- * extremely compact at 40x33 mm at the standard font size of 3.2 mm (4 x 16)
- * ultra-flat at 2.0 mm without backlight or 4.6 mm including LED backlight
- * SPI interface (2-/3-/4-wire) and I²C (2-wire)
- * typical power consumption of only 440µA in full operation (LED white backlight as of 3mA)
- * easy installation by simply soldering into the board
- * A whole range of design variants can be supplied as of single units
- * Changing background color

LED BACKLIGHTS

2 different variants are available for individual backlighting: monochrome amber and multi-color green/red/white.

For the amber backlight, 2 separate LED paths are available, which can be switched in parallel or in series to ideally match the system voltage. This means that all the backlights can be run either at 3.3 V and higher voltages.

Operation of the backlight requires an external series resistor for current limiting. This can be calculated by $R=U/I$; you will find the values in the table. To improve life time it is recommended to use a current source only.

amber EA LED40x33-A	Forward voltage	Current max.	Limiting resistor	
			@ 3,3 V	@ 5 V
Connected in parallel	2,1 V	60 mA	20 ohm	48 ohm
Connected in series	4,2 V	30 mA	-	27 ohm

green/red/white EA LED40X33-ERW	Forward voltage	Current max.	Limiting resistor	
			@ 3,3 V	@ 5 V
green path	3,0V	45 mA	7 ohm	45 ohm
red path	2,1 V	45 mA	27 ohm	65 ohm
white path	3,0 V	30 mA	10 ohm	67 ohm

The operating life time of the amber backlight is 100,000 hours, those for the 3-color version is a bit shorter (@25°C).

Important: Never operate the backlight directly on a 5 V/3.3V supply, as this can immediately destroy the LEDs!

INSTALLATION

First, the display and the corresponding backlight are clipped together. The complete unit is then inserted into a PCB and soldered. Note that the 4 pins for the backlight must also be soldered from the top with less tin.

Important: There are one or two protective films on the display (top and/or rear side) and one on each backlight. Those have to be removed during or after production.

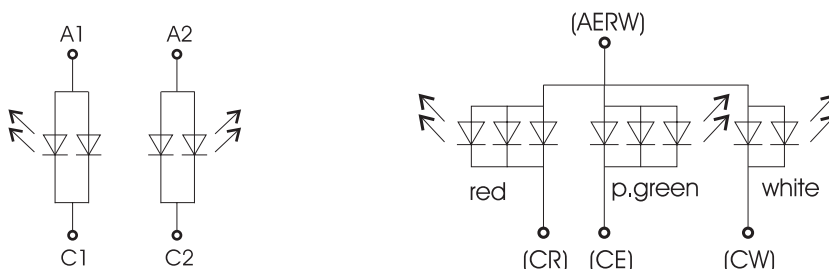

4 DIFFERENT TECHNOLOGIES

As a standard we provide 3 different technologies as STN and FSTN:

display type	technology	optional backlight	readability	display color non backlighted	display color backlighted	recommended backlight color
	FSTN pos. transfective	it's fine with and without backlight	readable even without backlight	black on white	black on backlight color	all
	STN neg. blue transmissive	usage only with backlight	---	---	white backlight on blue background	white
	FSTN pos. white reflective	no backlight possible	finest readable without backlight	black on white	---	---

2 DIFFERENT BACKLIGHTS

2 different backlight modules are available to match equipment's design as much as possible. The most effective and brightest one is the multicolor version EA LED40x33-ERW.



EA LED40x33-ERW
Tri-color green red white

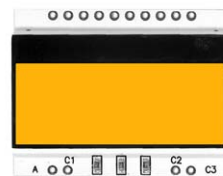

EA LED40x33-A
Amber

When you can see black and white pictures only here on this page then you're able to download a coloured version from our website <http://www.lcd-module.de/eng/pdf/doma/dogs164e.pdf>

USB-TEST BOARD EA 9780-3USB

For easy startup, a USB test board is available that can be connected to a PC. An USB cable and a Windows software is supplied with the product. This allows individual text and to be displayed directly on the connected display.

SIMULATION WITH WINDOWS

Without ordering a display, the simulator software may show all the displays and colors even without the hardware. You can download for free from our website. There's no need to install, it's a simple EXE file, also running from USB stick e.g. http://www.lcd-module.de/deu/disk/startdog_V43.zip

APPLICATION EXAMPLES

Different wiring must be used depending on the interface.

Note that the COG technology means that the current capacity of the outputs is limited. Therefore, a large load on the bus may cause signal loops and unclear levels. If in doubt, additional pull-down resistors (8051) are required or additional waits/NOPs must be incorporated.

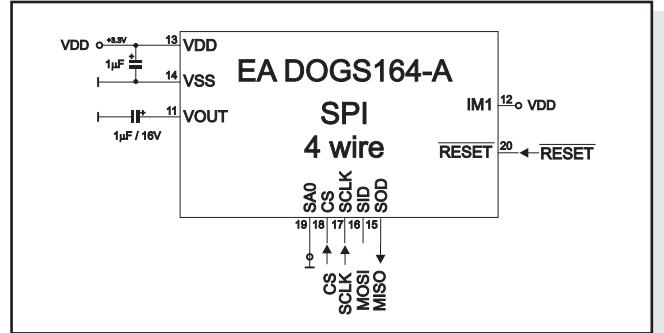
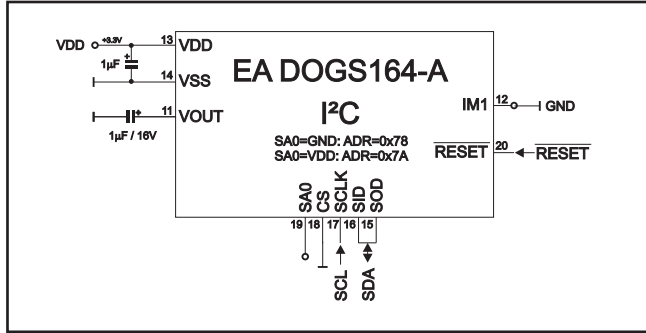

To guarantee an error-free functionality and initialization of display it is recommended to operate the reset input actively. This can be done via microcontroller port or external circuit. Here's an application example:

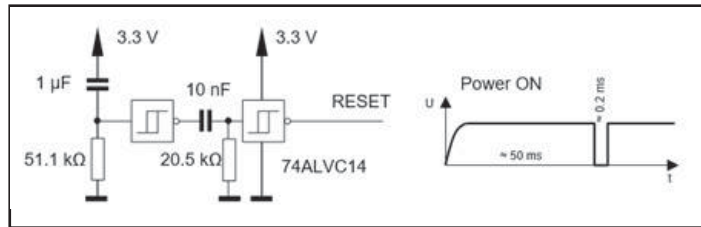

INITIALIZATION EXAMPLE

Initialization Example SPI and I2C												
Command	RS	R/W	DB7	DB6	DB5	DB4	DB3	DB2	DB1	DB0	Hex	Remark
Function Set	0	0	0	0	1	1	1	0	1	0	\$3A	8 bit data length extension Bit RE=1; REV=0
Extended function set	0	0	0	0	0	0	1	0	0	1	\$09	4 line display
Entry mode set	0	0	0	0	0	0	0	1	1	0	\$06	bottom view
Bias setting	0	0	0	0	0	1	1	1	1	0	\$1E	BS1=1
Function Set	0	0	0	0	1	1	1	0	0	1	\$39	8 bit data length extension Bit RE=0; IS=1
Internal OSC	0	0	0	0	0	1	1	0	1	1	\$1B	BS0=1 -> Bias=1/6
Follower control	0	0	0	1	1	0	1	1	0	0	\$6C	Divider on and set value
Power control	0	0	0	1	0	1	0	1	1	0	\$56	Booster on and set contrast (DB1=C5, DB0=C4)
Contrast Set	0	0	0	1	1	1	1	0	1	0	\$7A	Set contrast (DB3-DB0=C3-C0)
Function Set	0	0	0	0	1	1	1	0	0	0	\$38	8 bit data length extension Bit RE=0; IS=0
Display On	0	0	0	0	0	0	1	1	1	1	\$0F	Display on, cursor on, blink on

12:00 VIEWING ANGLE, TOP VIEW OPTION

If the display is read mostly from above (on the front of a laboratory power supply unit, for example), the preferred angle of viewing can be set to 12 o'clock. This rotates the display by 180°. A slightly different initialization setup is required for this. The line address is incremented by 10.

Change view												
Command	RS	R/W	DB7	DB6	DB5	DB4	DB3	DB2	DB1	DB0	Hex	Remark
Function Set	0	0	0	0	1	1	1	0	1	0	\$3A	3-Bit data length extension Bit RE=1; IS=0
Entry Mode	0	0	0	0	0	0	0	1	BDC	BDS	\$0X	\$06=bottom view; \$05 = top view
Function Set	0	0	0	0	1	1	1	0	0	0	\$38	3-Bit data length extension Bit RE=0; IS=0



Orientation 6:00 (Bottom View)



Orientation 12:00 (Top)



SETTING THE CONTRAST

The contrast for the EA DOGS164-A can be set by command. This is done using bits C0 through C5 in the commands "Contrast Set" and "Power/Icon Control/Contrast Set". Generally, the contrast is set once only. Thanks to the integrated temperature compensation function, it's kept constant all over the entire operating temperature range (-20 to +70°C).

Contrast set												
Command	RS	R/W	DB7	DB6	DB5	DB4	DB3	DB2	DB1	DB0	Hex	Remark
Function Set	0	0	0	0	1	1	1	0	0	1	\$39	8-Bit data length extension Bit RE=0; IS=1
Power control	0	0	0	1	0	1	0	1	1	0	\$56	Booster on and set contrast (DB1=C5, DB0=C4)
Contrast Set	0	0	0	1	1	1	1	0	1	0	\$7A	Set contrast (DB3-DB0=C3-C0)
Function Set	0	0	0	0	1	1	1	0	0	0	\$38	8-Bit data length extension Bit RE=0; IS=0

DDRAM ADDRESS / LINE COUNT

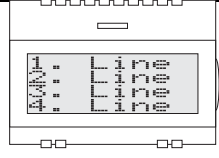
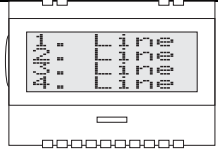
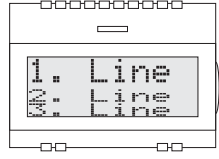
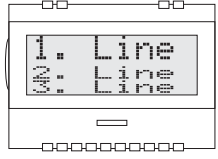
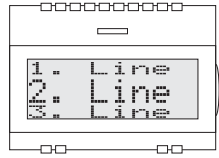
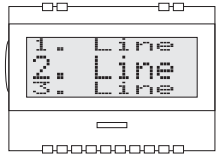
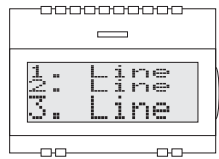
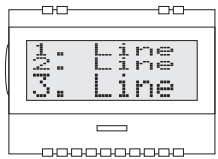
The display controller SSD1803A affords the opportunity of double height fonts. The different line combinations with its corresponding initialization commands are shown in the following table. The DDRAM address depends on line count and viewing direction.

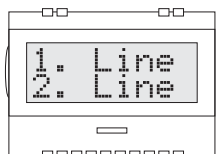
Bottom view	DDRAM ADDRESS (0x80+adr)	Top view	DDRAM ADDRESS (0x80+adr)	Set line count (RS = 0, R/W = 0)
	0x00 0x20 0x40 0x60		0x04 0x24 0x44 0x64	0x38 ->Function set: DH = 0
	0x00 0x20 0x40		0x04 0x24 0x44	0x3A ->Function set: RE = 1 0x1F -> 3 Lines top 0x3C ->Function set: RE = 0, DH = 1
	0x00 0x20 0x40		0x04 0x24 0x44	0x3A ->Function set: RE = 1 0x17 -> 3 Lines middle 0x3C ->Function set: RE = 0, DH = 1
	0x00 0x20 0x40		0x04 0x24 0x44	0x3A ->Function set: RE = 1 0x13 -> 3 Lines bottom 0x3C ->Function set: RE = 0, DH = 1
	0x00 0x20		0x04 0x24	0x3A ->Function set: RE = 1 0x1B -> 2 Lines 0x3C ->Function set: RE = 0, DH = 1

Further information about the commands of the SSD1803A, please refer to the datasheet:
http://www.lcd-module.de/fileadmin/eng/pdf/zubehoer/ssd1803a_2_0.pdf

CHARACTER SET

The controller has 3 built-in character sets. They can be selected with the command "ROM-Selection" in the extended command set.

ROM A

b3-0 b7-4	0 1 2 3 4 5 6 7 8 9 A B C D E F
00	█
10	█
20	!"#\$%&'()*+,-./
30	0123456789:;<=>?
40	!ABCDEFGHIJKLMNO
50	PQRSTUVWXYZ[^_`
60	~abcdefghijklmnopqrstuvwxyz
70	0123456789:;<=>?
80	ABCDEFGHIJKLMNO
90	PQRSTUVWXYZ[^_`
A0	~abcdefghijklmnopqrstuvwxyz
B0	0123456789:;<=>?
C0	ABCDEFGHIJKLMNO
D0	PQRSTUVWXYZ[^_`
E0	~abcdefghijklmnopqrstuvwxyz
F0	█

ROM B

b3-0 b7-4	0 1 2 3 4 5 6 7 8 9 A B C D E F
00	█
10	█
20	!"#\$%&'()*+,-./
30	0123456789:;<=>?
40	@ABCDEFGHIJKLMNO
50	PQRSTUVWXYZ[\]^_`
60	~abcdefghijklmnopqrstuvwxyz
70	0123456789:;<=>?
80	ABCDEFGHIJKLMNO
90	PQRSTUVWXYZ[\]^_`
A0	~abcdefghijklmnopqrstuvwxyz
B0	0123456789:;<=>?
C0	ABCDEFGHIJKLMNO
D0	PQRSTUVWXYZ[\]^_`
E0	~abcdefghijklmnopqrstuvwxyz
F0	█

ROM C

b3-0 b7-4	0 1 2 3 4 5 6 7 8 9 A B C D E F
00	█
10	█
20	!"#\$%&'()*+,-./
30	0123456789:;<=>?
40	@ABCDEFGHIJKLMNO
50	PQRSTUVWXYZ[\]^_`
60	~abcdefghijklmnopqrstuvwxyz
70	0123456789:;<=>?
80	ABCDEFGHIJKLMNO
90	PQRSTUVWXYZ[\]^_`
A0	~abcdefghijklmnopqrstuvwxyz
B0	0123456789:;<=>?
C0	ABCDEFGHIJKLMNO
D0	PQRSTUVWXYZ[\]^_`
E0	~abcdefghijklmnopqrstuvwxyz
F0	█

Change character table												
Command	RS	R/W	DB7	DB6	DB5	DB4	DB3	DB2	DB1	DB0	Hex	Remark
Function Set	0	0	0	0	1	1	1	0	1	0	\$3A	8-Bit data length extension Bit RE=1
ROM Selection	0	0	0	0	0	0	1	0	0	1	\$72	ROM selection double byte command
	1	0	0	0	0	0	R2	R1	0	0	\$0X	\$00 = ROMA; \$04 = ROMB; \$0C = ROMC
Function Set	0	0	0	0	1	1	1	0	0	0	\$38	8-Bit data length extension Bit RE=0

CREATING YOUR OWN CHARACTERS

It's possible to create 8 own additional characters (ASCII Codes 0..7) to the fixes ROM codes. Please be informed, that RE- and IS-Bit need to be 0.

- 1.) The command "CG RAM Address Set" defines the ASCII code (Bit 3,4,5) and the dot line (Bit 0,1,2) of the new character. Example demonstrates creating ASCII code \$00.
- 2.) Doing 8 times the write command "Data Write" defines line by line the new character. 8th. byte stands for the cursor line.
- 3.) The new defined character can be used as a "normal" ASCII code (0..7); use with "DD RAM Address Set" and "Data Write".

Character-data								
Bit								
7	6	5	4	3	2	1	0	Hex
X	X	X	0	0	1	0	0	\$04
			0	0	1	0	0	\$04
			0	0	1	0	0	\$04
			0	0	1	0	0	\$04
			1	0	1	0	1	\$15
			0	1	1	1	0	\$0E
			0	0	1	0	0	\$04
			0	0	0	0	0	\$00

Define own character												
Command	RS	R/W	DB7	DB6	DB5	DB4	DB3	DB2	DB1	DB0	Hex	Remark
CG-RAM address set	0	0	0	1	AC5	AC4	AC3	AC2	AC1	AC0	\$40	Set address of character \$40=0; \$48=1; \$54=2...\$78=7
Character-data	1	0	x	x	x	0	0	1	0	0	\$04	first line
						0	0	1	0	0	\$04	second line
						0	0	1	0	0	\$04	third line
						0	0	1	0	0	\$04	fourth line
						1	0	1	0	1	\$15	fifth line
						0	1	1	1	0	\$0E	sixth line
						0	0	1	0	0	\$04	seventh line
						0	0	0	0	0	\$00	eighth line, cursor line

SERIAL INTERFACE (SPI, MODE3)

The serial interface always needs a synchronization byte. In write mode, the byte to send has to be divided in two bytes, into the "lower data" and "upper data". Please refer to the chart below. The maximum clock frequency for SCLK is 1 MHz.

SPI, 1-/2-/3-WIRE

With 2 to 4 lines SCLK, SID and CS, SOD (if necessary) the display EA DOGS164-A may be connected directly to the SPI interface of a μ C.

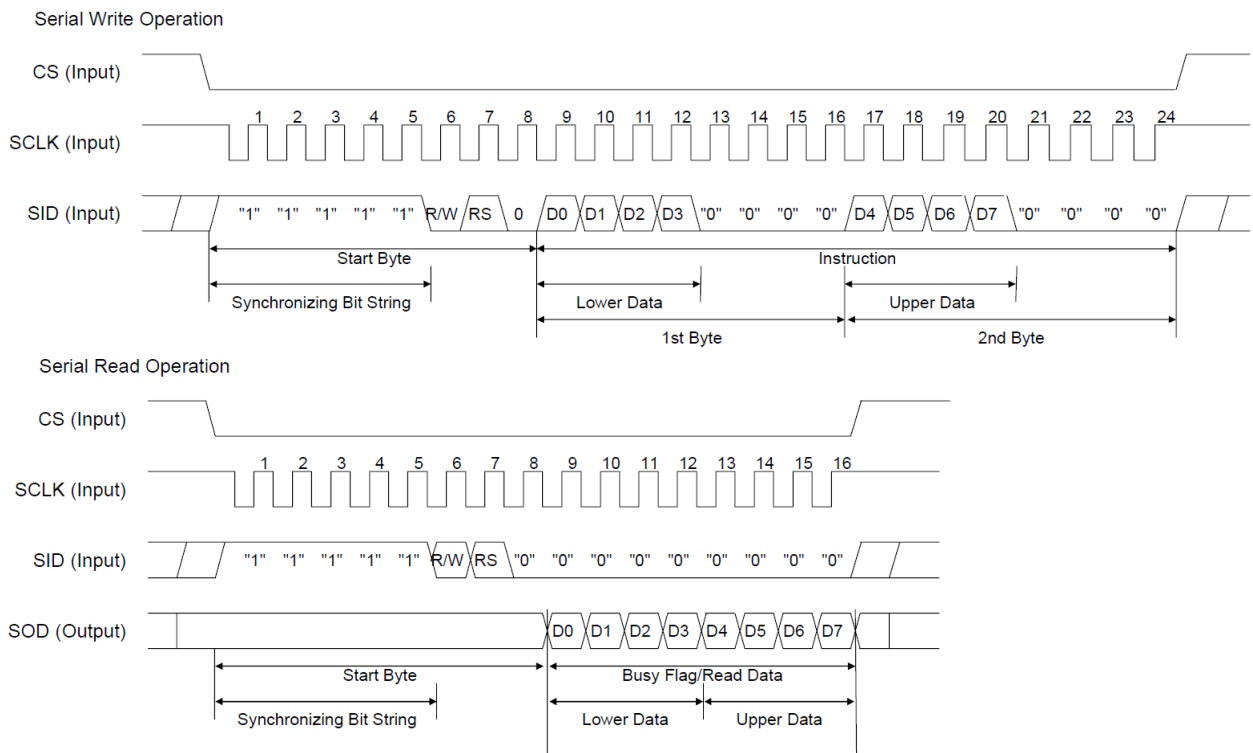

I²C INTERFACE

The display can be assigned to the slave address 0x78 (0x3C) if pin SA0 is connected to VSS or to 0x7A (0x3D) if SA0 is high. After transferring the start condition, the hardware address, together with the Read(1)/Write(0) bit has to be transmitted. While writing to the display, after the slave address, there always is a control byte holding the information Data(1) or Command(0) and the continuation bit. If the continuation bit is set to 0, the following bytes are data bytes until the next stop condition occurs. The maximum clock rate for I²C bus is 400 kHz.

Please be informed, that the pins SDA+SCK contain an internal resistance of 600 to 1000 Ohm, or even more (Important, because of the LO-level while reading data and the ACK-Bit).

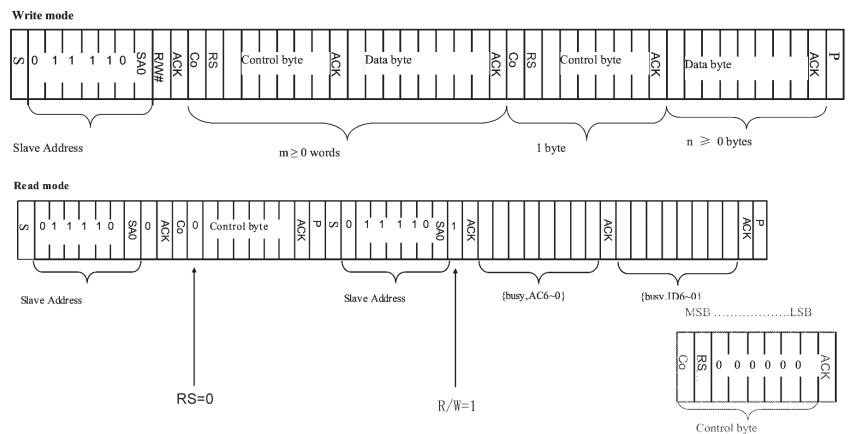

Further information about the interfaces and the timing of the SSD1803A, please refer to the datasheet http://www.lcd-module.de/fileadmin/eng/pdf/zubehoer/ssd1803a_2_0.pdf

DIMENSION

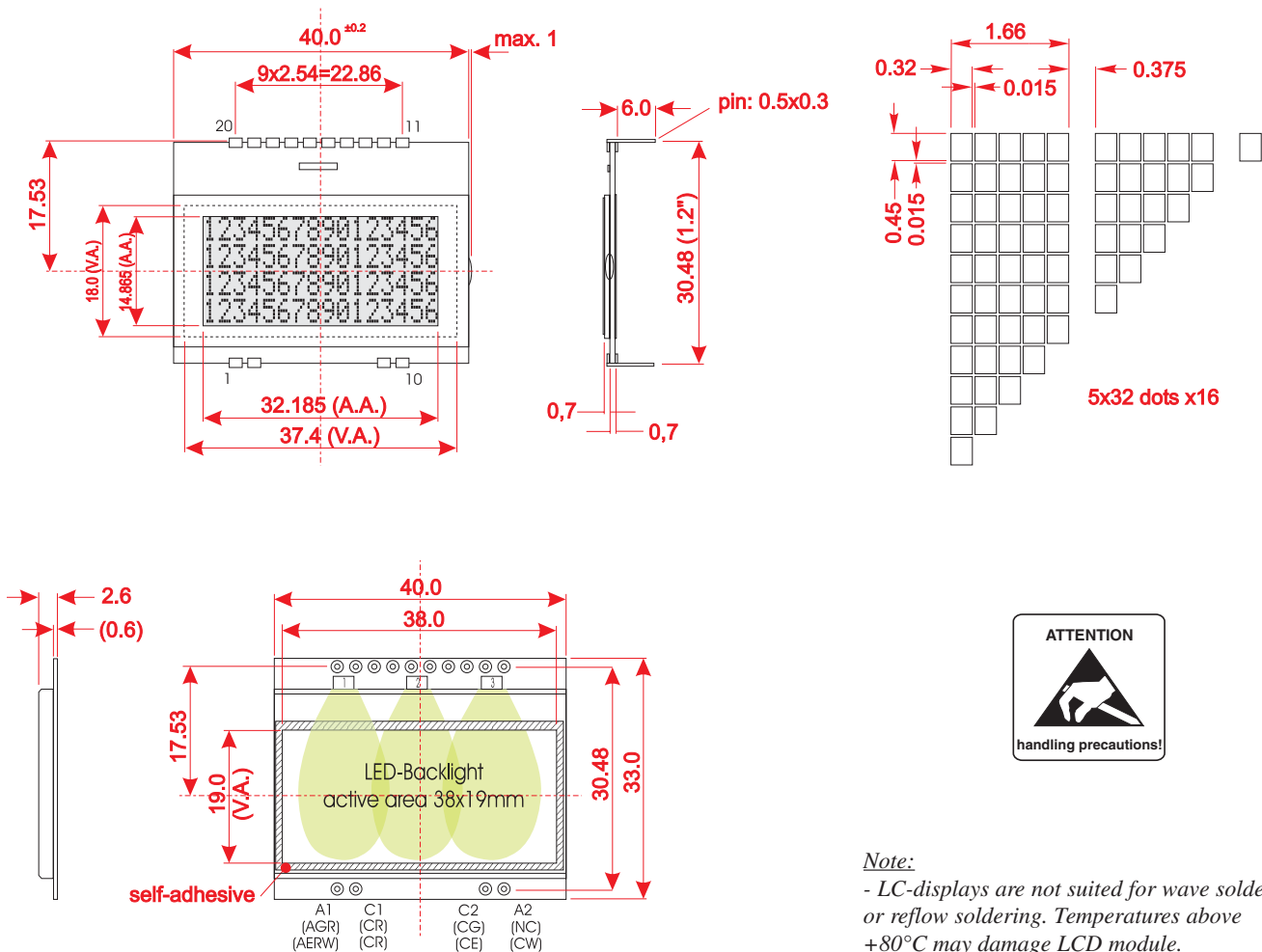

Note:

- LC-displays are not suited for wave soldering or reflow soldering. Temperatures above +80°C may damage LCD module.
- Surfaces of display and backlight are equipped with protection foils to be protected against scratching. Please remove before use.

all dimensions are in mm

Pin	Symbol	Level	Function	Pin	Symbol	Level	Function
1	NC		(A1: LED backlight)	20	RST	L	Reset
2	NC		(C1: LED backlight)	19	SA0	H/L	Slave Address
3				18	CS	L	Chip Select
4				17	SCLK	H/L	Serial Clock
5				16	SID	H/L	Serial Data In
6				15	SOD	H/L	Serial Data Out
7				14	VSS	L	GND
8				13	VDD	H	Power Supply +2.4..+3,6V
9	NC		(C2: LED backlight)	12	IM1	H/L	Mode H: SPI/ L: PC
10	NC		(A2: LED backlight)	11	VOUT	-	Output Voltage Converter

Note: The LED-Pins A1, C1, A2 und C2 (bzw. AGR, AERW, CG, CE, CR, CW) must be soldered from the top to ensure a clean contact.