

Alle Rechte vorbehalten/ All rights reserved

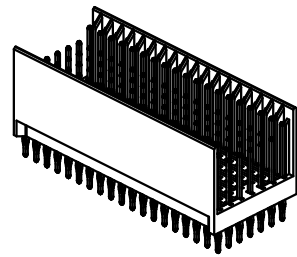

**Lochbild
board drillings**

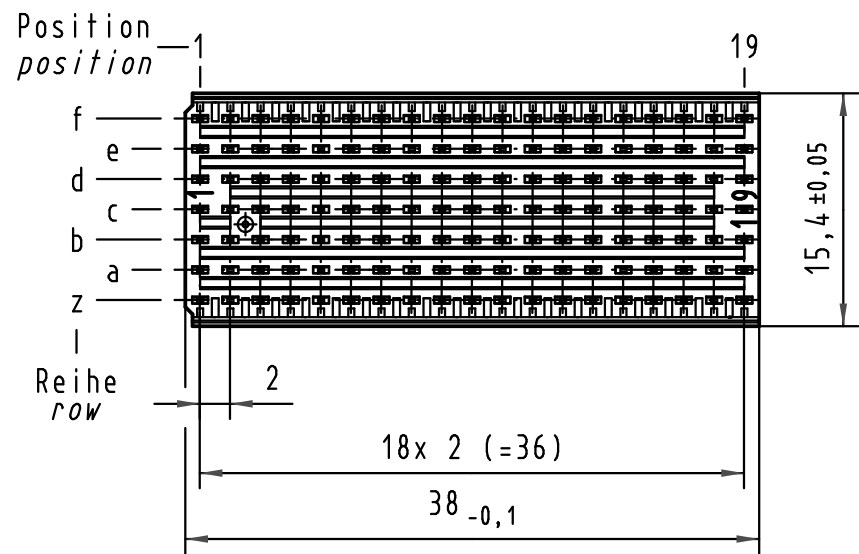
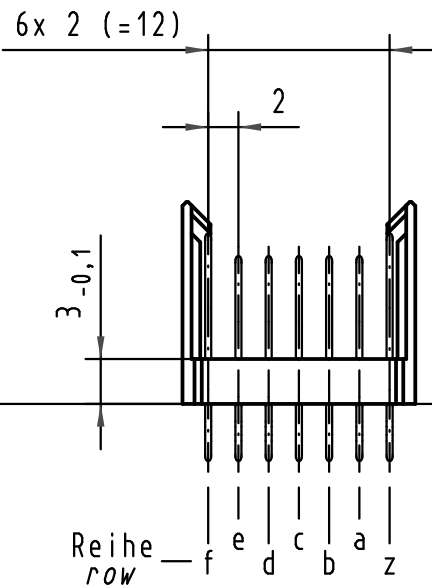
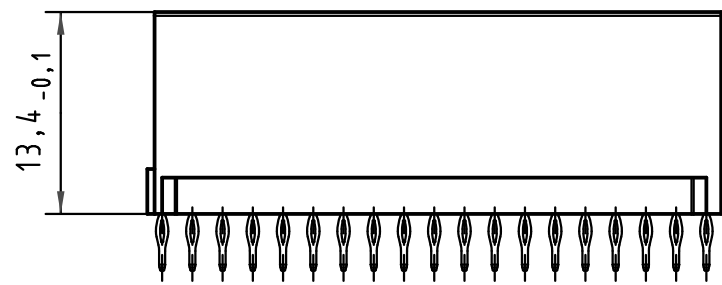
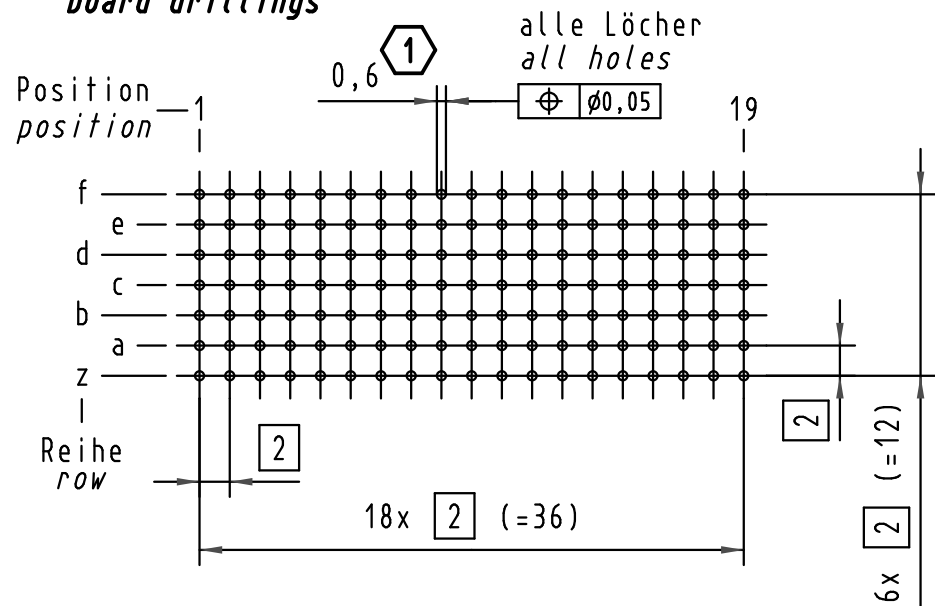

**Kontakt-Maße
contact dimensions**

(Längen der Steck- und Anschlußseite gelten für eingepreßte Steckverbinder)
(mating and termination length of contacts apply to pressed in connectors)

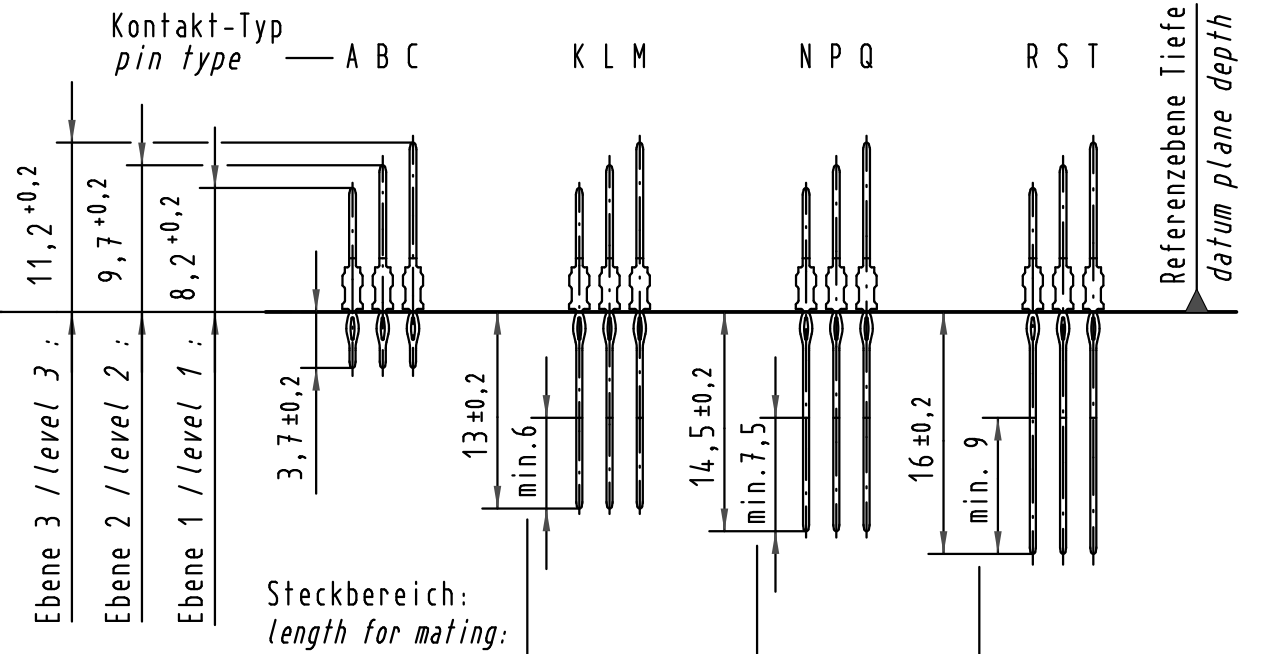

**Kontaktbelegung
contact loading**

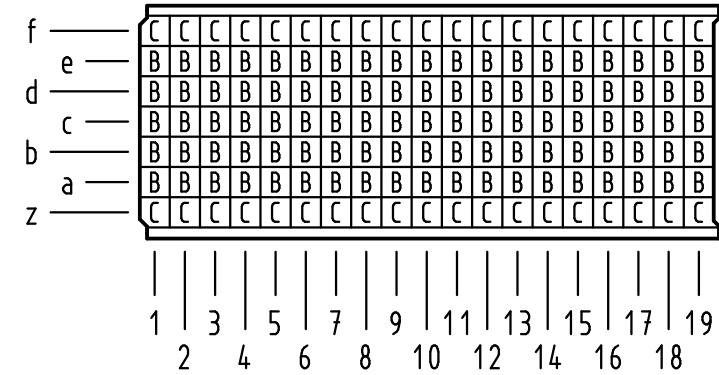

1 **Empfohlener Lochaufbau und weitere Informationen siehe: DS 17 00 110 0101**
recommended configuration of plated through holes and further information see: DS 17 00 110 0101

17 05 133 4203	S4
17 05 133 2203	2
17 05 133 1203	1
Bestell-Nr. part-no.	Anforderungsstufe performance level 1

All Dimensions in mm Original Size DIN A 3		Techn. Character.		
Mod.	Dat.	Name	Dat.	Name
35967	08.01.10	Hage.	Detail.	27.08.98 HL.
35560	21.08.09	Hage.	Insp.	27.08.98 Wei.
34337	22.05.07	Clä	Stand.	
29392	08.03.01	Rie.		
24109				
HARTING Electronics GmbH & Co. KG D-32339 ESPELKAMP				

Nicht tolerierte Maßel/Free size tolerances IEC 61076-4-101	
har-bus HM Messerleiste Typ B-19 133pol., Anschlußlänge 3,7mm har-bus HM male connector type B-19 133pol., termination length 3,7mm	
TB 17 05 133 x203	Blatt/page
Sub.	