

TNC ATTENUATOR
6 DB 3 GHZ 50W

R417.206.120
Series : ATTENUATOR

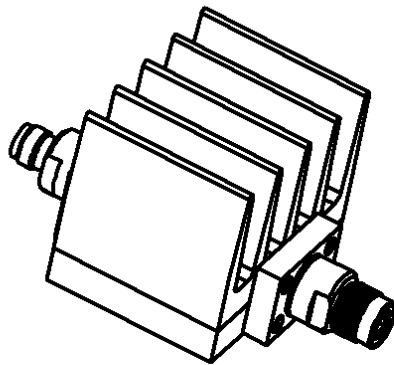

All dimensions are in mm.

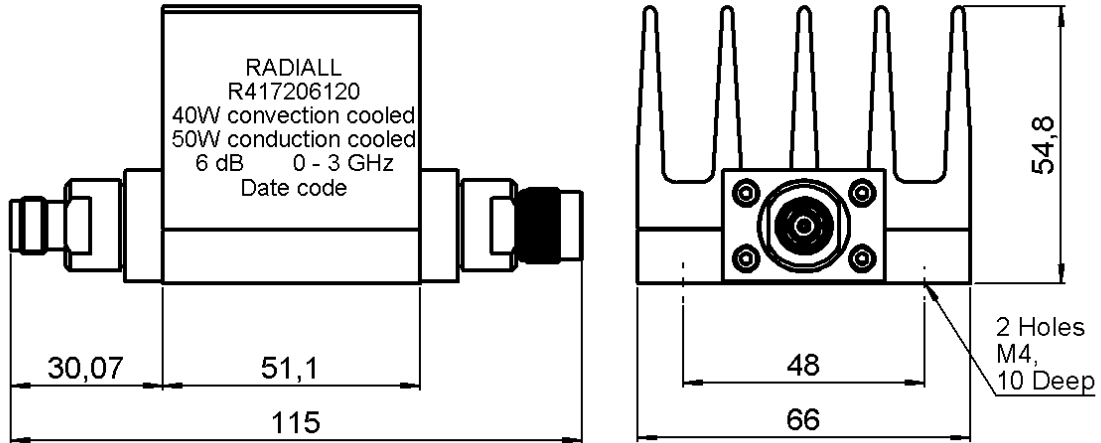

COMPONENTS	MATERIALS	PLATING(μm)
BODY	STAINLESS STEEL	PASSIVATION
MALE CENTER CONTACT	BERYLLIUM COPPER	GOLD 1.3 OVER NICKEL2
FEMALE CENTER CONTACT	BERYLLIUM COPPER	GOLD 1.3 OVER NICKEL2
OUTER CONTACT		
INSULATOR	PTFE	
GASKET	SILICONE RUBBER	
SUBSTRATE	ALUMINA	
RESISTOR	THICK FILM	
OTHERS PARTS	ALUMINIUM	BLACK PAINTING

Issue : 0842 A

In the effort to improve our products, we reserve the right to make changes judged to be necessary.



TNC ATTENUATOR
6 DB 3 GHZ 50W

R417.206.120
Series : ATTENUATOR

ELECTRICAL CHARACTERISTICS

Frequency (GHz)	DC - 1	1 - 2	2 - 3
V.S.W.R (≤)	1.10	1.25	1.35
Deviation(±dB)	0.7	0.7	0.7

Operating Frequency Range	DC - 3	GHz
Impedance	50	Ω
Nominal Attenuation	6	dB
Peak power at 25°C (1μs, 1%)	5000	W
Average power at 25°C	40	W (Free Air Cooled)
	50	W (Conduction Cooled)
For conduction cooling, a plate 500 cm ² x 3 mm(78 sq.in*1/8) min. is required		

MECHANICAL CHARACTERISTICS

Connectors	TNC	Male Female	MIL-C 39012
Weight	354,4300 g		

ENVIRONMENTAL CHARACTERISTICS

Operating temperature range	-55 /+125 °C
Storage temperature range	-55 /+125 °C



SPECIFICATION

OTHER CHARACTERISTICS

Issue : 0842 A

In the effort to improve our products, we reserve the right to make changes judged to be necessary.

