

LXP-W

~40° wide beam optimized for CREE XP-E. 14.7 mm high assembly with installation tape.

TECHNICAL SPECIFICATIONS:

Dimensions	Ø 21.6 mm
Height	14.7 mm
Fastening	tape
ROHS compliant	yes ⓘ

MATERIAL SPECIFICATIONS:

Component	Type	Material	Colour	Finish
LR1-W	Single lens	PMMA	clear	
LXP-LH1-TAPE-BLK	Holder	PC	black	
LEILA-TAPE	Tape	PU tape	black	



ORDERING INFORMATION:

Component		Qty in box	MOQ	MPQ	Box weight (kg)
FA10832_LXP-W	Single lens	2304	288	144	11.8
» Box size:					

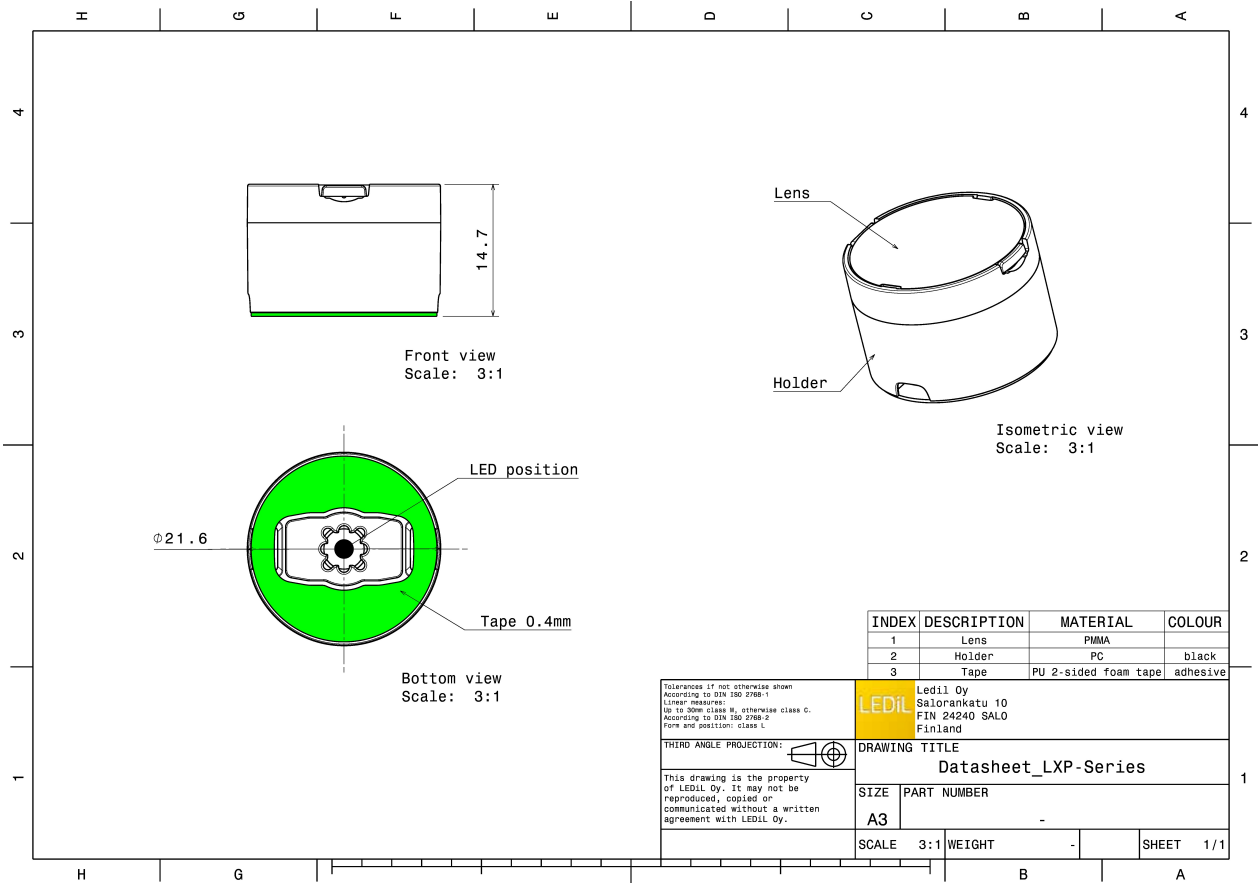

PHOTOMETRIC DATA (MEASURED):

CREE

LED XP-E
FWHM 44.0°
Efficiency 91 %
Peak intensity 1.8 cd/lm
LEDs/each optic 1
Light colour White
Required components:

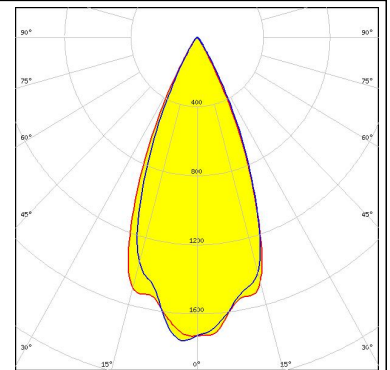

CREE

LED XP-E-HEW
FWHM 44.0°
Efficiency %
LEDs/each optic 1
Light colour White
Required components:

CREE

LED XP-G
FWHM 43.0°
Efficiency 88 %
Peak intensity 1.7 cd/lm
LEDs/each optic 1
Light colour White
Required components:

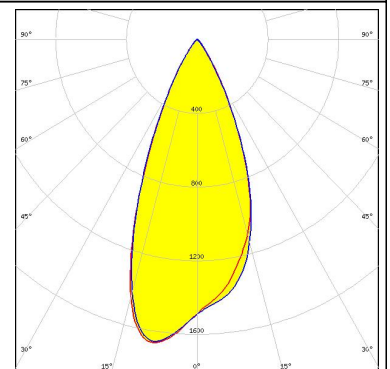
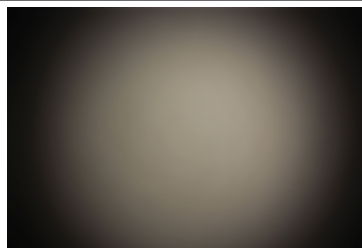

CREE

LED XP-L HI
FWHM 45.0°
Efficiency 85 %
Peak intensity 1.5 cd/lm
LEDs/each optic 1
Light colour White
Required components:

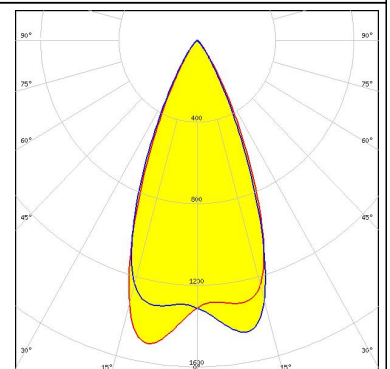
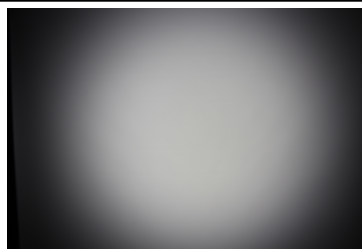

PHOTOMETRIC DATA (MEASURED):



LED XT-E
FWHM 45.0°
Efficiency %
LEDs/each optic 1
Light colour White
Required components:



Opto Semiconductors

LED OSLOM Square CSSRM2/CSSRM3
FWHM 44.0°
Efficiency 88 %
Peak intensity 1.8 cd/lm
LEDs/each optic 1
Light colour White
Required components:

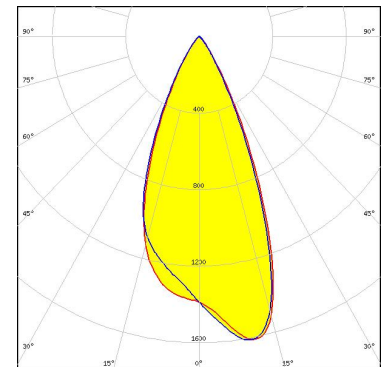
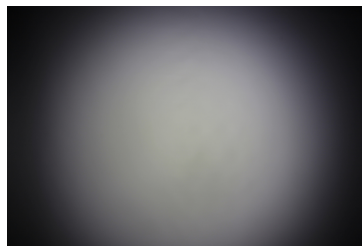

SEOUL SEMICONDUCTOR

LED Z5
FWHM 44.0°
Efficiency %
LEDs/each optic 1
Light colour White
Required components:

PHOTOMETRIC DATA (SIMULATED):



LED XP-G3
FWHM 45.0°
Efficiency 87 %
Peak intensity 1.4 cd/lm
LEDs/each optic 1
Light colour White
Required components:

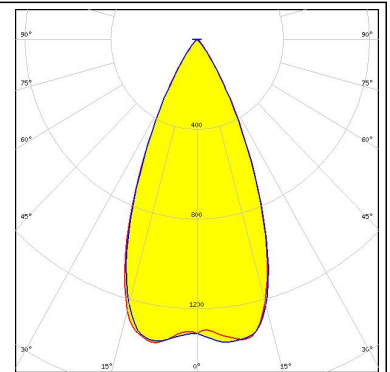

LED LUXEON V2
FWHM 45.0°
Efficiency 93 %
Peak intensity 1.5 cd/lm
LEDs/each optic 1
Light colour White
Required components:

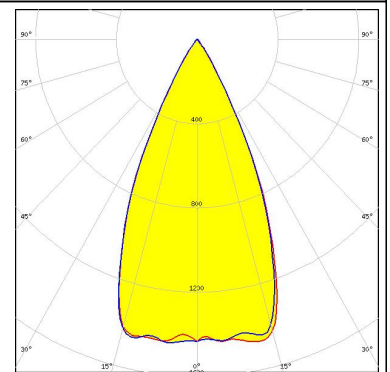

GENERAL INFORMATION:

NOTE: The typical beam angle will be changed by different color, chip size and chip position tolerance. The typical total beam angle is the full angle measured where the luminous intensity is half of the peak value.

MATERIALS:

As part of our continuous research and improvement processes, and to ensure the best possible quality and availability of our products, LEDiL reserves the right to change material grades without notice.

PRODUCT DATA USER AGREEMENT AND DISCLAIMER:

The measured data in the provided downloadable LEDiL Product Datasheets and Mechanical 2D-Drawings is rounded and provided as reference for planning. LEDiL Oy's optical specifications have been verified by conducting performance testing of the products in accordance with the company's quality system. The reported data are averaged results of multiple measurements with typical variation. LEDiL Oy reserves the right to without prior notification make changes and improvements to its products.

LEDiL Oy assumes neither warranty, nor guarantee nor any other liability of any kind for the contents and correctness of the provided data. The provided data has been generated with highest diligence but the provided data may in reality not represent the complete possible variation range of all intrinsic parameters. Therefore, in certain cases a deviation from the provided data could occur.

LEDiL Oy reserves the right to undertake technical changes of its products without further notification which could lead to changes in the provided data. LEDiL Oy assumes no liability of any kind for the possible deviation from any provided data or any other damage resulting from the usage of the provided data.

The user agrees to this disclaimer and user agreement with the download or usage of the provided files.

LEDiL Oy

Joensuunkatu 13
FI-24240 SALO
Finland

LEDiL Inc.

228 West Page Street
Suite D
Sycamore IL 60178
USA

Local sales and technical support

[www.ledil.com/
where_to_buy](http://www.ledil.com/where_to_buy)

Shipping locations

Salo, Finland
Hong Kong, China

Distribution Partners

[www.ledil.com/
where_to_buy](http://www.ledil.com/where_to_buy)