

spec ref	-	dr	Andy Lu	2015-12-24	projection	MM	size	A2	scale	4:1	
tolerance std	ISO 406 ISO 1101	eng	Andy Lu	2018-03-07			ecn no	-	In Work		
TOLERANCES UNLESS OTHERWISE SPECIFIED		chr	Fancy Zhang	2018-03-07			rel level	-			
surface	ISO 1302	appr	PM Zheng	2018-03-07	product family	CARD EDGE	rel level	-	In Work		
	linear	Amphenol FCI			title	eHPCE STRADDLE MOUNT		dwg no	10137755	rev	5
	angular				(UP+MP+S) - UNIVERSAL DRAWING		cat. no.	Product - Customer Drw		sheet 1 of 5	
		linear	0.X	±0.5							
			0.XX	±0.25							
			0.XXX	±0.13							
		angular	0°	±2°							

Amphenol FCI

© 2016 APCI

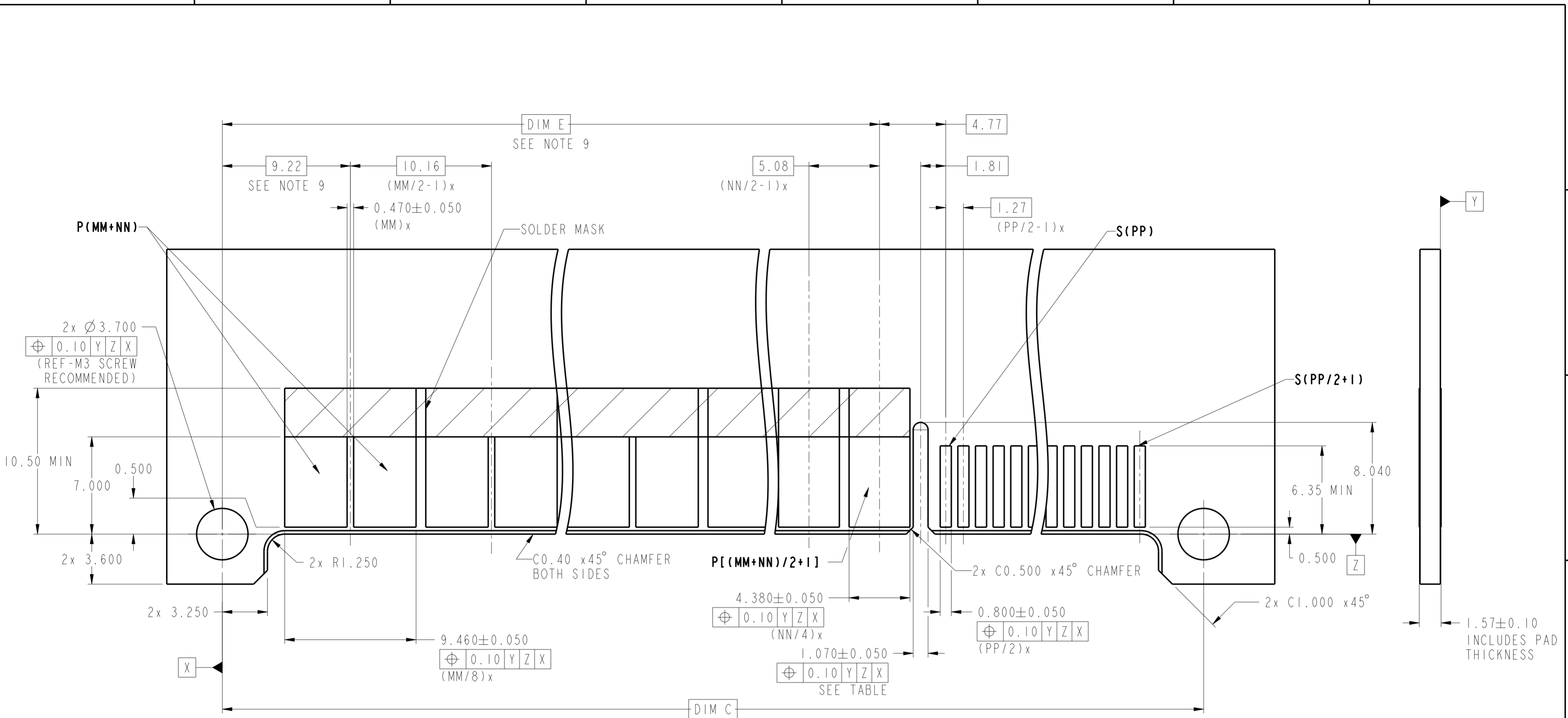

**RECOMMENDED HOST BOARD LAYOUT
TOLERANCE ±0.05**

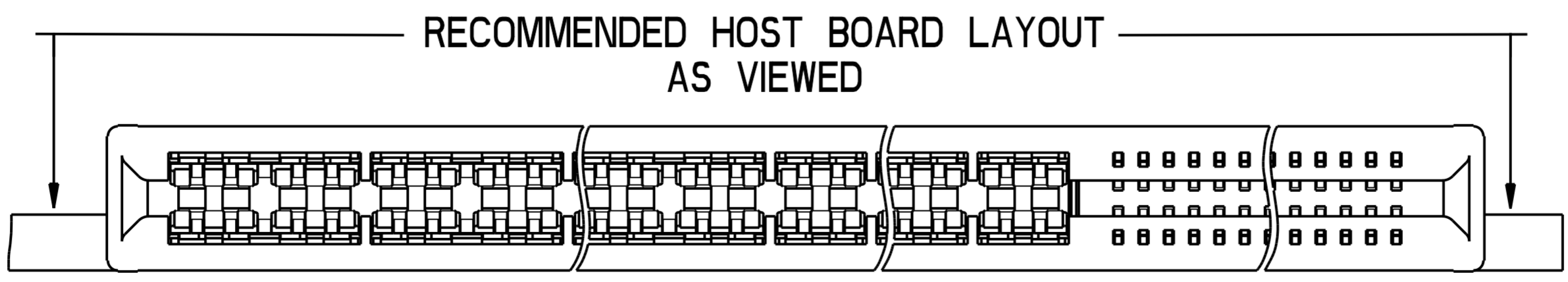

spec ref	-	dr	Andy Lu	2015-12-24	projection	MM	size	A2	scale	2:1
tolerance std	ISO 406 ISO 1101	eng	Andy Lu	2018-03-07			ecn no	-	In Work	rev 5
TOLERANCES UNLESS OTHERWISE SPECIFIED		chr	Fancy Zhang	2018-03-07			rel level	-		
surface	ISO 1302	appr	PM Zheng	2018-03-07	product family	-	cat. no.	-	Product - Customer Drw	sheet 2 of 5
linear	0.X ±0.5 0.XX ±0.25 0.XXX ±0.13	Amphenol FCI		title eHPCE STRADDLE MOUNT (UP+MP+S) - UNIVERSAL DRAWING		dwg no	10137755			
angular	0° ±2°									

Amphenol FCI

© 2016 APCI

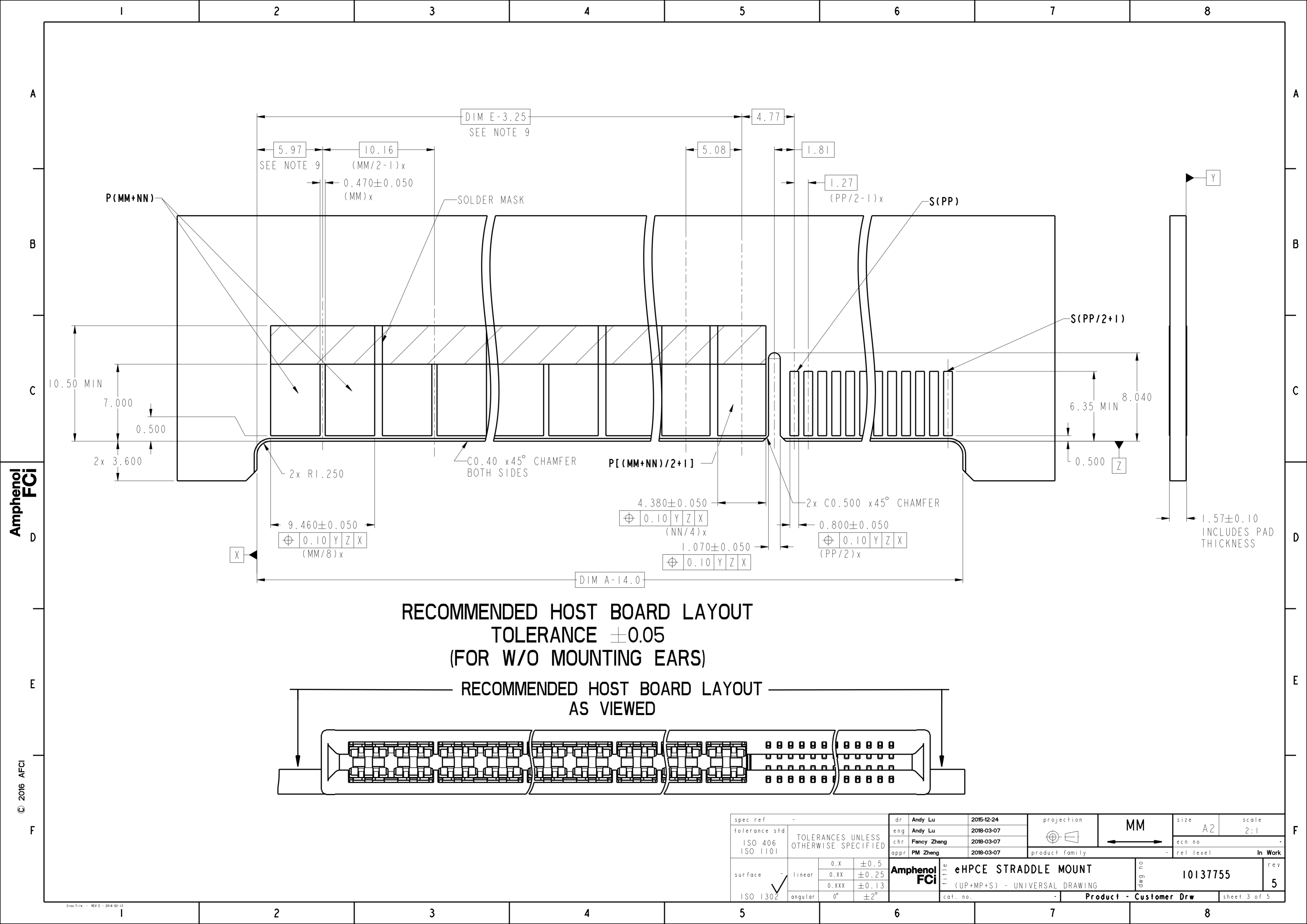

Amphenol
FCi

© 2016 AFci

RECOMMENDED HOST BOARD LAYOUT
TOLERANCE ±0.05
(FOR W/O MOUNTING EARS)

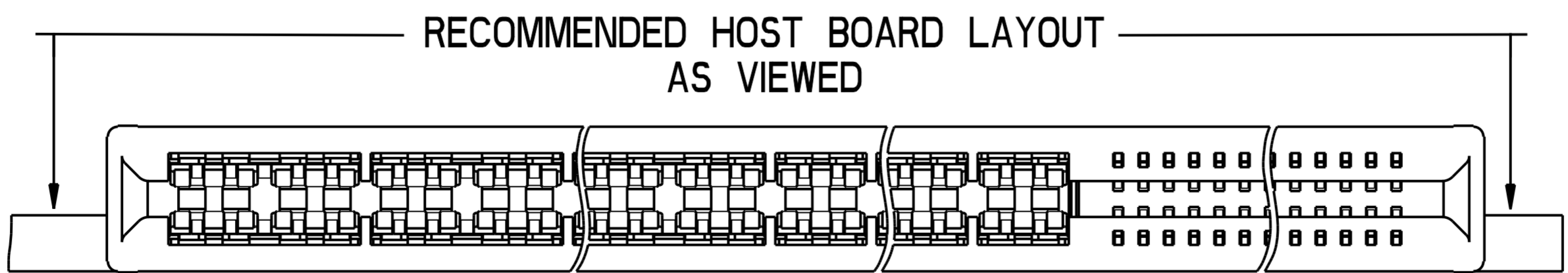

spec ref	-	dr	Andy Lu	2015-12-24	projection	MM	size	A2	scale	2:1
tolerance std	ISO 406 ISO 1101	eng	Andy Lu	2018-03-07			ecn no	rel level	In Work	rev
TOLERANCES UNLESS OTHERWISE SPECIFIED		chr	Fancy Zhang	2018-03-07						
surface	ISO 1302	appr	PM Zheng	2018-03-07	product family	-	10137755	5		
linear	0.X ±0.5 0.XX ±0.25 0.XXX ±0.13	Amphenol FCi		title		eHPCE STRADDLE MOUNT (UP+MP+S) - UNIVERSAL DRAWING		cat. no.		Product - Customer Drw
angular	0° ±2°									sheet 3 of 5

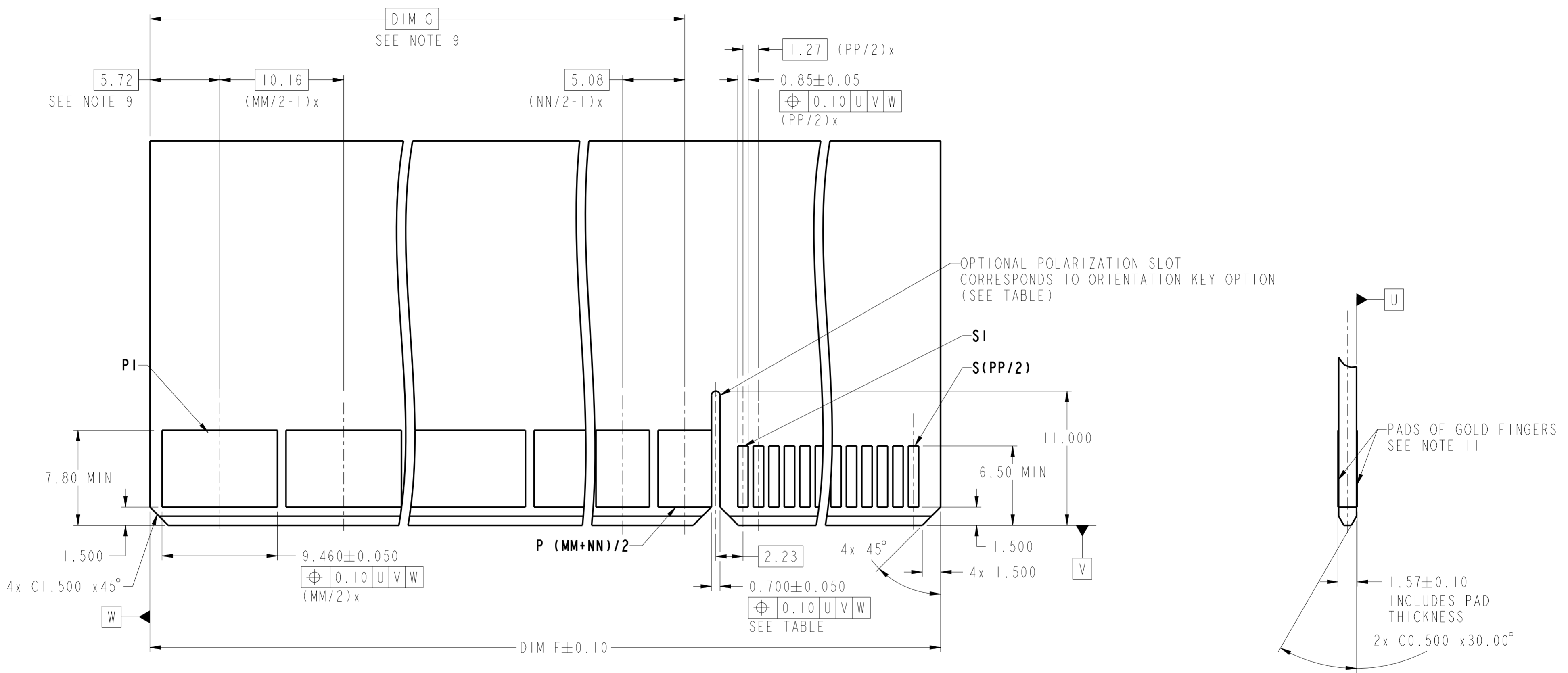

RECOMMENDED MATING BOARD LAYOUT
TOLERANCE ±0.05

Amphenol
FCi

© 2016 AFci

spec ref	-	dr	Andy Lu	2015-12-24	projection	MM	size	A2	scale	1:1	
tolerance std	ISO 406 ISO 1101	eng	Andy Lu	2018-03-07			ecn no	-	rel level	In Work	
TOLERANCES UNLESS OTHERWISE SPECIFIED		chr	Fancy Zhang	2018-03-07							
surface	ISO 1302	appr	PM Zheng	2018-03-07	product family	-	rel level	-	In Work		
linear	0.X ±0.5 0.XX ±0.25 0.XXX ±0.13	Amphenol FCi		title		eHPCE STRADDLE MOUNT (UP+MP+S) - UNIVERSAL DRAWING		dwg no	10137755	rev	5
angular	0° ±2°	cat. no.		Product - Customer Drw		sheet 4 of 5					

10137755 - MM NN PP LF

LEAD FREE

	A	B	C	D	E	F	G	H
MOUNTING EARS	Y	Y	Y	N	N	N	Y	N
POLARIZATION KEY	Y	N	N	Y	N	N	Y	Y
REAR GUIDE	Y	Y	N	Y	Y	N	N	N

ULTRA PWR CONTACT QTY
(NEXT TO LEFT END)

MIDDLE PWR CONTACT QTY
(NEXT TO SIGNAL)

SIGNAL CONTACT QTY

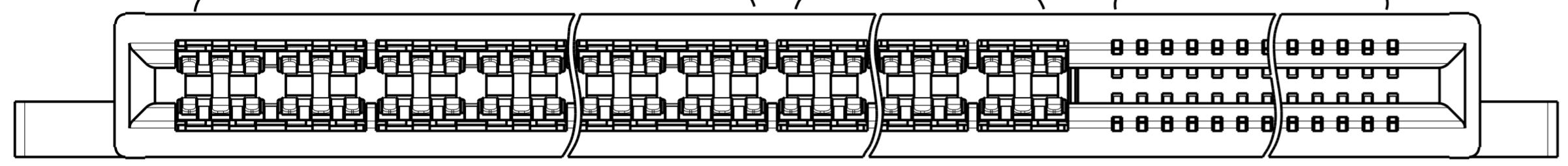

Example: The configuration above is 10137755-060624ALF
STRADDLE MOUNT WITH ENHANCED WALLS 6UP6MP24S WITH MOUNTING EARS,
POLARIZATION KEY AND ALIGNMENT KEY.

6UP means 6 pcs ultra power contacts with 6 beams; 24S means 24 pcs signal contacts;
6MP means 6 pcs middle power contacts with 3 beams.

TABLE: PART NUMBER CODE FOR eHPCE STRADDLE MOUNT WITH ENHANCED WALL UP+MP+S CONFIG

NOTES:

- CONNECTOR MATERIALS:
HOUSING: HIGH TEMPERATURE THERMAL PLASTIC, BLACK, LOW HALOGEN, UL 94V-0
CONTACTS: HIGH PERFORMANCE COPPER ALLOY.
- CONTACT FINISH REF. SECTION 5.2 IN PRODUCT SPECIFICATION.
- PRODUCT SPECIFICATION: GS-12-1362.
- APPLICATION SPECIFICATION: GS-20-0469.
- PRODUCT MARKING (PART NUMBER & DATE CODE) ON HOUSING IN AREA SHOWN.
- PACKAGING MEETS SPECIFICATION GS-14-2532(POCKET TRAY).
- HOUSING COMPONENT WILL WITHSTAND EXPOSURE TO 260°C PEAK TEMPERATURE FOR 10 SECONDS IN A CONVECTION, INFRA-RED, OR VAPOR PHASE REFLOW OVEN.
- MAXIMUM OVERALL LENGTH IS 100mm.
- DIM IS NOT APPLICABLE IF THERE ISN'T 3 BEAMS CONTACT.
- THIS PRODUCT MEETS EUROPEAN UNION DERECTIVES AND OTHER COUNTRY REGULATIONS AS DESCRIBED IN GS-47-0004.
- PLATING OF PADS SHALL BE 30u" GOLD MINIMUM OVER 50u" NICKEL MINIMUM. SURFACE MUST BE FREE OF FOREIGN MATTER.

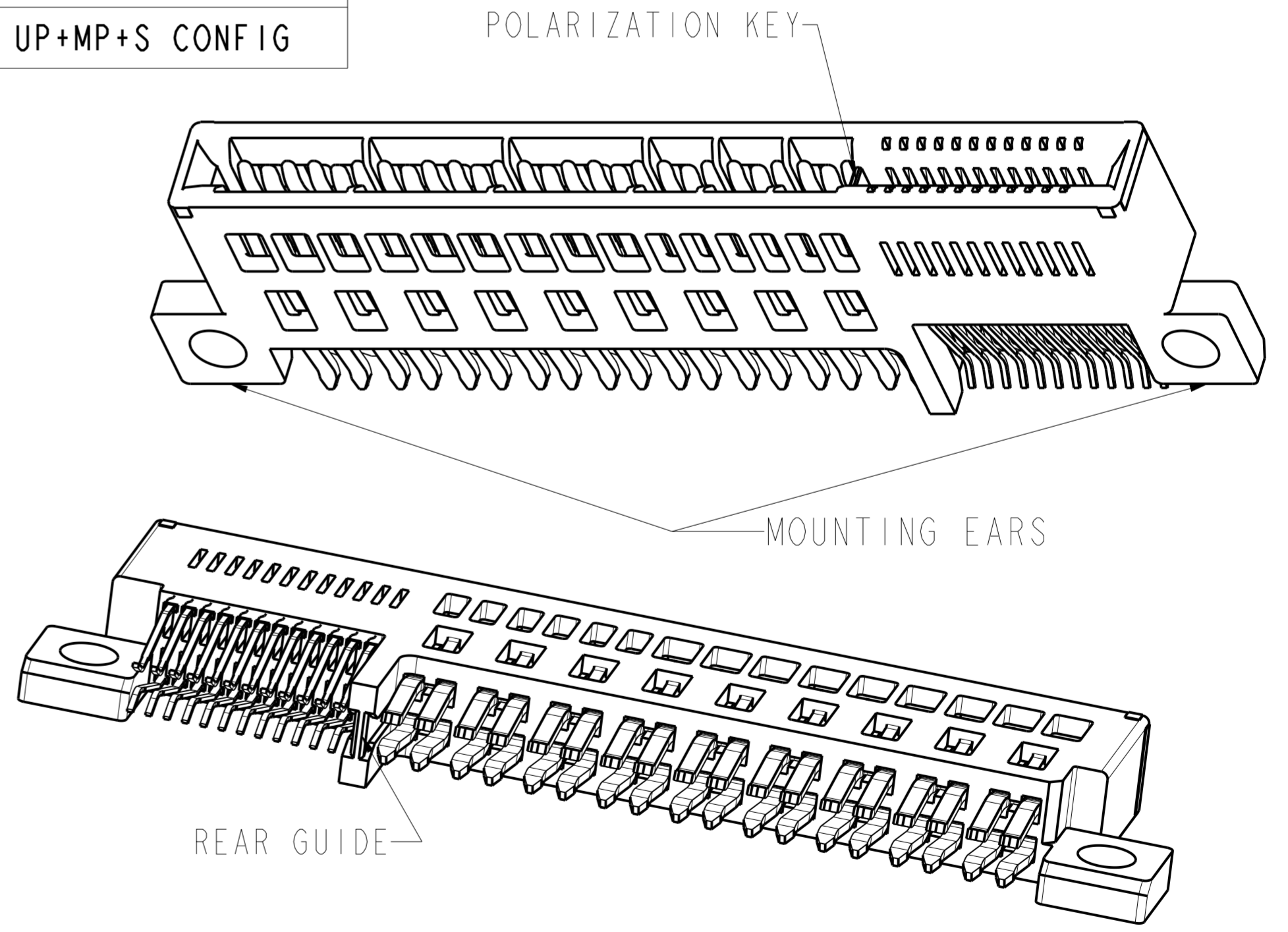

DIM	TABLE 2. LENGTH FORMULAS
DIM A ⑧	$(MM/2)*10.16 + (NN/2) \times 5.08 + (PP/2) \times 1.27 + 17.20$
DIM B	DIM A - 13.08
DIM C	DIM A - 7.50
DIM D	DIM A - 8.98
DIM E ⑨	$(MM/2 - 1) \times 10.16 + (NN/2 - 1) \times 5.08 + 16.84$ (WITH UP CONTACT) $(NN/2 - 1) \times 5.08 + 6.68$ (WITHOUT UP CONTACT)
DIM F	DIM A - 13.38
DIM G ⑨	$(MM/2 - 1) \times 10.16 + (NN/2 - 1) \times 5.08 + 13.34$ (WITH UP CONTACT) $(NN/2 - 1) \times 5.08 + 3.18$ (WITHOUT UP CONTACT)

spec ref	-	dr	Andy Lu	2015-12-24	projection	MM	size	A2	scale	4:1
tolerance std	ISO 406 ISO 1101	eng	Andy Lu	2018-03-07		CARD EDGE	ecn no	-	rel level	In Work
surface	linear ISO 1302	chr	Fancy Zhang	2018-03-07			cat. no.	-		
	angular	appr	PM Zheng	2018-03-07	product family	eHPCE STRADDLE MOUNT (UP+MP+S) - UNIVERSAL DRAWING	dwg no	10137755	rev	5
							Product - Customer Drw		sheet 5 of 5	

Amphenol FCI

© 2016 AFCI