

FEATURES

- RF output frequency range: 62.5 MHz to 32,000 MHz**
- Fractional-N synthesizer and Integer N synthesizer**
- High resolution 39-bit fractional modulus**
- Typical spurious PFD: -90 dBc**
- Integrated rms jitter: 38 fs (1 kHz to 100 MHz)**
- Normalized phase noise floor: -234 dBc/Hz**
- PFD operation to 250 MHz**
- Reference frequency operation to 600 MHz**
- Programmable divide by 1, 2, 4, 8, 16, 32, or 64 output**
- 62.5 MHz to 8,000 MHz output at RF8x and RFAUX8x**
- 8,000 MHz to 16,000 MHz output at RF16x**
- 16,000 MHz to 32,000 MHz output at RF32x**
- Lock time approximately 3 ms with automatic calibration**
- Lock time <30 μs with autocalibration bypassed**
- Analog and digital power supplies: 3.3 V**
- VCO power supply: 3.3 V and 5 V**
- RF output mute function**
- 7mm × 7mm, 48-terminal LGA package**

APPLICATIONS

- Wireless infrastructure (multicarrier global system for mobile communication (MC-GSM), 5 G)**
- Test equipment and instrumentation**
- Clock generation**
- Aerospace and defense**

GENERAL DESCRIPTION

The ADF4371 allows implementation of fractional-N or Integer N phase-locked loop (PLL) frequency synthesizers when used with an external loop filter and an external reference frequency. The wideband microwave voltage controlled oscillator (VCO) design allows frequencies from 62.5 MHz to 32 GHz to be generated.

The ADF4371 has an integrated VCO with a fundamental output frequency ranging from 4000 MHz to 8000 MHz. In addition, the VCO frequency is connected to divide by 1, 2, 4, 8, 16, 32, or 64 circuits that allows the user to generate radio frequency (RF) output frequencies as low as 62.5 MHz at RF8x. A frequency multiplier at RF16x generates from 8 GHz to 16 GHz. A frequency quadrupler generates frequencies from 16 GHz to 32 GHz at RF32x. RFAUX8x duplicates the frequency range of RF8x or permits direct access to the VCO output. To suppress the unwanted products of frequency multiplication, a harmonic filter exists between the multipliers and the output stages of RF16x and RF32x.

Control of all on-chip registers is through a 3-wire interface. The ADF4371 operates with analog and digital power supplies ranging from 3.15 V to 3.45 V, and 5 V for the VCO power supply. The ADF4371 also contains hardware and software power-down modes.

FUNCTIONAL BLOCK DIAGRAM

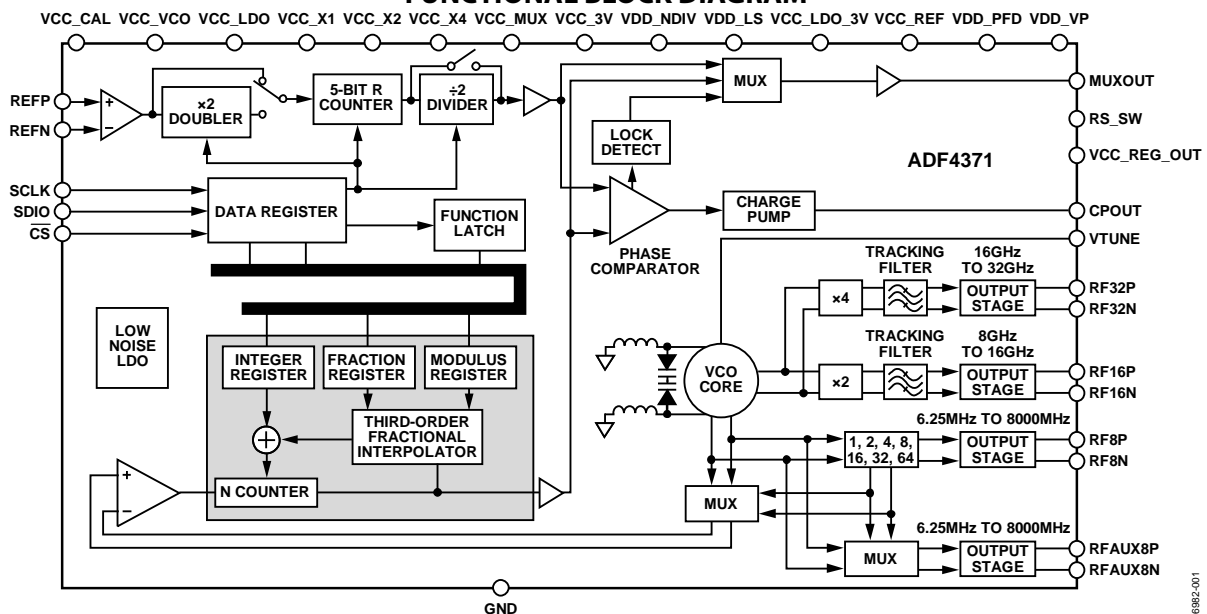

Figure 1.

Rev. 0

[Document Feedback](#)

Information furnished by Analog Devices is believed to be accurate and reliable. However, no responsibility is assumed by Analog Devices for its use, nor for any infringements of patents or other rights of third parties that may result from its use. Specifications subject to change without notice. No license is granted by implication or otherwise under any patent or patent rights of Analog Devices. Trademarks and registered trademarks are the property of their respective owners.

One Technology Way, P.O. Box 9106, Norwood, MA 02062-9106, U.S.A.
Tel: 781.329.4700 ©2019 Analog Devices, Inc. All rights reserved.
[Technical Support](#) www.analog.com

TABLE OF CONTENTS

| | | | |
|--|----|--|----|
| Features | 1 | RF N Divider..... | 19 |
| Applications..... | 1 | PFD and Charge Pump..... | 20 |
| General Description | 1 | MUXOUT and Lock Detect..... | 20 |
| Revision History | 2 | Double Buffers..... | 20 |
| Functional Block Diagram | 1 | VCO | 20 |
| Specifications..... | 3 | Output Stage..... | 21 |
| Timing Specifications | 7 | Doubler | 21 |
| Absolute Maximum Ratings..... | 8 | Quadrupler..... | 22 |
| Thermal Resistance | 8 | Output Stage Mute | 22 |
| ESD Caution..... | 8 | SPI..... | 22 |
| Pin Configuration and Function Descriptions..... | 9 | Device Setup..... | 23 |
| Typical Performance Characteristics | 11 | Step 1: Set Up the SPI Interface | 23 |
| Theory of Operation | 16 | Step 2: Initialization Sequence..... | 23 |
| RF Synthesizer, a Worked Example..... | 16 | Step 3: Frequency Update Sequence | 23 |
| Reference Input Sensitivity..... | 16 | Applications Information | 24 |
| Reference Doubler and Reference Divider | 17 | Power Supplies..... | 24 |
| Spurious Optimization and Fast Lock..... | 17 | PCB Design Guidelines for an LGA Package | 24 |
| Optimizing Jitter | 17 | Output Matching | 24 |
| Spur Mechanisms | 17 | Register Summary | 25 |
| Lock Time..... | 17 | Register Details | 27 |
| Circuit Description..... | 19 | Outline Dimensions | 48 |
| Reference Input..... | 19 | Ordering Guide | 48 |

REVISION HISTORY

1/2019—Revision 0: Initial Version

SPECIFICATIONS

4.75 V ≤ VCC_VCO ≤ 5.25 V, all other supply pins (AV_{DD}) = 3.3 V ± 5%, GND = 0 V, dBm referred to 50 Ω, T_A = whole operating temperature range, unless otherwise noted.

Table 1.

| Parameter | Symbol | Min | Typ | Max | Unit | Test Conditions/Comments |
|--------------------------------------|------------------------------------|------------------------|-------|------------------|-------|--|
| REFP AND REFN CHARACTERISTICS | | | | | | |
| Input Frequency | | | | | | |
| Single-Ended Mode | | 10 | | 500 | MHz | Doubler disabled |
| Differential Mode | | 10 | | 600 | MHz | Doubler disabled |
| Single-Ended or Differential Mode | | 10 | | 125 | MHz | Doubler enabled |
| Input Sensitivity | | | | | | |
| Single-Ended Mode | | 0.4 | | AV _{DD} | V p-p | REFP biased at AV _{DD} /2, ac coupling ensures AV _{DD} /2 bias |
| Differential Mode | | 0.4 | | 1.8 | V p-p | Low voltage differential signal (LVDS) and low voltage positive emitter coupled logic (LVPECL) compatible, REFP and REFN biased at 2.1 V, ac coupling ensures 2.1 V bias |
| Input Capacitance | | | | | | |
| Single-Ended Mode | | | 6.9 | | pF | |
| Differential Mode | | | 1.4 | | pF | |
| Input Current | | | | ±150 | μA | Single-ended reference programmed |
| | | | | 300 | μA | Differential reference programmed |
| Phase Detector Frequency | | | | 160 | MHz | Fractional mode |
| | | | | 250 | MHz | Integer mode |
| CHARGE PUMP | | | | | | |
| Charge Pump Current, Sink and Source | I _{CP} | | | | | |
| High Value | | | 5.6 | | mA | |
| Low Value | | | 0.35 | | mA | |
| Current Matching | | | 3 | | % | 0.5 V ≤ voltage at the CPOUT pin (V _{CP}) ≤ VDD_VP – 0.5 V |
| I _{CP} vs. V _{CP} | | | 3 | | % | 0.5 V ≤ V _{CP} ≤ VDD_VP – 0.5 V |
| I _{CP} vs. Temperature | | | 1.5 | | % | V _{CP} = 2.5 V |
| LOGIC INPUTS | | | | | | |
| Input High Voltage | V _{INH} | 1.17 | | | V | CS, SDIO, SCLK, and CE is 3 V logic |
| Input Low Voltage | V _{INL} | | | 0.63 | V | |
| Input Current | I _{INH} /I _{INL} | | | ±1 | μA | |
| Input Capacitance | C _{IN} | | 3.0 | | pF | |
| LOGIC OUTPUTS | | | | | | |
| Output High Voltage | V _{OH} | AV _{DD} – 0.4 | | | V | 3.3 V output selected |
| | | 1.5 | 1.875 | | V | 1.8 V output selected |
| Output High Current | I _{OH} | | | 500 | μA | |
| Output Low Voltage | V _{OL} | | | 0.4 | V | Output low current (I _{OL}) = 500 μA |

| Parameter | Symbol | Min | Typ | Max | Unit | Test Conditions/Comments |
|--|------------------|-------|------|-------|-------|--|
| POWER SUPPLIES | | | | | | |
| Supply Voltage (except VCO) ¹ | AV _{DD} | 3.15 | | 3.45 | V | VCC_CAL, VCC_X4, VDD_X4, VCC_X1, VDD_X1, VCC_X2, VCC_MUX, VCC_3V, VDD_NDIV, VDD_LS, VCC_LDO_3V, VCC_REF, VDD_PFD, VDD_VP are grouped as AV _{DD} , and are at the same voltage |
| Supply Voltage (except VCO) | AI _{DD} | | 190 | 260 | mA | All outputs are disabled |
| Output Dividers | | | | | | |
| Divider = 2 | | | 14 | 20 | mA | Each divide by 2 will consume additional typical 7 mA current |
| Divider = 64 | | | 50 | 65 | mA | |
| VCO Supply Voltage | VCC_VCO | 3.15 | 3.3 | 3.45 | V | 3.3 V condition |
| | | 4.75 | 5 | 5.25 | V | 5 V condition |
| VCO Supply Current | I _{VCO} | | 80 | 120 | mA | 3.3 V condition |
| | | | 135 | 180 | mA | 5 V condition |
| RF8x Supply Current | | | | | | RF8P and RF8N output stage is programmable, extra current is drawn in VCC_X1 |
| | | | 25 | | mA | -4 dBm setting |
| | | | 39 | | mA | -1 dBm setting |
| | | | 52 | | mA | 2 dBm setting |
| | | | 65 | | mA | 5 dBm setting |
| RFAUX8x Supply Current | | | 42 | | mA | -4 dBm setting |
| | | | 56 | | mA | -1 dBm setting |
| | | | 70 | | mA | 2 dBm setting |
| | | | 84 | | mA | 5 dBm setting |
| RF16x Supply Current | | | 90 | 120 | mA | |
| RF32x Supply Current | | | 160 | 210 | mA | |
| Low Power Sleep Mode | | | 5.1 | 6.2 | mA | Hardware power-down 3.3 V VCO case |
| | | | 8 | 9.5 | mA | Hardware power-down 5 V VCO case |
| | | | 21.5 | 25 | mA | Software power-down 3.3 V VCO case |
| | | | 23.7 | 28 | mA | Software power-down 5 V VCO case |
| RF OUTPUT CHARACTERISTICS | | | | | | |
| VCO Frequency Range | | 4000 | | 8000 | MHz | Fundamental VCO range |
| RF8P and RF8N Output Frequency | | 62.5 | | 8000 | MHz | |
| RFAUX8P and RFAUX8N Output Frequency | | 62.5 | | 8000 | MHz | |
| RF16P and RF16N Output Frequency | | 8000 | | 16000 | MHz | 2 × VCO output |
| RF32P and RF32N Output Frequency | | 16000 | | 32000 | MHz | 4 × VCO output |
| VCO Sensitivity | K _v | | | | | |
| For 5 V | | | 80 | | MHz/V | VCO frequency = 6 GHz, see Figure 39 for K _v plot |
| For 3.3 V | | | 60 | | MHz/V | VCO frequency = 6 GHz, see Figure 40 for K _v plot |
| Frequency Pushing (Open-Loop) | | | 8 | | MHz/V | |
| Frequency Pulling (Open-Loop) | | | 0.5 | | MHz | Voltage standing wave ratio (VSWR) = 2:1 RF8P and RF8N |
| | | | 30 | | MHz | VSWR = 2:1 RF16x |
| Maintain Lock Temperature Range ² | | | | 125 | °C | Maintains lock without reprogramming device |

| Parameter | Symbol | Min | Typ | Max | Unit | Test Conditions/Comments |
|--|--------|-----|------|-----|--------|--|
| Harmonic Content | | | | | | |
| Second Harmonic RF8P and RF8N | | | -25 | | dBc | Fundamental VCO output (RF8P) |
| Third Harmonic RF8P and RF8N | | | -25 | | dBc | Divided VCO output (RF8P) |
| Second Harmonic RF16P and RF16N | | | -12 | | dBc | Fundamental VCO output (RF8P) |
| Third Harmonic RF16P and RF16N | | | -15 | | dBc | Divided VCO output (RF8P) |
| Second Harmonic RF32P and RF32N | | | -30 | | dBc | Measured at 20 GHz |
| Third Harmonic RF32P and RF32N | | | -30 | | dBc | Measured at 30 GHz |
| Fundamental VCO Feedthrough | | | -30 | | dBc | Measured at 40 GHz |
| Fundamental VCO Feedthrough | | | -62 | | dBc | Measured at 60 GHz |
| Fundamental VCO Feedthrough | | | -30 | | dBc | RF16x = 10 GHz, VCO frequency = 5 GHz |
| Fundamental VCO Feedthrough | | | -30 | | dBc | RF8P and RF8N = 1 GHz, VCO frequency = 4 GHz |
| RF Output Power Maximum Setting ³ | | | 7 | | dBm | RF8P = 4 GHz, 7.5 nH inductor to VCC_X1 |
| | | | 5 | | dBm | RF8P = 8 GHz, 7.5 nH inductor to VCC_X1 |
| | | | 0 | | dBm | RF16x = 8 GHz |
| | | | 4 | | dBm | RF16x = 16 GHz |
| | | | -1 | | dBm | RF32x = 16 GHz |
| | | | -7 | | dBm | RF32x = 32 GHz |
| RF Output Power Variation | | | ±1 | | dB | RF8P and RF8N = 5 GHz |
| | | | ±1 | | dB | RF16x = 10 GHz |
| | | | ±1 | | dB | RF32x = 20 GHz |
| RF Output Power Variation (over Frequency) | | | ±2 | | dB | RF8x and RFAUX8x = 4 GHz to 8 GHz |
| | | | ±2.5 | | dB | RF16x = 8 GHz to 16 GHz |
| | | | ±5 | | dB | RF32x = 16 GHz to 32 GHz |
| Level of Signal with RF Output Disabled | | | -50 | | dBm | RF8P and RF8N = 1 GHz |
| | | | -44 | | dBm | RF8P and RF8N = 8 GHz |
| | | | -41 | | dBm | RF8P and RF8N = 8 GHz, 5 V VCO case |
| | | | -75 | | dBm | RF16P = 8 GHz |
| | | | -55 | | dBm | RF16P = 16 GHz |
| | | | -85 | | dBm | RF32P = 16 GHz |
| | | | -70 | | dBm | RF32P = 32 GHz |
| NOISE CHARACTERISTICS | | | | | | |
| Fundamental VCO Phase Noise | | | | | | VCO noise in open-loop conditions, VCC_VCO = 5 V |
| Performance where VCC_VCO = 5 V | | | -117 | | dBc/Hz | 100 kHz offset from 4.0 GHz carrier |
| | | | -139 | | dBc/Hz | 1 MHz offset from 4.0 GHz carrier |
| | | | -156 | | dBc/Hz | 10 MHz offset from 4.0 GHz carrier |
| | | | -112 | | dBc/Hz | 100 kHz offset from 5.7 GHz carrier |
| | | | -136 | | dBc/Hz | 1 MHz offset from 5.7 GHz carrier |
| | | | -153 | | dBc/Hz | 10 MHz offset from 5.7 GHz carrier |
| | | | -109 | | dBc/Hz | 100 kHz offset from 8.0 GHz carrier |
| | | | -133 | | dBc/Hz | 1 MHz offset from 8.0 GHz carrier |
| | | | -152 | | dBc/Hz | 10 MHz offset from 8.0 GHz carrier |
| RF16x Output Phase Noise | | | | | | VCC_VCO = 5 V |
| Performance where VCC_VCO = 5 V | | | -106 | | dBc/Hz | 100 kHz offset from 11.4 GHz carrier |
| | | | -130 | | dBc/Hz | 1 MHz offset from 11.4 GHz carrier |
| | | | -146 | | dBc/Hz | 10 MHz offset from 11.4 GHz carrier |
| | | | -103 | | dBc/Hz | 100 kHz offset from 16 GHz carrier |
| | | | -127 | | dBc/Hz | 1 MHz offset from 16 GHz carrier |
| | | | -145 | | dBc/Hz | 10 MHz offset from 16 GHz carrier |

| Parameter | Symbol | Min | Typ | Max | Unit | Test Conditions/Comments |
|--|--------|-----|--|-----|--|---|
| RF32x Output Phase Noise Performance where VCC_VCO = 5 V | | | -100 -123 -140 -97 -121 -137 | | dBc/Hz dBc/Hz dBc/Hz dBc/Hz dBc/Hz dBc/Hz | VCC_VCO = 5 V 100 kHz offset from 24 GHz carrier 1 MHz offset from 24 GHz carrier 10 MHz offset from 24 GHz carrier 100 kHz offset from 32 GHz carrier 1 MHz offset from 32 GHz carrier 10 MHz offset from 32 GHz carrier |
| Fundamental VCO Phase Noise Performance where VCC_VCO = 3.3 V | | | -116 -137 -156 -111 -133 -153 -109 -132 -153 | | dBc/Hz dBc/Hz dBc/Hz dBc/Hz dBc/Hz dBc/Hz dBc/Hz dBc/Hz dBc/Hz | VCO noise in open-loop conditions, VCC_VCO = 3.3 V 100 kHz offset from 4.0 GHz carrier 1 MHz offset from 4.0 GHz carrier 10 MHz offset from 4.0 GHz carrier 100 kHz offset from 5.7 GHz carrier 1 MHz offset from 5.7 GHz carrier 10 MHz offset from 5.7 GHz carrier 100 kHz offset from 8.0 GHz carrier 1 MHz offset from 8.0 GHz carrier 10 MHz offset from 8.0 GHz carrier |
| Normalized Inband Phase Noise Floor Fractional Channel ⁴ Integer Channel ⁵ Normalized 1/f Noise ⁶ Integrated RMS Jitter | PN1_f | | -233 -234 -127 38 | | dBc/Hz dBc/Hz dBc/Hz fs | 10 kHz offset; normalized to 1 GHz Wenzel oven controlled crystal oscillators (OCXO) as the reference frequency input (REF _{IN}), integer-N mode, phase frequency detector (PFD) = 245.76 MHz, 300 kHz loop filter bandwidth, 1 kHz to 100 MHz |
| Integer Boundary Spurs (Filtered) Inband Integer Boundary Spur (Unfiltered) Spurious Signals Due to PFD Frequency | | | -90 -55 -90 | | dBc dBc dBc | 960 kHz offset from integer channel Measured at 5 kHz offset from integer channel |
| FREQUENCY LOCK TIME ⁷ Lock Time with Automatic Calibration Lock Time with Automatic Calibration Bypassed | | | 3 30 | | ms μs | |

¹ T_A = 25°C, AV_{DD} = 3.3 V, VCC_VCO = 5.0 V, prescaler = 4/5, reference frequency (f_{REFP}) = 50 MHz, PFD frequency (f_{PFD}) = 50 MHz, and RF frequency (f_{RF}) = 5001 MHz. RF8x enabled. All RF outputs are disabled.

² Guaranteed by design and characterization.

³ RF output power using the EV-ADF4371SD2Z evaluation board differential outputs combined using a Marki BAL-0036 balun, and measured by a spectrum analyzer with the evaluation board and cable losses de-embedded. Highest power output selected for RF8P, RF8N, RFAUX8P, and RFAUX8N.

⁴ Use this value to calculate the phase noise for any application. To calculate inband phase noise performance as seen at the VCO output, use the following formula: -233 + 10log(f_{PFD}) + 20logN. The value given is the lowest noise mode for the fractional channel.

⁵ Use this value to calculate the phase noise for any application. To calculate inband phase noise performance as seen at the VCO output, use the following formula: -234 + 10log(f_{PFD}) + 20logN. The value given is the lowest noise mode for the integer channel.

⁶ The PLL phase noise is composed of 1/f (flicker) noise plus the normalized PLL noise floor. The formula for calculating the 1/f noise contribution at a radio frequency; (f_{RF}) and at a frequency offset (f) is given by PN1_f + 10log(10 kHz/f) + 20log(f_{RF}/1 GHz). Both the normalized phase noise floor and flicker noise are modeled in the ADIsimPLL design tool.

⁷ Lock time is measured for 100 MHz jump with standard evaluation board configuration.

TIMING SPECIFICATIONS

Table 2.

| Parameter | Symbol | Test Conditions/Comments | Min | Typ | Max | Unit |
|---|--------------|--------------------------------------|-----|-----|-----|------|
| Serial Port Interface (SPI) Timing | | See Figure 2, Figure 3, and Figure 4 | | | | |
| SCLK Frequency | f_{SCLK} | | | | 50 | MHz |
| SCLK Period | t_{SCLK} | | 20 | | | ns |
| SCLK Pulse Width High | t_{HIGH} | | 10 | | | ns |
| SCLK Pulse Width Low | t_{LOW} | | 10 | | | ns |
| SDIO Setup Time | t_{DS} | | 2 | | | ns |
| SDIO Hold Time | t_{DH} | | 2 | | | ns |
| SCLK Falling Edge to SDIO Valid Propagation Delay | t_{ACCESS} | | 10 | | | ns |
| \overline{CS} Rising Edge to SDIO High-Z | t_z | | 10 | | | ns |
| \overline{CS} Fall to SCLK Rise Setup Time | t_s | | 2 | | | ns |
| SCLK Fall to \overline{CS} Rise Hold Time | t_h | | 2 | | | ns |

Timing Diagrams



Figure 2. SPI Timing, MSB First (Upper) and LSB First (Lower)

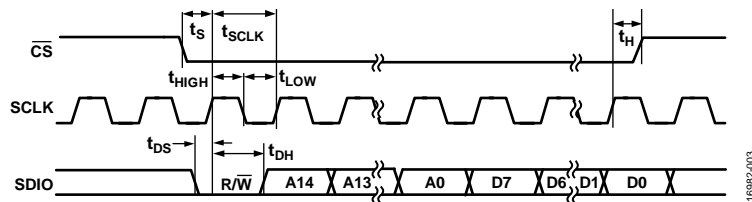

Figure 3. SPI Write Operation Timing

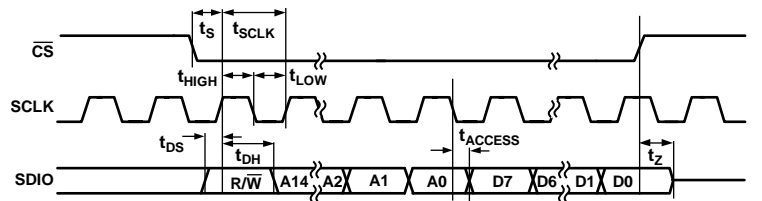

Figure 4. SPI Read Operation Timing

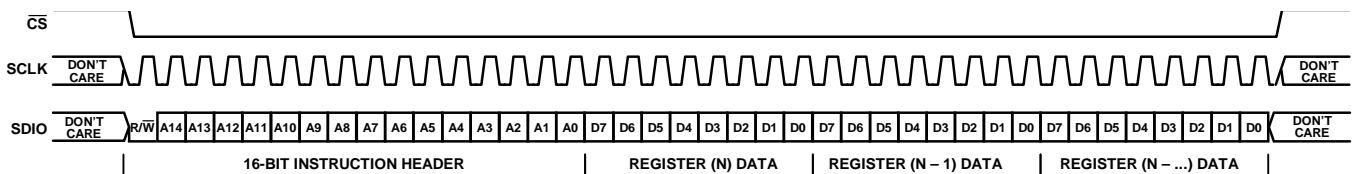

Figure 5. 3-Wire, MSB First, Descending Data, Streaming

ABSOLUTE MAXIMUM RATINGS

T_A = 25°C, unless otherwise noted.

Table 3.

| Parameter | Rating |
|--|------------------------------------|
| AV _{DD} Rails to GND ¹ | −0.3 V to +3.6 V |
| AV _{DD} Rails to Each Other | −0.3 V to +0.3 V |
| VCC_VCO to GND ¹ | −0.3 V to +5.5 V |
| VCC_VCO to AV _{DD} | −0.3 V to AV _{DD} + 2.8 V |
| CPOUT to GND ¹ | −0.3 V to AV _{DD} + 0.3 V |
| VTUNE to GND | −0.3 V to AV _{DD} + 0.3 V |
| Digital Input and Output Voltage to GND ¹ | −0.3 V to AV _{DD} + 0.3 V |
| Analog Input and Output Voltage to GND ¹ | −0.3 V to AV _{DD} + 0.3 V |
| REFP and REFN to GND ¹ | −0.3 V to AV _{DD} + 0.3 V |
| REFP to REFN | ±2.1 V |
| Temperature | |
| Operating Range | −40°C to +105°C |
| Storage Range | −65°C to +125°C |
| Maximum Junction | 125 °C |
| Reflow Soldering | |
| Peak | 260°C |
| Time at Peak | 30 sec |
| Electrostatic Discharge (ESD) | |
| Charged Device Model | 1.0 kV |
| Human Body Model | 4.0 kV |
| Transistor Count | |
| Complementary Metal-Oxide Semiconductor (CMOS) | 131439 |
| Bipolar | 4063 |

¹ GND = 0 V.

Stresses at or above those listed under Absolute Maximum Ratings may cause permanent damage to the product. This is a stress rating only; functional operation of the product at these or any other conditions above those indicated in the operational section of this specification is not implied. Operation beyond the maximum operating conditions for extended periods may affect product reliability.

THERMAL RESISTANCE

Thermal performance is directly linked to printed circuit board (PCB) design and operating environment. Close attention to PCB thermal design is required.

θ_{JA} is the natural convection, junction to ambient thermal resistance measured in a one cubic foot sealed enclosure. θ_{JC} is the junction to case thermal resistance.

Table 4. Thermal Resistance

| Package Type | θ _{JA} | θ _{JC} | Unit |
|----------------------|-----------------|-----------------|------|
| CC-48-4 ¹ | 25 | 14.4 | °C/W |

¹ Test Condition 1: Thermal impedance simulated values are based on JESD51 standard.

ESD CAUTION



ESD (electrostatic discharge) sensitive device. Charged devices and circuit boards can discharge without detection. Although this product features patented or proprietary protection circuitry, damage may occur on devices subjected to high energy ESD. Therefore, proper ESD precautions should be taken to avoid performance degradation or loss of functionality.

PIN CONFIGURATION AND FUNCTION DESCRIPTIONS

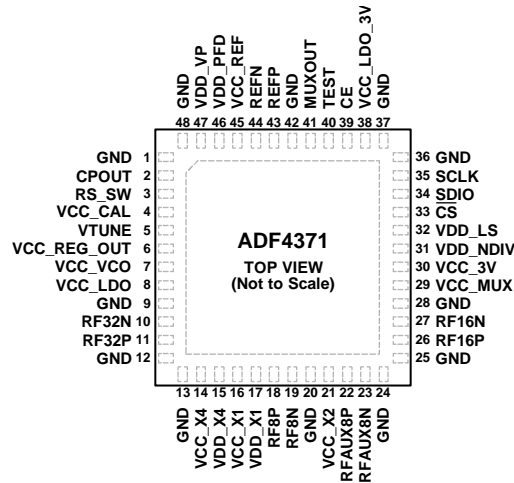

NOTES
 1. THE LAND GRID ARRAY (LGA) HAS AN EXPOSED PAD THAT MUST BE SOLDERED TO A METAL PLATE ON THE PCB FOR MECHANICAL REASONS AND TO GND.

Figure 6. Pin Configuration

Table 5. Pin Function Descriptions

| Pin No. | Mnemonic | Description |
|--|-------------|---|
| 1, 9, 12, 13, 20, 24, 25, 28, 36, 37, 42, 48 | GND | Ground Return. |
| 2 | CPOUT | Charge Pump Output. When enabled, this output provides $\pm I_{CP}$ to the external loop filter. The output of the loop filter is connected to VTUNE to drive the internal VCO. |
| 3 | RS_SW | Loop Filter Switch. Used for switching loop filter resistors in fastlock applications. |
| 4 | VCC_CAL | Power Supply for Internal Calibration Monitor Circuit. The voltage on this pin ranges from 3.15 V to 3.45 V. VCC_CAL must have the same value as AV_{DD} , nominally 3.3 V. |
| 5 | VTUNE | Control Input to the VCO. This voltage determines the output frequency and is derived from filtering the CPOUT output voltage. |
| 6 | VCC_REG_OUT | VCO Supply Regulator Out. The output supply voltage of the VCO regulator is available at this pin, and must be decoupled to GND with a 10 μ F capacitor and shorted to the VCC_VCO pin. Leave this pin open if an external LDO regulator is connected to VCC_VCO. |
| 7 | VCC_VCO | Power Supply for the VCO. The voltage on this pin ranges from 4.75 V to 5.25 V. Place decoupling capacitors to the analog ground plane as close to this pin as possible. For optimal performance, this supply must be clean and have low noise. |
| 8 | VCC_LDO | Supply Pin to the VCO Regulator. If the internal regulator is used, connect the voltage supply here to VCC_LDO. The voltage on this pin ranges from 4.75 V to 5.25 V. If the external regulator is used, short this pin to VCC_VCO. |
| 10 | RF32N | Quadrupler Output. AC or dc couple this pin to the next stage. This pin can be powered off when not in use. If unused, this pin can be left open. |
| 11 | RF32P | Complementary Quadrupler Output. AC or dc couple this pin to the next stage. This pin can be powered off when not in use. If unused, this pin can be left open. |
| 14 | VCC_X4 | Power Supply for the Quadrupler RF Output. The voltage on this pin must have the same value as AV_{DD} . |
| 15 | VDD_X4 | Digital Supply for the Quadrupler Circuit. The voltage on this pin must have the same value as AV_{DD} . |
| 16 | VCC_X1 | Power Supply for the Main RF Output. The voltage on this pin must have the same value as AV_{DD} . |
| 17 | VDD_X1 | Digital Supply for the Main RF Circuit. The voltage on this pin must have the same value as AV_{DD} . |
| 18 | RF8P | Main RF Output. AC couple to the next stage. The output level is programmable. The VCO fundamental output or a divided down version is available. |
| 19 | RF8N | Complementary Main RF Output. AC couple this pin to the next stage. The output level is programmable. The VCO fundamental output or a divided down version is available. |
| 21 | VCC_X2 | Power Supply for the Doubled RF Output. The voltage on this pin must have the same value as AV_{DD} . |
| 22 | RFAUX8P | Auxiliary RF Output. AC couple to the next stage. This pin can be powered off when not in use. |

| Pin No. | Mnemonic | Description |
|---------|-----------------|---|
| 23 | RFAUX8N | Complementary Auxiliary RF Output. AC couple this pin to the next stage. This pin can be powered off when not in use. |
| 26 | RF16P | Doubled VCO Output. AC or dc couple this pin to the next stage. This pin can be powered off when not in use. If unused, this pin can be left open. |
| 27 | RF16N | Complementary Doubled VCO Output. AC or dc couple this pin to the next stage. This pin can be powered off when not in use. If unused, this pin can be left open. |
| 29 | VCC_MUX | Power Supply for the VCO Mux. The voltage on this pin must have the same value as AV _{DD} . |
| 30 | VCC_3V | Analog Power Supply. The voltage on this pin must have the same value as AV _{DD} . |
| 31 | VDD_NDIV | N Divider Power Supply. The voltage on this pin must have the same value as AV _{DD} . |
| 32 | VDD_LS | Level Shifter Power Supply. The voltage on this pin must have the same value as AV _{DD} . |
| 33 | \overline{CS} | Chip Select, CMOS Input. When \overline{CS} goes high, the data stored in the shift register is loaded into the register that is selected by the address bits. |
| 34 | SDIO | Serial Data Input Output. This input is a high impedance CMOS input. |
| 35 | SCLK | Serial Clock Input. Data is clocked into the 24-bit shift register on the clock rising (or falling) edge. This input is a high impedance CMOS input. |
| 38 | VCC_LDO_3V | Regulator Input for 1.8 V Digital Logic. The voltage on this pin must have the same value as AV _{DD} . |
| 39 | CE | Chip Enable. Connect to 3.3 V or AV _{DD} . |
| 40 | TEST | Factory Test Pin. Connect this pin to ground. |
| 41 | MUXOUT | Mux Output. The mux output allows the digital lock detect, the analog lock detect, scaled RF, or the scaled reference frequency to be externally accessible. This pin can be programmed to output the register settings in 4-wire SPI mode. |
| 43 | REFP | Reference Input. If driving the device with a single-ended reference, ac couple the signal to the REFP pin. |
| 44 | REFN | Complementary Reference Input. If unused, ac couple this pin to GND. REFP and REFN must be ac-coupled if driven differentially. If driven single-ended, the reference signal must be connected to REFP, and the REFN must be ac-coupled to GND. In differential configuration, the differential impedance is 100 Ω . |
| 45 | VCC_REF | Power Supply to the Reference Buffer. The voltage on this pin must have the same value as AV _{DD} . |
| 46 | VDD_PFD | Power Supply to the PFD. The voltage on this pin must have the same value as AV _{DD} . |
| 47 | VDD_VP | Charge Pump Power Supply. The voltage on this pin must have the same value as AV _{DD} . A 1 μ F decoupling capacitor to GND must be included to minimize spurious signals. |
| | EP | Exposed Pad. The land grid array (LGA) has an exposed pad that must be soldered to a metal plate on the PCB for mechanical reasons and to GND. |

TYPICAL PERFORMANCE CHARACTERISTICS

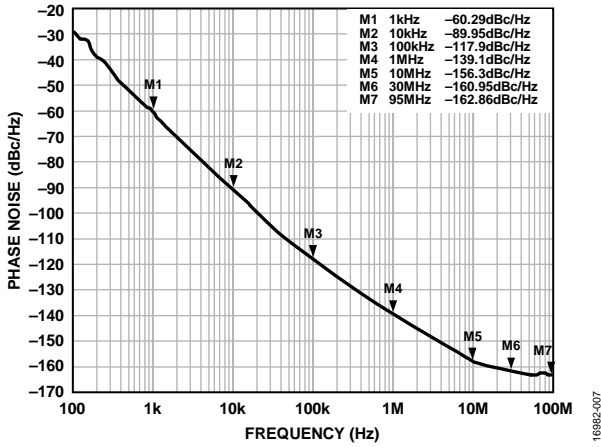

Figure 7. Open-Loop VCO Phase Noise, 4.0 GHz, VCC_VCO = 5 V

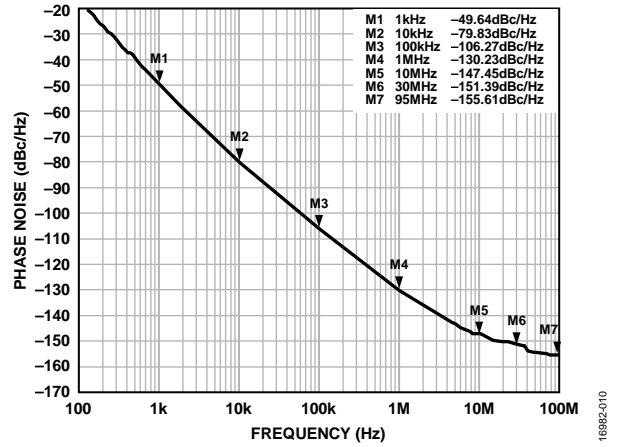

Figure 10. Open-Loop VCO Phase Noise at RF16x Output, 11.4 GHz, VCC_VCO = 5 V

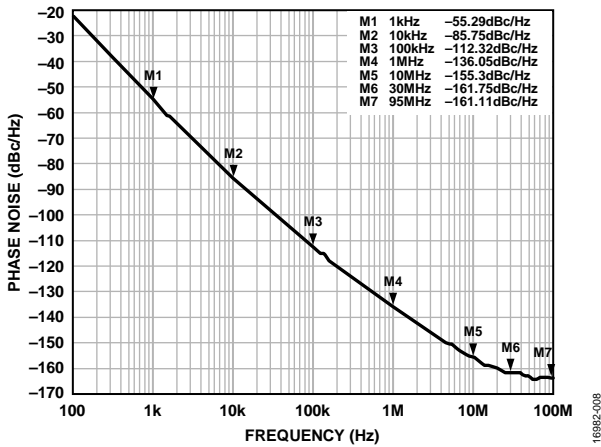

Figure 8. Open-Loop VCO Phase Noise, 5.7 GHz, VCC_VCO = 5 V

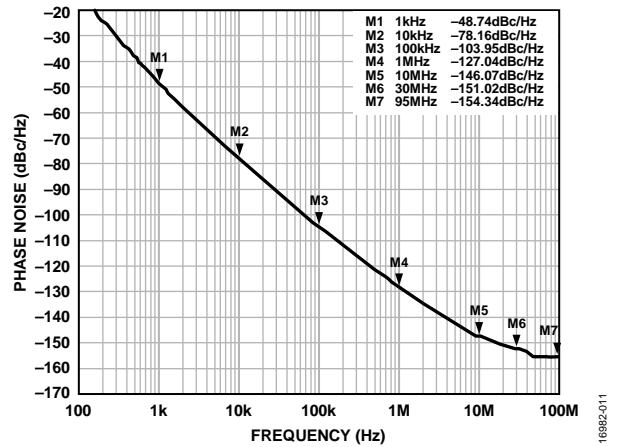

Figure 11. Open-Loop VCO Phase Noise at RF16x Output, 16.0 GHz, VCC_VCO = 5 V

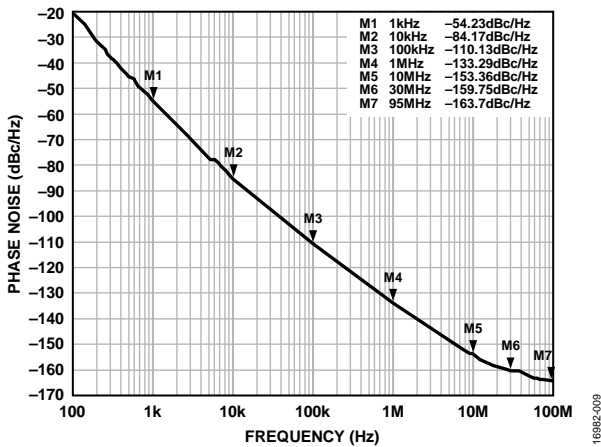

Figure 9. Open-Loop VCO Phase Noise, 8.0 GHz, VCC_VCO = 5 V

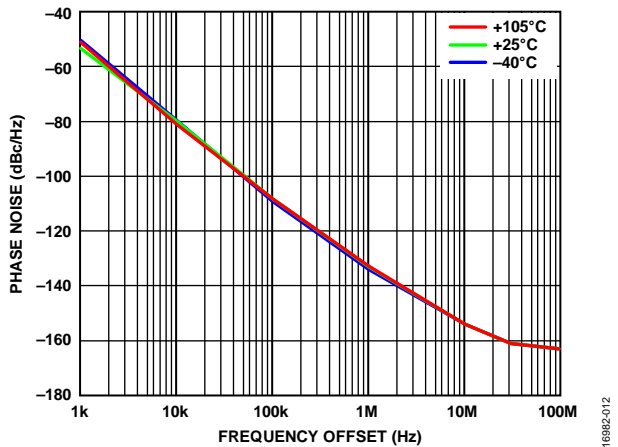

Figure 12. Open-Loop VCO Phase Noise over Temperature, 8.0 GHz, VCC_VCO = 5 V

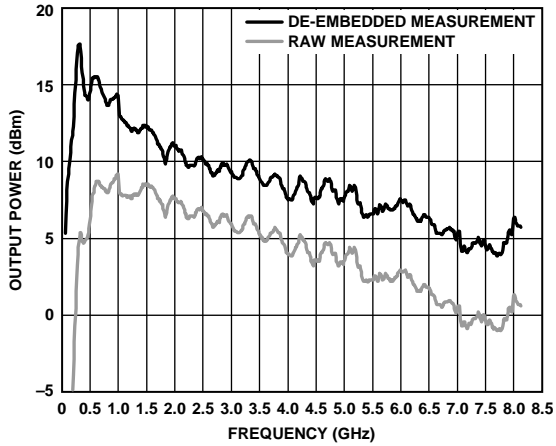

Figure 13. RF8P and RF8N Output Power, De-Embedded Board and Cable Measurement, Combined Using Balun (7.4 nH Inductors, 10 pF AC Coupling Capacitors Limit Power at Low Frequencies)

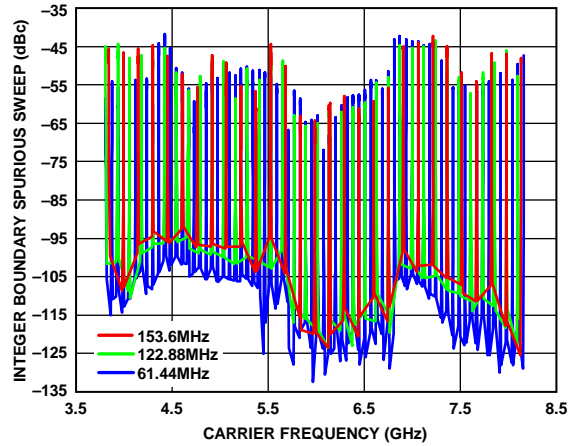

Figure 16. Integer Boundary Spurious Sweep vs. Corner Frequency, PFD Frequencies = 61.44 MHz, 122.88 MHz, and 153.6 MHz, Loop Filter Bandwidth = 100 kHz

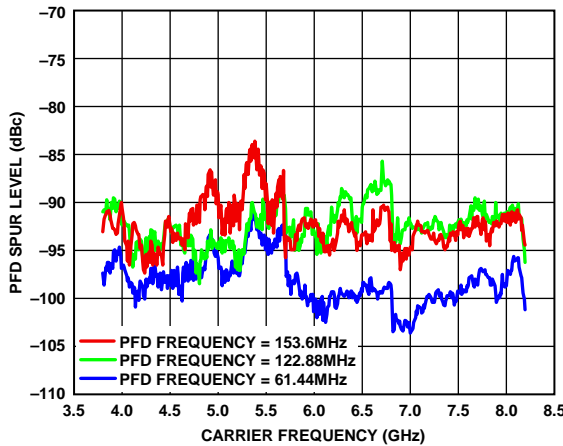

Figure 14. PFD Spurious Sweep, PFD Frequency = 61.44 MHz, Loop Filter Bandwidth = 100 kHz

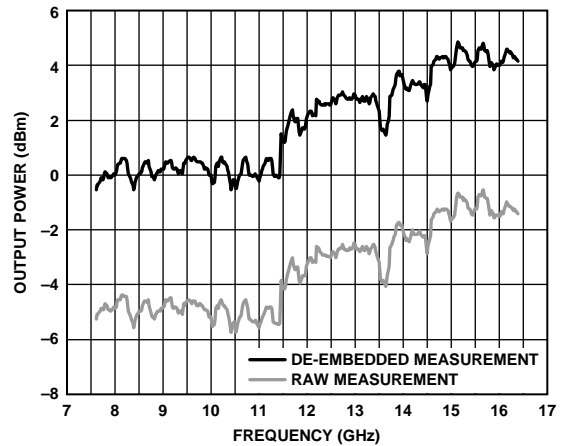

Figure 17. RF16P and RF16N Output Power, De-Embedded Board and Cable Measurement, Combined Using Balun

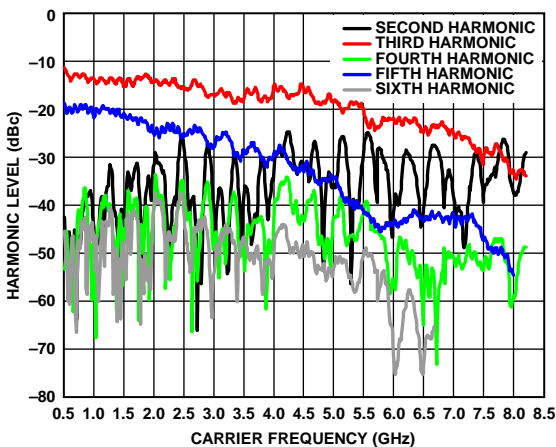

Figure 15. RF8P and RF8N Output Harmonics, De-Embedded Board and Cable Measurement, Combined Using Balun

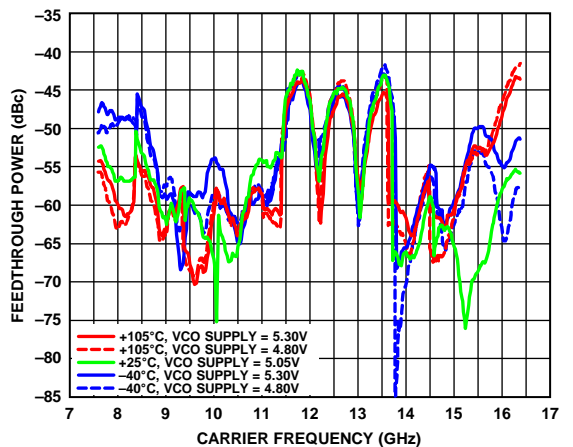

Figure 18. RF16P and RF16N VCO Feedthrough, De-Embedded Board and Cable Measurement, Combined Using Balun

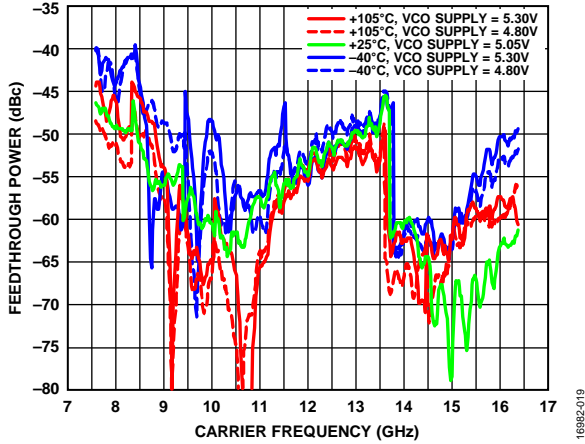

Figure 19. RF16P and RF16N VCO × 3 Feedthrough, De-Embedded Board and Cable Measurement, Combined Using Balun

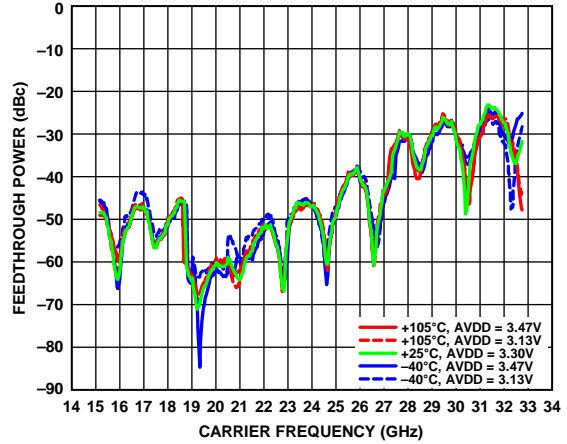

Figure 22. RF32P and RF32N VCO Feedthrough, De-Embedded Board and Cable Measurement, Combined Using Balun

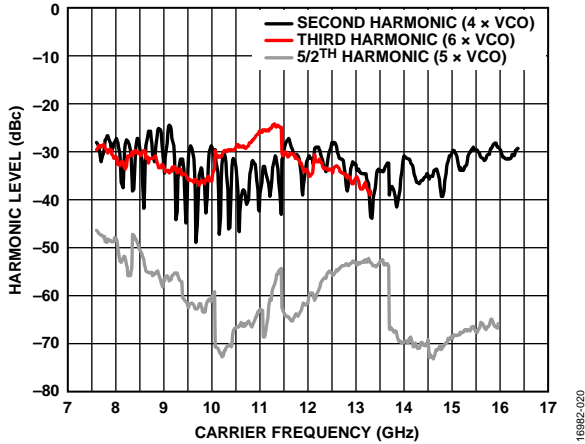

Figure 20. RF16P and RF16N Output Harmonics, De-Embedded Board and Cable Measurement, Combined Using Balun

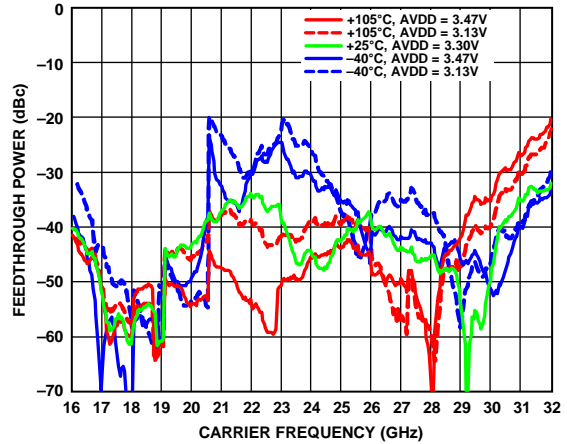

Figure 23. RF32P and RF32N VCO × 2 Feedthrough, De-Embedded Board and Cable Measurement, Combined Using Balun

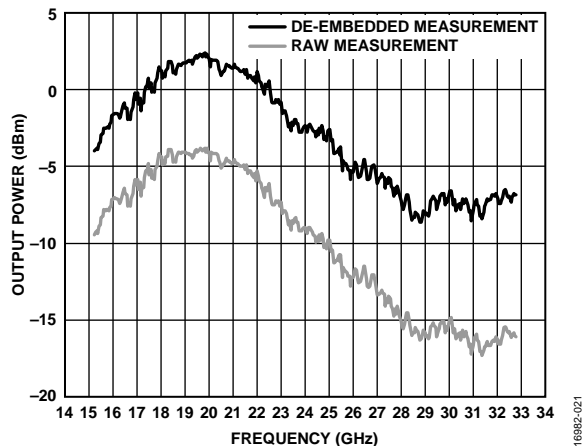

Figure 21. RF 32P and RF32N Output Power, De-Embedded Board and Cable Measurement, Combined Using Balun

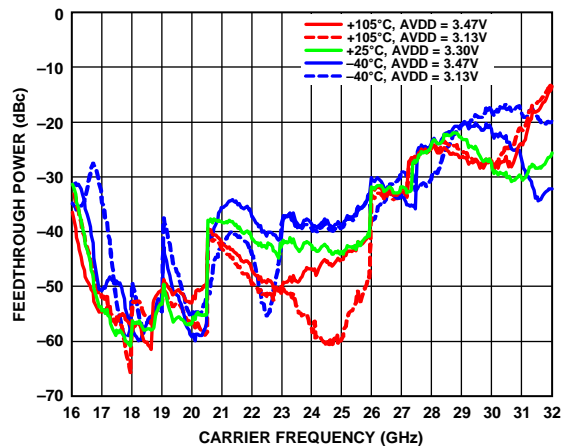

Figure 24. RF32P and RF32N VCO × 3 Feedthrough, De-Embedded Board and Cable Measurement, Combined Using Balun



Figure 25. RF32P and RF32N VCO \times 5 Feedthrough, De-Embedded Board and Cable Measurement, Combined Using Balun

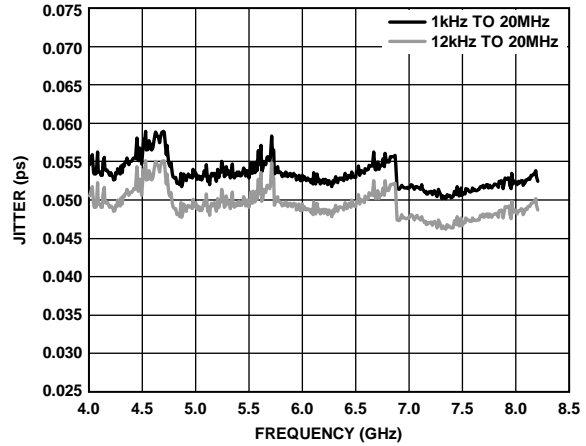

Figure 27. RMS Jitter, Fractional-N, $f_{PFD} = 153.6$ MHz, $V_{CC_VCO} = 5$ V

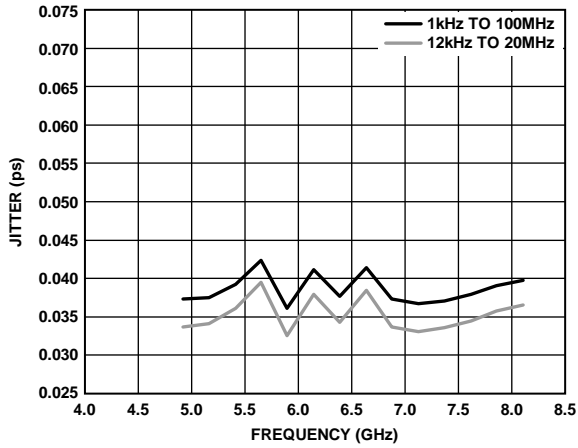

Figure 26. RMS Jitter, Integer N, PFD Frequency (f_{PFD}) = 245.76 MHz, Loop Filter Bandwidth = 220 kHz, $V_{CC_VCO} = 5$ V

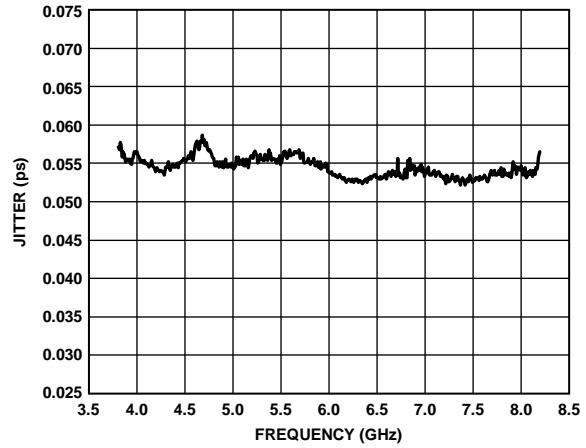
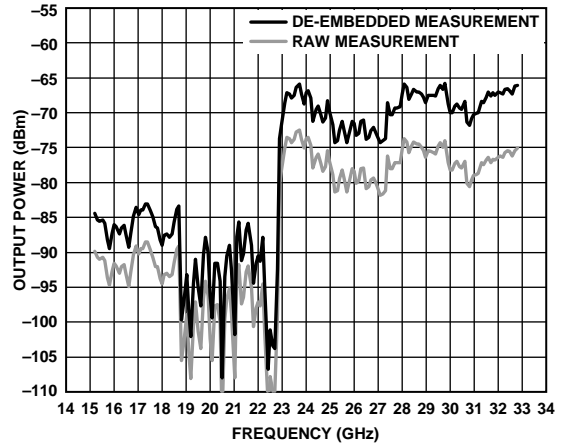

Figure 28. RMS Jitter Integrated from 1 kHz to 100 MHz, Fractional-N, $f_{PFD} = 153.6$ MHz, $V_{CC_VCO} = 3.3$ V



16892-050

Figure 29. RF8P and RF8N Output Power When Disabled, De-Embedded Board and Cable Measurement, Combined Using Balun



16892-052

Figure 31. RF32P and RF32N Output Power When Disabled, De-Embedded Board and Cable Measurement, Combined Using Balun

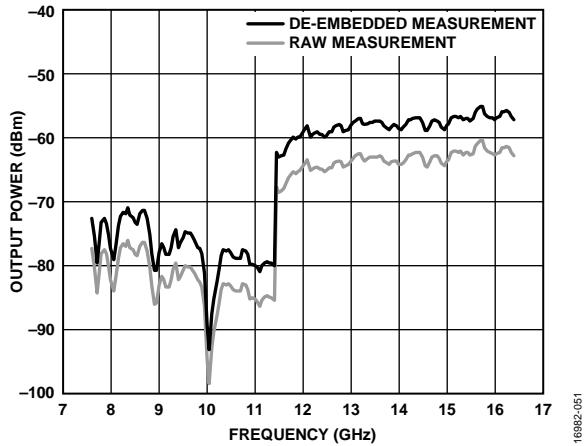

16892-051

Figure 30. RF16P and RF16N Output Power When Disabled, De-Embedded Board and Cable Measurement, Combined Using Balun

THEORY OF OPERATION

RF SYNTHESIZER, A WORKED EXAMPLE

Use the following equations to program the ADF4371 synthesizer:

$$f_{RFOUT} = INT + \frac{FRAC1 + \frac{FRAC2}{MOD2}}{MOD1} \times \frac{f_{PFD}}{RF\ Divider} \quad (1)$$

where:

f_{RFOUT} is the RF output frequency.

INT is the integer division factor.

$FRAC1$ is the fractionality.

$FRAC2$ is the auxiliary fractionality.

$MOD1$ is the fixed 25-bit modulus.

$MOD2$ is the auxiliary modulus.

$RF\ Divider$ is the output divider that divides down the VCO frequency.

$$f_{PFD} = REF_{IN} \times ((1 + D)/(R \times (1 + T))) \quad (2)$$

where:

REF_{IN} is the reference frequency input.

D is the REF_{IN} doubler bit.

R is the reference division factor.

T is the reference divide by 2 bit (0 or 1).

For example, in a universal mobile telecommunication system (UMTS) where a 2112.8 MHz f_{RFOUT} is required, a 122.88 MHz REF_{IN} is available. The ADF4371 VCO operates in the frequency range of 4 GHz to 8 GHz. Therefore, the RF divider of 2 must be used (VCO frequency = 4225.6 MHz, $RF_{OUT} = VCO\ frequency/RF\ divider = 4225.6\ MHz/2 = 2112.8\ MHz$).

The feedback path is also important. In this example, the VCO output is fed back before the output divider (see Figure 32).

In this example, the 122.88 MHz reference signal is divided by 2 to generate a f_{PFD} of 61.44 MHz. The desired channel spacing is 200 kHz.



Figure 32. Loop Closed Before Output Divider

The values used in this worked example are as follows:

$$N = f_{VCO_OUT}/f_{PFD} = 4225.6\ MHz/61.44\ MHz = 68.776041666666667 \quad (3)$$

where:

N is the desired value of the feedback counter, N .

f_{VCO_OUT} is the output frequency of the VCO voltage controlled oscillator without using the output divider.

f_{PFD} is the frequency of the phase frequency detector.

$$INT = INT(VCO\ frequency/f_{PFD}) = 68 \quad (4)$$

$$FRAC = 0.776041666666667 \quad (5)$$

where:

$FRAC$ is the fractional part of the N .

$$MOD1 = 33,554,432 \quad (6)$$

$$FRAC1 = INT(MOD1 \times FRAC) = 26,039,637 \quad (7)$$

$$\text{Remainder} = 0.3333333333\ \text{or}\ 1/3 \quad (8)$$

$$MOD2 = f_{PFD}/GCD(f_{PFD}, f_{CHSP}) = 61.44\ MHz/GCD(61.44\ MHz, 200\ kHz) = 1536 \quad (9)$$

where:

GCD is the greatest common divider operant.

$$FRAC2 = \text{Remainder} \times 1536 = 512 \quad (10)$$

From Equation 2,

$$f_{PFD} = (122.88\ MHz \times (1 + 0)/2) = 61.44\ MHz \quad (11)$$

$$2112.8\ MHz = 61.44\ MHz \times ((INT + (FRAC1 + FRAC2/MOD2)/2^{25}))/2 \quad (12)$$

where:

$INT = 68$.

$FRAC1 = 26,039,637$.

$MOD2 = 1536$.

$FRAC2 = 512$.

$RF\ Divider = 2$.

REFERENCE INPUT SENSITIVITY

The slew rate of the input reference signal significantly affects the performance. The device is functional with signals of very low amplitude down to 0.4 V p-p and with a slew rate of 21 V/ μ s. However, the optimal performance is achieved with slew rates as high as 1000 V/ μ s. Achieving this slew rate with sinusoidal waves requires high amplitudes and may not be possible at low frequencies. The jitter and phase noise performance of the ADF4371 is shown in Figure 33 and Figure 34 for PFD frequencies of 250 MHz and 100 MHz, respectively. A high performance square wave signal with a high slew rate is recommended as the reference input signal to achieve the best performance.

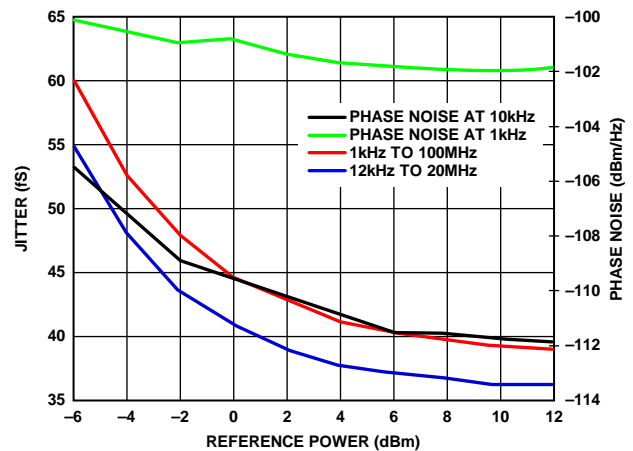

Figure 33. Jitter and Phase Noise, $f_{PFD} = 250\ MHz$

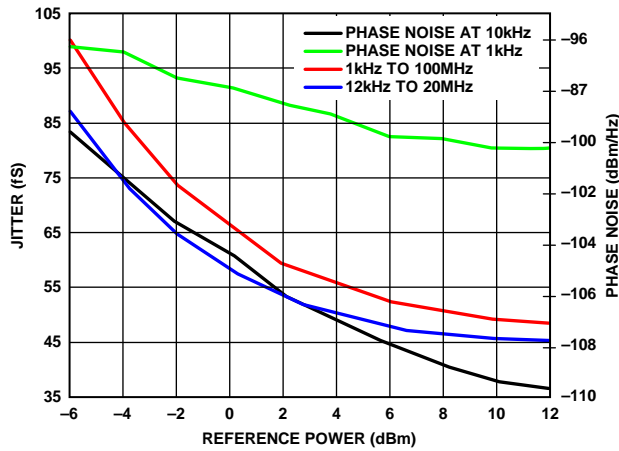

Figure 34. Jitter and Phase Noise, $f_{\text{PFD}} = 100 \text{ MHz}$

REFERENCE DOUBLER AND REFERENCE DIVIDER

The on-chip reference doubler allows the input reference signal to be doubled. The doubler is useful for increasing the PFD comparison frequency. To improve the noise performance of the system, increase the PFD frequency. Doubling the PFD frequency typically improves noise performance by 3 dB.

The reference divide by 2 divides the reference signal by 2, resulting in a 50% duty cycle PFD frequency.

SPURIOUS OPTIMIZATION AND FAST LOCK

Narrow loop bandwidths can filter unwanted spurious signals. However, these bandwidths typically have a long lock time. A wider loop bandwidth achieves faster lock times, but can lead to increased spurious signals inside the loop bandwidth.

OPTIMIZING JITTER

For lowest jitter applications, use the highest possible PFD frequency to minimize the contribution of inband noise from the PLL. Set the PLL filter bandwidth such that the inband noise of the PLL intersects with the open-loop noise of the VCO, minimizing the contribution of both to the overall noise.

Use the [ADIsimPLL](#) design tool for this task.

Additional Optimization on Loop Filter

The PLL filter is designed to find an optimum bandwidth for the reference, PFD, and VCO noise, depending on the system requirements. In addition to this design, when the Σ - Δ modulator (SDM) is enabled, further optimization may be necessary to filter SDM noise.

Reducing Sigma Delta Modulator Noise

In fractional mode, SDM noise becomes apparent and starts to contribute to overall phase noise. This noise can be reduced to insignificant levels by using a series resistor between the CPOUT pin and the loop filter. Place this resistor close to the CPOUT pin. A reasonable resistor value does not affect the loop bandwidth and phase margin of the designed loop filter. In most cases, 91 Ω gives the best results. This resistor is not required in integer mode (SDM not enabled) or when a narrow-band loop filter is used (SDM noise attenuated).

SPUR MECHANISMS

This section describes the two different spur mechanisms that arise with a fractional-N synthesizer and how to minimize them in the ADF4371.

Integer Boundary Spurs

One mechanism for fractional spur creation is the interactions between the RF VCO frequency and the reference frequency. When these frequencies are not integer related (which is the purpose of a fractional-N synthesizer), spur sidebands appear on the VCO output spectrum at an offset frequency that corresponds to the beat note or the difference in frequency between an integer multiple of the reference and the VCO frequency. These spurs are attenuated by the loop filter and are more noticeable on channels close to integer multiples of the reference where the difference frequency can be inside the loop bandwidth.

Reference Spurs

Reference spurs are generally not a problem in fractional-N synthesizers because the reference offset is far outside the loop bandwidth. However, any reference feedthrough mechanism that bypasses the loop can cause a problem. Feedthrough of low levels of on-chip reference switching noise through the prescaler back to the VCO can result in reference spur levels as high as -100 dBc .

LOCK TIME

The PLL lock time divides into a number of settings. The total lock time for changing frequencies is the sum of the four separate times: synthesizer lock, VCO band selection, automatic level calibration (ALC), and PLL settling time.

Synthesizer Lock

The synthesizer lock timeout ensures that the VCO calibration DAC, which forces the VCO tune voltage (V_{TUNE}), has settled to a steady value for the band select circuitry. SYNTH_LOCK_TIMEOUT and TIMEOUT select the length of time the DAC is allowed to settle to the final voltage before the VCO calibration process continues to the next phase (VCO band selection).

The PFD frequency is the clock for this logic, and the duration is set using the following equation:

$$\frac{\text{SYNTH_LOCK_TIMEOUT} \times 1024 + \text{TIMEOUT}}{f_{\text{PFD}}} \quad (13)$$

where:

SYNTH_LOCK_TIMEOUT is programmed in REG0033.

TIMEOUT is programmed in REG0031 and REG0032.

The calculated time must be greater than or equal to 20 μs .

For the SYNTH_LOCK_TIMEOUT bit, the minimum value is 2 and the maximum value is 31. For Timeout, the minimum value is 2 and the maximum value is 1023.

VCO Band Selection

VCO_BAND_DIV (programmed in REG0030) and PFD frequency are used to generate the VCO band selection clock as follows:

$$f_{BSC} = \frac{f_{PFD}}{VCO_BAND_DIV} \quad (14)$$

The calculated time must be less than 2.4 MHz.

16 clock cycles are required for one VCO core and band calibration step and the total band selection process takes 11 steps, resulting in the following equation:

$$11 \times \frac{16 \times VCO_BAND_DIV}{f_{PFD}} \quad (15)$$

The minimum value for VCO_BAND_DIV is 1 and the maximum value is 255.

Automatic Level Calibration (ALC)

Use the ALC function to choose the correct bias current in the ADF4371 VCO core. The duration required for VCO bias voltage to settle for each step. This duration is set by the following equation:

$$\frac{VCO_ALC_TIMEOUT \times 1024 + TIMEOUT}{f_{PFD}} \quad (16)$$

where

VCO_ALC_TIMEOUT and Timeout are programmed in REG0034, REG0032, and REG0031.

The calculated time must be greater than or equal to 50 μ s.

The total ALC takes 63 steps:

$$63 \times \frac{VCO_ALC_TIMEOUT \times 1024 + TIMEOUT}{f_{PFD}} \quad (17)$$

The minimum value for VCO_ALC_TIMEOUT is 2 and the maximum value is 31.

PLL Settling Time

The time taken for the loop to settle is inversely proportional to the low-pass filter bandwidth. The settling time is accurately modeled in the [ADIsimPLL](#) design tool.

Lock Time, a Worked Example

Assume that $f_{PFD} = 61.44$ MHz,

$$VCO_BAND_DIV = \text{Ceiling}(f_{PFD}/2,400,000) = 26 \quad (18)$$

where Ceiling() rounds up to the nearest integer.

$$SYNTH_LOCK_TIMEOUT \times 1024 + TIMEOUT > 1228.8 \quad (19)$$

$$VCO_ALC_TIMEOUT \times 1024 + TIMEOUT > 3072 \quad (20)$$

There are several suitable values that meet these criteria. By considering the minimum specifications, the following values are the most suitable:

- SYNTH_LOCK_TIMEOUT = 2 (minimum value)
- VCO_ALC_TIMEOUT = 3
- TIMEOUT = 2

Much faster lock times than those detailed in this data sheet are possible by bypassing the calibration processes. Contact Analog Devices, Inc., for more information.

CIRCUIT DESCRIPTION

REFERENCE INPUT

Figure 35 shows the reference input stage. The reference input can accept both single-ended and differential signals. Use the reference mode bit (Bit 6 in REG0022) to select the signal. To use a differential signal on the reference input, program this bit high. In this case, SW1 and SW2 are open, SW3 and SW4 are closed, and the current source that drives the differential pair of transistors switches on. The differential signal is buffered, and it is provided to an emitter coupled logic (ECL) to the CMOS converter.

When a single-ended signal is used as the reference, connect the reference signal to REFP and program Bit 6 in REG0022 to 0. In this case, SW1 and SW2 are closed, SW3 and SW4 are open, and the current source that drives the differential pair of transistors switches off.

For optimum integer boundary spur and phase noise performance, use the single-ended setting for all references up to 500 MHz (even if using a differential signal). Use the differential setting for reference frequencies greater than 500 MHz.

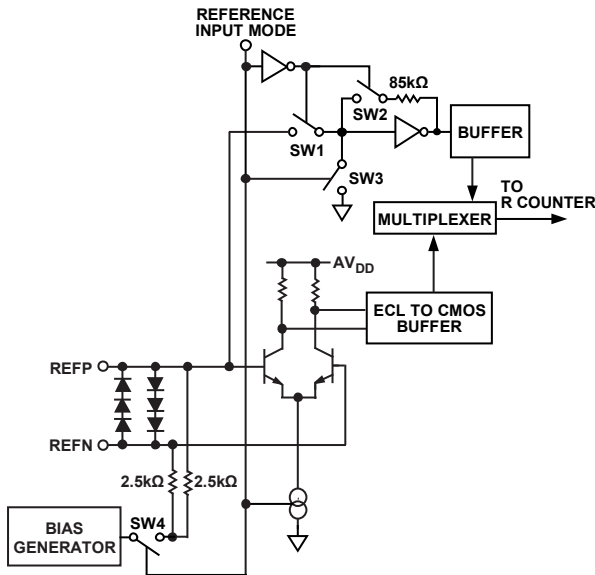

Figure 35. Reference Input Stage, Differential Mode

RF N DIVIDER

The RF N divider allows a division ratio in the PLL feedback path. Determine the division ratio by the INT, FRAC1, FRAC2, and MOD2 values that this divider comprises.

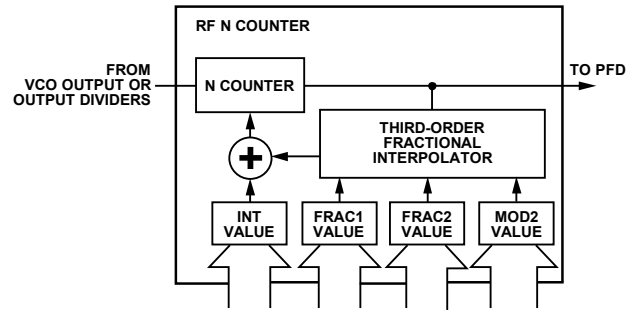

Figure 36. RF N Divider

INT, FRAC, MOD, and R Counter Relationship

The INT, FRAC1, FRAC2, MOD1, and MOD2 values, in conjunction with the R counter, make it possible to generate output frequencies that are spaced by fractions of f_{PFD} . For more information, see the RF Synthesizer, a Worked Example section.

Calculate f_{VCO_OUT} using the following equation:

$$f_{VCO_OUT} = f_{PFD} \times N \tag{21}$$

Calculate f_{PFD} using the following equation:

$$f_{PFD} = REF_{IN} \times \frac{1 + D}{R \times (1 + T)} \tag{22}$$

where:

REF_{IN} is the reference frequency input.

D is the REF_{IN} doubler bit.

R is the preset divide ratio of the binary 10-bit programmable reference counter (1 to 1023).

T is the REF_{IN} divide by 2 bit (0 or 1)

Calculate the desired value of the feedback counter N using the following equation:

$$N = INT + \frac{FRAC1 + \frac{FRAC2}{MOD2}}{MOD1} \tag{23}$$

where:

INT is the 16-bit integer value. In integer mode, $INT = 20$ to 32,767 for the 4/5 prescaler, and 64 to 65,535 for the 8/9 prescaler. In fractional mode, $INT = 23$ to 32,767 for the 4/5 prescaler, and 75 to 65,535 for the 8/9 prescaler.

$FRAC1$ is the numerator of the primary modulus (0 to 33,554,431).

$FRAC2$ is the numerator of the 14-bit auxiliary modulus (0 to 16,383).

$MOD2$ is the programmable, 14-bit auxiliary fractional modulus (2 to 16,383).

$MOD1$ is a 25-bit primary modulus with a fixed value of $2^{25} = 33,554,432$.

These calculations result in a very low frequency resolution with no residual frequency error. To apply Equation 23, perform the following steps:

1. Calculate N by dividing VCO_{OUT}/f_{PFD} . The integer value of this number forms INT .

2. Subtract INT from the full N value.
3. Multiply the remainder by 2^{25} . The integer value of this number forms FRAC1.
4. Calculate MOD2 based on the channel spacing (f_{CHSP}) using the following equation:

$$MOD2 = f_{PFD} / GCD(f_{PFD}, f_{CHSP}) \quad (24)$$

where:

f_{CHSP} is the desired channel spacing frequency.
 $GCD(f_{PFD}, f_{CHSP})$ is the greatest common divisor of the PFD frequency and the channel spacing frequency.

5. Calculate FRAC2 using the following equation:

$$FRAC2 = ((N - INT) \times 2^{25} - FRAC1) \times MOD2 \quad (25)$$

The FRAC2 and MOD2 fraction result in outputs with zero frequency error for channel spacing when

$$f_{PFD} / GCD(f_{PFD}, f_{CHSP}) = MOD2 < 16,383 \quad (26)$$

If zero frequency error is not required, the MOD1 and MOD2 denominators operate together to create a 39-bit resolution modulus.

INT N Mode

When FRAC1 and FRAC2 are equal to 0, the synthesizer operates in integer N mode. It is recommended that the SD_EN_FRAC0 bit in REG002B be set to 1 to disable the SDMs, which gives an improvement in the inband phase noise, and reduces any additional $\Sigma\Delta$ noise.

R Counter

The 5-bit R counter allows the input reference frequency (input to REFP and REFN) to be divided down to produce the reference clock to the PFD. Division ratios from 1 to 1023 are allowed.

PFD AND CHARGE PUMP

The PFD takes inputs from the R counter and N counter and produces an output proportional to the phase and frequency difference between them. Figure 37 is a simplified schematic of the phase frequency detector. The PFD includes a fixed delay element that sets the width of the antibacklash pulse. This pulse ensures that there is no dead zone in the PFD transfer function and provides a consistent reference spur level. Set the phase detector polarity to positive on this device because of the positive tuning of the VCO.

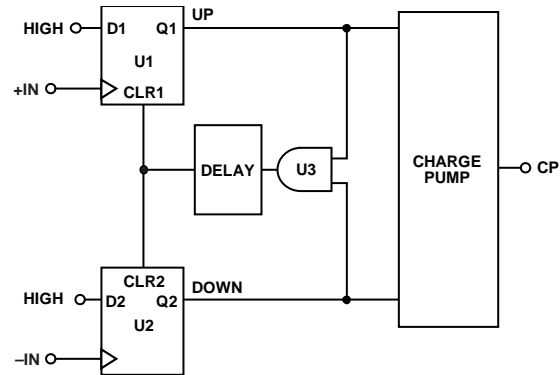

Figure 37. PFD Simplified Schematic

16982-031

MUXOUT AND LOCK DETECT

The output multiplexer on the ADF4371 allows the user to access various internal points on the chip. Figure 38 shows the MUXOUT section in block diagram form.

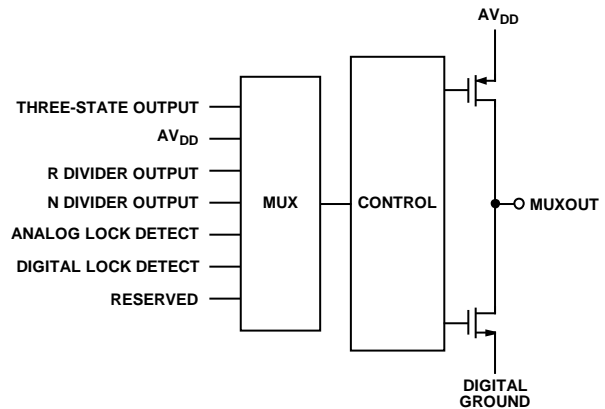

Figure 38. MUXOUT Schematic

16982-032

DOUBLE BUFFERS

The main fractional value (FRAC1), auxiliary modulus value (MOD2), auxiliary fractional value (FRAC2), reference doubler, reference divide by 2 (RDIV2), R counter value, and charge pump current setting are double buffered in the ADF4371. Two events must occur before the ADF4371 uses a new value for any of the double buffered settings. First, the new value must latch into the device by writing to the appropriate register, and second, a new write to REG0010 must be performed.

For example, to ensure that the modulus value loads correctly, every time that the modulus value updates, REG0010 must be written to.

VCO

The VCO core in the ADF4371 consists of four separate VCO cores, Core A, Core B, Core C, and Core D, each of which uses 256 overlapping bands, which allows the device to cover a wide frequency range without large VCO sensitivity (K_v) and without resultant poor phase noise and spurious performance.

The correct VCO and band are chosen automatically by the VCO and band select logic whenever REG0010 is updated and automatic calibration is enabled. The V_{TUNE} is disconnected from the output of the loop filter and is connected to an internal reference voltage.

The R counter output is used as the clock for the band select logic. After band selection, normal PLL action resumes. The nominal value of K_V is 50 MHz/V when the N divider is driven from the VCO output, or the K_V value is divided by D. D is the output divider value if the N divider is driven from the RF output divider.

The VCO shows variation of K_V as the tuning voltage, $VTUNE$, varies within the band and from band to band. For wideband applications covering a wide frequency range (and changing output dividers), a value of 50 MHz/V provides the most accurate K_V , because this value is closest to the average value. Figure 39 and Figure 40 shows how K_V varies with fundamental VCO frequency along with an average value for the frequency band. Users may prefer Figure 39 and Figure 40 when using narrow-band designs.

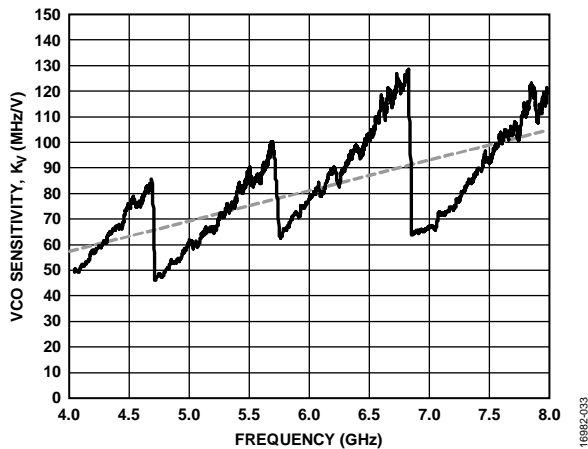

Figure 39. VCO Sensitivity, K_V vs. Frequency $VCC_VCO = 5 V$

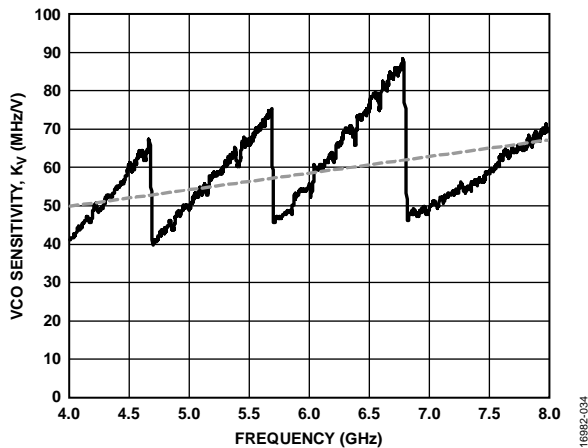

Figure 40. VCO Sensitivity, K_V vs. Frequency $VCC_VCO = 3.3 V$

OUTPUT STAGE

The RF8P and RF8N pins of the ADF4371 connect to the collectors of a bipolar negative positive negative (NPN) differential pair driven by buffered outputs of the VCO, as shown in Figure 13. The ADF4371 contains internal 50Ω resistors connected to the VCC_X1 pin. To optimize the power dissipation vs. the output power requirements, the tail current of the differential pair is programmable using Bits[1:0] in REG0025. Four current levels can be set. These levels give approximate output power levels of -4 dBm, -1 dBm, 2 dBm, and 5 dBm. Levels of -4 dBm, -1 dBm, and 2 dBm can be achieved by ac coupling into a 50Ω load. A 5 dBm level requires an external shunt inductor to VCC_X1 . An inductor has a narrower operating frequency than a 50Ω resistor. For accurate power levels, refer to the Typical Performance Characteristics section. Add an external shunt inductor to provide higher power levels, which is less wideband than the internal bias only. Terminate the unused complementary output with a circuit similar to the used output.

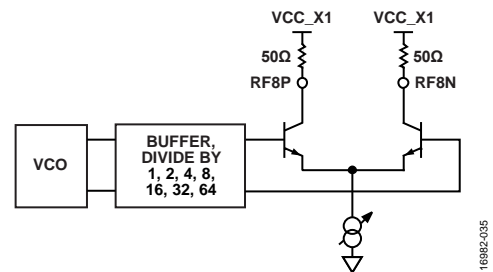

Figure 41. Output Stage

The doubled VCO output (8 GHz to 16 GHz) is available on the RF16 pin, which can be directly connected to the next circuit. The quadrupled output is available on the RF32P and RF32N pins, which can also be directly connected to the next circuit. RFAUX8P and RFAUX8N provides the same functionality as the RF8P and RF8N output, but can also output the divided RF8x frequency or the VCO frequency if desired.

DOUBLER

The VCO frequency multiplied by 2 is available at the RF16P and RF16N pins. This output can be powered down when not in use, and the pins RF16P and RF16N can be left open if unused.

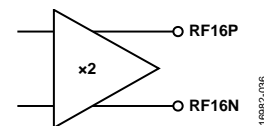

Figure 42. Doubler Output Stage

An automatic tracking filter on the ADF4371 that suppresses the VCO and other unwanted frequency products ensures the doubled output is maximized and that the VCO and $3 \times$ VCO frequencies are suppressed regardless of the output frequency. Suppression of <50 dB is typical. The optimum values are set automatically by the automatic tracking when it is enabled using Bit 1 in REG0023.

It is possible to set coefficients manually (in REG0070), such as when both the quadrupler and doubler are enabled together. The settings for optimum output power, phase noise, and harmonic rejection are given in Table 6.

Table 6. Filter and Bias Settings for Doubled Output

| Frequency (GHz) | Filter | Bias |
|-----------------|--------|------|
| <8.4 | 7 | 3 |
| 8.4 to 9.4 | 6 | 3 |
| 9.4 to 10 | 5 | 3 |
| 10 to 11.5 | 4 | 3 |
| 11.5 to 12.2 | 3 | 3 |
| 12.2 to 13.7 | 2 | 3 |
| 13.7 to 14.5 | 1 | 3 |
| >14.5 | 0 | 3 |

QUADRUPLER



Figure 43. Quadrupler Output Stage

The VCO frequency multiplied by 4 is available at the RF32P and RF32N pins. This output can be powered down when not in use, and the RF32P and RF32N pins can be left open if unused.

The ADF4371 has an automatic tracking filter that suppresses VCO, 2 × VCO, 3 × VCO, 5 × VCO, and other unwanted frequency products, regardless of the output frequency. Suppression of <30 dB is typical. The automatic tracking does not set the optimum coefficients for quadrupled output. For optimum output power, phase noise, and harmonic rejection, disable automatic selection mode (Bit 1 in REG0023) and manually load the settings in Table 7 to REG0071.

Table 7. Filter and Bias Settings for Quadrupled Output

| Frequency (GHz) | Filter | Bias |
|-----------------|--------|------|
| <18 | 7 | 3 |
| 18 to 19 | 3 | 3 |
| 19 to 20.5 | 1 | 0 |
| 20.5 to 26 | 0 | 0 |
| >26 | 0 | 1 |

Automatic tracking mode (Bit 1 in REG0023) is common for doubler and quadrupler outputs. When they are enabled together, load the filter and bias coefficients for both outputs manually for optimum performance.

OUTPUT STAGE MUTE

Another feature of the ADF4371 is that the supply current to the RF8P and RF8N output stage can shut down until the

ADF4371 achieves lock as measured by the digital lock detect circuitry. The mute to lock detect bit (MUTE_LD) in REG0025 enables this function.

SPI

The SPI of the ADF4371 allows the user to configure the device as required via a 3-wire or 4-wire SPI port. This interface provides users with added flexibility and customization. The serial port interface consists of four control lines: SCLK, SDIO, CS, and MUXOUT (not used in 3-wire SPI). The timing requirements for the SPI port are detailed in Table 2.

The SPI protocol consists of a read and write bit and 15 register address bits, followed by eight data bits. Both the address and data fields are organized with the MSB first and end with the LSB by default. The timing diagrams for write and read are shown in Figure 3 and Figure 4, respectively. The significant bit order can be changed via the REG0000 register, Bit 1 (LSB_FIRST) setting, and the related timing diagram is shown in Figure 2.

The ADF4371 input logic level for the write cycle is compatible with 1.8 V logic level (see the logic parameters in Table 1). On a read cycle, both the SDIO and MUXOUT pins are configurable for 1.8 V (default) or 3.3 V output levels by the LEV_SEL bit setting.

SPI Stream Mode

The ADF4371 supports stream mode, where data bits are loaded to or read from registers serially without writing the register address (instruction word). This mode is useful in time critical applications, when a large amount of data must be transferred or when some registers must be updated repeatedly.

The slave device starts reading or writing data to this address and continues as long as CS is asserted and single-byte writes are not enabled (Bit 7 in REG0001). The slave device automatically increments or decrements the address depending on the setting of the address ascension bit (Bit 2 in REG0000).

The diagram of 3-byte streaming is shown in Figure 5. The instruction header starts with a Logic 0 to indicate a write sequence and addresses the register. Then, the data for registers (N, N – 1, and N – 2) are loaded consecutively without any assertion in CS.

The registers are organized into eight bits, and if a register requires more than eight bits, sequential register addresses are used. This organization enables using stream mode and simplifies loading. For example, FRAC1WORD is stored in REG0016, REG0015, and REG0014 (MSB to LSB). These registers can be loaded by using REG0016 and sending the whole 24-bit data afterward, as shown in Figure 5.

DEVICE SETUP

The recommended sequence of steps to set up the ADF4371 are as follows:

1. Set up the SPI interface.
2. Perform the initialization sequence.
3. Perform the frequency update sequence.

STEP 1: SET UP THE SPI INTERFACE

First, initialize the SPI. Write the values in Table 8 to REG0000 and REG0001.

Table 8. SPI Interface Setup

| Address | Setting | Notes |
|---------|---------|-----------------------------------|
| 0x00 | 0x18 | 4-wire SPI |
| 0x01 | 0x00 | Stalling, master readback control |

STEP 2: INITIALIZATION SEQUENCE

Write to each register in reverse order from Address 0x7C to Address 0x10. Choosing appropriate values to generate the desired frequency. The frequency update sequence follows to generate the desired output frequency.

STEP 3: FREQUENCY UPDATE SEQUENCE

Frequency updates require updating MOD2, FRAC1, FRAC2, and INT. Therefore, the update sequence must be as follows:

1. REG001A (new MOD2WORD[13:8])
2. REG0019 (new MOD2WORD[7:0])
3. REG0018 (new FRAC2WORD[13:7])
4. REG0017 (new FRAC2WORD[6:0])
5. REG0016 (new FRAC1WORD[23:16])
6. REG0015 (new FRAC1WORD[15:8])
7. REG0014 (new FRAC1WORD[7:0])
8. REG0011 (new BIT_INTEGER_WORD[15:8])
9. REG0010 (new BIT_INTEGER_WORD[7:0])

The frequency change occurs on the write to REG0010.

The unchanged registers do not need to be updated. For example, for an Integer N PLL configuration (fractional parts are not used), skip Step 1 to Step 7. In this case, the only required updates are REG0011 and REG0010.

APPLICATIONS INFORMATION

POWER SUPPLIES

The ADF4371 contains four multiband VCOs that together cover an octave range of frequencies. To achieve optimal VCO phase noise performance, it is recommended to connect a low noise regulator, such as the [ADM7150](#) or [LT3045](#) to the VCC_VCO pin. Connect the same regulator to the VCC_VCO and VCC_LDO pins. 1 μ F decoupling capacitors connected to the 5 V VCO supply are recommended.

For all other the 3.3 V supply pins, use one [ADM7150](#) or one [LT3045](#) regulator. 1 μ F is also recommended for the VDD_VP pin. Additional decoupling to other supply pins is not required.

PCB DESIGN GUIDELINES FOR AN LGA PACKAGE

The bottom of the chip scale package has a central exposed thermal pad. The thermal pad on the PCB must be at least as large as the exposed pad. On the PCB, there must be a minimum clearance of 0.25 mm between the thermal pad and the inner edges of the pad pattern. This clearance ensures the avoidance of shorting.

To improve the thermal performance of the package, use thermal vias on the PCB thermal pad. If vias are used, incorporate them into the thermal pad at the 1.2 mm pitch grid. The via diameter must be between 0.3 mm and 0.33 mm, and the via barrel must be plated with 1 oz. of copper to plug the via.

For a microwave PLL and VCO synthesizer, such as the ADF4371, take care with the board stackup and layout. Do not consider using FR4 material because it causes an amplitude decrease in signals greater than 3 GHz. Instead, Rogers 4350, Rogers 4003, or Rogers 3003 dielectric material is suitable.

Take care with the RF output traces to minimize discontinuities and ensure the best signal integrity. Via placement and grounding are critical.

OUTPUT MATCHING

The low frequency output can be ac-coupled to the next circuit, if desired. However, if higher output power is required, use a pull-up inductor to increase the output power level.

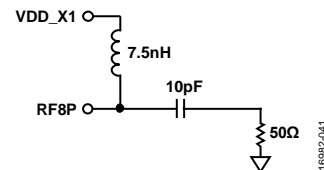

Figure 44. Optimum Output Stage

When differential outputs are not needed, terminate the unused output or combine it with both outputs using a balun.

For lower frequencies less than 1 GHz, it is recommended to use a 100 nH inductor on the RF8P and RF8N pins.

The RF8P and RF8N pins form a differential circuit. Provide each output with the same (or similar) components where possible, including the same shunt inductor value, bypass capacitor, and termination.

The RFAUX8P and RFAUX8N pins are effectively the same as RF8P and RF8N and must be treated in the manner as outlined for RF8P and RF8N.

The RF16P and RF16N pins and the RF32P and RF32N pins can be directly connected to the next circuit stage. These pins are internally matched to 50 Ω and do not require additional decoupling.

REGISTER SUMMARY

Table 9. ADF4371 Register Summary

| Reg | Bits | Bit 7 | Bit 6 | Bit 5 | Bit 4 | Bit 3 | Bit 2 | Bit 1 | Bit 0 | Default | RW | | |
|------|-------|------------------------|----------------------|-------------------------|----------------------|----------------------|---------------------|----------------------|-------------------------|-------------|------|------|-----|
| 0x00 | [7:0] | SOFT_RESET_R | LSB_FIRST_R | ADDRESS_ASCENSION_R | SDO_ACTIVE_R | SDO_ACTIVE | ADDRESS_ASCENSION | LSB_FIRST | SOFT_RESET | 0x18 | R/W | | |
| 0x01 | [7:0] | SINGLE_INSTRUCTION | STALLING | MASTER_READBACK_CONTROL | RESERVED | | | | | | 0x00 | R/W | |
| 0x03 | [7:0] | RESERVED | | | | | CHIP_TYPE | | | | | 0x0X | R |
| 0x04 | [7:0] | PRODUCT_ID[7:0] | | | | | | | | | 0xXX | R/W | |
| 0x05 | [7:0] | PRODUCT_ID[15:8] | | | | | | | | | 0xXX | R/W | |
| 0x06 | [7:0] | PRODUCT_GRADE | | | | | DEVICE_REVISION | | | | | 0xXX | R |
| 0x10 | [7:0] | BIT_INTEGER_WORD[7:0] | | | | | | | | | 0x32 | R/W | |
| 0x11 | [7:0] | BIT_INTEGER_WORD[15:8] | | | | | | | | | 0x00 | R/W | |
| 0x12 | [7:0] | RESERVED | EN_AUTOCAL | PRE_SEL | RESERVED | | | | | | 0x40 | R/W | |
| 0x14 | [7:0] | FRAC1WORD[7:0] | | | | | | | | | 0x00 | R/W | |
| 0x15 | [7:0] | FRAC1WORD[15:8] | | | | | | | | | 0x00 | R/W | |
| 0x16 | [7:0] | FRAC1WORD[23:16] | | | | | | | | | 0x00 | R/W | |
| 0x17 | [7:0] | FRAC2WORD[6:0] | | | | | | | FRAC1WORD[24] | | 0x00 | R/W | |
| 0x18 | [7:0] | RESERVED | FRAC2WORD[13:7] | | | | | | | | 0x00 | R/W | |
| 0x19 | [7:0] | MOD2WORD[7:0] | | | | | | | | | 0xE8 | R/W | |
| 0x1A | [7:0] | RESERVED | PHASE_ADJ | MOD2WORD[13:8] | | | | | | 0x03 | R/W | | |
| 0x1B | [7:0] | PHASE_WORD[7:0] | | | | | | | | | 0x00 | R/W | |
| 0x1C | [7:0] | PHASE_WORD[15:8] | | | | | | | | | 0x00 | R/W | |
| 0x1D | [7:0] | PHASE_WORD[23:16] | | | | | | | | | 0x00 | R/W | |
| 0x1E | [7:0] | CP_CURRENT | | | | PD_POL | PD | RESERVED | CNTR_RESET | 0x48 | R/W | | |
| 0x1F | [7:0] | RESERVED | | | | R_WORD | | | | | 0x01 | R/W | |
| 0x20 | [7:0] | MUXOUT | | | | MUXOUT_EN | LEV_SEL | RESERVED | | | | 0x14 | R/W |
| 0x22 | [7:0] | RESERVED | REFIN_MODE | REF_DOUB | RDIV2 | RESERVED | | | | | 0x00 | R/W | |
| 0x23 | [7:0] | RESERVED | | | CLK_DIV_MODE | | RESERVED | | TRACKING_FILTER_MUX_SEL | RESERVED | 0x00 | R/W | |
| 0x24 | [7:0] | FB_SEL | DIV_SEL | | | | RESERVED | | | | | 0x80 | R/W |
| 0x25 | [7:0] | MUTE_LD | RESERVED | RF_DIVSEL_DB | X4_EN | X2_EN | RF_EN | RF_OUT_POWER | | | | 0x07 | R/W |
| 0x26 | [7:0] | BLEED_ICP | | | | | | | | | 0x32 | R/W | |
| 0x27 | [7:0] | LD_BIAS | | LDP | BLEED_GATE | BLEED_EN | VCOLD0_PD | RF_PBS | | | 0xC5 | R/W | |
| 0x28 | [7:0] | DOUBLE_BUFFER | RESERVED | | | | LD_COUNT | | LOL_EN | | | 0x03 | R/W |
| 0x2A | [7:0] | RESERVED | | | BLEED_POL | RESERVED | LE_SEL | RESERVED | | READ_SEL | 0x00 | R/W | |
| 0x2B | [7:0] | RESERVED | | | LSB_P1 | VAR_MOD_EN | RESERVED | SD_LOAD_ENB | RESERVED | SD_EN_FRACO | 0x01 | R/W | |
| 0x2C | [7:0] | RESERVED | ALC_RECT_SELECT_VCO1 | ALC_REF_DAC_LO_VCO1 | ALC_REF_DAC_NOM_VCO1 | | | VTUNE_CALSET_EN | DISABLE_ALC | 0x44 | R/W | | |
| 0x2D | [7:0] | RESERVED | | | | ALC_RECT_SELECT_VCO2 | ALC_REF_DAC_LO_VCO2 | ALC_REF_DAC_NOM_VCO2 | | | | 0x11 | R/W |
| 0x2E | [7:0] | RESERVED | | | | ALC_RECT_SELECT_VCO3 | ALC_REF_DAC_LO_VCO3 | ALC_REF_DAC_NOM_VCO3 | | | | 0x12 | R/W |
| 0x2F | [7:0] | SWITCH_LDO_3P3V_5V | RESERVED | | | ALC_RECT_SELECT_VCO4 | ALC_REF_DAC_LO_VCO4 | ALC_REF_DAC_NOM_VCO4 | | | | 0x94 | R/W |
| 0x30 | [7:0] | VCO_BAND_DIV | | | | | | | | | 0x3F | R/W | |
| 0x31 | [7:0] | TIMEOUT[7:0] | | | | | | | | | 0xA7 | R/W | |
| 0x32 | [7:0] | ADC_MUX_SEL | RESERVED | ADC_FAST_CONV | ADC_CTS_CONV | ADC_CONVERSION | ADC_ENABLE | TIMEOUT[9:8] | | | 0x04 | R/W | |
| 0x33 | [7:0] | RESERVED | | | | SYNTH_LOCK_TIMEOUT | | | | | | 0x0C | R/W |
| 0x34 | [7:0] | VCO_FSM_TEST_MODES | | | | VCO_ALC_TIMEOUT | | | | | | 0x9E | R/W |
| 0x35 | [7:0] | ADC_CLK_DIVIDER | | | | | | | | | 0x4C | R/W | |
| 0x36 | [7:0] | ICP_ADJUST_OFFSET | | | | | | | | | 0x30 | R/W | |
| 0x37 | [7:0] | SI_BAND_SEL | | | | | | | | | 0x00 | R/W | |
| 0x38 | [7:0] | SI_VCO_SEL | | | | | SI_VCO_BIAS_CODE | | | | | 0x00 | R/W |
| 0x39 | [7:0] | RESERVED | VCO_FSM_TEST_MUX_SEL | | | | SI_VTUNE_CAL_SET | | | | 0x07 | R/W | |
| 0x3A | [7:0] | ADC_OFFSET | | | | | | | | | 0x55 | R/W | |
| 0x3D | [7:0] | RESERVED | SD_RESET | RESERVED | | | | | | | 0x00 | R/W | |

| Reg | Bits | Bit 7 | Bit 6 | Bit 5 | Bit 4 | Bit 3 | Bit 2 | Bit 1 | Bit 0 | Default | RW | |
|------|-------|-------------------------|----------------|----------|----------------------|----------------|-----------------|-------------|----------------------|---------|------|-----|
| 0x3E | [7:0] | RESERVED | | | CP_TMODE | | RESERVED | | | 0x0C | R/W | |
| 0x3F | [7:0] | CLK1_DIV[7:0] | | | | | | | | | 0x80 | R/W |
| 0x40 | [7:0] | RESERVED | TRM_IB_VCO_BUF | | | CLK1_DIV[11:8] | | | | | 0x50 | R/W |
| 0x41 | [7:0] | CLK2_DIVIDER_1[7:0] | | | | | | | | | 0x28 | R/W |
| 0x42 | [7:0] | CLK2_DIVIDER_2[3:0] | | | CLK2_DIVIDER_1[11:8] | | | | | 0x00 | R/W | |
| 0x47 | [7:0] | TRM_RESV_VCO_MUX | | | RESERVED | | | | | 0xC0 | R/W | |
| 0x52 | [7:0] | TRM_RESV_VCO_BUF | | | TRM_RESC_VCO_BUF | | | RESERVED | | | 0xF4 | R/W |
| 0x6E | [7:0] | VCO_DATA_READBACK[7:0] | | | | | | | | | 0x00 | R |
| 0x6F | [7:0] | VCO_DATA_READBACK[15:8] | | | | | | | | | 0x00 | R |
| 0x70 | [7:0] | BAND_SEL_X2 | | | RESERVED | | | BIAS_SEL_X2 | | | 0x03 | R/W |
| 0x71 | [7:0] | BAND_SEL_X4 | | | RESERVED | | | BIAS_SEL_X4 | | | 0x60 | R/W |
| 0x72 | [7:0] | RESERVED | AUX_FREQ_SEL | POUT_AUX | | PDB_AUX | RESERVED | COUPLED_VCO | RESERVED | 0x32 | R/W | |
| 0x73 | [7:0] | RESERVED | | | | | ADC_CLK_DISABLE | PD_NDIV | LD_DIV | 0x00 | R/W | |
| 0x7C | [7:0] | RESERVED | | | | | | | LOCK_DETECT_READBACK | 0x00 | R | |

REGISTER DETAILS

Address: 0x00, Default: 0x18, Name: REG0000

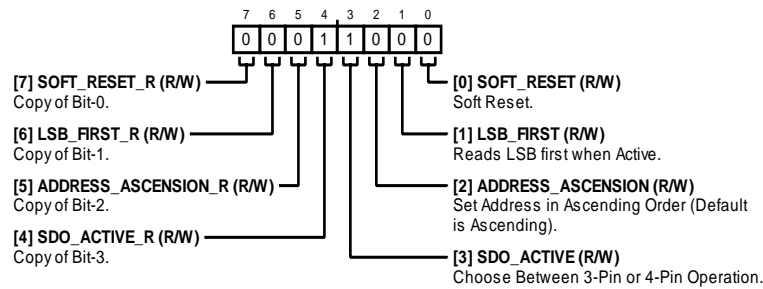

Table 10. Bit Descriptions for REG0000

| Bit(s) | Bit Name | Description | Default | Access |
|--------|---------------------|---|---------|--------|
| 7 | SOFT_RESET_R | Copy of Bit 0. | 0x0 | R/W |
| 6 | LSB_FIRST_R | Copy of Bit 1. | 0x0 | R/W |
| 5 | ADDRESS_ASCENSION_R | Copy of Bit 2. | 0x0 | R/W |
| 4 | SDO_ACTIVE_R | Copy of Bit 3. | 0x1 | R/W |
| 3 | SDO_ACTIVE | Choose Between 3-Pin or 4-Pin Operation. 0: 3-pin. 1: 4-pin. Enables SDIO pin and the SDIO pin becomes an input only. | 0x1 | R/W |
| 2 | ADDRESS_ASCENSION | Set Address in Ascending Order (Default Is Ascending). 0: descending. 1: ascending. | 0x0 | R/W |
| 1 | LSB_FIRST | Reads LSB First when Active. | 0x0 | R/W |
| 0 | SOFT_RESET | Soft Reset. 0: normal operation. 1: soft reset. | 0x0 | R/W |

Address: 0x01, Default: 0x00, Name: REG0001

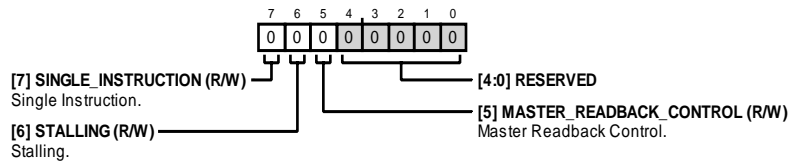

Table 11. Bit Descriptions for REG0001

| Bit(s) | Bit Name | Description | Default | Access |
|--------|-------------------------|--|---------|--------|
| 7 | SINGLE_INSTRUCTION | Single Instruction. SPI stream mode is disabled if this bit is set to 1. | 0x0 | R/W |
| 6 | STALLING | Stalling. | 0x0 | R/W |
| 5 | MASTER_READBACK_CONTROL | Master Readback Control. | 0x0 | R/W |
| [4:0] | RESERVED | Reserved. | 0x0 | R |

Address: 0x03, Default: 0x0X, Name: REG0003

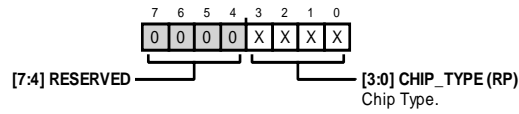

Table 12. Bit Descriptions for REG0003

| Bit(s) | Bit Name | Description | Default | Access |
|--------|-----------|-------------|---------|--------|
| [7:4] | RESERVED | Reserved. | 0x0 | R |
| [3:0] | CHIP_TYPE | Chip Type. | Prog | RP |

Address: 0x04, Default: 0xXX, Name: REG0004

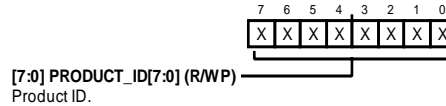

Table 13. Bit Descriptions for REG0004

| Bit(s) | Bit Name | Description | Default | Access |
|--------|-----------------|-------------|---------|--------|
| [7:0] | PRODUCT_ID[7:0] | Product ID. | Prog | R/WP |

Address: 0x05, Default: 0xXX, Name: REG0005

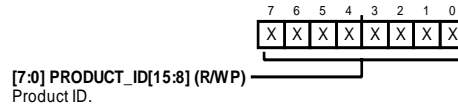

Table 14. Bit Descriptions for REG0005

| Bit(s) | Bit Name | Description | Default | Access |
|--------|------------------|-------------|---------|--------|
| [7:0] | PRODUCT_ID[15:8] | Product ID. | Prog | R/WP |

Address: 0x06, Default: 0xXX, Name: REG0006



Table 15. Bit Descriptions for REG0006

| Bit(s) | Bit Name | Description | Default | Access |
|--------|-----------------|------------------|---------|--------|
| [7:4] | PRODUCT_GRADE | Product Grade. | Prog | RP |
| [3:0] | DEVICE_REVISION | Device Revision. | Prog | RP |

Address: 0x10, Default: 0x32, Name: REG0010



Table 16. Bit Descriptions for REG0010

| Bit(s) | Bit Name | Description | Default | Access |
|--------|-----------------------|---|---------|--------|
| [7:0] | BIT_INTEGER_WORD[7:0] | 16-Bit Integer Word. Sets the integer value of N. Updates to the PLL N counter, including FRAC1, FRAC2, and MOD2, are double buffered by this bitfield. | 0x32 | R/W |

Address: 0x11, Default: 0x00, Name: REG0011

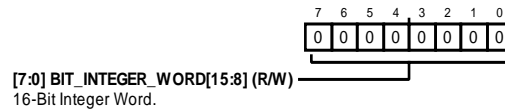

Table 17. Bit Descriptions for REG0011

| Bit(s) | Bit Name | Description | Default | Access |
|--------|------------------------|---|---------|--------|
| [7:0] | BIT_INTEGER_WORD[15:8] | 16-Bit Integer Word. Sets the integer value of N. Updates to the PLL N counter, including FRAC1, FRAC2, and MOD2, are double buffered by this bitfield. | 0x0 | R/W |

Address: 0x12, Default: 0x40, Name: REG0012

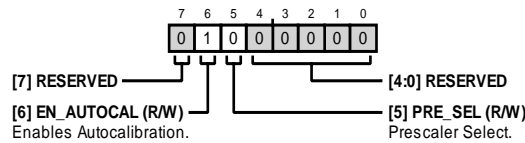

Table 18. Bit Descriptions for REG0012

| Bit(s) | Bit Name | Description | Default | Access |
|--------|------------|--|---------|--------|
| 7 | RESERVED | Reserved. | 0x0 | R |
| 6 | EN_AUTOCAL | Enables Autocalibration. 0: VCO autocalibration disabled. 1: VCO autocalibration enabled. | 0x1 | R/W |
| 5 | PRE_SEL | Prescaler Select. The dual modulus prescaler is set by this bit. The prescaler, at the input to the N divider, divides down the VCO signal so the N divider can handle it. The prescaler setting affects the RF frequency and the minimum and maximum INT value. 0: 4/5 prescaler. 1: 8/9 prescaler. | 0x0 | R/W |
| [4:0] | RESERVED | Reserved. | 0x0 | R |

Address: 0x14, Default: 0x00, Name: REG0014

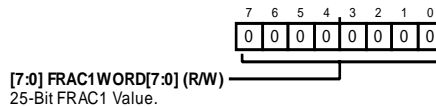

Table 19. Bit Descriptions for REG0014

| Bit(s) | Bit Name | Description | Default | Access |
|--------|----------------|---|---------|--------|
| [7:0] | FRAC1WORD[7:0] | 25-Bit FRAC1 Value. Sets the FRAC1 value. | 0x0 | R/W |

Address: 0x15, Default: 0x00, Name: REG0015

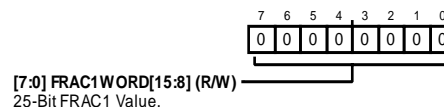

Table 20. Bit Descriptions for REG0015

| Bit(s) | Bit Name | Description | Default | Access |
|--------|-----------------|---|---------|--------|
| [7:0] | FRAC1WORD[15:8] | 25-Bit FRAC1 Value. Sets the FRAC1 value. | 0x0 | R/W |

Address: 0x16, Default: 0x00, Name: REG0016

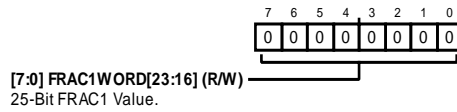

Table 21. Bit Descriptions for REG0016

| Bit(s) | Bit Name | Description | Default | Access |
|--------|------------------|---|---------|--------|
| [7:0] | FRAC1WORD[23:16] | 25-Bit FRAC1 Value. Sets the FRAC1 value. | 0x0 | R/W |

Address: 0x17, Default: 0x00, Name: REG0017

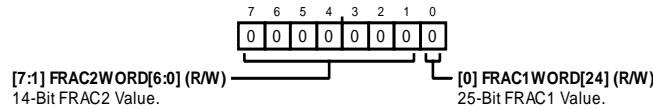

Table 22. Bit Descriptions for REG0017

| Bit(s) | Bit Name | Description | Default | Access |
|--------|------------------|---|---------|--------|
| [7:1] | FRAC2WORD[6:0] | 14-Bit FRAC2 Value. Sets the FRAC2 value. | 0x0 | R/W |
| 0 | FRAC1WORD[24:24] | 25-Bit FRAC1 Value. Sets the FRAC1 value. | 0x0 | R/W |

Address: 0x18, Default: 0x00, Name: REG0018

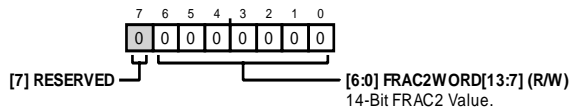

Table 23. Bit Descriptions for REG0018

| Bit(s) | Bit Name | Description | Default | Access |
|--------|-----------------|---|---------|--------|
| 7 | RESERVED | Reserved. | 0x0 | R |
| [6:0] | FRAC2WORD[13:7] | 14-Bit FRAC2 Value. Sets the FRAC2 value. | 0x0 | R/W |

Address: 0x19, Default: 0xE8, Name: REG0019

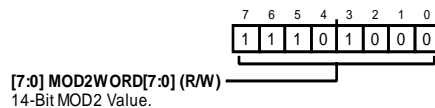

Table 24. Bit Descriptions for REG0019

| Bit(s) | Bit Name | Description | Default | Access |
|--------|---------------|---|---------|--------|
| [7:0] | MOD2WORD[7:0] | 14-Bit MOD2 Value. Sets the MOD2 value. | 0xE8 | R/W |

Address: 0x1A, Default: 0x03, Name: REG001A



Table 25. Bit Descriptions for REG001A

| Bit(s) | Bit Name | Description | Default | Access |
|--------|----------------|--|---------|--------|
| 7 | RESERVED | Reserved. | 0x0 | R |
| 6 | PHASE_ADJ | Phase Adjust Enable. Set to 1 to enable phase adjust. Phase adjust increases the phase of the output relative to the current phase. 0: phase adjust disabled. 1: phase adjust enabled. | 0x0 | R/W |
| [5:0] | MOD2WORD[13:8] | 14-Bit MOD2 Value. Sets the MOD2 value. | 0x3 | R/W |

Address: 0x1B, Default: 0x00, Name: REG001B



Table 26. Bit Descriptions for REG001B

| Bit(s) | Bit Name | Description | Default | Access |
|--------|-----------------|---|---------|--------|
| [7:0] | PHASE_WORD[7:0] | 24-Bit Phase Value. Sets the phase word for phase adjust. If phase adjust is not used, set phase value to 0. The phase of the RF output frequency can be adjusted in 24-bit steps. Phase step = Phase Word ÷ 16,777,216 × 360°. | 0x0 | R/W |

Address: 0x1C, Default: 0x00, Name: REG001C

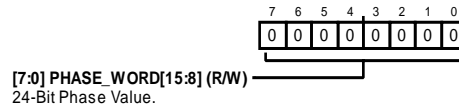

Table 27. Bit Descriptions for REG001C

| Bit(s) | Bit Name | Description | Default | Access |
|--------|------------------|---|---------|--------|
| [7:0] | PHASE_WORD[15:8] | 24-Bit Phase Value. Sets the phase word for phase adjust. If phase adjust is not used, set phase value to 0. The phase of the RF output frequency can be adjusted in 24-bit steps. Phase step = Phase Word ÷ 16,777,216 × 360°. | 0x0 | R/W |

Address: 0x1D, Default: 0x00, Name: REG001D

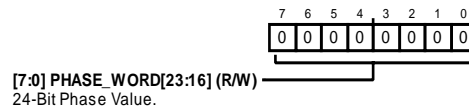

Table 28. Bit Descriptions for REG001D

| Bit(s) | Bit Name | Description | Default | Access |
|--------|-------------------|---|---------|--------|
| [7:0] | PHASE_WORD[23:16] | 24-Bit Phase Value. Sets the phase word for phase adjust. If phase adjust is not used, set phase value to 0. The phase of the RF output frequency can be adjusted in 24-bit steps. Phase step = Phase Word ÷ 16,777,216 × 360°. | 0x0 | R/W |

Address: 0x1E, Default: 0x48, Name: REG001E



Table 29. Bit Descriptions for REG001E

| Bit(s) | Bit Name | Description | Default | Access |
|--------|------------|--|---------|--------|
| [7:4] | CP_CURRENT | Charge Pump Current Setting. Sets the charge pump current. Set these bits to the charge pump current that the loop filter is designed for. 0: 0.35 mA. 1: 0.70 mA. 10: 1.05 mA. 11: 1.4 mA. 100: 1.75 mA. 101: 2.8 mA. 110: 2.45 mA. 111: 2.8 mA. 1000: 3.15 mA. 1001: 3.5 mA. 1010: 3.85 mA. 1011: 4.2 mA. 1100: 4.55 mA. 1101: 4.9 mA. 1110: 5.25 mA. 1111: 5.6 mA. | 0x4 | R/W |
| 3 | PD_POL | Phase Detector Polarity. If using a noninverting loop filter and a VCO with positive tuning slope, set phase detector polarity to positive. If using an inverting loop filter and a VCO with a negative tuning slope, set phase detector polarity to positive. If using a noninverting loop filter and a VCO with a negative tuning slope, set phase detector polarity to negative. If using an inverting loop filter and a VCO with a positive tuning slope, set phase detector polarity to negative. 0: negative phase detector polarity. 1: positive phase detector polarity. | 0x1 | R/W |
| 2 | PD | Power-Down. Setting to 1 powers down all internal PLL blocks of the ADF4371. The VCO and multipliers remain powered up. The registers do not lose their values. After bringing the ADF4371 out of power-down (setting to 0) a write to REG0010 is required to relock the loop. 0: normal operation. 1: power-down. | 0x0 | R/W |
| 1 | RESERVED | Reserved. | 0x0 | R |
| 0 | CNTR_RESET | Counter Reset. Setting to 1 holds the N divider and R counter in reset. There are no signals entering the PFD. 0: normal operation. 1: counter reset. | 0x0 | R/W |

Address: 0x1F, Default: 0x01, Name: REG001F



Table 30. Bit Descriptions for REG001F

| Bit(s) | Bit Name | Description | Default | Access |
|--------|----------|------------------|---------|--------|
| [7:5] | RESERVED | Reserved. | 0x0 | R |
| [4:0] | R_WORD | 5-Bit R Counter. | 0x1 | R/W |

Address: 0x20, Default: 0x14, Name: REG0020



Table 31. Bit Descriptions for REG0020

| Bit(s) | Bit Name | Description | Default | Access |
|--------|-----------|--|---------|--------|
| [7:4] | MUXOUT | Mux Out. Is used to set the mux out signal when MUXOUT_EN = 1. 0: tristate, high impedance output (only works when MUXOUT_EN = 0). 1: digital lock detect. 10: charge pump up. 11: charge pump down. 100: RDIV2. 101: N divider output. 110: VCO test modes. 111: Reserved. 1000: high. 1001: VCO calibration R band/2. 1010: VCO calibration N band/2. | 0x1 | R/W |
| 3 | MUXOUT_EN | Mux Out Enable. Set to 0 if using the SDIO pin for register readback. 0: data pin used for readback. 1: mux out pin used for readback. | 0x0 | R/W |
| 2 | LEV_SEL | Mux Out Level Select. Select the voltage level of the logic at the mux out. 0: 1.8 V logic. 1: 3.3 V logic. | 0x1 | R/W |
| [1:0] | RESERVED | Reserved. | 0x0 | R |

Address: 0x22, Default: 0x00, Name: REG0022

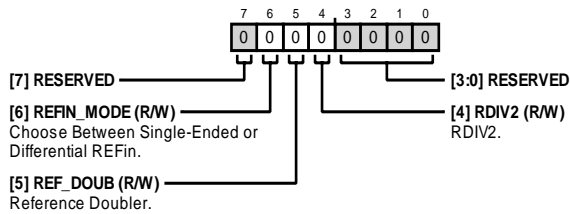

Table 32. Bit Descriptions for REG0022

| Bit(s) | Bit Name | Description | Default | Access |
|--------|------------|---|---------|--------|
| 7 | RESERVED | Reserved. | 0x0 | R |
| 6 | REFIN_MODE | Choose Between Single-Ended or Differential REFin. 0: single-ended REFin. 1: differential REFin. | 0x0 | R/W |
| 5 | REF_DOUB | Reference Doubler. Controls the reference doubler block. 0: doubler disabled. 1: doubler enabled. | 0x0 | R/W |
| 4 | RDIV2 | RDIV2. Controls the reference divide by 2 clock. This feature can be used to provide a 50% duty cycle signal to the PFD. 0: RDIV2 disabled. 1: RDIV2 enabled. | 0x0 | R/W |
| [3:0] | RESERVED | Reserved. | 0x0 | R |

Address: 0x23, Default: 0x00, Name: REG0023

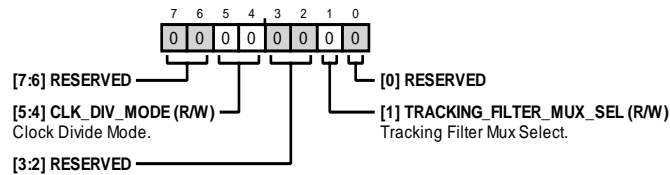

Table 33. Bit Descriptions for REG0023

| Bit(s) | Bit Name | Description | Default | Access |
|--------|-------------------------|--|---------|--------|
| [7:6] | RESERVED | Reserved. | 0x0 | R |
| [5:4] | CLK_DIV_MODE | Clock Divide Mode. Set to 10 to enable phase resynchronization. When not using phase resynchronization, set to 00. 0: clock divider off (normal operation). 10: resynchronization enabled. | 0x0 | R/W |
| [3:2] | RESERVED | Reserved. | 0x0 | R |
| 1 | TRACKING_FILTER_MUX_SEL | Tracking Filter Mux Select. 0: normal, tracking filter coefficients set automatically. 1: tracking filter coefficients set manually from SPI (REG0070 and REG0071). | 0x0 | R/W |
| 0 | RESERVED | Reserved. | 0x0 | R |

Address: 0x24, Default: 0x80, Name: REG0024

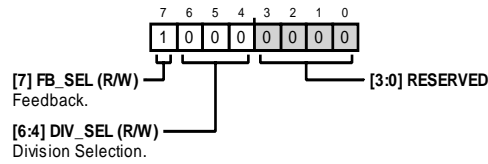

Table 34. Bit Descriptions for REG0024

| Bit(s) | Bit Name | Description | Default | Access |
|--------|----------|--|---------|--------|
| 7 | FB_SEL | Feedback. 0: divider feedback to N counter. 1: fundamental feedback to N counter. | 0x1 | R/W |
| [6:4] | DIV_SEL | Division Selection. 0: divide 1. 1: divide 2. 10: divide 4. 11: divide 8. 100: divide 16. 101: divide 32. 110: divide 64. 111: reserved. | 0x0 | R/W |
| [3:0] | RESERVED | Reserved. | 0x0 | R |

Address: 0x25, Default: 0x07, Name: REG0025

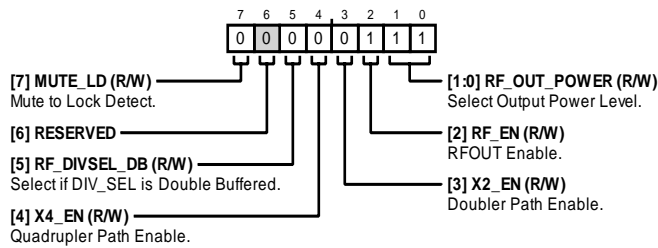

Table 35. Bit Descriptions for REG0025

| Bit(s) | Bit Name | Description | Default | Access |
|--------|--------------|--|---------|--------|
| 7 | MUTE_LD | Mute to Lock Detect. 0: mute to lock detect disabled. 1: mute to lock detect enabled, RF output stage gated by digital lock detect asserting logic high. | 0x0 | R/W |
| 6 | RESERVED | Reserved. | 0x0 | R |
| 5 | RF_DIVSEL_DB | Select if DIV_SEL is Double Buffered. | 0x0 | R/W |
| 4 | X4_EN | Quadrupler Path Enable. 0: RF quadrupler off. 1: RF quadrupler on. | 0x0 | R/W |
| 3 | X2_EN | Doubler Path Enable. 0: RF doubler off. 1: RF doubler on. | 0x0 | R/W |
| 2 | RF_EN | RF _{OUT} Enable. 0: RF _{OUT} disabled. 1: RF _{OUT} enabled. | 0x1 | R/W |

| Bit(s) | Bit Name | Description | Default | Access |
|--------|--------------|--|---------|--------|
| [1:0] | RF_OUT_POWER | Select Output Power Level. 0: -4 dBm. 1: -1 dBm. 10: 2 dBm. 11: 5 dBm. | 0x3 | R/W |

Address: 0x26, Default: 0x32, Name: REG0026



Table 36. Bit Descriptions for REG0026

| Bit(s) | Bit Name | Description | Default | Access |
|--------|-----------|--|---------|--------|
| [7:0] | BLEED_ICP | Bleed Current. Sets the bleed current. The optimum bleed current is set by $((4/N) \times I_{CP})/3.75$, where I_{CP} is the charge pump current in μA . | 0x32 | R/W |

Address: 0x27, Default: 0xC5, Name: REG0027

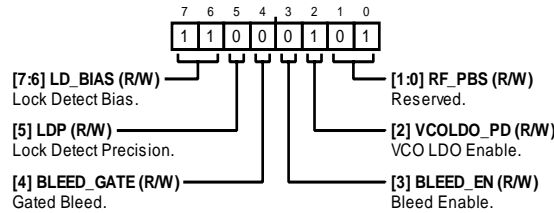

Table 37. Bit Descriptions for REG0027

| Bit(s) | Bit Name | Description | Default | Access |
|--------|------------|---|---------|--------|
| [7:6] | LD_BIAS | Lock Detect Bias. The lock detector window size is set by adjusting the lock detector bias in conjunction with the lock detector precision. 0: 5 ns lock detect delay if LDP = 0. 1: 6 ns. 10: 8 ns. 11: 12 ns lock detect delay (for large values of bleed) | 0x3 | R/W |
| 5 | LDP | Lock Detect Precision. Controls the sensitivity of the digital lock detector, depending on INT or FRAC operation selected. 0: FRAC Mode (5 ns). 1: INT Mode (2.4 ns). | 0x0 | R/W |
| 4 | BLEED_GATE | Gated Bleed. 0: gate bleed disabled. 1: gate bleed on, digital lock detect (digital lock detect must be enabled) | 0x0 | R/W |
| 3 | BLEED_EN | Bleed Enable. Bleed current applies to a current inside the charge pump to improve the linearity of the charge pump. This current leads to lower phase noise and improved spurious performance. Set to 1 to enable negative bleed. 0: negative bleed disabled. 1: negative bleed enabled. | 0x0 | R/W |
| 2 | VCOLD0_PD | VCO LDO Enable. For optimal spurious and phase noise performance, disable VCO LDO. 0: VCO LDO enabled. 1: VCO LDO disabled. | 0x1 | R/W |
| [1:0] | RF_PBS | Reserved. | 0x1 | R/W |

Address: 0x28, Default: 0x03, Name: REG0028

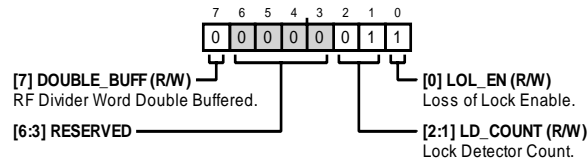

Table 38. Bit Descriptions for REG0028

| Bit(s) | Bit Name | Description | Default | Access |
|--------|-------------|---|---------|--------|
| 7 | DOUBLE_BUFF | RF Divider Word Double Buffered. 0: normal operation. 1: RF divider word double buffered. | 0x0 | R/W |
| [6:3] | RESERVED | Reserved. | 0x0 | R |
| [2:1] | LD_COUNT | Lock Detector Count. Initial value of the lock detector. This field sets the number of counts of PFD within lock window before asserting digital lock detect high. 0: 1024 cycles. 1: 2048 cycles. 10: 4096 cycles. 11: 8192 cycles. | 0x1 | R/W |
| 0 | LOL_EN | Loss of Lock Enable. When loss of lock is enabled, if digital lock detect is asserted, and the reference signal is removed, digital lock detect goes low. It is recommended to set to 1 to enable loss of lock. 0: disabled. 1: loss of lock enabled. | 0x1 | R/W |

Address: 0x2A, Default: 0x00, Name: REG002A

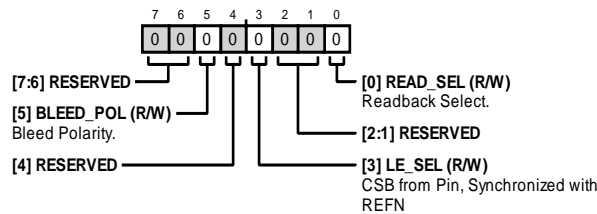

Table 39. Bit Descriptions for REG002A

| Bit(s) | Bit Name | Description | Default | Access |
|--------|-----------|--|---------|--------|
| [7:6] | RESERVED | Reserved. | 0x0 | R |
| 5 | BLEED_POL | Bleed Polarity. Controls the polarity of the bleed current. Negative is typical usage. 0: negative bleed. 1: positive bleed (not recommended). | 0x0 | R/W |
| 4 | RESERVED | Reserved. | 0x0 | R |
| 3 | LE_SEL | CSB from Pin, Synchronized with REFN. 0: CSB synchronization disabled. 1: CSB synchronization enabled. | 0x0 | R/W |
| [2:1] | RESERVED | Reserved. | 0x0 | R |
| 0 | READ_SEL | Readback Select. Selects the value to be read back. 0: readback VCO, band, and bias compensation data. 1: readback device version ID. | 0x0 | R/W |

Address: 0x2B, Default: 0x01, Name: REG002B



Table 40. Bit Descriptions for REG002B

| Bit(s) | Bit Name | Description | Default | Access |
|--------|-------------|--|---------|--------|
| [7:6] | RESERVED | Reserved. | 0x0 | R |
| 5 | LSB_P1 | Adds a half bit to FRAC1 when auxiliary SDM is off (VAR_MOD_EN = 0). Set to 0 for normal operation. | 0x0 | R/W |
| 4 | VAR_MOD_EN | Enable Auxiliary SDM. If FRAC2 = 0, this bit programmed to 1. 0: normal operation. 1: enable auxiliary SDM. | 0x1 | R/W |
| 3 | RESERVED | Reserved. | 0x0 | R |
| 2 | SD_LOAD_ENB | Mask $\Sigma\Delta$ Reset when REG0010 is updated. | 0x0 | R/W |
| 1 | RESERVED | Reserved. | 0x0 | R |
| 0 | SD_EN_FRACO | $\Sigma\Delta$ Enable. Set to 1 when in INT mode (when FRAC1 = FRAC2 = 0), and set to 0 when in FRAC mode. 0: $\Sigma\Delta$ enabled (for fractional mode). 1: $\Sigma\Delta$ disabled (for integer mode). | 0x1 | R/W |

Address: 0x2C, Default: 0x44, Name: REG002C

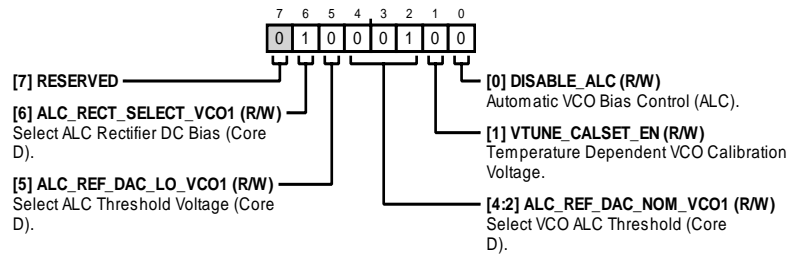

Table 41. Bit Descriptions for REG002C

| Bit(s) | Bit Name | Description | Default | Access |
|--------|----------------------|---|---------|--------|
| 7 | RESERVED | Reserved. | 0x0 | R |
| 6 | ALC_RECT_SELECT_VCO1 | Select ALC Rectifier DC Bias (Core D). 0: 3.3 V VCO operation. 1: 5 V VCO operation. | 0x1 | R/W |
| 5 | ALC_REF_DAC_LO_VCO1 | Select ALC Threshold Voltage (Core D). 0: 5 V VCO operation. 1: 3.3 V VCO operation. | 0x0 | R/W |
| [4:2] | ALC_REF_DAC_NOM_VCO1 | Select VCO ALC Threshold (Core D). 001: 3.3 V and 5 V VCO operation. | 0x1 | R/W |
| 1 | VTUNE_CALSET_EN | Temperature Dependent VCO Calibration Voltage. 0: disable temperature dependent VCO calibration voltage. 1: enable temperature dependent VCO calibration voltage. | 0x0 | R/W |
| 0 | DISABLE_ALC | Automatic VCO Bias Control (ALC). 0: ALC enabled. 1: ALC disabled. | 0x0 | R/W |

Address: 0x2D, Default: 0x11, Name: REG002D



Table 42. Bit Descriptions for REG002D

| Bit(s) | Bit Name | Description | Default | Access |
|--------|----------------------|--|---------|--------|
| [7:5] | RESERVED | Reserved. | 0x0 | R |
| 4 | ALC_RECT_SELECT_VCO2 | Sets ALC Rectifier DC Bias (Core C). 0: 3.3 V VCO operation. 1: 5 V VCO operation. | 0x1 | R/W |
| 3 | ALC_REF_DAC_LO_VCO2 | Select ALC Threshold Voltage (Core C). 0: 5 V VCO operation. 1: 3.3 V VCO operation. | 0x0 | R/W |
| [2:0] | ALC_REF_DAC_NOM_VCO2 | Select VCO ALC Threshold (Core C). 001: 3.3 V and 5 V VCO operation. | 0x1 | R/W |

Address: 0x2E, Default: 0x12, Name: REG002E



Table 43. Bit Descriptions for REG002E

| Bit(s) | Bit Name | Description | Default | Access |
|--------|----------------------|--|---------|--------|
| [7:5] | RESERVED | Reserved. | 0x0 | R |
| 4 | ALC_RECT_SELECT_VCO3 | Sets ALC Rectifier DC Bias (Core B). 0: 3.3 V VCO operation. 1: 5 V VCO operation. | 0x1 | R/W |
| 3 | ALC_REF_DAC_LO_VCO3 | Sets ALC Threshold Voltage (Core B). 0: 5 V VCO operation. 1: 3.3 V VCO operation. | 0x0 | R/W |
| [2:0] | ALC_REF_DAC_NOM_VCO3 | Select VCO ALC Threshold (Core B). 010: 3.3 V and 5 V VCO operation. | 0x2 | R/W |

Address: 0x2F, Default: 0x94, Name: REG002F



Table 44. Bit Descriptions for REG002F

| Bit(s) | Bit Name | Description | Default | Access |
|--------|----------------------|--|---------|--------|
| 7 | SWITCH_LDO_3P3V_5V | Switch LDO Operation Between 3.3 V and 5 V. 0: 3.3 V VCO operation. 1: 5 V VCO operation. | 0x1 | R/W |
| [6:5] | RESERVED | Reserved. | 0x0 | R |
| 4 | ALC_RECT_SELECT_VCO4 | Sets ALC Rectifier DC Bias (Core A). 0: 3.3 V VCO operation. 1: 5 V VCO operation. | 0x1 | R/W |
| 3 | ALC_REF_DAC_LO_VCO4 | Select ALC Lower Threshold Voltage Range (Core A). 0: 5 V VCO operation. 1: 3.3 V VCO operation. | 0x0 | R/W |
| [2:0] | ALC_REF_DAC_NOM_VCO4 | Select VCO ALC Threshold (Core A). 010: 3.3 V VCO operation. 100: 5 V VCO operation. | 0x4 | R/W |

Address: 0x30, Default: 0x3F, Name: REG0030



Table 45. Bit Descriptions for REG0030

| Bit(s) | Bit Name | Description | Default | Access |
|--------|--------------|---|---------|--------|
| [7:0] | VCO_BAND_DIV | Sets the Autocalibration Time per Stage. See the Lock Time section for details. | 0x3F | R/W |

Address: 0x31, Default: 0xA7, Name: REG0031

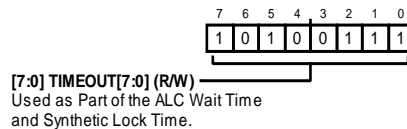

Table 46. Bit Descriptions for REG0031

| Bit(s) | Bit Name | Description | Default | Access |
|--------|--------------|---|---------|--------|
| [7:0] | TIMEOUT[7:0] | Used as Part of the ALC Wait Time and Synthetic Lock Time. See the Lock Time section for details. | 0xA7 | R/W |

Address: 0x32, Default: 0x04, Name: REG0032



Table 47. Bit Descriptions for REG0032

| Bit(s) | Bit Name | Description | Default | Access |
|--------|----------------|--|---------|--------|
| 7 | ADC_MUX_SEL | Analog-to-Digital Converter (ADC) Mux Select. 0: proportional to absolute temperature (PTAT) voltage muxed to ADC input. 1: scaled VTUNE voltage muxed to ADC input. | 0x0 | R/W |
| 6 | RESERVED | Reserved. | 0x0 | R |
| 5 | ADC_FAST_CONV | ADC Fast Conversion. 0: disabled. 1: enabled. | 0x0 | R/W |
| 4 | ADC_CTS_CONV | ADC Continuous Conversion. 0: disabled. 1: enabled. | 0x0 | R/W |
| 3 | ADC_CONVERSION | Enables ADC Conversion. 0: no ADC conversion. 1: perform ADC conversion on REG0000 write if ADC is enabled. | 0x0 | R/W |
| 2 | ADC_ENABLE | ADC Enable. 0: disabled. 1: enabled. | 0x1 | R/W |
| [1:0] | TIMEOUT[9:8] | Used as Part of the ALC Wait Time and Synthetic Lock Time. See the Lock Time section for details. | 0x0 | R/W |

Address: 0x33, Default: 0x0C, Name: REG0033



Table 48. Bit Descriptions for REG0033

| Bit(s) | Bit Name | Description | Default | Access |
|--------|--------------------|---|---------|--------|
| [7:5] | RESERVED | Reserved. | 0x0 | R |
| [4:0] | SYNTH_LOCK_TIMEOUT | Part of VCO Calibration Routine. See the Lock Time section for details. | 0xC | R/W |

Address: 0x34, Default: 0x9E, Name: REG0034

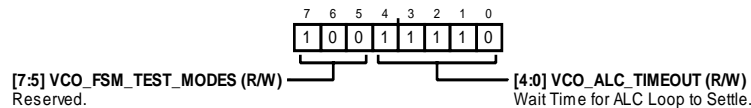

Table 49. Bit Descriptions for REG0034

| Bit(s) | Bit Name | Description | Default | Access |
|--------|--------------------|--|---------|--------|
| [7:5] | VCO_FSM_TEST_MODES | Reserved. | 0x4 | R/W |
| [4:0] | VCO_ALC_TIMEOUT | Wait Time for ALC Loop to Settle. See the Lock Time section for details. | 0x1E | R/W |

Address: 0x35, Default: 0x4C, Name: REG0035



Table 50. Bit Descriptions for REG0035

| Bit(s) | Bit Name | Description | Default | Access |
|--------|-----------------|--|---------|--------|
| [7:0] | ADC_CLK_DIVIDER | ADC Clock Divider. $ADC_CLK = f_{PFD} / ((ADC_CLK_DIV \times 4) + 2)$. | 0x4C | R/W |

Address: 0x36, Default: 0x30, Name: REG0036

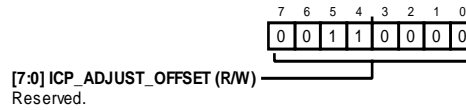

Table 51. Bit Descriptions for REG0036

| Bit(s) | Bit Name | Description | Default | Access |
|--------|-------------------|-------------|---------|--------|
| [7:0] | ICP_ADJUST_OFFSET | Reserved. | 0x30 | R/W |

Address: 0x37, Default: 0x00, Name: REG0037

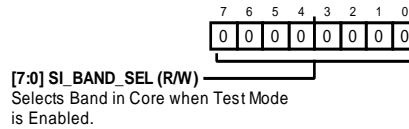

Table 52. Bit Descriptions for REG0037

| Bit(s) | Bit Name | Description | Default | Access |
|--------|-------------|---|---------|--------|
| [7:0] | SI_BAND_SEL | Selects Band in Core when Test Mode is Enabled. | 0x0 | R/W |

Address: 0x38, Default: 0x00, Name: REG0038



Table 53. Bit Descriptions for REG0038

| Bit(s) | Bit Name | Description | Default | Access |
|--------|------------------|--|---------|--------|
| [7:4] | SI_VCO_SEL | Selects Core when Test Mode is Enabled. 0: all cores off. 1: VCO Core D. 10: VCO Core C. 100: VCO Core B. 1000: VCO Core A. | 0x0 | R/W |
| [3:0] | SI_VCO_BIAS_CODE | Sets VCO Bias when Test Mode is Enabled. 0000: maximum VCO bias (approximately 3.2 V). 1111: minimum VCO bias (approximately 1.8 V). | 0x0 | R/W |

Address: 0x39, Default: 0x07, Name: REG0039



Table 54. Bit Descriptions for REG0039

| Bit(s) | Bit Name | Description | Default | Access |
|--------|----------------------|--|---------|--------|
| 7 | RESERVED | Reserved. | 0x0 | R |
| [6:4] | VCO_FSM_TEST_MUX_SEL | VCO Test Mux Select. 0: busy. 1: N band. 10: R band. 11: reserved. 100: timeout clock. 101: bias minimum. 110: ADC busy. 111: logic low. | 0x0 | R/W |
| [3:0] | SI_VTUNE_CAL_SET | Select VCO VTUNE Target Voltage when Test Mode is Enabled. 0: 58 V. 1: 0.73 V. 10: 0.88 V. 11: 1.03 V. 100: 1.18 V. 101: 1.33 V. 110: 1.48 V. 111: 1.63 V. 1000: 1.78 V. 1001: 1.93 V. 1010: 2.08 V. 1011: 2.23 V. 1100: 2.38 V. 1101: 2.53 V. 1110: 2.68 V. 1111: 2.83 V. | 0x7 | R/W |

Address: 0x3A, Default: 0x55, Name: REG003A



Table 55. Bit Descriptions for REG003A

| Bit(s) | Bit Name | Description | Default | Access |
|--------|------------|--|---------|--------|
| [7:0] | ADC_OFFSET | VCO Calibration ADC Offset Correction. | 0x55 | R/W |

Address: 0x3D, Default: 0x00, Name: REG003D

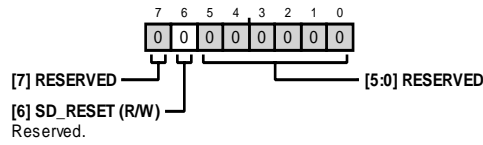

Table 56. Bit Descriptions for REG003D

| Bit(s) | Bit Name | Description | Default | Access |
|--------|----------|-------------|---------|--------|
| 7 | RESERVED | Reserved. | 0x0 | R |
| 6 | SD_RESET | Reserved. | 0x0 | R/W |
| [5:0] | RESERVED | Reserved. | 0x0 | R |

Address: 0x3E, Default: 0x0C, Name: REG003E

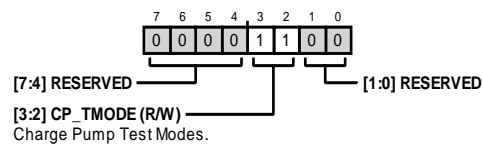

Table 57. Bit Descriptions for REG003E

| Bit(s) | Bit Name | Description | Default | Access |
|--------|----------|---|---------|--------|
| [7:4] | RESERVED | Reserved. | 0x0 | R |
| [3:2] | CP_TMODE | Charge Pump (CP) Test Modes 0: CP tristate 11: normal operation | 0x3 | R/W |
| [1:0] | RESERVED | Reserved. | 0x0 | R |

Address: 0x3F, Default: 0x80, Name: REG003F



Table 58. Bit Descriptions for REG003F

| Bit(s) | Bit Name | Description | Default | Access |
|--------|---------------|-------------|---------|--------|
| [7:0] | CLK1_DIV[7:0] | Reserved. | 0x80 | R/W |

Address: 0x40, Default: 0x50, Name: REG0040

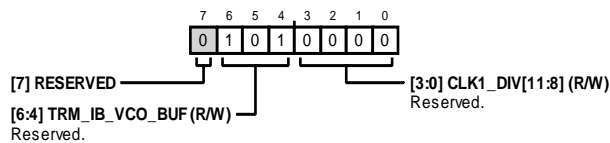

Table 59. Bit Descriptions for REG0040

| Bit(s) | Bit Name | Description | Default | Access |
|--------|----------------|-------------|---------|--------|
| 7 | RESERVED | Reserved. | 0x0 | R |
| [6:4] | TRM_IB_VCO_BUF | Reserved. | 0x5 | R/W |
| [3:0] | CLK1_DIV[11:8] | Reserved. | 0x0 | R/W |

Address: 0x41, Default: 0x28, Name: REG0041



Table 60. Bit Descriptions for REG0041

| Bit(s) | Bit Name | Description | Default | Access |
|--------|---------------------|-------------|---------|--------|
| [7:0] | CLK2_DIVIDER_1[7:0] | Reserved. | 0x28 | R/W |

Address: 0x42, Default: 0x00, Name: REG0042



Table 61. Bit Descriptions for REG0042

| Bit(s) | Bit Name | Description | Default | Access |
|--------|----------------------|-------------|---------|--------|
| [7:4] | CLK2_DIVIDER_2 | Reserved. | 0x0 | R/W |
| [3:0] | CLK2_DIVIDER_1[11:8] | Reserved. | 0x0 | R/W |

Address: 0x47, Default: 0xC0, Name: REG0047

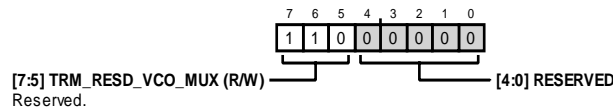

Table 62. Bit Descriptions for REG0047

| Bit(s) | Bit Name | Description | Default | Access |
|--------|-------------------|-------------|---------|--------|
| [7:5] | TRM_RES_D_VCO_MUX | Reserved. | 0x6 | R/W |
| [4:0] | RESERVED | Reserved. | 0x0 | R |

Address: 0x52, Default: 0xF4, Name: REG0052



Table 63. Bit Descriptions for REG0052

| Bit(s) | Bit Name | Description | Default | Access |
|--------|--------------------|----------------------------|---------|--------|
| [7:5] | TRM_RES_D_VCO_BUF | Reserved. VCO buffer trim. | 0x7 | R/W |
| [4:2] | TRM_RESC_I_VCO_BUF | Reserved. | 0x5 | R/W |
| [1:0] | RESERVED | Reserved. | 0x0 | R |

Address: 0x6E, Default: 0x00, Name: REG006E

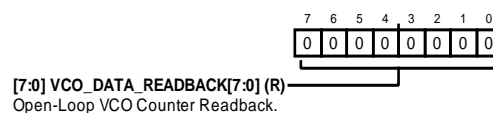

Table 64. Bit Descriptions for REG006E

| Bit(s) | Bit Name | Description | Default | Access |
|--------|------------------------|---------------------------------|---------|--------|
| [7:0] | VCO_DATA_READBACK[7:0] | Open-Loop VCO Counter Readback. | 0x0 | R |

Address: 0x6F, Default: 0x00, Name: REG006F



Table 65. Bit Descriptions for REG006F

| Bit(s) | Bit Name | Description | Default | Access |
|--------|-------------------------|---------------------------------|---------|--------|
| [7:0] | VCO_DATA_READBACK[15:8] | Open-Loop VCO Counter Readback. | 0x0 | R |

Address: 0x70, Default: 0x03, Name: REG0070



Table 66. Bit Descriptions for REG0070

| Bit(s) | Bit Name | Description | Default | Access |
|--------|-------------|--|---------|--------|
| [7:5] | BAND_SEL_X2 | Filter select for Doubler Output Tacking Filter. | 0x0 | R/W |
| [4:2] | RESERVED | Reserved. | 0x0 | R |
| [1:0] | BIAS_SEL_X2 | Bias select for Doubler Output Tacking Bias. | 0x3 | R/W |

Address: 0x71, Default: 0x60, Name: REG0071



Table 67. Bit Descriptions for REG0071

| Bit(s) | Bit Name | Description | Default | Access |
|--------|-------------|---|---------|--------|
| [7:5] | BAND_SEL_X4 | Filter select for Quadrupler Output Tacking Filter. | 0x3 | R/W |
| [4:2] | RESERVED | Reserved. | 0x0 | R |
| [1:0] | BIAS_SEL_X4 | Bias select for Quadrupler Output Tacking Bias. | 0x0 | R/W |

Address: 0x72, Default: 0x32, Name: REG0072



Table 68. Bit Descriptions for REG0072

| Bit(s) | Bit Name | Description | Default | Access |
|--------|--------------|--|---------|--------|
| 7 | RESERVED | Reserved. | 0x0 | R |
| 6 | AUX_FREQ_SEL | Auxiliary RF Output Frequency Select. 0: divided output. 1: VCO output. | 0x0 | R/W |
| [5:4] | POUT_AUX | Auxiliary RF Output Power. Sets the output power at the auxiliary RF output ports. 0: -4.5 dBm single-ended ÷ -1.5 dBm differential. 1: 1 dBm single-ended ÷ 4 dBm differential. 10: 4 dBm single-ended ÷ 7 dBm differential. 11: 6 dBm single-ended ÷ 9 dBm differential. | 0x3 | R/W |
| 3 | PDB_AUX | Power-Down Auxiliary RF Output. 0: auxiliary RF off. 1: auxiliary RF on. | 0x0 | R/W |
| 2 | RESERVED | Reserved. | 0x0 | R |
| 1 | COUPLED_VCO | Reserved. | 0x1 | R/W |
| 0 | RESERVED | Reserved. | 0x0 | R |

Address: 0x73, Default: 0x00, Name: REG0073



Table 69. Bit Descriptions for REG0073

| Bits | Bit Name | Description | Default | Access |
|-------|-----------------|---|---------|--------|
| [7:3] | RESERVED | Reserved. | 0x0 | R |
| 2 | ADC_CLK_DISABLE | Disable ADC Clock. ADC_ENABLE setting overwrites this bit. | 0x0 | R/W |
| 1 | PD_NDIV | Power-Down N Divider. | 0x0 | R/W |
| 0 | LD_DIV | Lock Detector Count Divider. Divides the lock detector count cycles by 32 so that the LD_COUNT bits in REG0028 can be selected as 32, 64, 128, and 256. | 0x0 | R/W |

Address: 0x7C, Default: 0x00, Name: REG007C

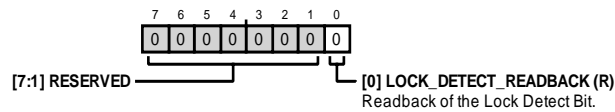

Table 70. Bit Descriptions for REG007C

| Bit(s) | Bit Name | Description | Default | Access |
|--------|----------------------|----------------------------------|---------|--------|
| [7:1] | RESERVED | Reserved. | 0x0 | R |
| 0 | LOCK_DETECT_READBACK | Readback of the Lock Detect Bit. | 0x0 | R |

OUTLINE DIMENSIONS

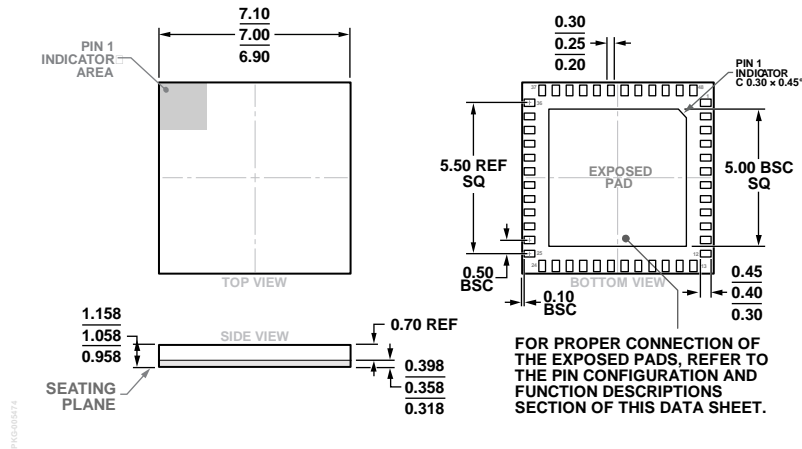

Figure 45. 48-Terminal Land Grid Array Package (LGA)
(CC-48-4)
Dimensions shown in millimeters

ORDERING GUIDE

| Model ¹ | Temperature Range | Package Description | Package Option |
|--------------------|-------------------|---|----------------|
| ADF4371BCCZ | -40°C to +105°C | 48-Terminal Land Grid Array Package [LGA] | CC-48-4 |
| ADF4371BCCZ-RL7 | -40°C to +105°C | 48-Terminal Land Grid Array Package [LGA] | CC-48-4 |
| EV-ADF4371SD2Z | | Evaluation Board | |

¹ Z = RoHS Compliant Part.