

A

B

C

D

E

F

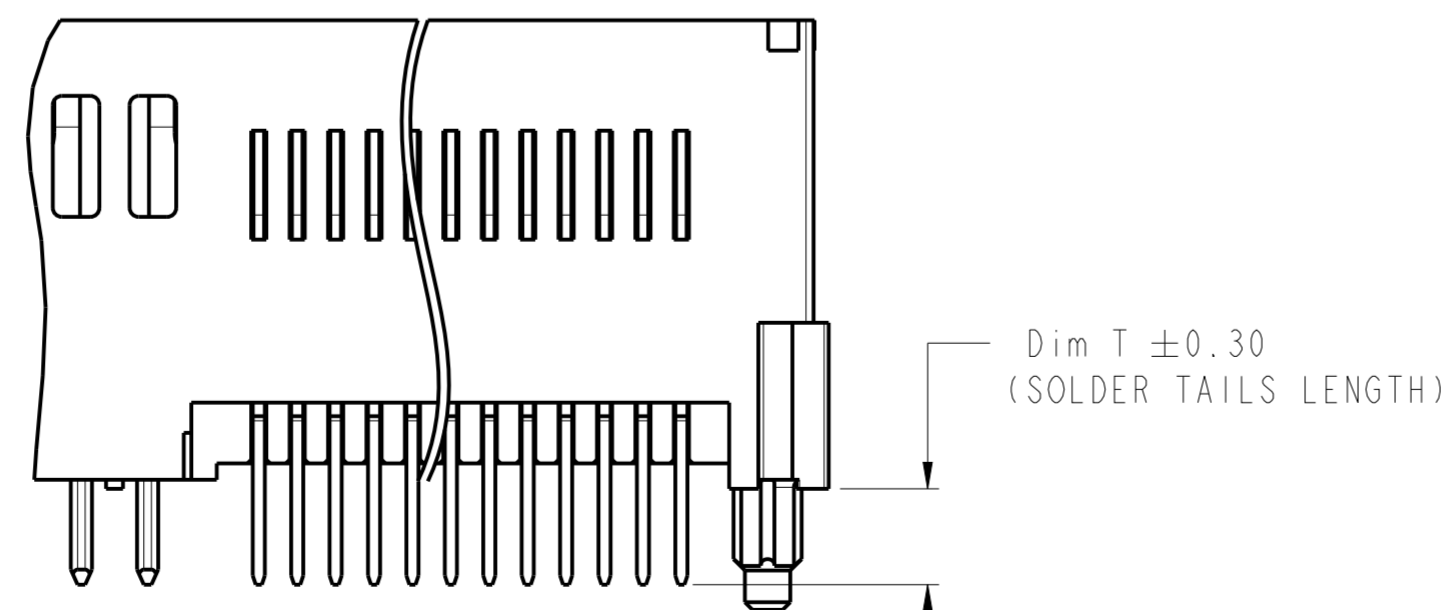
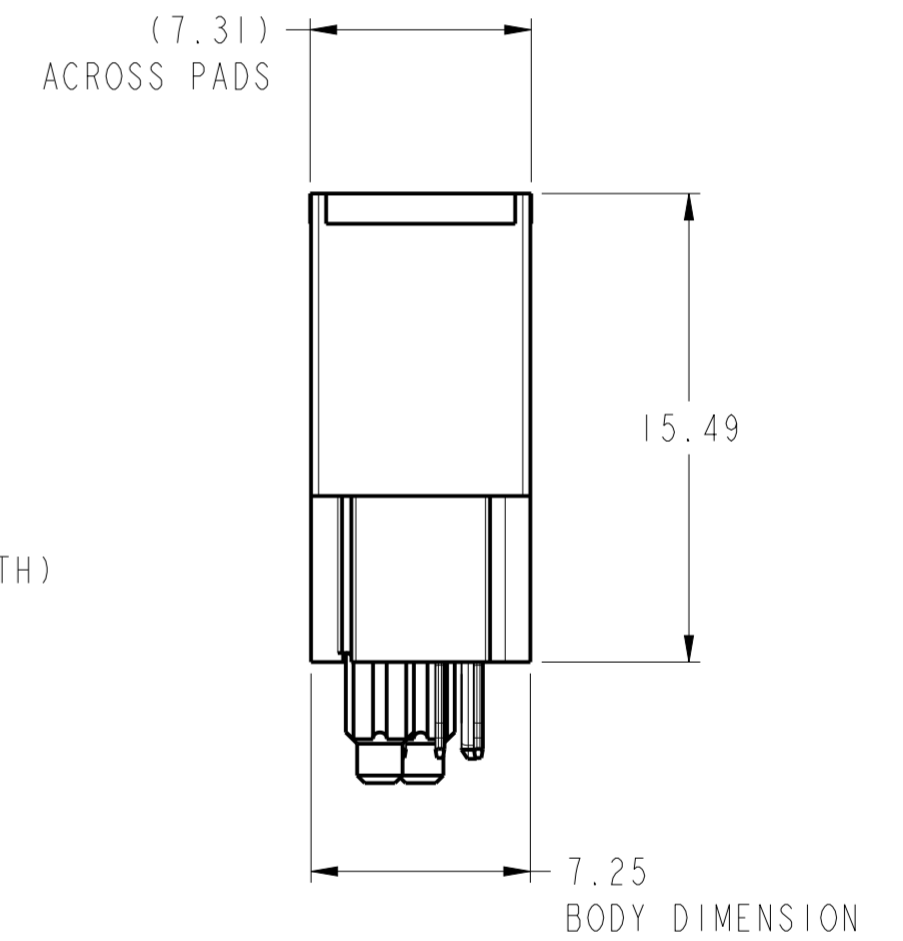
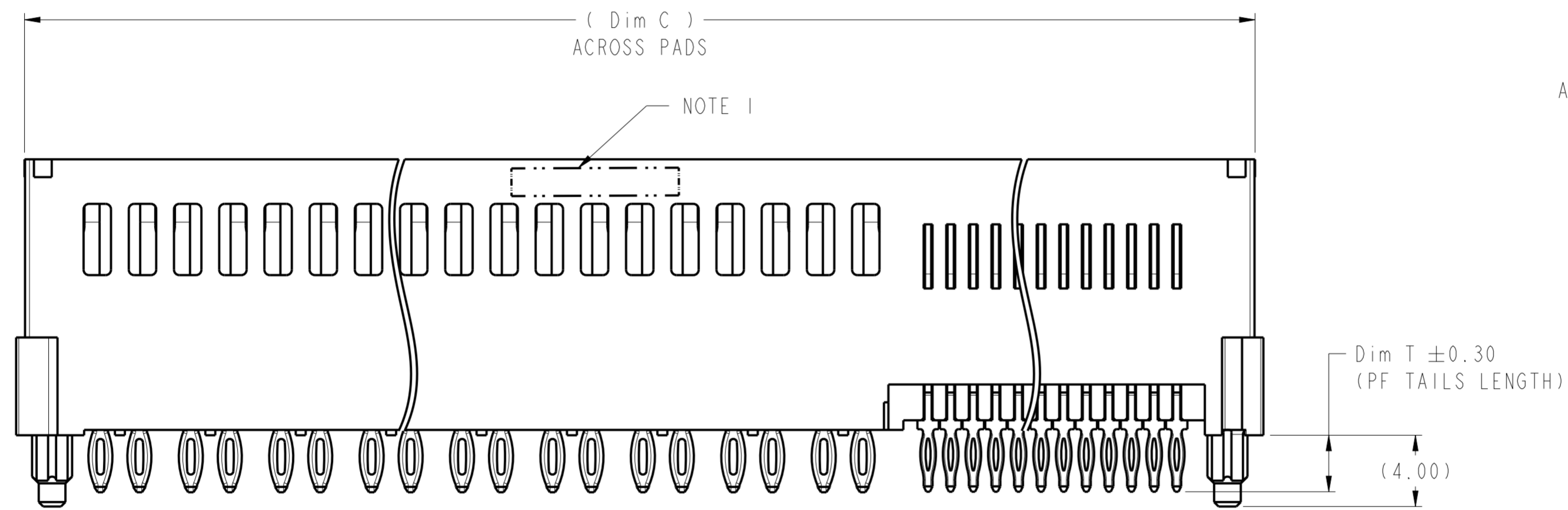
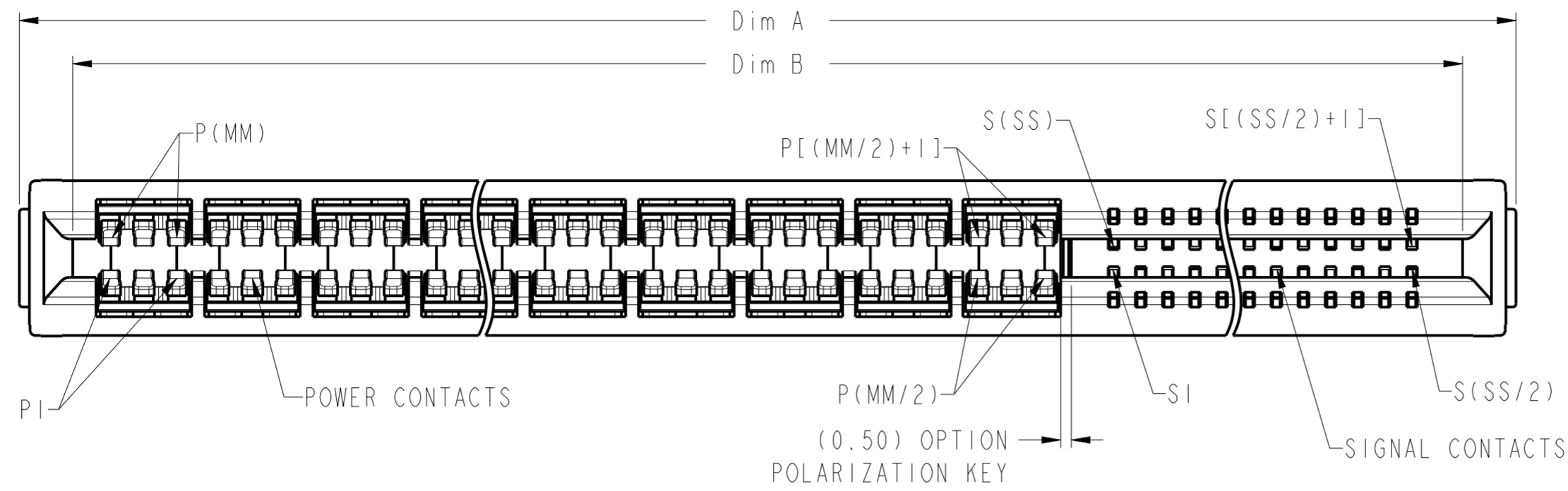

spec ref	-	dr	Andy Lu	2017-10-24	projection	MM	size	A2	scale	5:1
tolerance std	ISO 406 ISO 1101	eng	Andy Lu	2017-10-24			ecn no	rel level	In Work	rev
TOLERANCES UNLESS OTHERWISE SPECIFIED		chr	Fancy Zhong	2017-10-24						
surface	linear	0.X	±0.5		eHPCE VERTICAL RECEPTACLE UNIVERSAL DRAWING, MP+S CONFIGURATION		cat. no.	Product - Customer Drw	sheet 1 of 4	
		0.XX	±0.25							
	angular	0°	±2°							

Amphenol
FCi

© 2016 AFCI

CONTACT TYPE	TOP LAYER DESCRIPTION	TABLE 1 (eHPCE / PRESS-FIT TAILS) PLATED THROUGH-HOLE REQUIREMENTS				
		DRILLED HOLE DIAMETER	COPPER THICKNESS	TIN-LEAD THICKNESS	TIN THICKNESS	FINISHED HOLE DIAMETER
SIGNAL	IMMERSION TIN	0.81-0.86 (0.85 DRILL)	0.025 - 0.050	--	0.9 - 1.5um	0.70 - 0.80
	COPPER	0.81-0.86 (0.85 DRILL)	0.025 - 0.050	--	--	0.70 - 0.80
POWER	IMMERSION TIN	1.21-1.26 (1.25 DRILL)	0.025 - 0.050	--	0.9 - 1.5um	1.10 - 1.20
	COPPER	1.21-1.26 (1.25 DRILL)	0.025 - 0.050	--	--	1.10 - 1.20

CONTACT TYPE	TOP LAYER DESCRIPTION	TABLE 2 (eHPCE / SOLDER TAILS) PLATED THROUGH-HOLE REQUIREMENTS				
		DRILLED HOLE DIAMETER	COPPER THICKNESS	TIN-LEAD THICKNESS	TIN THICKNESS	FINISHED HOLE DIAMETER
SIGNAL	IMMERSION TIN	0.96-1.01 (1.00 DRILL)	0.025 - 0.050	--	0.9 - 1.5um	0.85 - 0.95
	COPPER	0.96-1.01 (1.00 DRILL)	0.025 - 0.050	--	--	0.85 - 0.95
POWER	IMMERSION TIN	1.21-1.26 (1.25 DRILL)	0.025 - 0.050	--	0.9 - 1.5um	1.10 - 1.20
	COPPER	1.21-1.26 (1.25 DRILL)	0.025 - 0.050	--	--	1.10 - 1.20



RECOMMENDED HOST BOARD LAYOUT
(DIMENSION TOLERANCE IS ±0.05mm)

spec ref	-	dr	Andy Lu	2017-10-24	projection	MM	size	A2	scale	5:1
tolerance std	ISO 406 ISO 1101	eng	Andy Lu	2017-10-24			ecn no			
TOLERANCES UNLESS OTHERWISE SPECIFIED		chr	Fancy Zhong	2017-10-24			rel level	In Work		
surface	linear	0.X	±0.5	appr	Pei-Ming Zhong	2017-10-24	product family			
		0.XX	±0.25	Amphenol FCI		eHPCE VERTICAL RECEPTACLE	cat. no.	10140903	rev	7
		0.XXX	±0.10	UNIVERSAL DRAWING, MP+S CONFIGURATION			Product - Customer Drw	sheet 2 of 4		
	angular	0°	±2°							

Amphenol FCI

© 2016 APCI

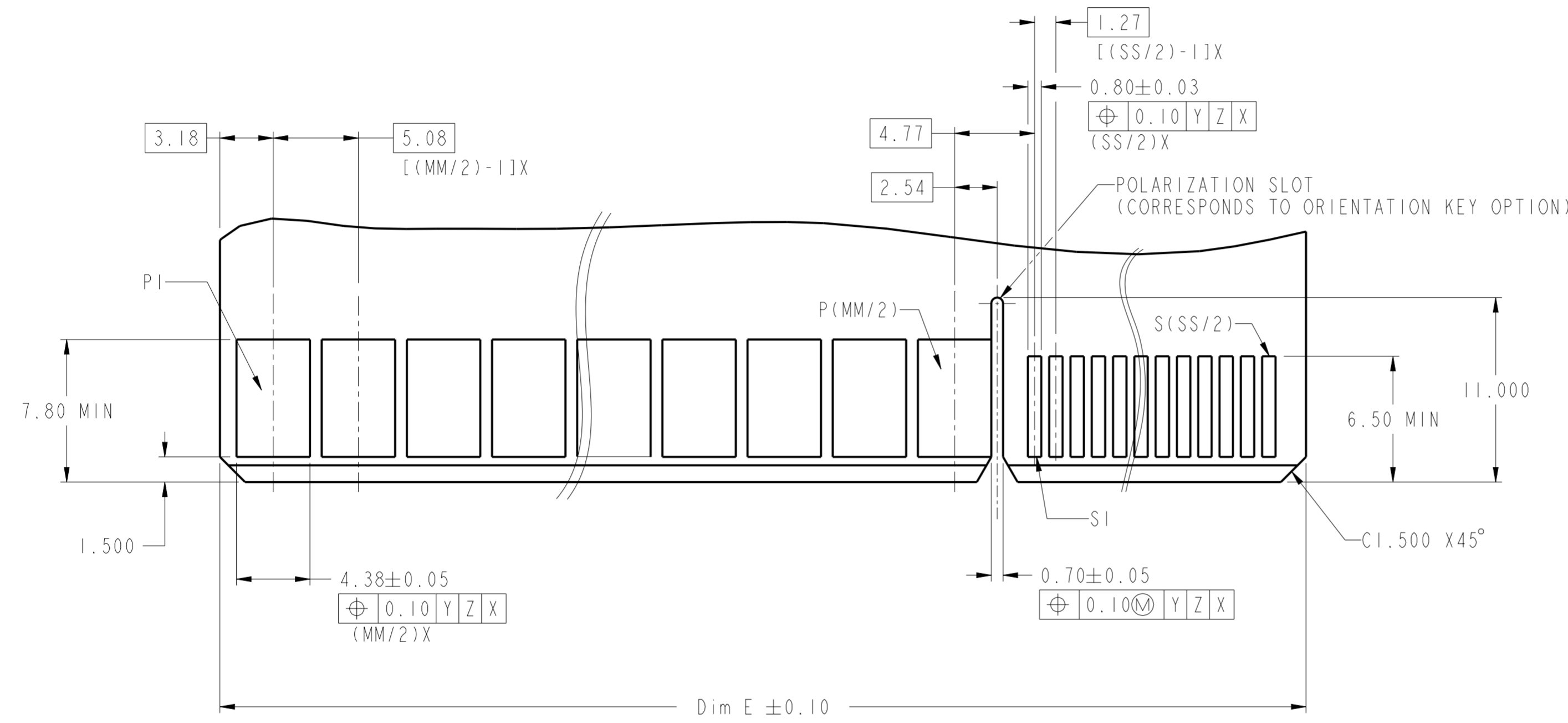

RECOMMENDED MATING BOARD LAYOUT
(DIMENSION TOLERANCE IS ±0.05mm)



DETAIL B
SCALE 10:1

spec ref	-	dr	Andy Lu	2017-10-24	projection	MM	size	A2	scale	4:1
tolerance std	ISO 406 ISO 1101	eng	Andy Lu	2017-10-24			ecn no	rel level	In Work	rev
TOLERANCES UNLESS OTHERWISE SPECIFIED		chr	Fancy Zhong	2017-10-24						
surface	ISO 1302	appr	Pei-Ming Zhong	2017-10-24	product family		cat. no.	10140903	7	
	linear	0.X	±0.5		Amphenol FCI eHPCE VERTICAL RECEPTACLE		Product - Customer Drw		sheet 3 of 4	
		0.XX	±0.25		UNIVERSAL DRAWING, MP+S CONFIGURATION					
	angular	0°	±2°							

Amphenol FCI

© 2016 APCI

10140903 - MM SS * LF

LEAD FREE
BLANK: BLACK
2: BLUE

	A	B	C	D	E	F
POLARIZATION KEY OPTION	Y	N	Y	N	Y	N
TAIL LENGTH(Dim T)	3.17	3.17	3.17	3.17	2.40	2.40
TAIL TYPE/ HOST PCB THICKNESS	PF/ 1.57Min.	PF/ 1.57Min	STB/ 2.36±0.13	STB/ 2.36±0.13	STB/ 1.57±0.13	STB/ 1.57±0.13

DIM	LENGTH FORMULAS
DIM A	(MM/2)X5.08 + (SS/2)X1.27 + 9.12
DIM B	DIM "A" - 5.00
DIM C	DIM "A" - 0.94
DIM D	DIM "A" - 4.04
DIM E	DIM "A" - 5.30

MIDDLE POWER CONTACTS QTY(36MP Max.) SIGNAL CONTACTS QTY(36S Max.)

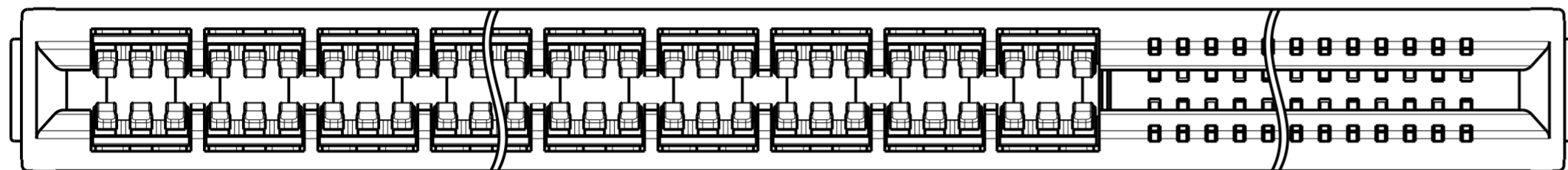

G	H
Y	N
3.75	3.75
STB/ 3.00±0.13	STB/ 3.00±0.13

EXAMPLE: THE CONFIGURATION ABOVE IS 10140903-1824A2LF
eHPCE VERTICAL RECEPTACLE PF TYPE WITH 18MP24S AND POLARIZATION KEY;
18MP MEANS 18PCS MIDDLE POWER CONTACTS, 24S MEANS 24PCS SIGNAL CONTACTS.

TABLE 3. PART NUMBER CODE. eHPCE VERTICAL MP+S CONFIG

NOTES:

- 1) PRODUCT MARK:
PART NUMBER AND DATE CODE TO BE MARKED ON THIS SURFACE.
THE MARK CAN BE OMITTED IF THERE IS NOT ENOUGH SPACE ON THIS SURFACE.
- 2) MATERIALS:
-HOUSING : HIGH TEMP THERMOPLASTIC WITH GLASS FIBER, UL94V-0, BLUE
-POWER CONTACT : HIGH CONDUCTIVITY COPPER ALLOY.
-SIGNAL CONTACT : COPPER ALLOY
- 3) PLATING SPECIFICATION:
-POWER CONTACT:
CONTACT AREA: GCS OVER NI+LUBRICANT, LUBRICANT APPLICATION AT THE END OF THE PLATING LINE
SOLDER TAIL AREA: MATTE SN OVER NI
-SIGNAL CONTACT:
CONTACT AREA:GXT OVER NI
SOLDER TAIL AREA: MATTE SN OVER NI
- 4) DENOTES CONNECTOR KEEP OUT ZONE.
- 5) DATUM AND BASIC DIMENSIONS WERE ESTABLISHED BY CUSTOMER.
- 6) ALL HOLE DIAMETERS ARE FINISHED HOLE SIZES.
- 7) THE PRODUCT OF PF TYPE IS NOT INTENDED TO BE EXPOSED TO A MANUFACTURING SOLDER PROCESS.
THE HOUSING OF STB TYPE WILL WITHSTAND EXPOSURE TO 245 °C PEAK TEMPERATURE FOR 10 SECONDS
IN A WAVE SOLDER APPLICATION.
- 8) THIS PRODUCT MEETS EUROPEAN UNION DIRECTIVES AND OTHER COUNTRY REGULATIONS AS DESCRIBED IN GS-47-0004.
- 9) PRODUCT SPECIFICATION : GS-12-1380.
APPLICATION SPECIFICATION : GS-20-0488, APPLICATION TOOLING FOR PF TYPE,SEE DRAWING 10141462.
PRODUCT PACKAGE SPECIFICATION: GS-14-2532.
- 10) MOUNTING HOLES ARE UNPLATED
∅ 2.40+/-0.05 FOR PRESS FIT(PF) TAILS.
∅ 2.18+/-0.03 FOR SOLDER TO BOARD(STB) TAILS.
- 11) MAXIMUM OVERALL LENGTH IS 100mm.

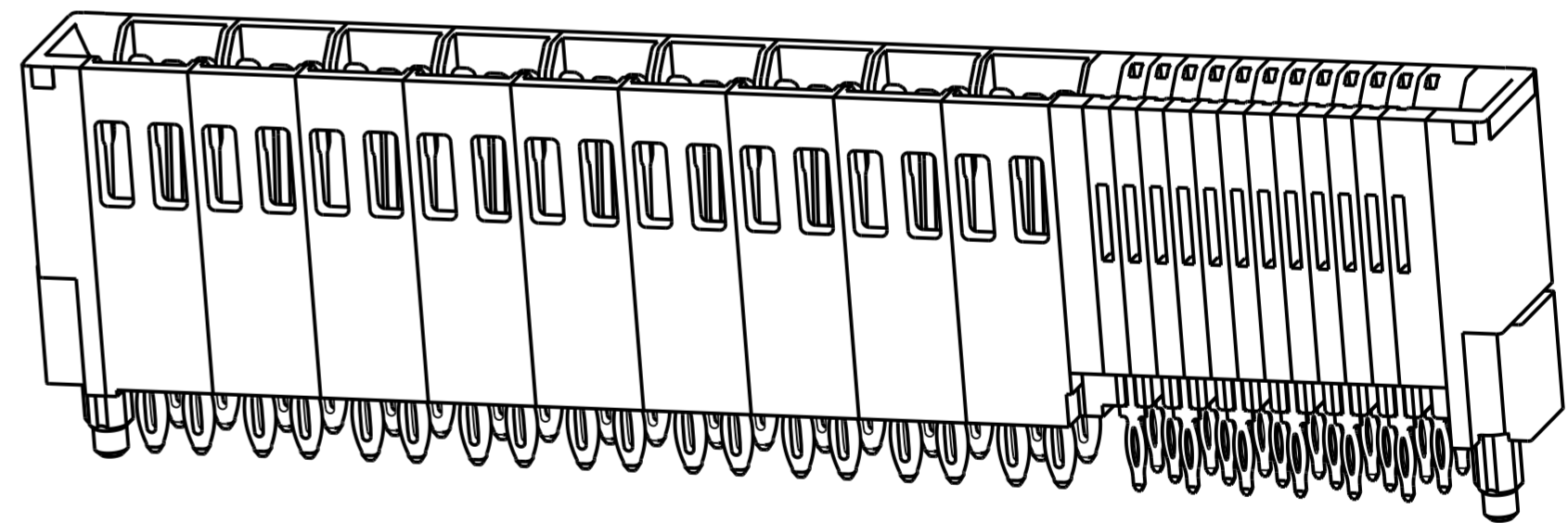

EXAMPLE: 10140903-1824A2LF

spec ref	-	dr	Andy Lu	2017-10-24	projection	MM	size	A2	scale	2:1
tolerance std	ISO 406 ISO 1101	eng	Andy Lu	2017-10-24			ecn no	rel level	In Work	rev
TOLERANCES UNLESS OTHERWISE SPECIFIED		chr	Fancy Zhong	2017-10-24						
surface	linear 0.X ±0.5 0.XX ±0.25 0.XXX ±0.10 angular 0° ±2°	appr	Pei-Ming Zhong	2017-10-24	Amphenol FCI eHPCE VERTICAL RECEPTACLE UNIVERSAL DRAWING,MP+S CONFIGURATION		cat. no.	Product - Customer Drw	sheet 4 of 4	

Amphenol FCI

© 2016 AFCI