



# ±15kV ESD-Protected, Low-Voltage, Quad, SPST, CMOS Analog Switches

## General Description

The MAX4620/MAX4630/MAX4640 low-voltage, high-ESD-protected, quad, single-pole/single-throw (SPST) analog switches are pin-compatible replacements for the industry-standard 74HC4066 analog switch. The normally open (NO) and normally closed (NC) pins are protected against ±15kV electrostatic discharge (ESD) without latchup or damage. Each switch can handle Rail-to-Rail® analog signals. The off-leakage current is 0.5nA at +25°C. These analog switches are suitable for low-distortion audio applications and are the preferred solution over mechanical relays in automated test equipment or applications where current switching is required. They have low power requirements (0.5μW), require less board space, and are more reliable than mechanical relays. Each device is controlled by TTL/CMOS input voltage levels and is bilateral.

These switches feature guaranteed operation from a +2V to +12V single supply, making them ideal for use in battery-powered applications. The on-resistance is 70Ω max, matched between switches to 0.5Ω (typ), and flat (2Ω typ) over the specified signal range.

The MAX4620 has four NO switches, the MAX4630 has four NC switches, and the MAX4640 has two NO and two NC switches. These devices are available in 14-pin TSSOP, SO, and DIP packages.

## Applications

Battery-Powered Systems  
 Audio and Video Signal Routing  
 Low-Voltage Data-Acquisition Systems  
 Sample-and-Hold Circuits  
 Communications Circuits  
 Relay Replacement

## Ordering Information

PART	TEMP. RANGE	PIN-PACKAGE
MAX4620EUD	-40°C to +85°C	14 TSSOP
MAX4620ESD	-40°C to +85°C	14 SO
MAX4620EPD	-40°C to +85°C	14 DIP
MAX4630EUD	-40°C to +85°C	14 TSSOP
MAX4630ESD	-40°C to +85°C	14 SO
MAX4630EPD	-40°C to +85°C	14 DIP

Ordering information continued at end of data sheet.

Rail-to-Rail is a registered trademark of Nippon Motorola, Ltd.



Maxim Integrated Products 1

For free samples and the latest literature, visit [www.maxim-ic.com](http://www.maxim-ic.com) or phone 1-800-998-8800.  
 For small orders, phone 1-800-835-8769.

## Features

- ◆ ESD-Protected NO/NC Pins
  - ±15kV Human Body Model
  - ±15kV IEC 1000-4-2 Air-Gap Discharge
  - ±8kV IEC 1000-4-2 Contact Discharge
- ◆ Pin Compatible with Industry-Standard 74HC4066, MAX4066, MAX4610/MAX4611/MAX4612
- ◆ Guaranteed On-Resistance
  - 70Ω (max) at 5V
  - 120Ω (max) at 3V
- ◆ On-Resistance Flatness
  - 2Ω (typ) at 5V
  - 6Ω (typ) at 3V
- ◆ On-Resistance Matching
  - 0.5Ω (typ) at 5V
  - 0.6Ω (typ) at 3V
- ◆ Guaranteed 0.5nA Leakage Current at T<sub>A</sub> = +25°C
- ◆ +2V to +12V Single-Supply Voltage
- ◆ TTL/CMOS-Logic Compatible
- ◆ Low Distortion: 0.015%
- ◆ -3dB Bandwidth: >300MHz
- ◆ Rail-to-Rail Signal Range

## Pin Configurations/Functional Diagrams/Truth Tables



MAX4620/MAX4630/MAX4640

# ±15kV ESD-Protected, Low-Voltage, Quad, SPST, CMOS Analog Switches

## ABSOLUTE MAXIMUM RATINGS

V+ to GND	-0.3V to +13V
IN <sub>-</sub> , COM <sub>-</sub> , NO <sub>-</sub> , NC <sub>-</sub> to GND (Note 1)	-0.3V to (V+ + 0.3V)
Continuous Current (NO <sub>-</sub> , NC <sub>-</sub> , COM <sub>-</sub> )	±10mA
Peak Current (NO <sub>-</sub> , NC <sub>-</sub> , COM <sub>-</sub> , pulsed at 1ms 10% duty cycle)	±30mA
ESD Protection per Method IEC 1000-4-2 (NO <sub>-</sub> , NC <sub>-</sub> )	
Air-Gap Discharge	±15kV
Contact Discharge	±8kV
ESD Protection per Method 3015.7	
V+, GND, IN <sub>-</sub> , COM <sub>-</sub>	±2.5kV
NO <sub>-</sub> , NC <sub>-</sub>	±15kV

Continuous Power Dissipation (T <sub>A</sub> = +70°C)	
14-Pin TSSOP (derate 6.3mW/°C above +70°C)	571mW
14-Pin DIP (derate 10mW/°C above +70°C)	800mW
14-Pin SO (derate 8mW/°C above +70°C)	640mW
Operating Temperature Ranges	
MAX46_E	-40°C to +85°C
Storage Temperature Range	-65°C to +150°C
Maximum Die Temperature	+150°C
Lead Temperature (soldering, 10s)	+300°C

**Note 1:** Signals on NO<sub>-</sub>, NC<sub>-</sub>, COM<sub>-</sub>, or IN<sub>-</sub> exceeding V+ or GND are clamped by internal diodes. Limit forward current to maximum current rating.

Stresses beyond those listed under "Absolute Maximum Ratings" may cause permanent damage to the device. These are stress ratings only, and functional operation of the device at these or any other conditions beyond those indicated in the operational sections of the specifications is not implied. Exposure to absolute maximum rating conditions for extended periods may affect device reliability.

## ELECTRICAL CHARACTERISTICS—SINGLE +5V SUPPLY

(V+ = +4.5V to +5.5V, V<sub>IH</sub> = 2.4V, V<sub>IL</sub> = 0.8V, T<sub>A</sub> = T<sub>MIN</sub> to T<sub>MAX</sub>, unless otherwise specified. Typical values are at V+ = +5V, T<sub>A</sub> = +25°C.) (Note 2)

PARAMETER	SYMBOL	CONDITIONS	MIN	TYP	MAX	UNITS	
<b>ANALOG SWITCH</b>							
Input Voltage Range	V <sub>COM-</sub> , V <sub>NO-</sub> , V <sub>NC-</sub>		0		V+	V	
On-Resistance	R <sub>ON</sub>	V+ = 4.5V, I <sub>COM-</sub> = 1mA, V <sub>NO-</sub> or V <sub>NC-</sub> = 3.5V	T <sub>A</sub> = +25°C	45	70	Ω	
			T <sub>A</sub> = T <sub>MIN</sub> to T <sub>MAX</sub>		75		
On-Resistance Match Between Channels (Note 3)	ΔR <sub>ON</sub>	V+ = 4.5V, I <sub>COM-</sub> = 1mA, V <sub>NO-</sub> or V <sub>NC-</sub> = 3.5V	T <sub>A</sub> = +25°C	0.5	2	Ω	
			T <sub>A</sub> = T <sub>MIN</sub> to T <sub>MAX</sub>		3		
On-Resistance Flatness (Note 4)	R <sub>FLAT(ON)</sub>	V+ = 4.5V; I <sub>COM-</sub> = 1mA; V <sub>NO-</sub> or V <sub>NC-</sub> = 1V, 2.25V, 3.5V	T <sub>A</sub> = +25°C	2	4	Ω	
			T <sub>A</sub> = T <sub>MIN</sub> to T <sub>MAX</sub>		5		
Off-Leakage Current (NO <sub>-</sub> or NC <sub>-</sub> ) (Note 5)	I <sub>NO-</sub> , I <sub>NC-</sub>	V+ = 5.5V; V <sub>COM-</sub> = 1V, 4.5V; V <sub>NO-</sub> or V <sub>NC-</sub> = 4.5V, 1V	T <sub>A</sub> = +25°C	-0.5	0.01	0.5	nA
			T <sub>A</sub> = T <sub>MIN</sub> to T <sub>MAX</sub>	-5		5	

# ±15kV ESD-Protected, Low-Voltage, Quad, SPST, CMOS Analog Switches

## ELECTRICAL CHARACTERISTICS—SINGLE +5V SUPPLY (continued)

(V<sub>+</sub> = +4.5V to +5.5V, V<sub>IH</sub> = 2.4V, V<sub>IL</sub> = 0.8V, T<sub>A</sub> = T<sub>MIN</sub> to T<sub>MAX</sub>, unless otherwise specified. Typical values are at V<sub>+</sub> = +5V, T<sub>A</sub> = +25°C.) (Note 2)

PARAMETER	SYMBOL	CONDITIONS	MIN	TYP	MAX	UNITS	
<b>ANALOG SWITCH</b>							
COM_ Off-Leakage Current (Note 5)	I <sub>COM(OFF)</sub>	V <sub>+</sub> = 5.5V; V <sub>COM_</sub> = 1V, 4.5V; V <sub>NO_</sub> or V <sub>NC_</sub> = 4.5V, 1V	T <sub>A</sub> = +25°C	-0.5	0.01	0.5	nA
			T <sub>A</sub> = T <sub>MIN</sub> to T <sub>MAX</sub>	-5		5	
COM_ On-Leakage Current (Note 5)	I <sub>COM(ON)</sub>	V <sub>+</sub> = 5.5V; V <sub>COM_</sub> = 1V, 4.5V; V <sub>NO_</sub> or V <sub>NC_</sub> = 1V, 4.5V, or floating	T <sub>A</sub> = +25°C	-1	0.02	1	nA
			T <sub>A</sub> = T <sub>MIN</sub> to T <sub>MAX</sub>	-10		10	
<b>LOGIC INPUT</b>							
IN_ Input High	V <sub>IH</sub>		2.4			V	
IN_ Input Low	V <sub>IL</sub>				0.8	V	
Logic Input Leakage Current	I <sub>IN</sub>	V <sub>IN</sub> = 0 or V <sub>+</sub>	-1		1	μA	
<b>SWITCH DYNAMIC CHARACTERISTICS</b>							
Turn-On Time	t <sub>ON</sub>	V <sub>COM_</sub> = 3V, R <sub>L</sub> = 300Ω, C <sub>L</sub> = 35pF, Figure 1	T <sub>A</sub> = +25°C	90	150	ns	
			T <sub>A</sub> = T <sub>MIN</sub> to T <sub>MAX</sub>		180		
Turn-Off Time	t <sub>OFF</sub>	V <sub>COM_</sub> = 3V, C <sub>L</sub> = 35pF, R <sub>L</sub> = 300Ω, Figure 1	T <sub>A</sub> = +25°C	50	80	ns	
			T <sub>A</sub> = T <sub>MIN</sub> to T <sub>MAX</sub>		100		
Break-Before-Make (MAX4640 only)		V <sub>COM_</sub> = 3V, R <sub>L</sub> = 300Ω, C <sub>L</sub> = 35pF	T <sub>A</sub> = +25°C	5	45	ns	
			T <sub>A</sub> = T <sub>MIN</sub> to T <sub>MAX</sub>	4			
On-Channel Bandwidth -3dB	BW	Signal = 0dBm, R <sub>IN</sub> = R <sub>OUT</sub> = 50Ω, C <sub>L</sub> = 5pF, Figure 2		300		MHz	
Charge Injection	Q	V <sub>GEN</sub> = 2V, C <sub>L</sub> = 1.0nF, R <sub>GEN</sub> = 0, Figure 4		5		pC	
NO_ or NC_ On-Capacitance	C <sub>OFF</sub>	V <sub>NO_</sub> = V <sub>NC_</sub> = GND, f = 1MHz, Figure 3		20		pF	
COM_ Off-Capacitance	C <sub>COM(OFF)</sub>	V <sub>COM_</sub> = GND, f = 1MHz, Figure 3		12		pF	
COM_ On-Capacitance	C <sub>COM(ON)</sub>	V <sub>COM_</sub> = V <sub>NO_</sub> , V <sub>NC_</sub> = GND, f = 1MHz, Figure 3		20		pF	
Off-Isolation (Note 6)	V <sub>ISO</sub>	R <sub>L</sub> = 50Ω, C <sub>L</sub> = 5pF, f = 1MHz, Figure 2		-75		dB	
			R <sub>L</sub> = 50Ω, C <sub>L</sub> = 5pF, f = 10MHz, Figure 2	-45			

MAX4620/MAX4630/MAX4640

# ±15kV ESD-Protected, Low-Voltage, Quad, SPST, CMOS Analog Switches

## ELECTRICAL CHARACTERISTICS—SINGLE +5V SUPPLY (continued)

(V+ = +4.5V to +5.5V, V<sub>IH</sub> = 2.4V, V<sub>IL</sub> = 0.8V, T<sub>A</sub> = T<sub>MIN</sub> to T<sub>MAX</sub>, unless otherwise specified. Typical values are at V+ = +5V, T<sub>A</sub> = +25°C.) (Note 2)

PARAMETER	SYMBOL	CONDITIONS	MIN	TYP	MAX	UNITS
Crosstalk (Note 7)	V <sub>CT</sub>	R <sub>L</sub> = 50Ω, C <sub>L</sub> = 5pF, f = 1MHz, Figure 5		-90		dB
		R <sub>L</sub> = 50Ω, C <sub>L</sub> = 5pF, f = 10MHz, Figure 5		-70		
Total Harmonic Distortion	THD	R <sub>L</sub> = 600Ω, f = 20Hz to 20kHz		0.015		%
ESD Silicon-Controlled Rectifier (SCR) Holding Current	I <sub>H</sub>			110		mA
ESD SCR Holding Voltage	V <sub>H</sub>			3		V
<b>POWER SUPPLY</b>						
Power-Supply Range	V+		2		12	V
Positive Supply Current	I+	V+ = 5.5V, V <sub>IN</sub> = 0 or V+	T <sub>A</sub> = +25°C		1	μA
			T <sub>A</sub> = T <sub>MIN</sub> to T <sub>MAX</sub>		10	

## ELECTRICAL CHARACTERISTICS—SINGLE +3V SUPPLY

(V+ = +2.7V to +3.6V, V<sub>IH</sub> = 2.0V, V<sub>IL</sub> = 0.6V, T<sub>A</sub> = T<sub>MIN</sub> to T<sub>MAX</sub>, unless otherwise specified. Typical values are at T<sub>A</sub> = +25°C.) (Note 2)

PARAMETER	SYMBOL	CONDITIONS	MIN	TYP	MAX	UNITS
<b>ANALOG SWITCH</b>						
Input Voltage Range	V <sub>COM_</sub> , V <sub>NO_</sub> , V <sub>NC_</sub>		0		V+	V
On-Resistance	R <sub>ON</sub>	V+ = 2.7V, I <sub>COM_</sub> = 1mA, V <sub>NO_</sub> or V <sub>NC_</sub> = 1.5V	T <sub>A</sub> = +25°C	70	120	Ω
			T <sub>A</sub> = T <sub>MIN</sub> to T <sub>MAX</sub>		150	
On-Resistance Match Between Channels (Notes 3, 8)	ΔR <sub>ON</sub>	V+ = 2.7V, I <sub>COM_</sub> = 1mA, V <sub>NO_</sub> or V <sub>NC_</sub> = 1.5V	T <sub>A</sub> = +25°C	0.6	3	Ω
			T <sub>A</sub> = T <sub>MIN</sub> to T <sub>MAX</sub>		4	
On-Resistance Flatness (Notes 4, 8)	R <sub>FLAT(ON)</sub>	V+ = 2.7; I <sub>COM_</sub> = 1mA; V <sub>NO_</sub> or V <sub>NC_</sub> = 0.5V, 1.5V, 2.2V	T <sub>A</sub> = +25°C	6	12	Ω
			T <sub>A</sub> = T <sub>MIN</sub> to T <sub>MAX</sub>		15	
<b>LOGIC INPUT</b>						
IN_ Input High	V <sub>IH</sub>		2.0			V
IN_ Input Low	V <sub>IL</sub>				0.6	V
Logic Input Leakage Current	I <sub>IN</sub>	V <sub>IN</sub> = 0 or V+	-1		1	μA

# ±15kV ESD-Protected, Low-Voltage, Quad, SPST, CMOS Analog Switches

**MAX4620/MAX4630/MAX4640**

## ELECTRICAL CHARACTERISTICS—SINGLE +3V SUPPLY (continued)

(V+ = +2.7V to +3.6V, V<sub>IH</sub> = 2.0V, V<sub>IL</sub> = 0.6V, T<sub>A</sub> = T<sub>MIN</sub> to T<sub>MAX</sub>, unless otherwise specified. Typical values are at T<sub>A</sub> = +25°C.) (Note

PARAMETER	SYMBOL	CONDITIONS	MIN	TYP	MAX	UNITS
<b>SWITCH DYNAMIC CHARACTERISTICS</b>						
Turn-On Time	t <sub>ON</sub>	V <sub>COML</sub> = 1.5V, R <sub>L</sub> = 300Ω, C <sub>L</sub> = 35pF, Figure 1	T <sub>A</sub> = +25°C	150	250	ns
			T <sub>A</sub> = T <sub>MIN</sub> to T <sub>MAX</sub>		300	
Turn-Off Time	t <sub>OFF</sub>	V <sub>COML</sub> = 1.5V, R <sub>L</sub> = 300Ω, C <sub>L</sub> = 35pF, Figure 1	T <sub>A</sub> = +25°C	60	100	ns
			T <sub>A</sub> = T <sub>MIN</sub> to T <sub>MAX</sub>		150	
Break-Before-Make (MAX4640 only)		V <sub>COML</sub> = 1.5V, R <sub>L</sub> = 300Ω, C <sub>L</sub> = 35pF	T <sub>A</sub> = +25°C	5		ns
			T <sub>A</sub> = T <sub>MIN</sub> to T <sub>MAX</sub>	4		
Charge Injection	Q	V <sub>GEN</sub> = 1.5V, C <sub>L</sub> = 1.0nF, R <sub>GEN</sub> = 0, Figure 4		5		pC
ESD SCR Holding Current	I <sub>H</sub>			110		mA
ESD SCR Holding Voltage	V <sub>H</sub>			3		V
<b>POWER SUPPLY</b>						
Power-Supply Range	V+		2		12	V
Positive Supply Current	I+	V+ = 3.6V, V <sub>IN</sub> = 0 or V+	T <sub>A</sub> = +25°C		1	μA
			T <sub>A</sub> = T <sub>MIN</sub> to T <sub>MAX</sub>		10	

**Note 2:** The algebraic convention, where the most negative value is a minimum and the most positive value is a maximum, is used in this data sheet.

**Note 3:**  $\Delta R_{ON} = R_{ON(MAX)} - R_{ON(MIN)}$ .

**Note 4:** Flatness is defined as the difference between the maximum and the minimum values of on-resistance as measured over the specified analog signal ranges.

**Note 5:** Leakage parameters are 100% tested at T<sub>A(max)</sub>, and guaranteed by correlation at +25°C.

**Note 6:** Off-Isolation =  $20 \log_{10}(V_{COM} / V_{NO})$ , V<sub>COM</sub> = output, V<sub>NO</sub> = input to off switch.

**Note 7:** Between any two switches.

**Note 8:** Guaranteed by design.

# **$\pm 15\text{kV}$ ESD-Protected, Low-Voltage, Quad, SPST, CMOS Analog Switches**

## **Typical Operating Characteristics**

( $V_+ = +5\text{V}$ ,  $T_A = +25^\circ\text{C}$ , unless otherwise specified.)

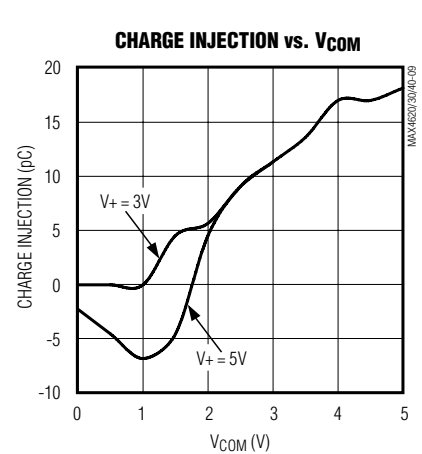
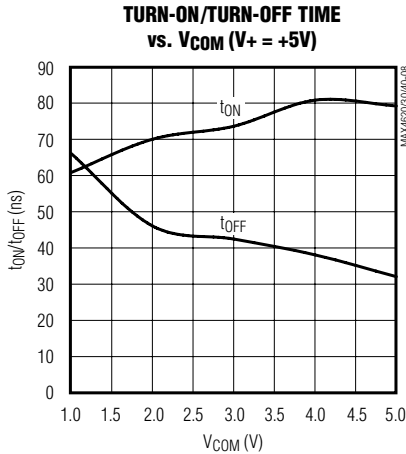
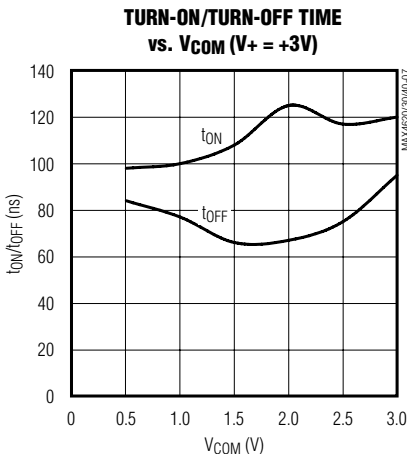
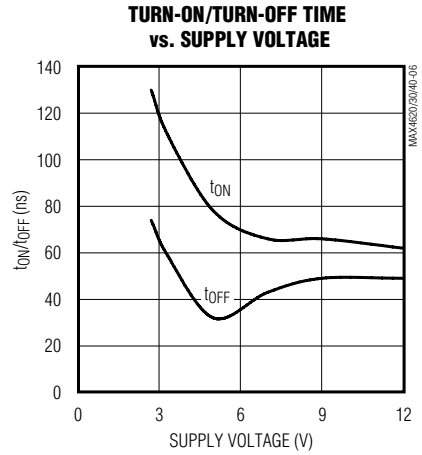
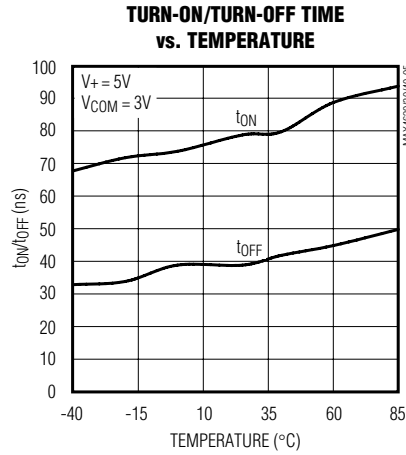
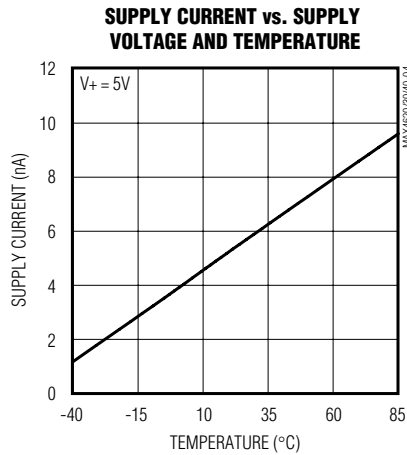
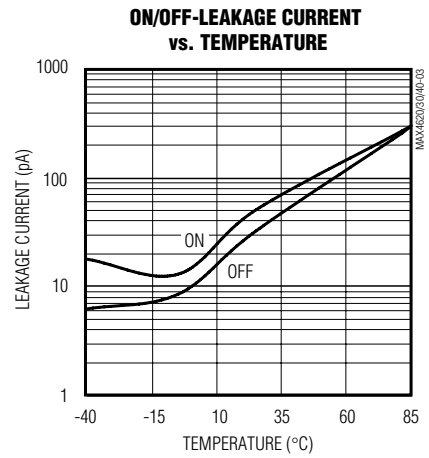
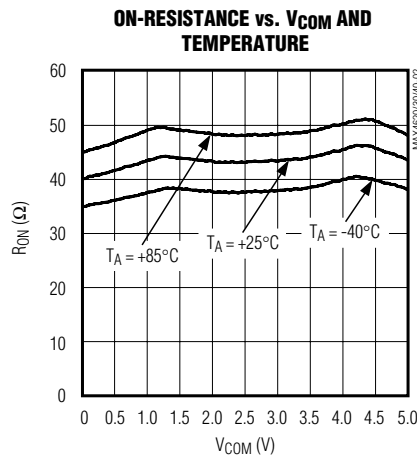
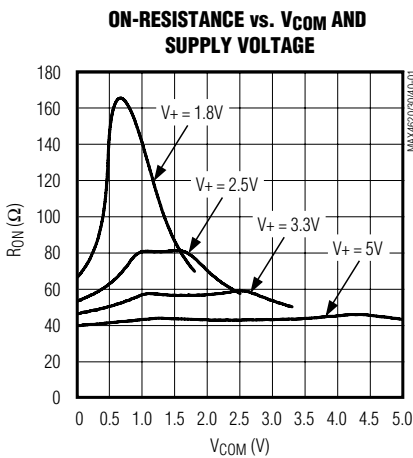

# ±15kV ESD-Protected, Low-Voltage, Quad, SPST, CMOS Analog Switches

## Typical Operating Characteristics (continued)

(V<sub>+</sub> = +5V, T<sub>A</sub> = +25°C, unless otherwise specified.)



## Pin Description

PIN			NAME	FUNCTION
MAX4620	MAX4630	MAX4640		
1	—	1	NO1	Analog Switch 1 – Normally Open
—	1	—	NC1	Analog Switch 1 – Normally Closed
2	2	2	COM1	Analog Switch 1 – Common
3	—	3	NO2	Analog Switch 2 – Normally Open
—	3	—	NC2	Analog Switch 2 – Normally Closed
4	4	4	COM2	Analog Switch 2 – Common
5	5	5	IN2	Digital Control Input 2
6	6	6	IN3	Digital Control Input 3
7	7	7	GND	Ground
8	—	—	NO3	Analog Switch 3 – Normally Open
—	8	8	NC3	Analog Switch 3 – Normally Closed
9	9	9	COM3	Analog Switch 3 – Common
10	10	10	COM4	Analog Switch 4 – Common
11	—	—	NO4	Analog Switch 4 – Normally Open
—	11	11	NC4	Analog Switch 4 – Normally Closed
12	12	12	IN4	Digital Control Input 4
13	13	13	IN1	Digital Control Input 1
14	14	14	V+	Positive Supply Voltage Input

MAX4620/MAX4630/MAX4640

# ±15kV ESD-Protected, Low-Voltage, Quad, SPST, CMOS Analog Switches

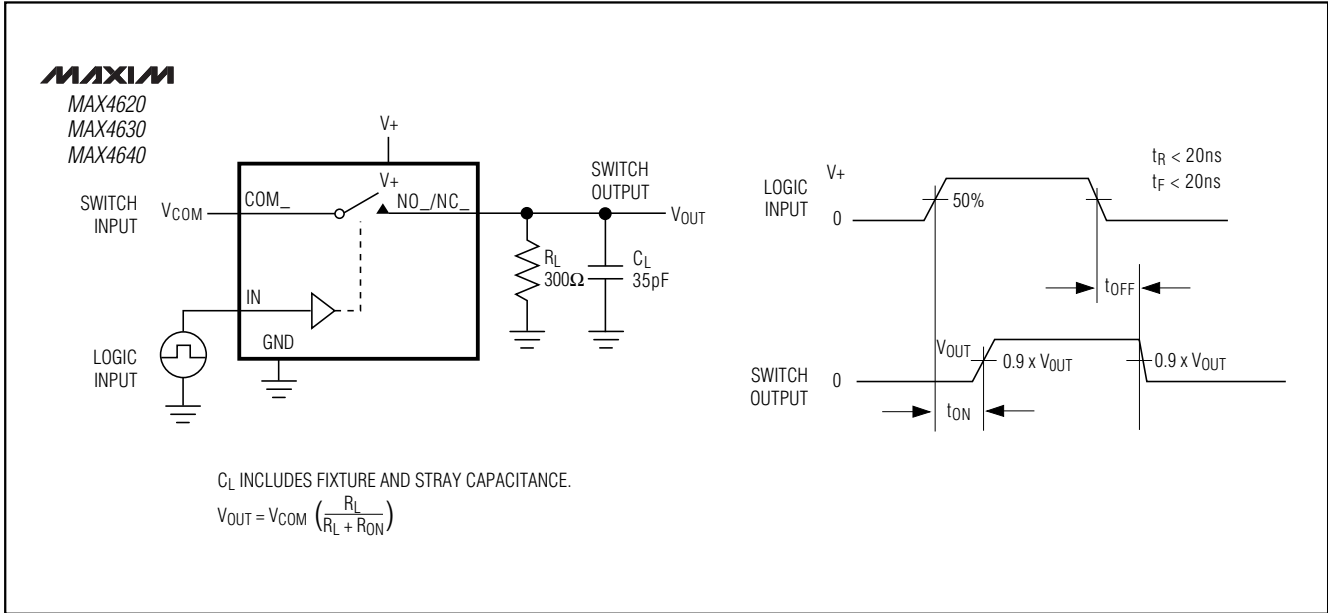

Figure 1. Switching Time



Figure 2. Off-Isolation/On-Channel Bandwidth



Figure 3. Channel Off/On-Capacitance



# ±15kV ESD-Protected, Low-Voltage, Quad, SPST, CMOS Analog Switches

**MAX4620/MAX4630/MAX4640**



Figure 4. Charge Injection



Figure 5. Crosstalk

## Detailed Description

The MAX4620/MAX4630/MAX4640 are quad SPST CMOS analog switches with circuitry providing ±15kV ESD protection on the NO and NC pins. The CMOS switch construction provides rail-to-rail signal handling while consuming virtually no power. Each of the four switches is independently controlled by a TTL/CMOS-level-compatible digital input.

## Applications Information

Do not exceed the absolute maximum ratings because stresses beyond the listed ratings may cause permanent damage to the device.

Proper power-supply sequencing is recommended for all CMOS devices. Always sequence V+ on first, followed by the logic inputs, NO/NC, or COM.

## Operating Considerations for High-Voltage Supply

The MAX4620/MAX4630/MAX4640 are capable of +12V single-supply operation with some precautions. The absolute maximum rating for V+ is 13V (referenced to GND). When operating near this region, bypass V+ with a minimum 0.1μF capacitor to ground as close to the IC as possible.

# ±15kV ESD-Protected, Low-Voltage, Quad, SPST, CMOS Analog Switches

## ±15kV ESD Protection

The MAX4620/MAX4630/MAX4640 are ±15kV ESD-protected at the NC/NO terminals. To accomplish this, bidirectional SCRs are included on-chip between these terminals. When the voltages at these terminals go Beyond-the-Rails™, the corresponding SCR turns on in a few nanoseconds and bypasses the surge safely to ground. This method is superior to using diode clamps to the supplies because unless the supplies are very carefully decoupled through low ESR capacitors, the ESD current through the diode clamp could cause a significant spike in the supplies. This may damage or compromise the reliability of any other chip powered by those same supplies.

There are diodes from NC/NO to the supplies in addition to the SCRs. There is a resistance in series with each of these diodes to limit the current into the supplies during an ESD strike. The diodes protect these terminals from overvoltages that are not a result of ESD strikes. These diodes also protect the device from improper power-supply sequencing.

Once the SCR turns on because of an ESD strike, it continues to be on until the current through it falls below its “holding current.” The holding current is typically 110mA in the positive direction (current flowing into the NC/NO terminal) at room temperature (see Supply Current vs. Temperature in the *Typical Operating Characteristics*). Design the system so that any sources connected to NC/NO are current limited to a value below the holding current to ensure the SCR turns off when the ESD event is finished and normal operation is resumed. Also, keep in mind that the holding current varies significantly with temperature. The worst case is at +85°C when the holding currents drop to 70mA. Since this is a typical number to guarantee turn-off of the SCRs under all conditions, the sources connected to these terminals should be current limited to not more than half this value. When the SCR is latched, the voltage across it is approximately 3V, depending on the polarity of the pin current. The supply voltages do not appreciably affect the holding current. The sources connected to the COM side of the switches do not need to be current limited since the switches turn off internally when the corresponding SCR(s) latches.

Even though most of the ESD current flows to GND through the SCRs, a small portion of it goes into V+. Therefore, it is a good idea to bypass the V+ with 0.1µF capacitors directly to the ground plane.

ESD protection can be tested in various ways. Transmitter outputs and receiver inputs are characterized for protection to the following:

- ±15kV using the Human Body Model
- ±8kV using the Contact Discharge method specified in IEC 1000-4-2 (formerly IEC 801-2)
- ±15kV using the Air-Gap Discharge method specified in IEC 1000-4-2 (formerly IEC 801-2)

## ESD Test Conditions

Contact Maxim Integrated Products for a reliability report that documents test setup, methodology, and results.

## Human Body Model

Figure 6 shows the Human Body Model, and Figure 7 shows the waveform it generates when discharged into a low impedance. This model consists of a 100pF capacitor charged to the ESD voltage of interest, which can be discharged into the test device through a 1.5kΩ resistor.

## IEC 1000-4-2

The IEC 1000-4-2 standard covers ESD testing and performance of finished equipment; it does not specifically refer to ICs. The MAX4620/MAX4630/MAX4640 enable the design of equipment that meets Level 4 (the highest level) of IEC 1000-4-2, without additional ESD protection components.

The major difference between tests done using the Human Body Model and IEC 1000-4-2 is higher peak current in IEC 1000-4-2. Because series resistance is lower in the IEC 1000-4-2 ESD test model (Figure 8), the ESD withstand voltage measured to this standard is generally lower than that measured using the Human Body Model. Figure 9 shows the current waveform for the ±8kV IEC 1000-4-2 Level 4 ESD Contact Discharge test.

The Air-Gap test involves approaching the device with a charged probe. The Contact Discharge method connects the probe to the device before the probe is energized.

## Chip Information

TRANSISTOR COUNT: 156

PROCESS: CMOS

*Beyond-the-Rails is a trademark of Maxim Integrated Products.*

# ±15kV ESD-Protected, Low-Voltage, Quad, SPST, CMOS Analog Switches

MAX4620/MAX4630/MAX4640



Figure 6. Human Body ESD Test Model



Figure 7. Human Body Model Current Waveform



Figure 8. IEC 1000-4-2 ESD Test Model



Figure 9. IEC 1000-4-2 ESD Generator Current Waveform

# ±15kV ESD-Protected, Low-Voltage, Quad, SPST, CMOS Analog Switches

## Pin Configurations/Functional Diagrams/Truth Tables (continued)



### Ordering Information (continued)

PART	TEMP. RANGE	PIN-PACKAGE
MAX4640EUD	-40°C to +85°C	14 TSSOP
MAX4640ESD	-40°C to +85°C	14 SO
MAX4640EPD	-40°C to +85°C	14 DIP

# ±15kV ESD-Protected, Low-Voltage, Quad, SPST, CMOS Analog Switches

## Package Information

MAX4620/MAX4630/MAX4640

**COMMON DIMENSIONS**

	MILLIMETERS		INCHES	
	MIN.	MAX.	MIN.	MAX.
A	—	1.10	—	.043
A <sub>1</sub>	0.05	0.15	.002	.006
A <sub>2</sub>	0.85	0.95	.033	.037
b	0.19	0.30	.007	.012
b <sub>1</sub>	0.19	0.25	.007	.010
c	0.090	0.20	.0035	.008
c <sub>1</sub>	0.090	0.135	.0035	.0053
D	SEE VARIATIONS		SEE VARIATIONS	
E	4.30	4.50	.169	.177
e	0.65 BSC		.026 BSC	
H	6.25	6.50	.246	.256
L	0.50	0.70	.020	.028
N	SEE VARIATIONS		SEE VARIATIONS	
Y	2.85	3.15	.112	.124
α	0°	8°	0°	8°

JEDEC	MO-153	N	VARIATIONS				
			MILLIMETERS		INCHES		
			MIN.	MAX.	MIN.	MAX.	
	AB	14	D	4.90	5.10	.193	.201
	AC	16	D	4.90	5.10	.193	.201
	AC-EP	16	D	4.90	5.10	.193	.201
			X	2.85	3.15	.112	.124
	AD	20	D	6.40	6.60	.252	.260
	AD-EP	20	D	6.40	6.60	.252	.260
			X	4.00	4.34	.157	.171
	AE	24	D	7.70	7.90	.303	.311
	AF	28	D	9.60	9.80	.378	.386
	AF-EP		D	9.60	9.80	.378	.386
			X	5.35	5.65	.211	.222

**NOTES:**

- DIMENSIONS D AND E DO NOT INCLUDE FLASH.
- MOLD FLASH OR PROTRUSIONS NOT TO EXCEED .15 mm PER SIDE.
- CONTROLLING DIMENSION: MILLIMETER.
- MEETS JEDEC OUTLINE MO-153 VARIATIONS AB, AC, AD, AE, AF.
- DIMENSIONS X AND Y APPLY TO EXPOSED PAD (EP) VERSIONS ONLY.
- EXPOSED PAD FLUSH WITH BOTTOM OF PACKAGE WITHIN .002".

TSSOP-EP8

# ±15kV ESD-Protected, Low-Voltage, Quad, SPST, CMOS Analog Switches

## Package Information (continued)

	INCHES		MILLIMETERS	
	MIN	MAX	MIN	MAX
A	0.053	0.069	1.35	1.75
A1	0.004	0.010	0.10	0.25
B	0.014	0.019	0.35	0.49
C	0.007	0.010	0.19	0.25
e	0.050		1.27	
E	0.150	0.157	3.80	4.00
H	0.228	0.244	5.80	6.20
h	0.010	0.020	0.25	0.50
L	0.016	0.050	0.40	1.27

	INCHES		MILLIMETERS		N	MS012
	MIN	MAX	MIN	MAX		
D	0.189	0.197	4.80	5.00	8	A
D	0.337	0.344	8.55	8.75	14	B
D	0.386	0.394	9.80	10.00	16	C

NOTES:

1. D&E DO NOT INCLUDE MOLD FLASH
2. MOLD FLASH OR PROTRUSIONS NOT TO EXCEED .15mm (.006")
3. LEADS TO BE COPLANAR WITHIN .102mm (.004")
4. CONTROLLING DIMENSION: MILLIMETER
5. MEETS JEDEC MS012-XX AS SHOWN IN ABOVE TABLE
6. N = NUMBER OF PINS

**MAXIM**  
120 SAN GABRIEL DR. SAN DIEGO, CA 92161 FAX (619) 737-7754  
PROPRIETARY INFORMATION

PACKAGE FAMILY OUTLINE: SOIC .150"

1/1

21-0041 A  
DOCUMENT CONTROL NUMBER REV

# ±15kV ESD-Protected, Low-Voltage, Quad, SPST, CMOS Analog Switches

## Package Information (continued)

MAX4620/MAX4630/MAX4640

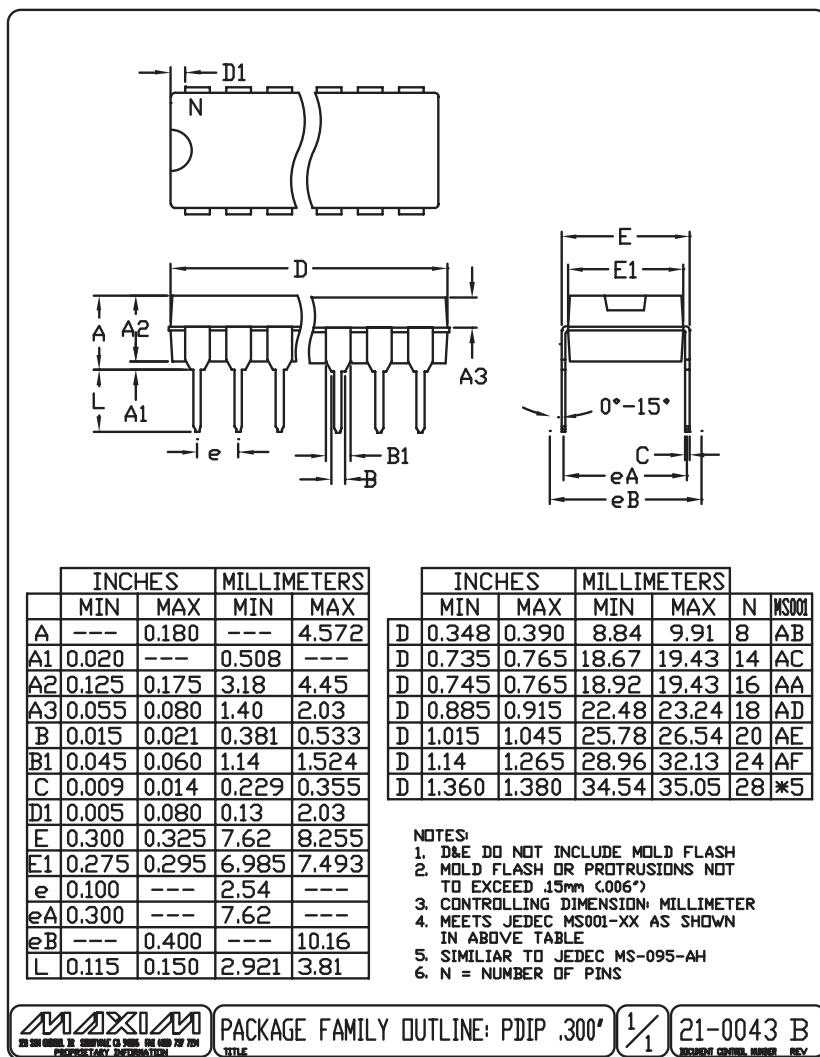

# ***±15kV ESD-Protected, Low-Voltage, Quad, SPST, CMOS Analog Switches***

## **NOTES**

*Maxim cannot assume responsibility for use of any circuitry other than circuitry entirely embodied in a Maxim product. No circuit patent licenses are implied. Maxim reserves the right to change the circuitry and specifications without notice at any time.*

**16 \_\_\_\_\_ Maxim Integrated Products, 120 San Gabriel Drive, Sunnyvale, CA 94086 408-737-7600**