

This document is the property of Amphenol Corporation and is delivered on the express condition that it is not to be disclosed, reproduced or used, in whole or in part, for manufacture or sale by anyone other than Amphenol Corporation without its prior consent, & that no right is granted to disclose or to use any information in this document.

REVISIONS				
SYM	ECN	DESCRIPTION	DATE	APPROVED
A1	HKXXXX	Release to customer	10/20/04	IP

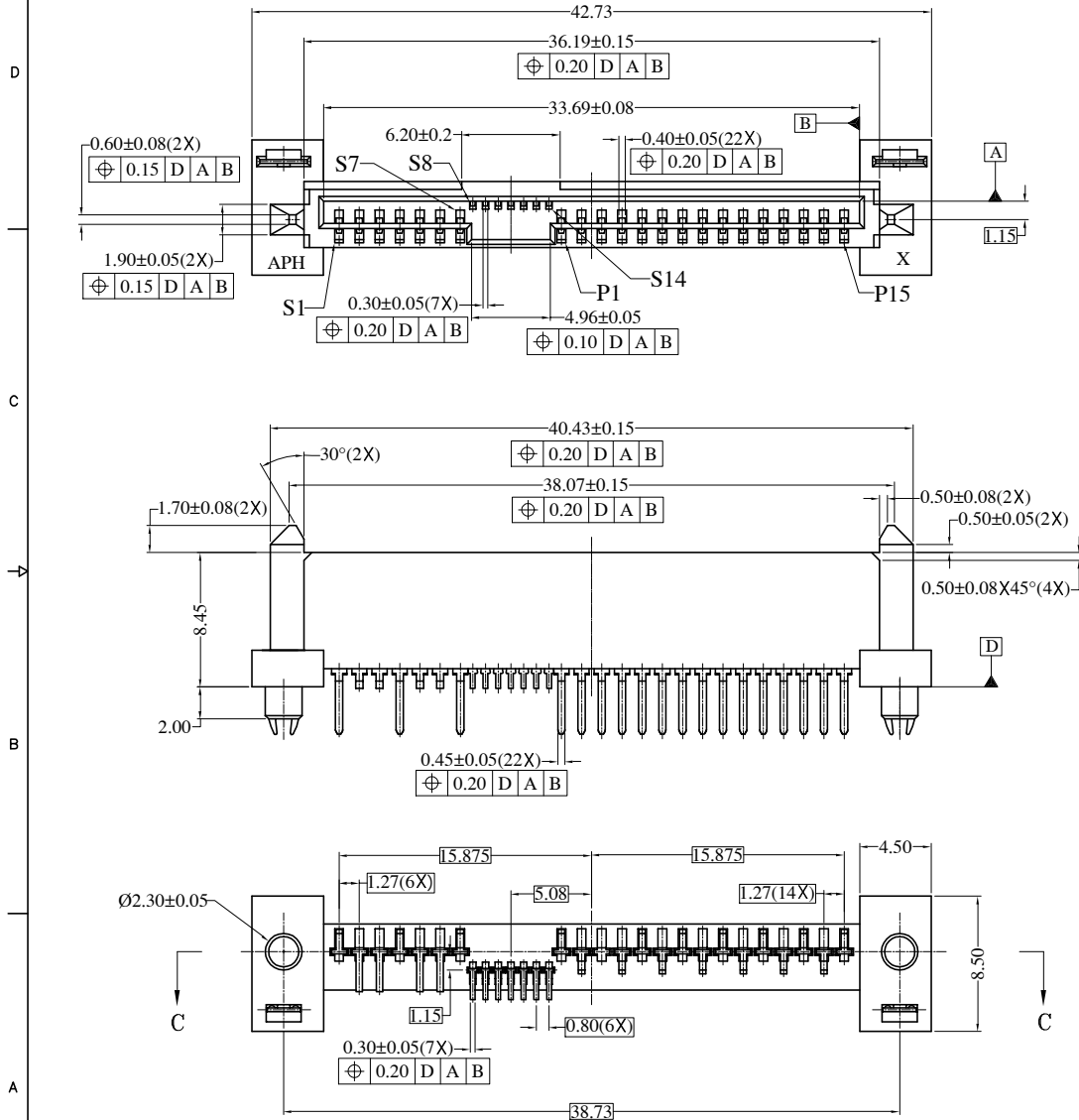

NOTES:

- MATERIAL HOUSING: LCP G431 30% GLASS FILLED UL94V-0, BLACK. OR EQUIVALENT HIGH TEMPERATURE PLASTIC.  
CONTACT: PHOSPHOR BRONZE  
PLATING: REFER TO P/N SYSTEM ON MATING AREA  
1.27~2.54um NICKEL UNDERPLATE OVERALL  
2.54~5.08um PURE TIN ON SOLDER TAIL  
SOLDER CLIP: COPPER ALLOY, 2.54~5.08um PURE TIN PLATED OVERALL  
1.27~2.54um NICKEL UNDERPLATE
- ELECTRICAL SPECIFICATION: CURRENT RATING: 1.5A  
CONTACT RESISTANCE: 30mΩ MAX.  
INSULATOR RESISTANCE: 1000MΩ MIN.  
DIELECTRIC WITHSTANDING VOLTAGE: 500 V AC
- PREMATING AT P4 & P12
- RECOMMENDED PCB THICKNESS 2.54±0.15
- ORDER P/N SYSTEM: SAS-F511-001-X-C

MATING AREA PLATING  
1- 0.76um MIN Au.  
2- 0.38um MIN Au.  
A- Gold FLASH

Customer Drawing

ITEM	PART NO.	REQ'D	DESCRIPTION
PARTS LIST			
UNLESS OTHERWISE SPECIFIED TOLERANCES		APPROVAL	DATE
U.S. METRIC		DRAWN RAN.XIAO	10/20/04
.X +/-		CHECKED IP	10/20/04
.XX +/-		CHECKED	
.XXX +/-			
FRACTIONS +/-			
ANGLES +/-			
FOR MATERIALS AND FINISHES SEE NOTES		DRAWING FILE : PE MASTER DRAWING SAS C845-F511-001-X-C	
REMOVE SHARP EDGES		ANGLE OF PROJECTION	
DIMENSIONS			
U.S.	INCHES-		
(METRIC)	(MM)	SIZE	DRAWING NO.
		A3	C SAS-F511-001-X-C
		SCALE	NONE
		SHEET 1 OF 2	

Amphenol

TITLE  
SAS SOCKET HYBRID

REV. A1

This document is the property of Amphenol Corporation and is delivered on the express condition that it is not to be disclosed, reproduced or used, in whole or in part, for manufacture or sale by anyone other than Amphenol Corporation without its prior consent, & that no right is granted to disclose or to use any information in this document.

REVISIONS				
SYM	ECN	DESCRIPTION	DATE	APPROVED
A1	HKXXXX	Release to customer	10/20/04	IP

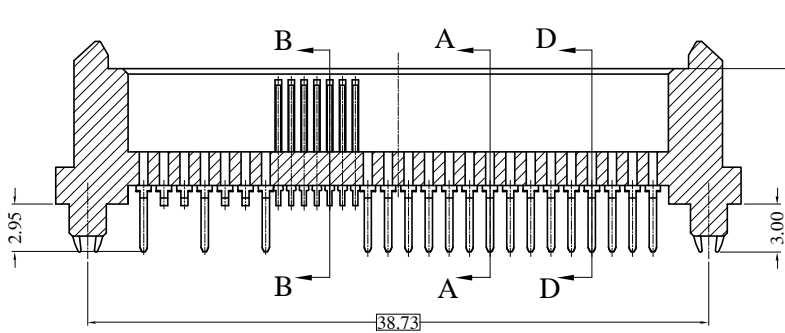

SECTION C-C

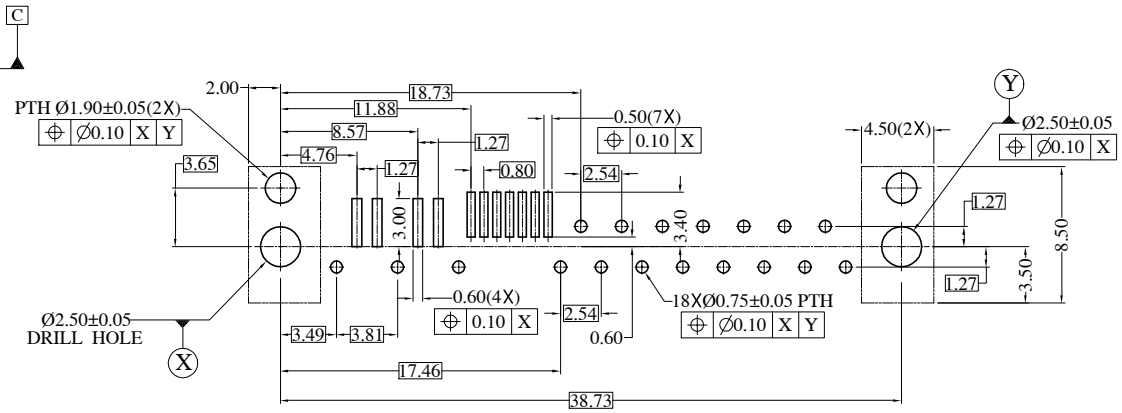

RECOMMENDED PCB LAYOUT  
PCB THICKNESS = 2.54 mm

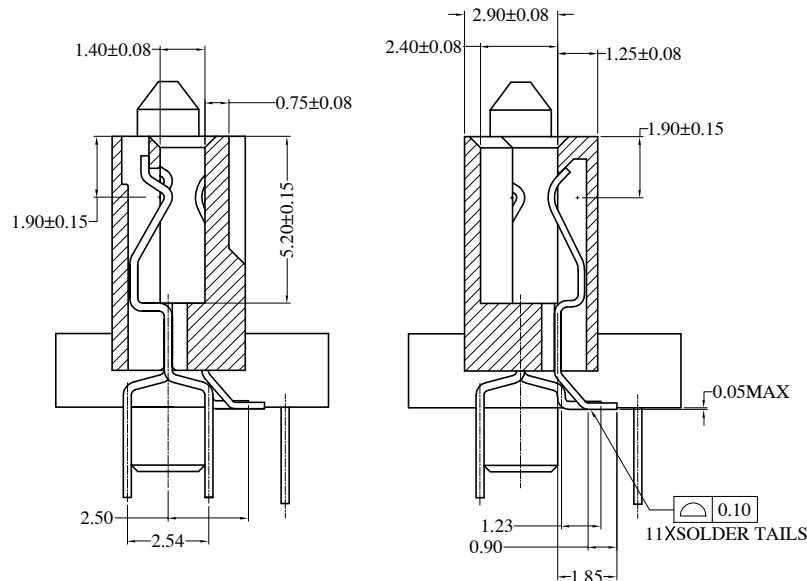

SECTION A-A

SECTION B-B

SECTION D-D

Customer Drawing

ITEM	PART NO.	REQ'D	DESCRIPTION
PARTS LIST			
UNLESS OTHERWISE SPECIFIED TOLERANCES		APPROVAL	DATE
U.S.		DRAWN RAN.XIAO	10/20/04
METRIC		CHECKED IP	10/20/04
.X +/-	±0.20	CHECKED	
.XX +/-	±0.10		
.XXX +/-	±0.10		
FRACTIONS			
ANGLES +/-			
FOR MATERIALS AND FINISHES SEE NOTES		DRAWING FILE :	
REMOVE SHARP EDGES		PE MASTER DRAWING SAS C245-F511-001-X	
DIMENSIONS		ANGLE OF PROJECTION	
U.S.	INCHES-		
(METRIC)	(MM)		
TITLE		SIZE	DRAWING NO.
SAS SOCKET HYBRID		A3	C SAS-F511-001-X-C
SCALE		NONE	REV. A1
SHEET		2	OF 2

This document is the property of Amphenol Corporation and is delivered on the express condition that it is not to be disclosed, reproduced or used, in whole or in part, for manufacture or sale by anyone other than Amphenol Corporation without its prior consent, & that no right is granted to disclose or to use any information in this document.

REVISIONS				
SYM	ECN	DESCRIPTION	DATE	APPROVED
A1	HKXXXX	Initially release	10/20/04	IP

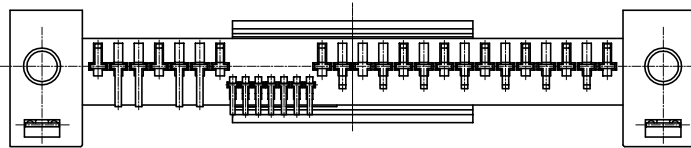
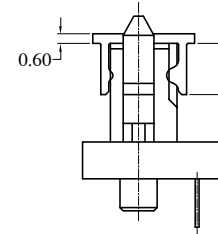
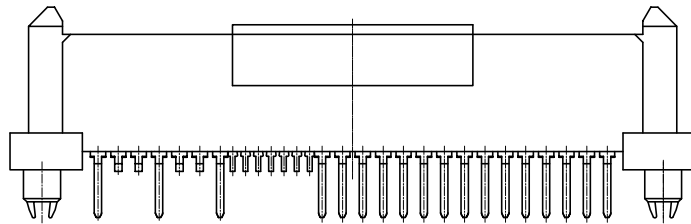
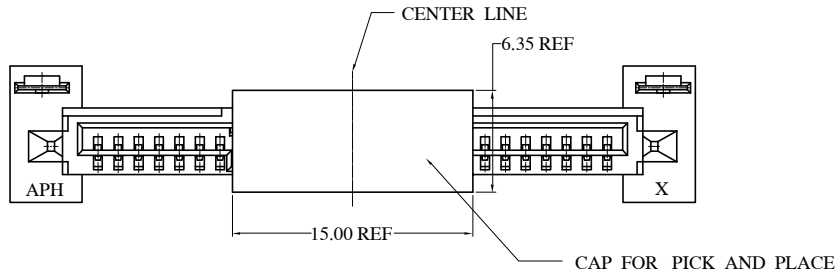

Customer Drawing

ITEM	PART NO.	REQ'D	DESCRIPTION
PARTS LIST			
UNLESS OTHERWISE SPECIFIED TOLERANCES		APPROVAL	DATE
		DRAWN RAN.XIAO	10/20/04
.X +/- / ±0.20		CHECKED IP	10/20/04
.XX +/- / ±0.10		CHECKED	
.XXX +/- / ±0.10		DRAWING FILE : PE MASTER DRAWING SAS CSAS-F511-001-X	
FRACTIONS +/- /		TITLE SAS SOCKET HYBRID	
ANGLES +/- /			
FOR MATERIALS AND FINISHES SEE NOTES		ANGLE OF PROJECTION	
REMOVE SHARP EDGES			
DIMENSIONS			
U.S. INCHES-		SIZE	DRAWING NO.
(METRIC) (MM)		A3	C SAS-F511-001-X-C
		SCALE	NONE
		SHEET 3 OF 3	
		REV.	A1