

RF3604D

**345.0 MHz
SAW Filter**

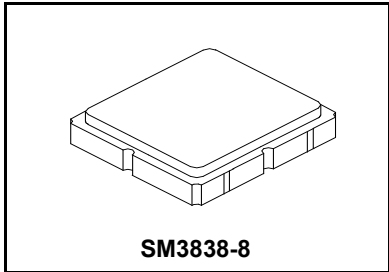

- 342.0 to 348.0 MHz Filter
- Optimized for use with the TRC105 Transceiver
- Balanced 150 ohm IC Interface
- Complies with Directive 2002/95/EC (RoHS) 

Absolute Maximum Ratings

Rating	Value	Units
Input Power Level	+15	dBm
DC Voltage	±5	V
Operating Temperature Range	-40 to +85	°C
Storage Temperature Range in Tape and Reel	-40 to +85	°C

Electrical Characteristics

Characteristic	Sym	Notes	Min	Typ	Max	Units
Center Frequency	f_c			345.0		MHz
1 dB Bandwidth	BW_1			16		MHz
Maximum Insertion Loss, 342.0 to 348.0 MHz	IL_{MAX}			1.5	1.8	dB
Amplitude Ripple, p-p, 342.0 to 348.0 MHz				1.0		
Rejection Referenced to Insertion Loss at 345.0 MHz:						
DC to 285 MHz			39	42		
400 to 500 MHz			43	46		
500 to 900 MHz			45	50		
900 to 1300 MHz			46	53		
1300 to 2000 MHz			27	30		
Source Impedance	Z_S			50		Ω
Balanced Load Impedance	Z_L			150		Ω

Case Style	SM3838-8 3.8 x 3.8 mm Nominal Footprint		
Lid Symbolization (Y=year, WW=week, S=shift) dot=pin 1 indicator	887, YWWS		
Standard Reel Quantity	Reel Size 7 Inch	500 Pieces/Reel	
	Reel Size 13 Inch	3000 Pieces/Reel	

Electrical Connections

Connection	Terminals
Single-ended Port	6
Balanced Port	1, 3
Case Ground	4, 5, 7, 8
No Connection	2



CAUTION: Electrostatic Sensitive Device. Observe precautions for handling.

NOTES:

1. Unless noted otherwise, all specifications apply over the operating temperature range with filter soldered to the specified demonstration board with impedance matching to 50 Ω and measured with 50 Ω network analyzer.
2. Unless noted otherwise, all frequency specifications are referenced to the nominal center frequency, f_c .
3. Rejection is measured as attenuation below the minimum IL point in the passband. Rejection in final user application is dependent on PCB layout and external impedance matching design. See Application Note No. 42 for details.
4. The design, manufacturing process, and specifications of this filter are subject to change.
5. US and international patents may apply.
6. Murata, stylized Murata logo, and Murata N.A., Inc. are registered trademarks of Murata Manufacturing Co., Ltd.

RF3604D-TRC105 Application Circuit

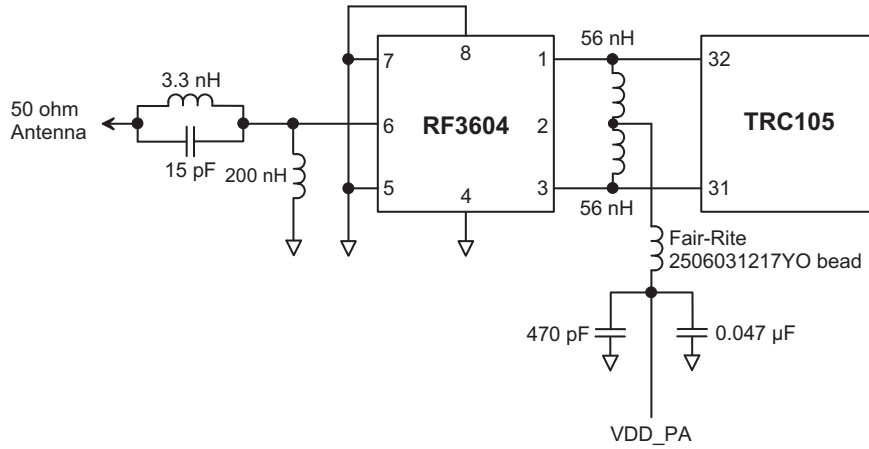

RF3604D 50 Ohm Tuning Network

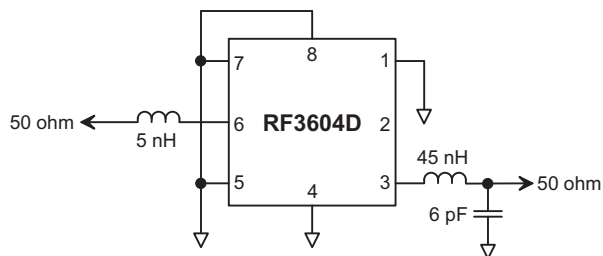

RF3604D Broadband Response, 200 to 2000 MHz

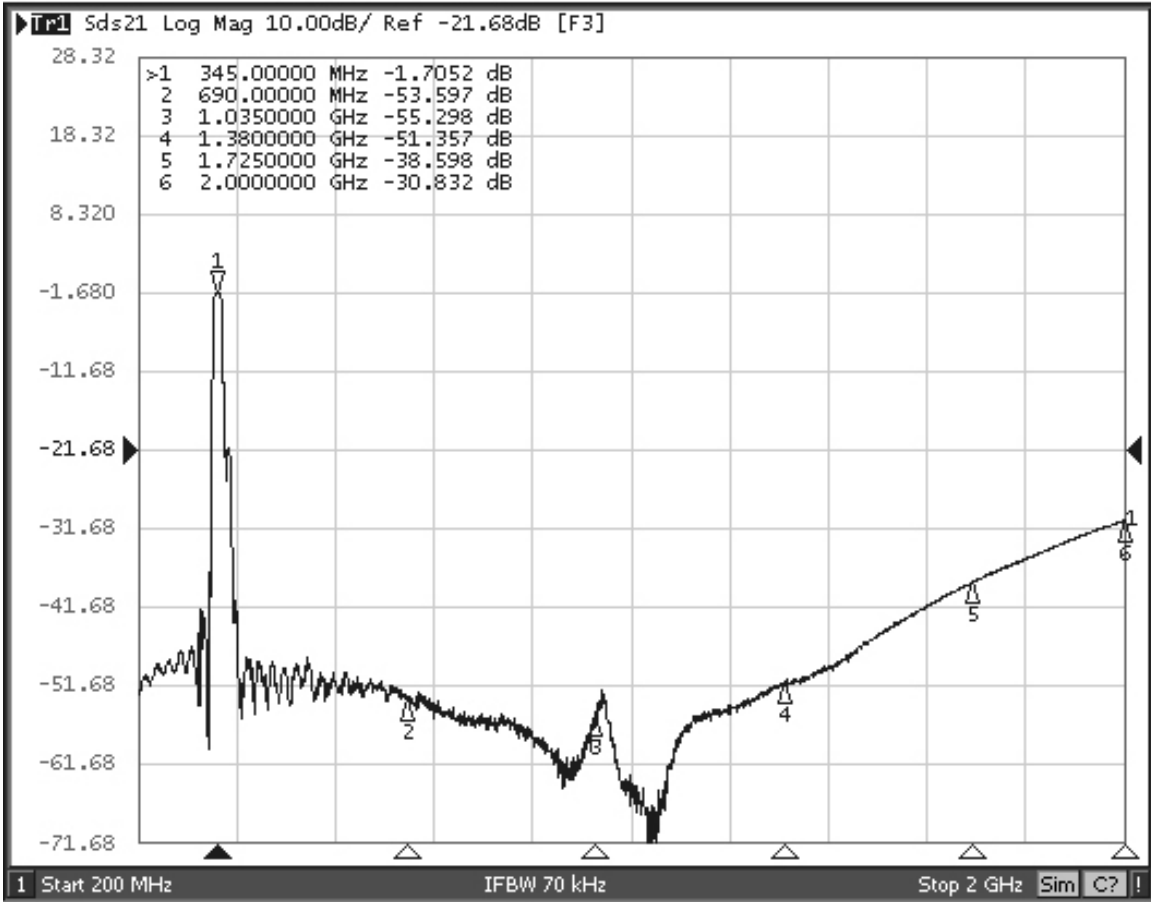

RF3604D Response, 45 to 645 MHz

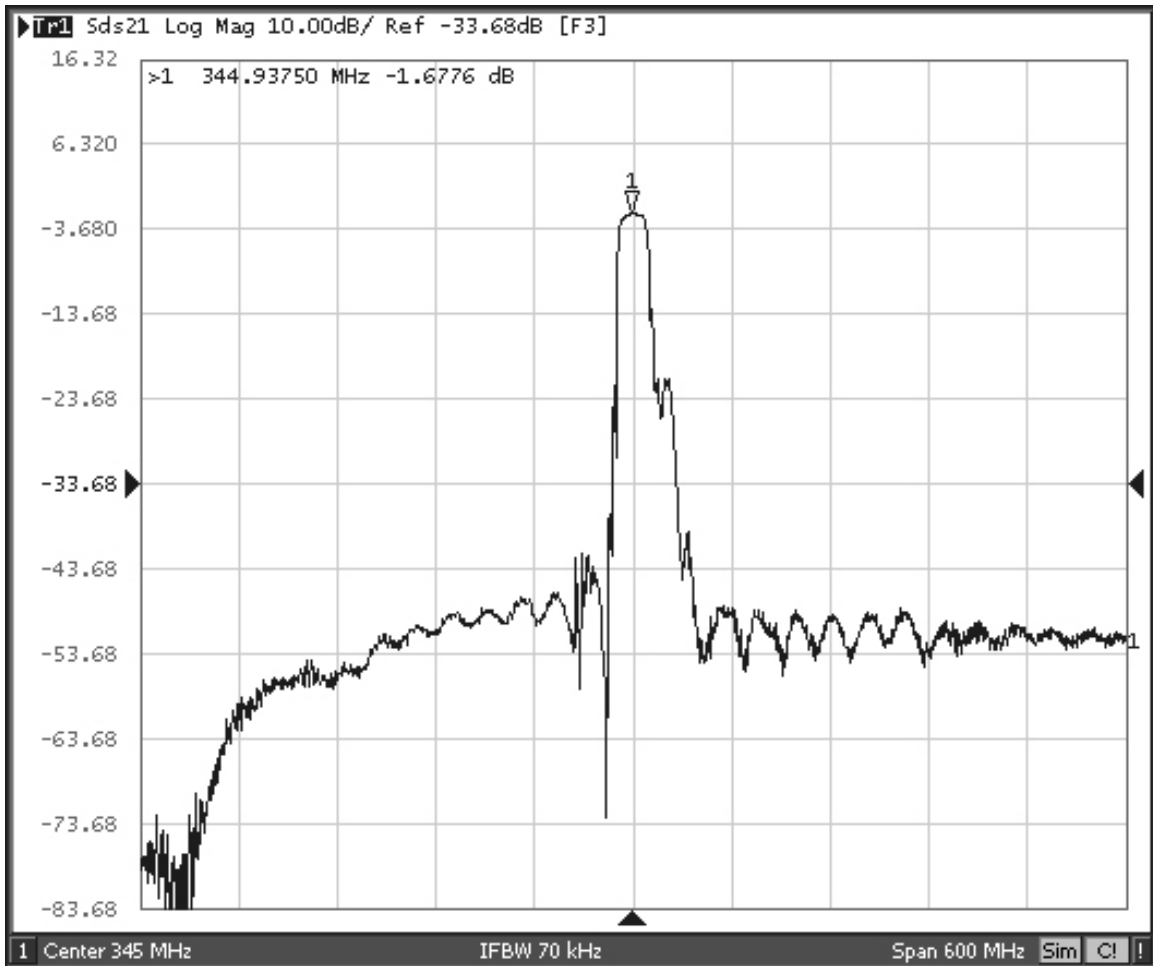

RF3604D Response, 295 to 395 MHz

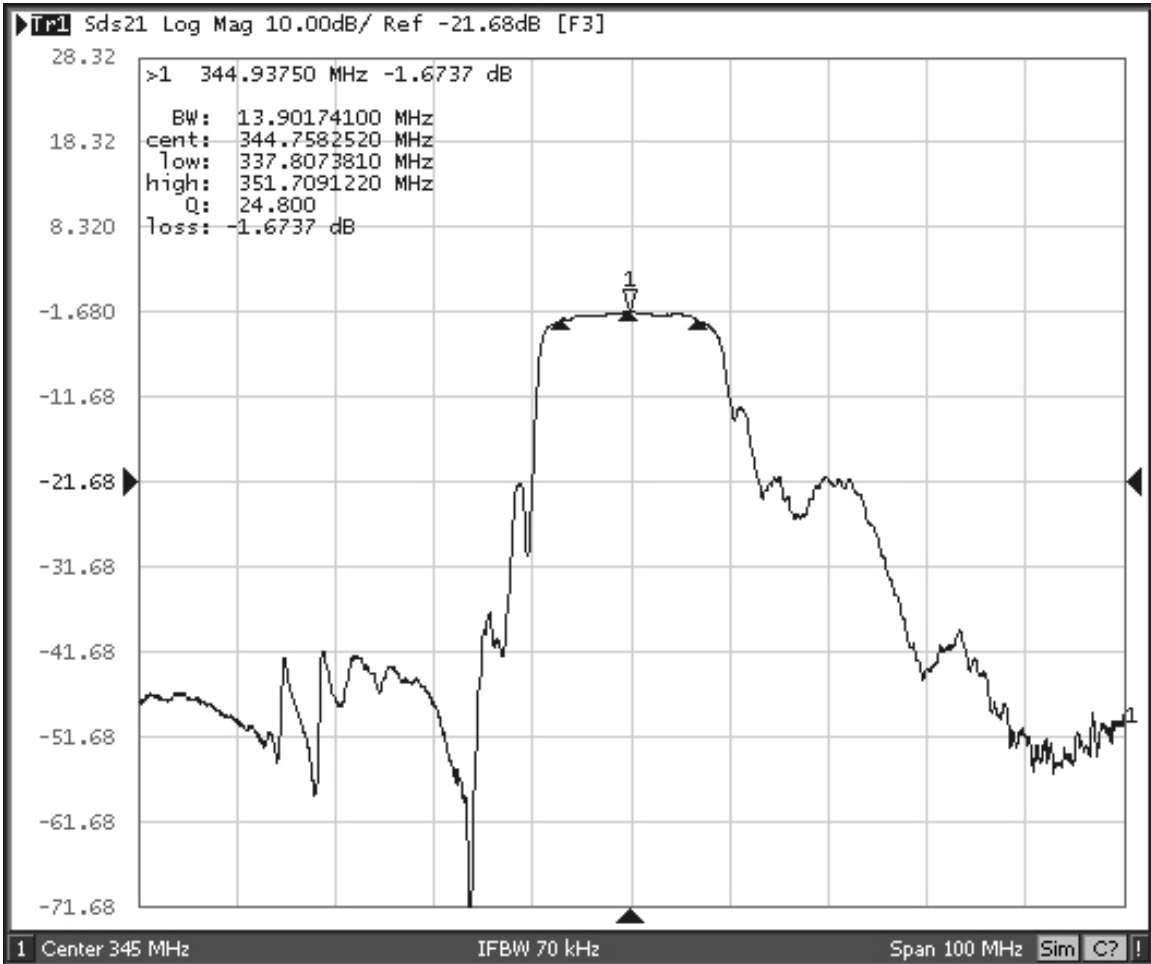

RF3604D Passband Response

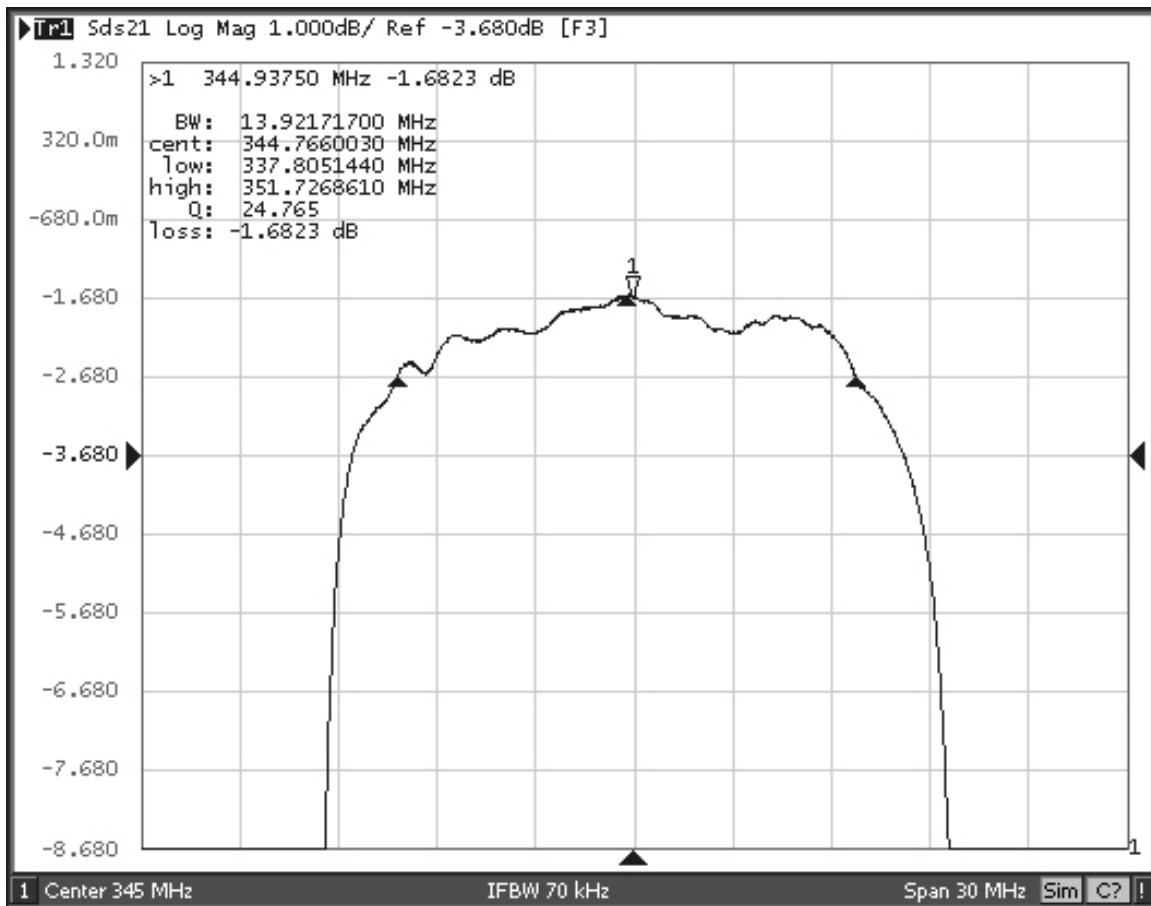

RF3604D Input Impedance Plot

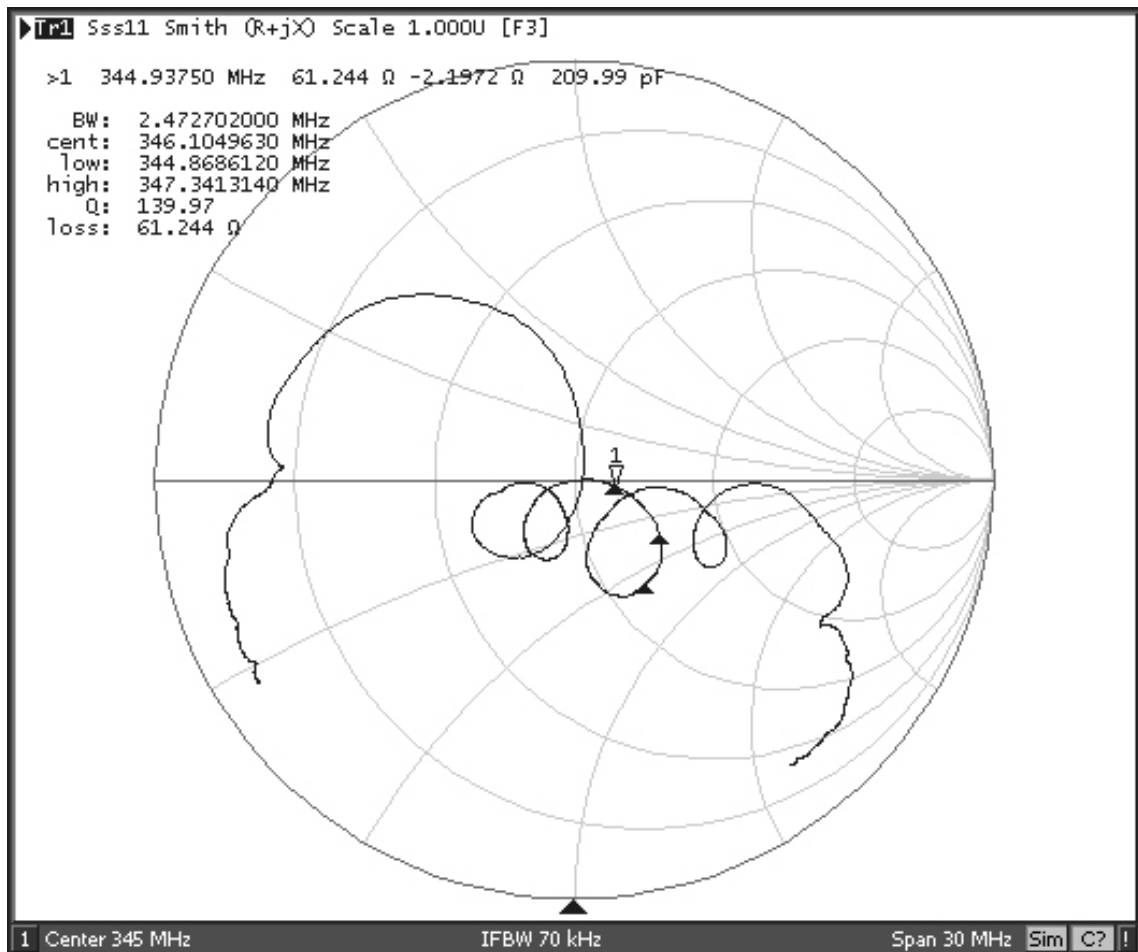

RF3604D Balanced Output Impedance Plot

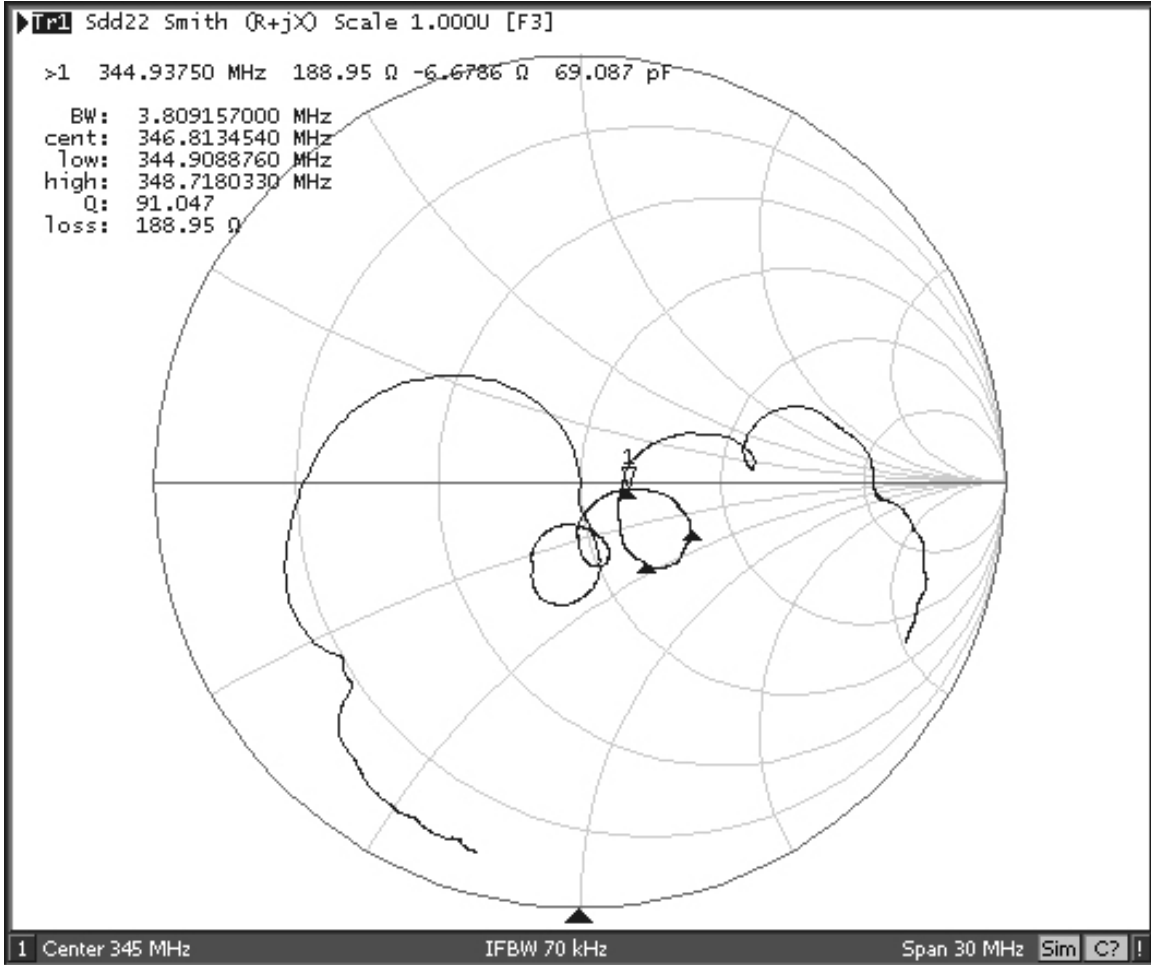

8-Terminal Ceramic Surface-Mount Case 3.8 X 3.8 mm Nominal Footprint

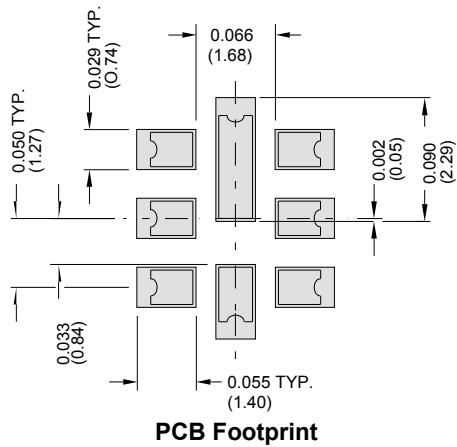

Case Dimensions						
Dimension	mm			Inches		
	Min	Nom	Max	Min	Nom	Max
A	3.6	3.8	4.0	0.142	0.150	0.157
B	3.6	3.8	4.0	0.142	0.150	0.157
C	0.90	1.00	1.1	0.035	0.040	0.043
D	0.80	0.90	1.0	0.031	0.035	0.040
E	0.90	1.00	1.10	0.035	0.040	0.043
F	0.50	0.60	0.70	0.020	0.024	0.028
G	2.39	2.54	2.69	0.090	0.100	0.110
H	1.40	1.75	2.05	0.055	0.069	0.080

Materials	
Solder Pad Plating	0.3 to 1.0 μm Gold over 1.27 to 8.89 μm Nickel
Lid Plating	2.0 to 3.0 μm Nickel
Body	Al_2O_3 Ceramic
Pb Free	

