

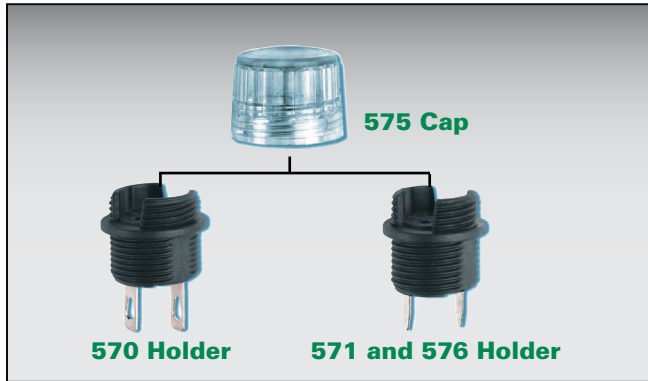

## 570/571/576 Series Fuse Holders with Cap for TE5/TR5 Type Fuses



Agency Approvals			
Agency	Agency File Number		
	570 Series	571 Series	576 Series
	E14721		
	N/A	N/A	40024733



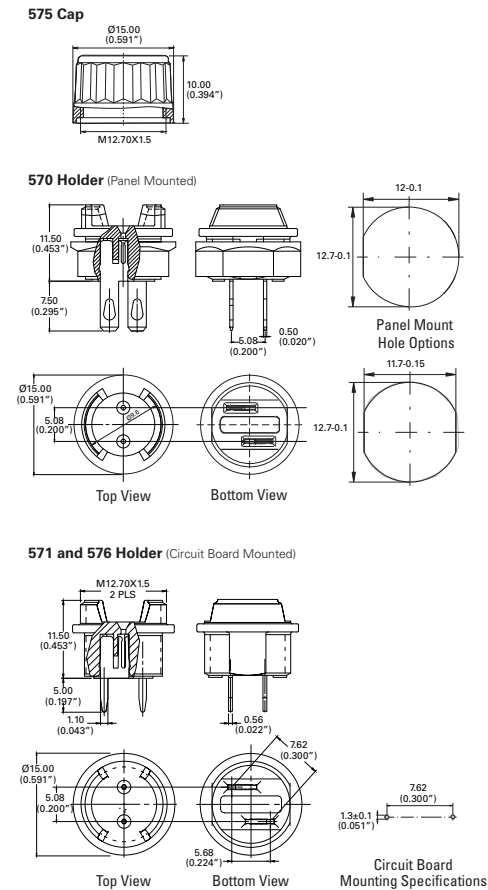





### Dimensions units in mm (inch)



Product Characteristics			
	570 Series	571 Series	576 Series
Compatible Fuses	TR5/TE5		
Materials	<b>Holder:</b> Black Thermoplastic, UL 94 V-0		
	<b>Cap:</b> Transparent Thermoplastic Polycarbonat PC, UL94 V-0		
	<b>Metal Parts:</b> Copper alloy Solderable tinned		
Rated Voltage	250V		
Max. Current/Power:	6.3 A/2.5W	6.3 A/2.5W	6.3 A/1.6W
Mounting	<b>Panel Mounted:</b> 12.7mm diameter D-hole or double D-hole. Admissible torque on plastic hex nut is 1.2Nm	<b>Printed Circuit Board (PCB) Mounted:</b> 7.62mm hole spacing for wave soldering	
	Terminals	Solderable or 2.8mm quick connect – fits 0.5mm tab	Solderable pin terminals – fits 1.3mm hole
Minimum Cross Section	Conductor - 2.5mm <sup>2</sup>		Conducting path - 0.2mm <sup>2</sup>
Unit Weight	2.2g (Holder) 0.94g (Cap)	1.6g (Holder) 0.94g (Cap)	1.6g (Holder) 0.94g (Cap)

Note: Ensure proper fuseholder re-rating.

Ordering Information		
Catalog Number	Description	Packaging
<b>570 0000 0001</b>	<b>Holder:</b> Panel Mount w/ Quick Connect Terminals	Bulk Pack 100
<b>571 0000 0001</b>	<b>Holder:</b> PCB Mount w/ Solderable Pin Terminals - 2.5W Max	Bulk Pack 100
<b>576 0000 0001</b>	<b>Holder:</b> PCB Mount w/ Solderable Pin Terminals - 1.6W Max	Bulk Pack 100
<b>575 0000 0001</b>	<b>Cap:</b> Fits all holders 570, 571 and 576 series	Bulk Pack 100

Additional Information		
		
<a href="#">Datasheet 570 Series</a>	<a href="#">Resources 570 Series</a>	<a href="#">Samples 570 Series</a>
		
<a href="#">Datasheet 571 Series</a>	<a href="#">Resources 571 Series</a>	<a href="#">Samples 571 Series</a>
		
<a href="#">Datasheet 576 Series</a>	<a href="#">Resources 576 Series</a>	<a href="#">Samples 576 Series</a>