



## Heyco-Flex™ III Liquid Tight Fittings

For Flexible, Nonmetallic Liquid Tight Tubing  
Straight-Thru, Snap -in and NPT Hubs

FITS TUBING TRADE SIZE	PART NO.	DESCRIPTION	THREAD SIZE	PART DIMENSIONS											
				A Clearance Hole		B Max O.A. Length		C Thread Length		D Wrenching Nut Thk.		E Flat Size			
	Black			in.	mm.	in.	mm.	in.	mm.	in.	mm.	in.	mm.	in.	mm.
<b>Snap-in Hub*</b>															
1/2	1952	HF3C 1/2-S	N/A	.875	22,2	1.38	35,1	.39	9,9	.09	2,3	.97	24,6		
<b>NPT Hubs</b>															
3/8	9146	HF3C 3/8	3/8	.875	22,2	1.72	43,7	.63	16,0	.20	5,1	1.16	29,5		
1/2	9147	HF3C 1/2	1/2												
3/4	9148	HF3C 3/4	3/4	1.109	28,2	1.84	46,7	.63	16,0	.20	5,1	1.36	34,5		
1	9149	HF3C 1	1	1.375	34,9	1.99	50,6	.78	19,8	.20	5,1	1.62	41,1		

\*Part is not liquid tight or UL Recognized. "Thread Length" indicates length below flange.

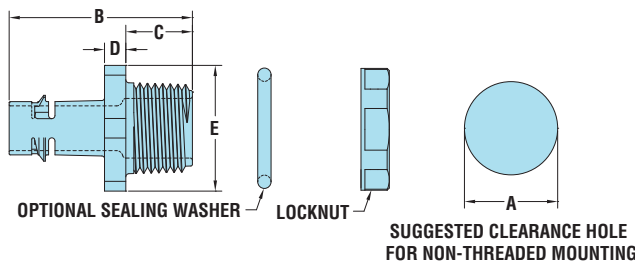

### 90° Sweep, NPT Hubs

FITS TUBING TRADE SIZE	PART NO.	DESCRIPTION	THREAD SIZE	PART DIMENSIONS											
				A Clearance Hole		B Max O.A. Height		C Max O.A. Length		D Thread Length		E Flange Dia.			
	Black			in.	mm.	in.	mm.	in.	mm.	in.	mm.	in.	mm.	in.	mm.
3/8	1955	HF3C 3/8-90R	3/8	.875	22,2	1.75	44,5	2.74	69,6	.52	13,2	1.23	31,2		
1/2	1956	HF3C 1/2-90R	1/2												
3/4	1957	HF3C 3/4-90R	3/4	1.109	28,2	2.10	53,3	3.08	78,2	.52	13,2	1.50	38,1		
1	1958	HF3C 1-90R	1	1.375	34,9	2.67	67,8	3.66	93,0	.69	17,5	1.80	45,7		

Standard color black.

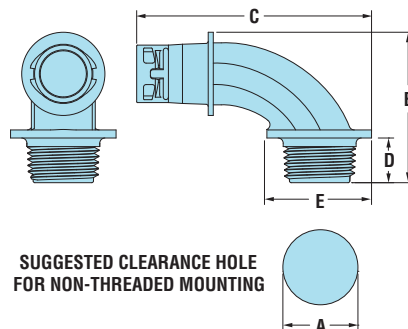

Material	Nylon 6/6
Certifications	e <sub>RU</sub> us Certified to both Canadian and U.S. Requirements File E121095
Flammability Rating	94V-2
Temperature Range	-22°F (-30°C) to 221°F (105°C)
IP Rating	IP 64

- For use with Heyco-Flex III Corrugated Tubing in trade sizes 3/8" through 1". See page 2-1.
- Nontoxic and UV resistant.
- **Rated for NEMA 4 and 4X applications when used with Heyco-Flex III Tubing.**
- Rated for NEMA Type 3R applications.
- Easy, permanent assembly between the tubing and fittings: push the tubing over the fitting ferrule until the tubing clicks into place.
- Lightweight and lower installed cost.
- Quick and easy installation.
- Suitable for use in high vibration or flexing applications (automotive equipment, fiber optics, computer and peripherals, lab equipment, robotics, etc.).
- Resist salt water, weak acids, gasoline, alcohol, oil, grease, and common solvents. This feature is not assessed by UL certification or testing.
- For use in both wet and dry applications.
- If using a tapped hole, Teflon® tape is needed on the threads of the connector, for all other applications an O-ring and Locknut are needed to attain liquid tight.
- Use of an O-ring may be required for a complete liquid tight system with a non-threaded mounting hole. See page 2-20.
- Locknuts **included** with Straight-Thru fittings.
- To order metal or nylon locknuts separately, see pages 2-17 & 2-18.
- Patented.

Quick Specs